



UIT

THE ARCTIC
UNIVERSITY
OF NORWAY

University of Tromsø The Arctic University of Norway, Faculty of Health Sciences
Department of Pharmacy – Microbiology Research Group

Experimental explorations of general patterns of epistatic interactions in clinical *Escherichia coli* isolates

Gina Pat

Supervisor: Assoc. Professor Pål Jarle Johnsen

Assistant supervisor: MSc Pharmacy/PhD-candidate Julia Kloos

Thesis for the degree Master of Pharmacy, May 2015



Acknowledgements

The work presented in this thesis was carried out in the period from October 2014 to May 2015 in Microbial Pharmacology and Population Biology Research Group, led by Associate Professor Pål Jarle Johnsen, in the Department of Pharmacy, Faculty of Health Science, UiT The Arctic University of Norway.

I would like to thank my supervisor, Pål, for your motivation, encouragement, and giving me the opportunity to be included in a positive and friendly group of people. To all members in the “micro”-group, thank you for having me there 😊.

I also want to give my gratitude towards Julia Kloos and Ane Utnes for the help, support and patience in the lab. To Vidar Sørum, thank you for taking the time explaining the calculation in Excel. This would have been impossible without your help.

To Julia, I am so thankful for your patience and the positive attitude of yours! Your empathic thoughts and encouragement towards us have been very helpful. Also, thank you for a thorough review of my thesis in the end.

My gratitude goes to my fellow students Jonathan, Lilli and Mari for many good laughs and great company. Not to mention the singing to the radio in the lab that made my time here extra enjoyable. Thank you.

At last, a special thank you to all my friends here in Tromsø for making my stay unforgettable. The biggest thank you goes to my family in Oslo for the understanding and support you have given me. Thank you, mom, for your everyday phone calls filled with love and support.



Gina Pat

Tromsø, 13th of May 2015

Abstract

Resistance towards antimicrobial agents is an increasing medical problem nowadays caused by the elimination of susceptible bacteria leaving only the resistant ones to survive and evolve. Evolution through mutations that lead to antibiotic resistance in bacteria increases the diversity of bacterial genomes. Under antibiotic treatment, these mutations might be advantageous for the bacteria, but disadvantage in the absence of antibiotic due to fitness cost. By understanding, how mutations can have an impact on the fitness cost for individual resistance determinants and the interactions that occur within one genetic background can foster our understanding of epistasis. The importance of understanding epistatic interactions between genetic determinants that are responsible for a resistant phenotype can be essential in the treatment of bacterial infections with antimicrobial drugs.

In this study, mutants of clinical *Escherichia coli* strains with reduced susceptibility towards trimethoprim and/or ciprofloxacin were generated to test whether epistatic interactions in certain combinations of mutants existed. Growth curve measurements were used to calculate the relative generation time as a measure of fitness. The result revealed that the generation time of double mutant TP+CIP22 was reduced with 7 minutes compared to the single mutant TP22, resulting in a potentially positive epistatic interaction. However, a negative epistatic interaction may have occurred due to a decrease in minimal inhibitory concentration (MIC) determined for trimethoprim in all double mutants (TP+CIP) compared to the respective single mutants (TP).

The results provided here promote our understanding of epistatic interactions in bacteria. Hopefully, together with findings of further experiments, they will be implemented in innovative guidelines for antibiotic treatment.

TABLE OF CONTENTS

1	INTRODUCTION	1
1.1	Preface	1
1.2	Antimicrobial agents.....	1
1.2.1	Antibiotic targets	3
1.3	The development of resistance to antimicrobial agents.....	4
1.3.1	Horizontal gene transfer	5
1.3.2	Mutations.....	6
1.4	The fitness cost of antimicrobial resistance and compensatory adaptation.....	7
1.5	Reversal of antimicrobial drug resistance	9
1.6	Epistatic interactions between determinants of antibiotic resistance	10
1.7	Aim and objectives	12
2	MATERIALS	13
2.1	Bacterial strains	13
2.2	Growth media	14
2.2.1	Sterilization of media and solutions	14
2.2.2	Luria Bertani broth	14
2.2.3	Luria Bertani Agar	14
2.2.4	LB agar plates with antibiotic	14
2.3	Solutions	15
2.3.1	Antibiotic stock solutions.....	15
2.3.2	Freeze stock solutions	15
2.3.3	Buffers and other solutions	15
2.4	M13 Primer.....	16
3	METHODS	17
3.1	Generation and characterization of antibiotic resistant mutants.....	17
3.1.1	Generation of single resistant mutants	17
3.1.2	Generation of double resistant mutants	18
3.2	Confirmation of mutants.....	18
3.2.1	Streak methods	18
3.3	Polymerase chain reaction (PCR).....	20
3.3.1	Template DNA for PCR.....	21
3.3.2	PCR controls	21
3.3.3	DNA fingerprinting using Randomly Amplified Polymorphic DNA (RAPD) PCR technique	21
3.3.4	DreamTaq master mix	21

3.4	Gel electrophoresis	22
3.5	Minimal Inhibitory Concentration by E-test	22
3.5.1	MIC reading using twofold dilutions	23
3.6	Growth curve measurements	24
3.7	Calculation of generation time	25
3.8	Calculation of relative generation time as a fitness measurement.....	26
3.9	Statistical analysis.....	26
4	RESULTS	27
4.1	Generation of single and double mutants	27
4.1.1	Confirmation of single and double mutants using paper strip method	29
4.2	Characterization and confirmation of <i>E. coli</i> mutants using RAPD1-PCR.....	30
4.3	Determination of Minimal Inhibitory Concentration using E-test	32
4.3.1	Classification of resistance levels in bacteria.....	32
4.3.2	MICs determined for wild type strains.....	33
4.3.3	MICs determined for single and double mutants	33
4.3.4	MICs determined for TP mutants using Ciprofloxacin E-tests	35
4.4	Growth curve and generation time	36
4.4.1	Calculation of generation time using growth curve measurements	37
4.5	Relative generation time as a measure of fitness.....	39
5	DISCUSSION	41
6	Determination of fitness cost using growth rate measurements.....	44
6.1	Possible limitations of using growth rates as fitness measurements	44
6.2	The possible reversal of antimicrobial resistance	45
6.3	Characterization of trimethoprim and ciprofloxacin resistance in <i>E. coli</i> strains.....	45
6.4	Concluding remarks.....	46
7	REFERENCES	47
8	APPENDICES	53
Appendix 1:	Tables of isolated mutants collected in this study.	53
Appendix 2:	PCR-images of single and double mutants not presented in results.	58
Appendix 3:	Growth curve OD650 measurements of mutants and wild type strains.....	60
Appendix 4:	Calculated relative generation time and significant differences	66
Appendix 5:	Molecular weight standard: SmartLadder MW-1700-10 (Eurogentec).....	67

LIST OF TABLES

Table 1: ECO-SENS strains; clinical <i>E. coli</i> isolates used in this study.....	13
Table 2: An overview over the M13 primer sequence	16
Table 3: RAPD1 thermocycler program used in this study.....	20
Table 4: overview over sample controls used in PCR.....	21
Table 5: Numbers of spontaneous single and double mutants isolated for each <i>E. coli</i> wild type strain.	28
Table 6: Clinical breakpoints adopted from EUCAST (V. 5.0, valid from 2015-01-01)	32
Table 7: Minimal inhibitory concentrations of <i>E. coli</i> wild type strains.....	33
Table 8: trimethoprim mutants and their MIC for trimethoprim.....	34
Table 9: CIP mutants and their MIC for ciprofloxacin	34
Table 10: Table of TP+CIP double mutants and their MICs for each antibiotic.	35
Table 11: MIC value for ciprofloxacin determined in TP mutants that were chosen for generating double resistant mutants.	35
Table 12: Generation time (in minutes) for TP mutants and WT strains, respectively.....	38
Table 13: Generation time (in minutes) for CIP mutants and WT mutants, respectively.	38
Table 14: Generation time (in minutes) for TP+CIP mutants and WT mutants, respectively.....	38
Table A: TP22 mutants isolated in this study.....	53
Table B: TP41 mutants isolated in this study.....	53
Table C: TP78 mutants isolated in this study.....	54
Table D: CIP22 mutants isolated in this study	54
Table E: CIP41 mutants isolated in this study	55
Table F: CIP22 mutants isolated in this study	55
Table G: TP+CIP22 mutants isolated in this study.....	56
Table H: TP+CIP41 mutants isolated in this study.....	56
Table I: TP+CIP78 mutants isolated in this study	57
Table J: Average raw data of OD ₆₅₀ growth curve readings of single mutant TP strains with the respective WT strains (technical parallel 1 and 2)	60
Table K: Average raw data of OD ₆₅₀ growth curve readings of single mutant TP strains with the respective WT strains (technical parallel 3 and 4)	61

Table L: Average raw data of OD ₆₅₀ growth curve readings of single mutant CIP strains with the respective WT strains (technical parallel 1 and 2)	62
Table M: Average raw data of OD ₆₅₀ growth curve readings of single mutant CIP strains with the respective WT strains (technical parallel 3 and 4)	63
Table N: Average raw data OD ₆₅₀ growth curve readings of double mutant TP+CIP strains with the respective WT strains (technical parallel 1 and 2)	64
Table O: Average raw data OD ₆₅₀ growth curve readings of double mutant TP+CIP strains with the respective WT strains (technical parallel 3 and 4)	65
Table P: The calculation of generation time in averages for all single and double mutants with their respective wild type strains.....	66

LIST OF FIGURES

Figure 1: Overview of trimethoprim's site of action.....	2
Figure 2: Overview of the reversal of antimicrobial drug resistance.....	9
Figure 3: Illustration of an epistatic interaction between determinants.....	10
Figure 4: The the paper strip method.....	19
Figure 5: The figure shows a quadrant streak method.....	19
Figure 6: The twofold values of the E-test used to determine the MIC value.....	23
Figure 7: 96-well was setup to measure the growth rate.....	25
Figure 8: Figure showing an example of five CIP mutant colonies streaked in sections on a LB agar plate.....	29
Figure 9: Gel picture of RAPD1-PCR products of four CIP mutants.....	30
Figure 10: Image of ten PCR samples (CIP mutants of E. coli K56-22).....	31
Figure 11: Graph illustrating the growth curve of TP mutants and respective WT strains....	36
Figure 12: Growth curve of CIP mutants and respective WT strains.....	37
Figure 13: Fitness measurements using relative generation time values for single and double mutants.....	40
Figure A: PCR fingerprints of ten random CIP mutant isolates.....	58
Figure B: PCR fingerprints of double mutant isolates (TP+CIP22, 41 and 78)..	59
Figure C: Figure illustrating molecular marker (SmartLadder) used in gel electrophoresis..	67

ABBREVIATIONS

bp	Base pairs
CIP	Ciprofloxacin resistant
ddH ₂ O	Double distilled water
DNA	Deoxyribonucleotide acid
dsDNA	Double stranded DNA
<i>E. coli</i>	<i>Escherichia coli</i>
EtBr	Ethidium bromide
E-test	Epsilometer test
HCl	Hydrochloric Acid
HGT	Horizontal gene transfer
kp	Kilo base pairs
LB	Luria Bertani-Broth Miller
MIC	Minimal Inhibitory Concentration
OD	Optical Density
ONC	Overnight culture
PCR	Polymerase chain reaction
rpm	Rounds per minute
ssDNA	Single stranded DNA
TAE	Tris/Acetate/EDTA
TP	Trimethoprim resistant
UTI	Urinary tract infection
UV	Ultra-violet irradiation
WT	Wild type
X	

1 INTRODUCTION

1.1 Preface

Bacteria adapt to changing environmental conditions during the process of evolution. Thus, they bear the potential to become a big threat to man-kind in the future due to the increased consumptions of antibiotics and the rapid development of bacterial resistance to antibiotics (Goossens et al., 2005). Antimicrobial agents are either produced by other organisms (penicillin G), through chemical modifications of existing scaffolds (EX), or completely synthetic (ciprofloxacin). When bacteria become resistant to a certain antibiotic, they in turn might become less fit compared to its susceptible counterpart when the antibiotic is not present (Andersson and Levin, 1999). Bacteria can become resistant through mutations in the genome or by receiving genetic material (encoding resistance determinants) from other organisms during horizontal gene transfer. By having the knowledge about how resistance mechanisms work in bacteria, it is therefore possible to use that knowledge to fight the rapid development of antibiotic resistance. In this study, we generated reduced susceptibility in *Escherichia coli* (*E. coli*) strains to given antimicrobial agents through spontaneous mutations and subsequently aimed to identify epistatic interactions between the different resistance determinants. We propose that if such general patterns exist in bacterial populations we can through innovative antibiotic stewardship “force” bacterial evolution along the least favorable path that may optimize reversal of resistance.

1.2 Antimicrobial agents

Alexander Fleming’s discovery of Penicillin in the 1930’s is regarded as one of the major breakthroughs in medicine. Since then, the discovery of new, innovative antimicrobial agents gave the world an opportunity to fight against infectious diseases caused by bacterial pathogens. The antimicrobial agents can be categorized in either bacteriostatic or bactericidal, depending on their effect on the bacteria: bacteriostatic antibiotics slow down the growth of bacteria by interfering with vital processes like protein synthesis. However, bactericidal antibiotics kill bacteria, for example by interrupting cell wall synthesis (Pankey and Sabath, 2004). Antibiotics can also be classified into broad spectrum antibiotics, which affect a variety of bacteria, or

narrow spectrum antibiotics that are only affecting a smaller range of bacteria (Leekha et al., 2011). Trimethoprim and Ciprofloxacin are the two antibiotics that were used in this study and are described below.

Trimethoprim is a bacteriostatic antibiotic and acts by inhibiting the folic acid synthesis in bacteria, which is necessary for the DNA (deoxyribonucleotide acid) synthesis. The drug competes with dihydrofolic acid for the enzyme dihydrofolate reductase (DHFR), which usually transforms its substrate into tetrahydrofolic acid, but not in the presence of trimethoprim (competitive inhibition, see Figure 1) (Quinlivan et al., 2000). In the treatment of urinary tract infection in Norway, it is common to combine trimethoprim with sulphonamide antibiotic sulfamethoxazol for a treatment duration of 3 days. Sulfamethoxazol also acts as a competitive inhibitor by interfering the p-aminobenzoic acid (PABA) and dihydrofolate diphosphate for the binding of dihydrofolate reductase enzyme from preventing the synthesis of folate (Rang et al., 2007). Fortunately, the inhibition of folic acid synthesis in bacteria does not affect folic acid synthesis in human, because they tend to get it through external sources like food supplements. Trimethoprim has also a much higher affinity for bacterial DHFR, making trimethoprim a drug with antimicrobial target specificity.

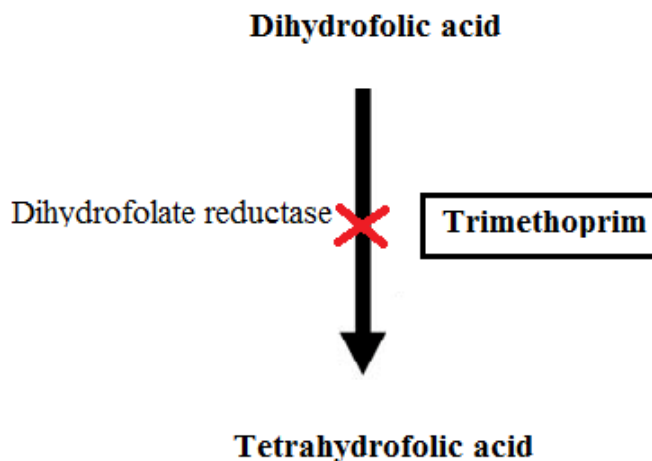

Figure 1: Overview of trimethoprim's site of action by inhibiting the dihydrofolate reductase enzyme from synthesizing the essential folic acid in bacteria.

In a study of Flensburg and Sköld, resistance of clinical *E. coli* isolates against trimethoprim was caused by an overproduction of the DHFR enzyme expressed by the *dfr* gene (Flensburg

and Sköld, 1987). However, newer study showed resistance towards trimethoprim had occurred in the efflux pump expressed by the BpeEF-OprC gene, and also mutations in DHFR could cause resistance to trimethoprim (Podnecky et al., 2013).

Ciprofloxacin belongs to the second generation of the fluoroquinolone class of antibiotics. It has a bactericidal effect by targeting DNA gyrase and topoisomerase IV, enzymes that are important for the negative supercoiling of double stranded DNA (dsDNA), and kills the bacteria by preventing DNA replication (Hooper, 1999, Yoshida et al., 1990). A study on fluoroquinolone resistance in 54 *E. coli* urinary tract infection (UTI) clinical isolates from Sweden showed that resistance towards ciprofloxacin in *E. coli* is associated with mutations in the *gyrA* gene. However, mutations in genes such as *gyrB*, *parC*, *pare*, *marOR* and *acrR* also played a role in the emergence of resistance to fluoroquinolones (Komp Lindgren et al., 2003). Spontaneous mutations in *gyrA* or *gyrB* are associated with quinolone resistance *E. coli* because DNA gyrase is encoded by the *gyrA* and *gyrB* genes (Yoshida et al., 1990). However, the majority of quinolone resistance in clinical *E. coli* isolates is caused by mutations in the *gyrA* gene (Pourahmad Jaktaji and Mohiti, 2010).

Both trimethoprim and ciprofloxacin are antibiotics that are implemented in the treatment of urinary tract infections in Norway, an infection that is most commonly caused by the Gram-negative bacteria *E. coli*.

1.2.1 Antibiotic targets

As mentioned above, antibiotics are classified as being bacteriostatic or bactericidal or alternatively narrow-spectrum or broad-spectrum antibiotics. They exhibit different targets within bacteria. The three major modes of action are: inhibition of cell wall synthesis, inhibition of DNA/RNA synthesis and inhibition of protein synthesis.

Cell wall synthesis: the structure of a bacterium's cell wall differs from whether if it is a Gram-negative bacterium or a Gram-positive bacterium. Cell wall synthesis is inhibited by the antibiotic agent interfering with important processes during synthesis of the peptidoglycan layer. Classes of antibacterial drugs that interferes with the cell wall synthesis are beta lactams, lipopeptides, glucopeptides and glycolipopeptides, reviewed in (Kohanski et al., 2010).

DNA/RNA synthesis: ciprofloxacin and trimethoprim (see 1.2 for their site of action) are antibiotics that are known to either i) inhibit the replication of DNA strands in bacteria (ciprofloxacin) or ii) competitively inhibit enzymes that are important for the synthesis of DNA precursor molecules (trimethoprim). Rifamycins are a class of antimicrobial drugs that inhibit the synthesis of RNA, reviewed in (Kohanski et al., 2010).

Protein synthesis: aminoglycosides, tetracyclines and macrolides inhibit protein synthesis in bacteria through a variety of mechanisms. Generally, their binding to the 30S or 50S ribosomal subunit prevents bacterial proteins synthesis, reviewed in (Kohanski et al., 2010).

1.3 The development of resistance to antimicrobial agents

Antimicrobial drugs are one of many drugs in the world that lose their effect on bacteria, as they are frequently over- and misused, which leads to the emergence of resistant microbes. The drugs we use to fight against nasty infections caused by pathogenic bacteria are either from chemically synthesized or occur naturally. Over the course of the 20th century, the discovery of antimicrobial agents has made dangerous infectious diseases easily treatable (Davies and Davies, 2010). However, today, the rate of development of antimicrobial drug resistance has increased significantly over the last two decades making this a worldwide medical problem (Wright, 2010, Wright, 2013). Resistance to antimicrobial drugs in the medical world is defined as: “organisms that will not be inhibited or killed by an antibacterial agent” (Mims et al., 2008). The problem lies therefore in the continuous evolution of bacteria and their adaption to the existing antibiotic agents. Using antimicrobial drugs forces the bacteria into a selective pressure by killing or growth inhibition of susceptible bacteria. The development and spread of resistance to antibacterial agents occurs in several ways, however, in this thesis I will describe two main processes: 1) by receiving a resistant gene through horizontal gene transfer or 2) by chromosomal mutations (Normark and Normark, 2002, Martinez, 2014).

1.3.1 Horizontal gene transfer

As bacteria exposed to an antibiotic for which they are susceptible for will die, resistant ones increase in number due to profitable spatial and nutritional conditions for survival and also by sharing their resistance determinants with other bacteria through mechanisms such as horizontal gene transfer (HGT)(Jain et al., 1999). Mechanisms of HGT in prokaryotic cells include the uptake of foreign DNA and subsequent incorporation into the recipients' own genome. Expression of the newly acquired DNA may, at best, lead to a beneficial phenotypic trait, such as resistance to antibiotics. The transfer can occur between different bacterial species. There are many ideas about why HGT occurs, this is however not the topic of the thesis. A major consequence of HGT is the spread of adaptive traits such as antibiotic resistance genes between bacteria (Koonin et al., 2001). The three mechanisms by which bacteria can obtain foreign DNA are termed transformation, transduction and conjugation. However, there was a recent study that stated a fourth mechanism of HGT: Outer membrane vesicles (Fulsundar et al., 2014).

1.3.1.1 Transformation

Transformation occurs when a bacterial cell takes up foreign DNA from its environment by actively bringing that DNA across its plasma membrane eventually integrating it into the genome (Thomas and Nielsen, 2005). A competent (recipient) cell takes up the foreign DNA from its environment and the DNA is then integrated into the genome through recombination (Redfield, 1988). Only a small fraction of the bacteria species, ca 60 species are naturally competent, reviewed in (Johnsborg et al., 2007). The first discovery of a natural competent bacterial cell was in *Streptococcus pneumoniae* by Griffith (Griffith, 1928).

1.3.1.2 Transduction

Bacterial viruses/bacteriophages mediate transduction by attaching themselves to bacterial cells and inject their genetic material into the cytoplasm of the recipient bacterium, reviewed in (Frost et al., 2005). Bacteriophages (donor) use the recipient bacteria as their host to generate new phage particles by incorporating the phage DNA into the recipients' DNA (Koonin et al.). The virus is then dependent on the host bacteria for the replication of new phage particles. The new phage particles emerge from their host; some may carry pieces of bacterial DNA. If the new bacteriophages attach to other bacteria and the DNA becomes incorporated into the recipient genome, new genotypes of bacteria arise (Frost et al., 2005).

1.3.1.3 Conjugation

Conjugation is a common mechanism for spread of antibiotic resistance determinants and involves the transfer of genetic information through cell-to-cell contact. The transmission of genetic elements like plasmid-DNA occurs between a donor cell and a recipient cell. The genetic material could either be a copy of a plasmid or other elements like transposons associated to a conjugative function, reviewed in (Brown-Jaque et al., 2015). These elements are known to be mobile genetic elements that can implement the transfer of DNA between bacterial cells. The transmission takes place after the bacterial cell grows a duct (pilus) and attaches it to the other bacterium. Conjugative elements such as plasmids traverse the cell wall and plasma membrane through pores connecting donor and recipient (Chen et al., 2005).

1.3.2 Mutations

Mutations, also known as *de novo* genetic changes (Low et al., 1999), are changes that occur randomly in the DNA sequence and can either be neutral, harmful or advantageous for the bacterium (Sniegowski et al., 1997). This kind of changes give the organism an opportunity to generate genetic diversity allowing the change to be beneficial for further evolution by having the chance to adapt and survive better in the environment (Metzgar and Wills, 2000). Most mutations that happens naturally are rather deleterious for the organism than beneficial. However, some of the mutations can be beneficial for the bacterium, for instance, rendering it resistant to a certain antibiotic.

1.3.2.1 Chromosomal-mediated resistance

Chromosomal-mediated resistance are mutations that occurs through spontaneous mutations enriched during antibiotic exposure of bacteria. Mutations in different sites in the chromosome can result in different types of resistance mechanisms depending on the species of the bacterium and the antimicrobial agent used. For example, a mutation that lead to an increased or decreased synthesis of an altered protein that can supress the effect of an antibiotic agent (Mims et al., 2008).

1.4 The fitness cost of antimicrobial resistance and compensatory adaptation

Fitness is described as “the capability of a genotype or individual to survive and reproduce” (Andersson and Hughes, 2010) and therefore determines its evolution. It is assumed that a mutant bacterial strain is less fit compared to its respective wild type (Andersson and Levin, 1999). Even though bacteria have the capability and developed resistance to all currently employed class of antimicrobial agents, the cost for having the resistance gene can be high for the resistant bacteria, particularly immediately after the acquisition (Schrag et al., 1997, Starikova et al., 2013). Consequently, the resistant strain is prone to be outcompeted by other sensitive strains if the environment is representative for the susceptible bacteria. That may result in a slower growth in the resistant strain compared to the sensitive strain (Low et al., 1999). There are studies that show a reduction in fitness when carrying a resistance trait obtained either by a plasmid transfer or by a mutation (Starikova et al., 2013, Starikova et al., 2012, Johnsen et al., 2002). The reason why antimicrobial resistance determinants are often costly for the bacteria is due to the possible negative effects of mutation, like the extra burden of synthesizing a protein that leads to microbial resistance to a certain antibiotic (Zu and Lebek, 1980, Jin and Gross, 1989).

Fitness can be measured in absolute fitness and relative fitness. Absolute fitness defines the absolute growth of the resistant strain and the growth of the wild type strain whilst relative fitness is the ratio measured from the absolute fitness of the resistant strain and the ancestral strain (Bennett and Lenski, 1993).

Compensatory adaptations describes mutational changes within or outside a resistance determinant that increases the resistant bacterial relative fitness without loss of the resistant phenotype. Through a second mutation, the initial biological fitness cost of resistance expression (usually engendered in the absence of antibiotic selection pressure) will decrease without loss of resistance (Normark and Normark, 2002). Another example would be, if a wild type organism undergoes detrimental mutational changes, that mutation will most likely lower the fitness of that organism (Andersson and Levin, 1999). However, one additional mutation could have the effect of increasing the organisms' fitness (Björkholm et al., 2001). This will help the organism to compensate a detrimental mutation. It is possible to have more than one compensatory mutation; in fact, multiple compensatory mutations can slowly build up the fitness back to where it was (Andersson, 2006). As mentioned above, compensatory adaptations provide an increase in fitness only in the presence of other mutations.

1.5 Reversal of antimicrobial drug resistance

To a certain extent, the reversal of antimicrobial drug resistance in bacteria is possible when the antimicrobial drug is removed. This is due to the fitness decrease in resistant bacteria: in an antibiotic free environment susceptible bacteria outcompete the resistant ones (Andersson and Levin, 1999). However, there has been a study showing that the withdrawal of the antimicrobial agent did not decrease the resistant frequency among *E. coli* (Enne et al., 2001). In Figure 2, Johnsen and his team has made an illustration on how the reversal of antimicrobial drug resistance occurs (Johnsen et al., 2009).

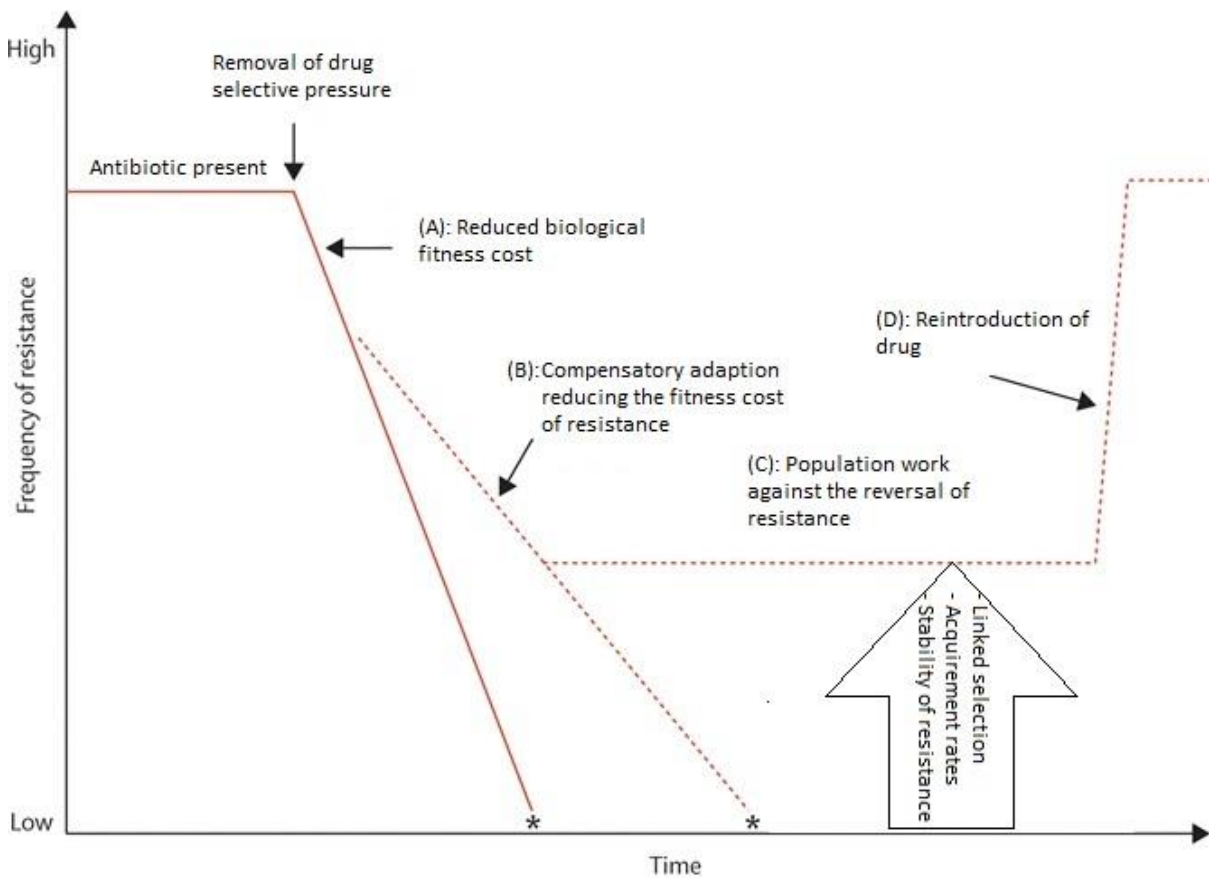

Figure 2: Overview of the reversal of antimicrobial drug resistance. This figure shows that the frequency of resistance is high when the antibiotic is present, however, when the drug is removed, a selective pressure occurs among the resistant bacteria making the frequency of resistance drop significantly due to reduced fitness cost (A) when the compensatory evolution is not present. In case (B), the presence of compensatory evolution is making the bacteria more fit, the reversal of antimicrobial drug resistance is taking much longer time compared to case (A). Other factors may play a part in preventing the resistance frequency to decrease through linked selection, stability of resistance or/and acquisition and transfer as shown in case (C). However, if the antibiotic is reintroduced (D), the frequency of resistance in bacteria will immediately go back to where it was in the beginning. (Adopted and modified from (Johnsen et al., 2009)).

1.6 Epistatic interactions between determinants of antibiotic resistance

The term epistasis was first mentioned by a biologist, William Bateson, over 100 years ago, reviewed in (Phillips, 2008). Epistasis is a way for bacteria to develop genetic diversity through genetic interactions that determine the bacterial phenotype (Cordell, 2002). In addition, epistasis play a big part in the evolution of developing resistance towards antimicrobial agents. In our study, epistasis can be explained by Figure 3.

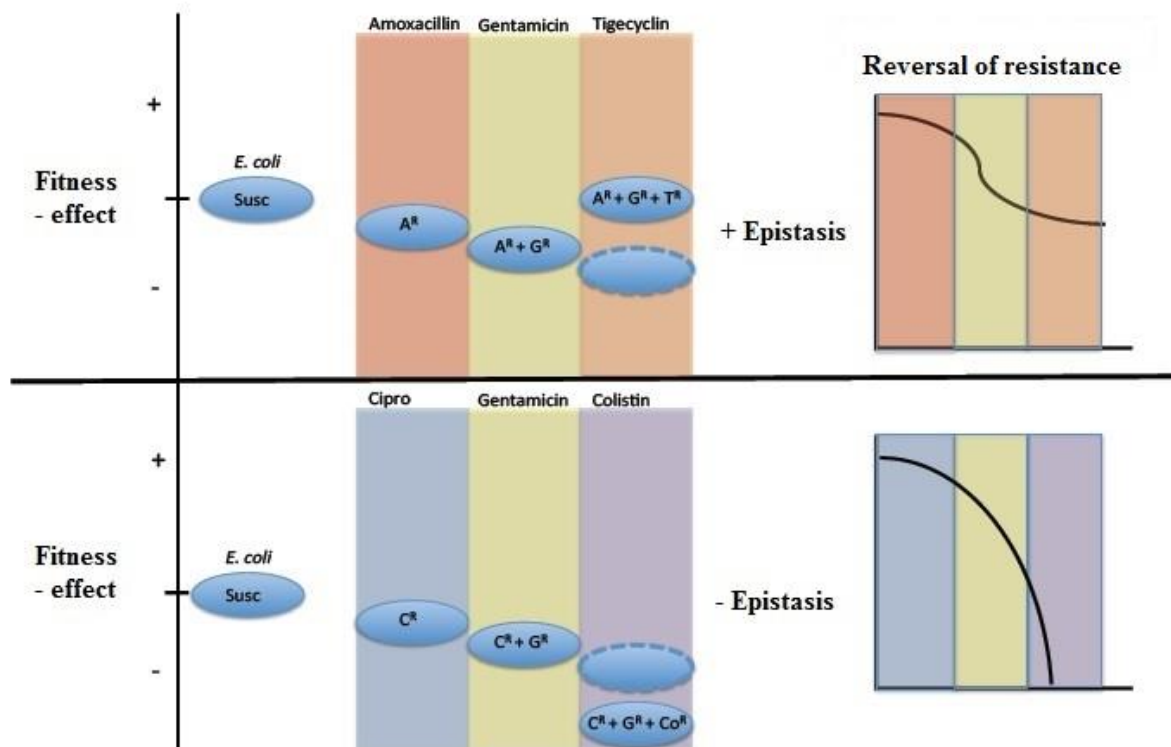

Figure 3: Illustration of an epistatic interaction between determinants of antibiotic resistance. Susceptible *E. coli* strain developing resistance towards three antibiotic agents. For each gene interaction occurring after resistance acquisition, there will either be a positive epistatic effect (+ Epistasis) or a negative epistatic effect (- Epistasis). The expected theoretical outcome is shown as a dashed “empty” box. The more resistance traits (X^R) *E. coli* accumulates during time for different antibiotic agents, the less fit the bacteria become. Positive epistasis is represented when the fitness of the bacteria suddenly gets significantly higher than the previous starting point and the reversal of resistance (graph shown to the left) would decrease, and takes much longer time. The opposite happens through negative epistasis when the fitness of the bacteria is reduced significantly after the development of resistance to a third antibiotic agent, however, the reversal of resistance would decrease remarkably compared to the positive epistasis (figure modified and provided by P. J. Johnsen).

The term epistasis can be very complex to interpret. Epistasis describes the biological concept of gene interactions in organisms. By understanding epistatic interactions, it may be possible to map a pattern of antimicrobial resistance development/evolution, triggered either by mutations or by mobile genetic elements (MGE) for clinical use (our study). From clinical point of view, if epistatic interactions can be predicted it could allow us to propose optimized temporal consumption patterns that could in theory “force” microbial evolution along the least favourable evolutionary path. In our study, epistasis can be defined in terms of magnitude epistasis and sign epistasis.

Magnitude epistasis can be defined as synergistic or antagonistic. The effect of synergistic (positive epistasis) interactions from a relative fitness perspective mean that the net effect of two or more resistance determinants in the same genetic background is lower than if they were in individual cells, reviewed in (zur Wiesch et al., 2011). The opposite effect is seen in antagonistic (negative epistasis) where the combined effect of two or more detrimental mutations on fitness are higher than if present in single genetic backgrounds (Khan et al., 2011) (see Figure 3 for illustration).

Sign epistasis happens in the presence of a single mutation, that can have either a beneficial or a deleterious effect, and a second mutation which is present depending on a certain genetic background of the bacteria (Trindade et al., 2009). A study showed that when a bacterial strain carried a chromosomal mutation together with a resistant plasmid, this strain was much fitter compared with its respective resistance determinants (Silva et al., 2011). They also found out that epistasis that occurs naturally is not gene specific, but rather allele specific. Compensatory adaptation is an example of sign epistasis (see 1.4).

In theory, the fitness cost of bacterial mutations in the genome can be combined additively (as illustrated in Figure 3). For instance, an additive effect is identified when two mutations describe a sum that was added up based on single mutations. The additive effect is therefore predictable, but it is harder to predict when an epistasis interaction occurs.

1.7 Aim and objectives

Project idea

The project idea is to “*identify temporal patterns of drug use that maximize the fitness costs of multi-resistance E. coli isolates*” (project description P. J. Johnsen).

Aim

Find a way to combine different antimicrobial agents for innovative antimicrobial treatment against uncomplicated UTI caused by *E. coli*.

Hypotheses

General patterns of negative epistatic interactions exist between certain combinations of antibiotic resistance determinants- and these can be explored in the design of novel antibiotic consumption guidelines.

Specific objectives

1. To see if the additive effect of resistant genes has the potential to cause an epistatic interaction with single or double mutants.
2. To determine the fitness of the organism that carries a resistance determinant relative to the wild type strain

2 MATERIALS

2.1 Bacterial strains

The strains used in this study, presented in Table 1, were used to generate antibiotic resistance mutants and for further fitness competitions assays. Eighty clinical *E. coli* isolates from the ECO-SENS collection (provided by Ørjan Samuelsen, UNN, Tromsø) were immediately frozen down as freeze stock cultures. This collection of *E. coli* isolates originated from patients with uncomplicated urinary tract infection (UTI). The isolates were collected from four different countries in Europe (Sweden, UK, Greece and Portugal). The isolates can be divided into ECO-SENS 1 or ECO-SENS 2 collections depending on when they were obtained (Kahlmeter, 2000, Kahlmeter and Poulsen, 2012). The *E. coli* isolates were also divided into phylogenetic groups, which can be categorized into four main parts: A, B1, B2 and D (Clermont et al., 2000).

Table 1: ECO-SENS strains; clinical *E. coli* isolates used in this study

Name of strains	Phylogenetic group	From
K56-22	B2	Sweden (1999-2000) ECO-SENS 1
K56-41	D	Greece (2007-08) ECO-SENS 2
K56-78	A	United Kingdom (2007-08) ECO-SENS 2

2.2 Growth media

2.2.1 Sterilization of media and solutions

All media and solutions used in this study were autoclaved at 121°C for 20 minutes (Certoclav, Getinge).

2.2.2 Luria Bertani broth

Luria-Bertani Broth, Miller (LB) contained 10 g of tryptone, 5 g of yeast extract and 10 g sodium chloride per litre of distilled water. LB is the base for the maintenance and propagation of *E. coli*. 20 g of LB powder were dissolved in 800 ml distilled water followed by autoclavation. The LB medium was stored at room temperature.

2.2.3 Luria Bertani Agar

In this study, solid LB was prepared by adding 12 g of Select agar (Sigma-Aldrich, Germany) into 800 ml of LB solution. LB agar was autoclaved before use. 800 ml of LB agar resulted in approximately 40 plates.

2.2.4 LB agar plates with antibiotic

For preparations of selective LB agar plates that contained the desired antibiotic concentration, antibiotic stock solution was only added into the autoclaved LB agar when the temperature was cooled to 50-60°C to prevent destruction of the antibiotics. This applied to all antibiotics that were used in this study. Trimethoprim LB agar plates were prepared by adding the necessary volume of 100 mg/ml trimethoprim stock solution (provided by Julia Kloos). Trimethoprim plates were made in the following concentrations: 4, 8, 16 and 32 µg/ml. Ciprofloxacin LB agar plates were made from a 10 mg/mL ciprofloxacin stock solution in the following concentrations: 0.1 and 0.25 µg/ml. The concentrations were determined according to the minimal inhibitory concentration (MIC) value performed on the three ancestor strains (K56-22, 41 and 78) of *E. coli* (see Table 1).

2.3 Solutions

2.3.1 Antibiotic stock solutions

The antibiotic stock solutions were stored at -20°C when not in use and only thawed 30-60 minutes before preparation of the LB agar plates. 0.1 g of ciprofloxacin (BioChemika, Sigma-Aldrich) were mixed with 10 ml of distilled water in a sterile 45 ml falcon tube (BDTM Falcon, USA). Mixed the content using a vortex machine, followed by adding 9-10 drops of hydrochloric acid (HCl) 3.7% (provided by Ane Utnes) for the ciprofloxacin powder to dissolve in the distilled water, resulting in a 10 mg/mL ciprofloxacin stock solution. The solution was then sterile filtered through a syringe filter (25 mm, Acrodisc®) directly into a sterile falcon tube (10 ml). No pH adjustments were done. The trimethoprim stock solution was provided beforehand (100 mg/ml in dimethyl sulfoxide (DMSO), Aldrich, Germany).

2.3.2 Freeze stock solutions

A freeze stock solution was prepared using LB media amended with 25% glycerol in a Falcon freeze tube (VWR International, USA). A sterile, single-use-1 μL loop was filled with generous amount of selected bacteria and suspended into the freeze stock solutions. To make sure that most of the collected bacteria were resuspended, the tubes were vortex before freezing down. The strains were frozen down at -75°C for long-term storage and further experiments.

2.3.3 Buffers and other solutions

Buffers and other solutions that were necessary for this experiment are listed below. Most of the solutions and buffers were already made beforehand, and these were most often made from a general protocol in the lab to carry out basic methods (Sambrook and Russel, 2001) .

0.9% NaCl (saline solution) was made by dissolving 9 g sodium chloride (NaCl) (Sigma-Aldrich, Germany) in 1 litre of demineralized water followed by autoclavation at 121°C for 20 min.

Glycerol 50% was mainly used for the freeze stock solution and was made by dissolving 57.5 ml of glycerol 86-88% (Sigma-Aldrich, Germany) with 42.5 ml of demineralized water giving a total volume of 100 ml. The glycerol was autoclaved and stored at room temperature.

1xTAE buffer (Tris/acetate/EDTA) was used for gel electrophoresis and preparation of agarose gel. 1xTAE was diluted from 50xTAE stock solution with demineralised water. 50xTAE was already made beforehand. No autoclavation was needed.

Loading buffer (6X) is a blue solution used in polymerase chain reaction to keep the DNA samples in the bottom of the well and for visualizing how far the DNA sample has gone when running the gel electrophoresis. This blue loading dye was made beforehand.

2.4 M13 Primer

The primer used in this study was the M13 RAPD-PCR primer (Sigma-Aldrich, Germany). According to the manufacturer, the freeze-dried primer was prepared by dissolving it with ddH₂O (double distilled water) to a concentration of 100 µM before use. The primer was stored at -20°C in liquid form. For the experiment, the primer was diluted to a 5 µM solution by mixing 5 µL of M13 primer (100 µM) with 95 µL ddH₂O resulting in a total volume of 100 µL.

Table 2: An overview over the M13 primer sequence

Name	Sequence 5' – 3'
M13	GAGGGTGGCGGTTCT

3 METHODS

3.1 Generation and characterization of antibiotic resistant mutants

3.1.1 Generation of single resistant mutants

The most reasonably way to generate mutants resistant to one certain antibiotic, was to expose the strains to the antibiotic and whichever strain managed the exposure to the antibiotic would most likely grow due to decrease in susceptibility towards the respective antibiotic. These will be collected for further characterization.

The three *E. coli* strains (K56-22, 41 and 78) that were included for this experiment were streaked on sterile LB agar plates directly from the ECO-SENS freezing stock collection and incubated for 16-18 hours at 37°C. To prepare an overnight culture (ONC) one single colony from the LB plate was used to inoculate 35 mL of LB medium in a sterile 100 ml flask. A negative control was incubated containing the same LB (3 mL in sterile glass tube). Both, the negative control and the ONC were incubated for 16-18 hours (150 rpm, 37 °C). Incubation between of 16-18 hours results in a cell number of approximately 10⁹ cells/ml. 10 ml of the ONC was distributed into falcon tubes (volume 45 mL) and the contents were centrifuged at 4000 rpm for 10 minutes. The pellet that remained in the bottom of the falcon tube was kept whereas the supernatant was discarded. 1 mL of fresh liquid LB was used to resuspend the pellet, and 100 µL of the pellet solution were plated per LB plate with the required antibiotic concentration (in totalt 10 plates/experiment). Trimethoprim 100 mg/mL and ciprofloxacin 10 mg/mL were used to generate single resistant mutants. All the plates were incubated at 37°C until visible colony growth (maximum 3 days of incubation). Approximately ten mutant colonies per strain were randomly selected for further assays.

3.1.2 Generation of double resistant mutants

The generation of double resistant mutants was performed in exactly the same way as the generation of single resistant mutants (see 3.1.1). The method included the exposure of those mutants, which already carried a resistance mutation for either trimethoprim or ciprofloxacin, to the other antibiotic, respectively. In this study, trimethoprim resistant *E. coli* mutants were plated on selective plates containing the desired concentration of ciprofloxacin (as described in 2.2.4). The generation of double resistant mutants was applied to all three trimethoprim resistant *E. coli* mutant strains (K56- 22, 41 and 78).

3.2 Confirmation of mutants

To verify the mutant colonies growing on antibiotic LB agar plates as *E. coli* mutants, ten colonies were randomly selected per strain growing on the desired antibiotic LB agar plates. Marking the new plates with the same antibiotic concentration into sections, the colonies that were selected, were streaked on each given sections together with a wild type strain as a negative control (see Figure 4 for illustration) and the plates were incubated for 24 hours at 37°C. This type of control showed whether the mutants selected for further characterization would grow again when the same antibiotic pressure was present. By comparing the mutants' growth with the growth of the wild type strain (no growth expected wild type strain = negative control) false mutants could be detected.

3.2.1 Streak methods

The paper strip method: This method was used to collect small colonies. To ensure that only the colony was touched the corner of a sterile paper strip was used to pick a single colony. This method was also used to confirm whether or not the selected colonies were mutants by comparing the growth with a negative control as mentioned in the last section 3.2.

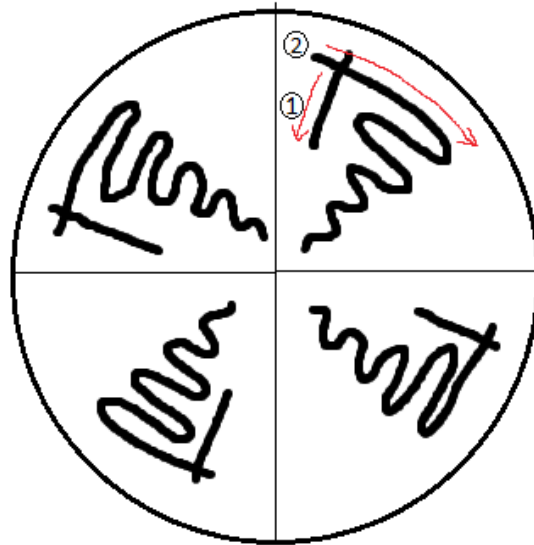

Figure 4: This illustrates the paper strip method starting with point one (1) following the direction of the arrow making one streak and from that streak, the second (2) streak follows a zig-zag motion.

Quadrant Streak Method: This method was often used to streak bacteria from a freeze stock on a fresh LB agar plate for further experiments. New streaks were made every week starting from the respective freeze stock (see Figure 5).

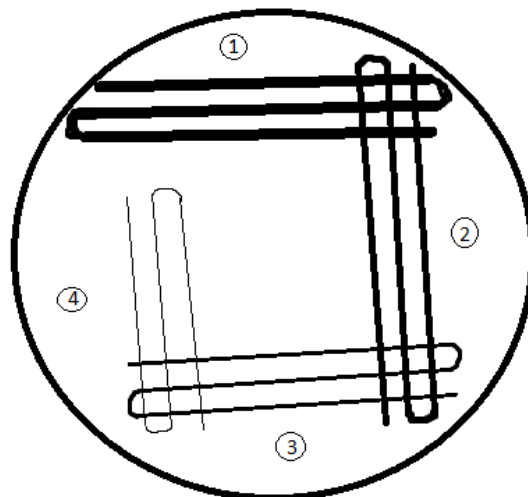

Figure 5: This figure shows a quadrant streak, which was performed on a LB agar plate. The bacterial growth is at its densest on the first (1) streak, however after the second (2) and the third streak (3), the less dense the growth will become. On the last streak (4), single colonies will most likely appear.

3.3 Polymerase chain reaction (PCR)

To confirm all the mutants that were generated for the purpose of *E. coli* being resistant to the antibiotics used in this study, all of the mutants from each strain that were isolated for further experiments needed to be confirmed as *E. coli* before being frozen down. PCR has become the most commonly used method to amplify a specific DNA sequence into millions of copies for genetic characterizations (Mullis, 1990). The PCR-machine is a programmable heating block that alternates between different temperatures in the following three main cycles: 1) denaturation of the double stranded DNA into single stranded DNA (ssDNA) at 95 °C. 2) annealing step at a temperature can vary from 36-60 °C, allowing the primer to bind to the specific complimentary site on the ssDNA for further amplifications, and 3) elongation of the ssDNA into dsDNA using a heat-resistant DNA polymerase to attach the four deoxyribonucleotide tri phosphates (dATP, dCTP, dGTP and dTTP) onto the ssDNA strand- at 72 °C. The cycles were repeated using the newly created dsDNA as a template for further formation of the same DNA sequence, resulting in an exponential generation of the specific DNA sequence. The PCR-reactions were carried out using the RAPD-1 thermocycler program shown in Table 3:

Table 3: RAPD1 thermocycler program used in this study

Step	Temperature	Duration
1	95 °C	5 min
2	95 °C	1 min
3	36 °C	1 min
4	72 °C	2 min
5	Repeat 2-4	45 times
6	4 °C	Forever

3.3.1 Template DNA for PCR

Each DNA template was prepared by resuspending several single colonies, harvested with a sterile 1 µl loop in 50 µL of ddH₂O (double distilled water). The suspension was mixed using a vortex machine.

3.3.2 PCR controls

Three controls were included in this experiment and are listed in Table 4:

Table 4: overview over sample controls used in PCR

Control type	Bacteria species	Origin/component
Positive control	Wild type <i>E. coli</i>	ECO-SENS
Negative control	<i>Acinetobacter baylyi</i>	(Nielsen et al., 1997)
Water control	-	ddH ₂ O

3.3.3 DNA fingerprinting using Randomly Amplified Polymorphic DNA (RAPD) PCR technique

In this study, RAPD PCR was used to analyze the DNA fingerprinting in the mutated *E. coli* strains. RAPD can be explained by the citation: “RAPD markers can also provide an efficient assay for polymorphisms, which should allow rapid identification and isolation of chromosome-specific DNA fragments.” (Williams et al., 1990). RAPD PCR was run on all strains K56- 22, 41 and 78 mutants for characterization (see Appendix 1: all mutants isolated in this study).

3.3.4 DreamTaq master mix

DreamTaq master mix 2x (Thermo Scientific™, Norway) was used when running the RAPD PCR program. According to the manufacturer, the solution contains a total volume of 1,25 ml which includes: DreamTaq DNA polymerase, 2x DreamTaq buffer, dNTP's and 4 mM mgCl₂.

Each PCR tube (volume 0.2 ml) contained 15 μ l Master Mix, 5 μ l M13 primer (5 μ M), 3 μ l ddH₂O and 2 μ l of DNA template. The RAPD-1 thermocycler program was used (see Table 3).

3.4 Gel electrophoresis

Gel electrophoresis is a lab technique for separation of DNA or proteins based on their size. An electrical field passing through the gel will make the DNA move from cathode (negatively charged) to anode (positively charged) where the oxidation is taking place. DNA has a negatively charged backbone because of all the phosphate groups allowing the DNA to travel towards the positively charged end. 1xTAE buffer covering the whole gel was used to conduct the electricity. 2% agarose gel was prepared by dissolving 2 g agarose (Seakem® LE agarose) in 100 ml 1xTAE buffer and microwaved until the agarose was dissolved. 20 μ l ethidium bromide (EtBr) (1 mg/ml stock solution, Sigma Aldrich, Germany) was added into the agarose after the solution had cooled down to 50-60 °C. The gel was poured directly into the electrophoresis chamber (20x15 cm) and allowed it to harden for 20-30 minutes. The EtBr will fluoresce when exposed to the Ultra-Violet (UV) light making the bands visible. 10 μ l of PCR product is mixed with 2 μ l loading buffer (6x). A molecular marker (SmartLadder) was added in the first and the last well as a reference since the sizes of the fragments were known. Each well was filled with 10 μ l of finished PCR product and the same applied to the ladder. The gel was run for one hour at 90 volt. All the gels were visualized in the Gel Doc 2000 Trans illuminator (BioRad, Norway) using the software Quantity One (BioRad, Norway).

3.5 Minimal Inhibitory Concentration by E-test

E-test (epsilometer test) was used to determine the antibiotic susceptibility of the strains, more specifically their minimal inhibitory concentration (MIC) (Brown and Brown, 1991). The thin plastic strip contained a gradient of antibiotic, in this case, both trimethoprim and ciprofloxacin E-tests had a concentration from 0.002 - 32 mg/L (Liofilchem®, Italy).

One single bacterial colony was suspended in 3 ml of saline (0.9% NaCl) until a McFarland of 0.5 was achieved. The E-test was performed on a regular LB agar plate by using a sterile cotton tip to spread the 0.5 McFarland solution on the plate. The E-test strip was carefully placed in the centre of the plate. All the plates were incubated at 37°C for 16-20 hours before the MIC

value was determined. The E-test was determined for the wild type strains (shown in Table 7) to estimate at which antibiotic concentration LB agar plates should be prepared for generation of antibiotic resistant mutants. The mutants generated from each strain were also tested again by E-test to see if the MIC value had changed. The strains' MIC values for ciprofloxacin and trimethoprim were determined.

3.5.1 MIC reading using twofold dilutions

All MIC readings was being determined according to the E-test principle by Citron and his team and wrote in their paper saying: *“The E-test MICs that were between the standard twofold dilution steps were rounded to the next higher step for comparison with agar dilution MICs.”* (Citron et al., 1991). For instance, a MIC determined to be 0.38 µg/ml on E-test can be rounded up to the nearest twofold dilution, which would be 0.5 µg/ml in concentration (see Figure 6).

E-test (µg/ml)
32
16
8
4
2
1
0.5
0.25
0.125
0.063
0.031
0.016
0.008

Figure 6: This figure illustrates the twofold values of the E-test used to determine the MIC value of the mutant and wild type strains used in this study

3.6 Growth curve measurements

In this experiment, the following strains were used to generate growth curves:

- 1) TP mutants (K56-22, 41 and 78) vs wild type strains (K56- 22, 41 and 78)
- 2) CIP mutants (K56-22, 41 and 78) vs wild type strains (K56- 22, 41 and 78)
- 3) TP + CIP mutants (K56-22, 41 and 78) vs wild type strains (K56- 22, 41 and 78)

Growth curve measurements were used to determine relative fitness for each mutant-versus-wild type-combination and conducted with 2x4 parallels for each combination resulting from two readings (two biological replicates). For the overnight cultures, wild type strains (K56- 22, 41 and 78) and respective mutant strains (K56- 22, 41 and 78) freeze stock cultures were used to inoculate 2 ml of LB. Incubation for 16 hours followed (37 °C, 150 rpm). A dilution of 1:2000 was prepared for this experiment by mixing 100 µl of the overnight culture with 9.9 ml of saline (NaCl 0.9%) resulting in a 1:100 dilution. Further on, 500 µl of the 1:100 dilution was diluted with 500 µl of saline (1:2 dilution) into Eppendorf tubes (2 ml) resulting in a 1:200 dilution. A clear 96-well microtiter plate (volume per well = 0.2 ml, BD Falcon™, USA) was filled with 180 µl of liquid LB (8 parallels x 6 rows) and the last 2 rows x 6 parallels with 200 µl as blank control. The three first rows (from top to bottom) were filled with 20 µl of 1:200 dilution (resulting in a final dilution of 1:2000) with the respective mutant (per wild type strain) that was chosen for measuring the growth, and the same applied to the wild type strains and the remaining rows. For the parallels, the four first wells (from left to right) where filled with the first replicate and the remaining four wells were filled with the second replicate (see Figure 7 for setup). The outermost wells remained empty due to expected medium evaporation. All microtiter plates were incubated at 37°C for a total of 24 hours. OD (Optical Density) measurements were taken every 20 minutes at a wavelength of 650 nm. The plates were shaken between readings (constant shaking for 16.65 minutes). This resulted in 73 reads in total. The measurements were saved as txt.-documents and used as raw data in Excel for calculation of the growth rate. The experiment was performed using the VersaMax® Microplate Reader and the software SoftMax™ Pro (version 5.4.1, Molecular Devices, USA).

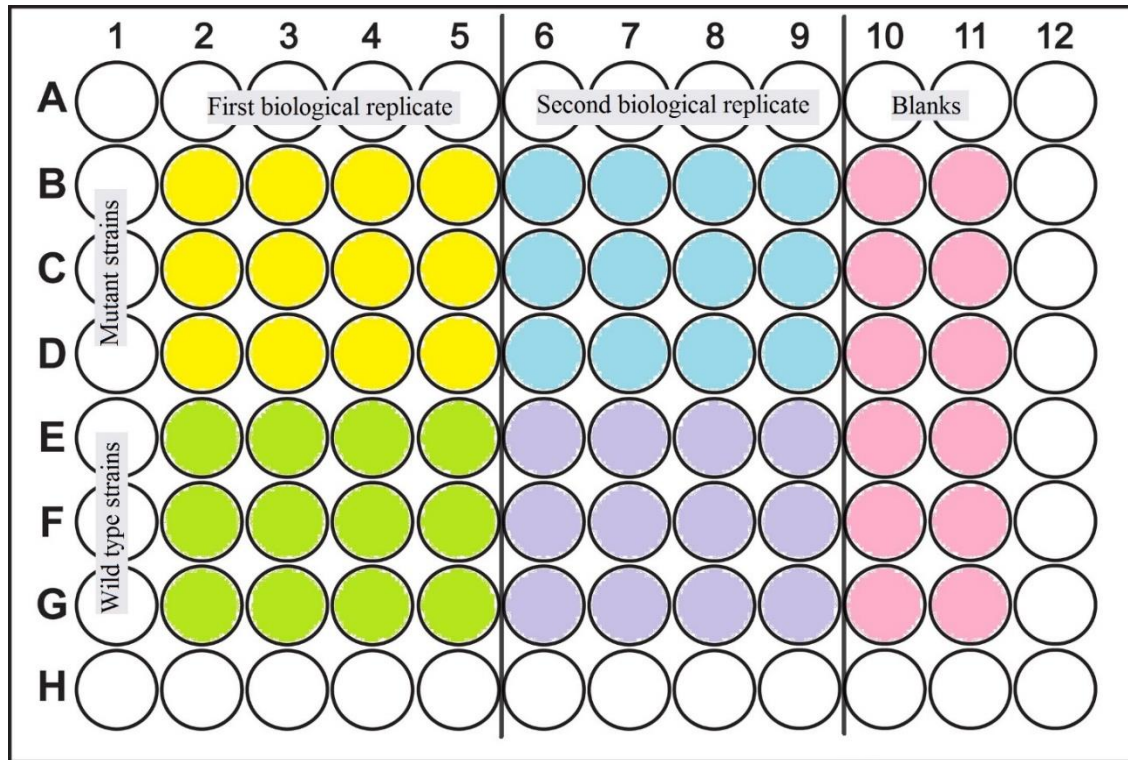

Figure 7: Illustrating with colours on how the 96-well was setup in this experiment to measure the growth rate between the mutant and the wild type strains.

3.7 Calculation of generation time

The growth rate was calculated for every readings from each strains (both mutants and wild type strains) using the following equations:

$$(1) \text{ Growth rate} = \text{slope} = \frac{\log(N_1) - \log(N_0)}{t_1 - t_0}$$

$$(2) \text{ Generation time} = \frac{\log 2}{\text{slope}} \quad \text{slope} = \frac{(t_1 - t_0) * \log 2}{\log\left(\frac{N_1}{N_0}\right)}$$

$$(3) \text{ Number of generations (n)} = \frac{\log(N_1) - \log(N_0)}{\log 2 \text{ or } 0,301}$$

N_1 is the final cell number and N_0 is the initial cell number resulting in a linear logarithmic plot. N_0 represents the lowest point on the linear plot whereas the N_1 represents the highest

point. T is time (hours or minutes) of exponential growth and t_1 and t_0 is expressed the same way as $N_{(1,0)}$.

3.8 Calculation of relative generation time as a fitness measurement

In this study, the fitness are determined using the generation time due to individually growth curve measurement and not direct competition assays. The generation time was calculated for each mutant and wild type strains that were selected to measure the growth curve (see 3.7). Generation time is the time it takes for the bacteria to double using the exponential phase of growth.

Relative generation time: Average for each mutant strain was being calculated before determining the relative generation time using the following equation:

$$(4) \text{ Relative generation time} = \frac{\text{Wild type strain's generation time (minutes)}}{\text{Mutant's generation time (minutes)}}$$

Relative generation time > 1 means that the wild type strain has a shorter generation time compared to the mutant strain. When relative generation time < 1 it means the mutant strain has a shorter generation time. A relative generation time = 1 means there is no difference in the generation time. The shorter the generation time the higher the fitness, it takes less time to get out of the lag phase and reach the exponential phase of the growth curve. The relative fitness was calculated in minutes as the concept of time.

3.9 Statistical analysis

The growth curve experiment was carried out with at least four biological replicates. The calculation of averages, standard deviations, standard errors and 95% confidence intervals for each replicate was performed in Microsoft Excel 2013. A two-tailed student test (t-test) was also performed in Microsoft Excel 2013 having the p -value with α set to 0.05 as type I error.

4 RESULTS

To test the main hypothesis this study, the generation, confirmation and characterization of spontaneous mutants, with reduced susceptibility to selected antimicrobial agents, was essential. In the following section, results from MIC and -fitness measurements of wild type and mutant strains using growth curves to calculate generation times can be found in this part of the thesis.

4.1 Generation of single and double mutants

According to the MICs of the *E. coli* wild type strains (see section 2.2.4). Trimethoprim plates in a concentration of 4, 8, 16 and 32 µg/ml and ciprofloxacin plates in concentration of 0.1 and 0.25 µg/ml, were prepared for the generation of spontaneous mutants. Table 5 shows an overview of all mutants isolated in this study. Mutants were selected for based on the physical characteristics of *E. coli* growth such as the colony color, size, and smell. The colony size differed depending on length of incubation. The longer the incubation time, the larger the colonies grew. Most colonies were preferably selected from the highest antibiotic concentration possible as long as there was a visible growth.

Trimethoprim resistant mutants: most colonies were selected from plates amended with trimethoprim in a concentration of 4, 8 and 16 µg/ml. Using the concentration of 32 µg/ml yielded very little or no growth. Since the concentration of 32 µg/ml trimethoprim in agar medium clearly exceeded the MIC for this antibiotic in the respective *E. coli* wild type strains and no spontaneous mutants were yielded at this concentration. The aim was to isolate mutant colonies from the highest antibiotic concentration possible. Here, at concentration of 16 µg/ml trimethoprim showed to be ideal to generate spontaneous resistant mutants. Most colonies could already be detected after one day of incubation at 37°C and after two days, most of the colonies were large enough to be isolated for further characterization.

Ciprofloxacin resistant mutants: despite several attempts to generate mutants on ciprofloxacin containing plates with 2 and 4 µg/ml were unsuccessful, the antibiotic concentration was reduced down to 0.1 and 0.25 µg/ml. Most colonies were detected at a ciprofloxacin concentration of 0.1 µg/ml, and very few colonies (4-5 colonies per 10 plates) were detected on plates containing 0.25 µg/ml of this antibiotic. On plates supplemented with 0.1 µg/ml ciprofloxacin plates, as much as 10-20 colonies could be detected per plate.

Trimethoprim and ciprofloxacin resistant double mutants: The generation of double mutants was carried out by plating same trimethoprim resistant mutants on ciprofloxacin containing (0.1 and 0.25 µg/ml ciprofloxacin), see method section 3.1.2 for generation of double mutants. Most mutants were detected on plates amended with 0.1 µg/ml of ciprofloxacin (approximately 10-20 colonies per plate), however, approximately 4-5 colonies per 10 agar plates were detected in 0.25 µg/ml ciprofloxacin.

The process of colony isolation: approximately ten mutants from each strain were isolated after single colony streaks on antibiotic containing plates. The resistant isolates were frozen down as a LB-glycerol freeze stock (for more details: see section 2.3.2).

Table 5: Numbers of spontaneous single and double mutants isolated for each *E. coli* wild type strain.

Strain	Number of TP mutants	Number of CIP mutants	Number of TP+CIP mutants
K56-22	11	10	6
K56-41	10	10	7
K56-78	10	14	4
Sum	31	34	17

TP – trimethoprim resistant; CIP – ciprofloxacin resistant

In total, 82 mutant isolates were frozen down (Table 5). Every now and then, bright, yellow colonies could be observed among mutant colonies that were streaked on antibiotic containing agar plates after an incubation of 24-36 hours from the initial plates. Although possible sources for contaminations eliminated as good as possible (sterilization of LB agar, horizontal air flow under pouring process (LB agar plates)), the yellow colonies were detected to be contaminations and not *E. coli* mutants according to a PCR analysis (see Figure 10). The yellow colonies were mostly observed when generating mutants on ciprofloxacin containing plates, but no when generating mutants on trimethoprim containing plates. They were only detected on the initial plating of the overnight culture (ONC) on ciprofloxacin containing plates. Some yellow colonies could also be detected when generating double mutants, yet again, the double mutants were generated on ciprofloxacin plates. The exact source of contaminations is unknown. To that end, one possibility could be the large area of agar plates exposed to air when streaking and drying the ONC on the initial, antibiotic containing plates. Another possibility would be a fault

RESULTS

in filter sterilization during the making of antibiotic stock solution of ciprofloxacin. Due to growth of yellow colonies on ciprofloxacin containing plates may most likely mean that the yellow colonies are resistant too.

4.1.1 Confirmation of single and double mutants using paper strip method

Mutant isolates selected for further confirmation were picked using a sterile paper strip and streaked fresh antibiotic containing plates as described earlier in section 3.2.1. Figure 8 shows an example of several mutant isolates in one plate (divided into sections), including one section of no growth (negative control strain: ciprofloxacin susceptible ancestor). This proofed, that the colonies that were picked for further streaking were resistant against the concentration of antibiotic that was present in the plate, which was 0.1 $\mu\text{g/ml}$ of ciprofloxacin in this case. Mutants that were selected for further characterization were either streaked on the same antibiotic concentration that they were originally obtained from or on an antibiotic concentration that was approximately two-fold lower in concentration. This reduced the chance to inhibit growth of the mutant cells. All mutant isolates (82 in total) that were chosen for further characterizations were treated like this.

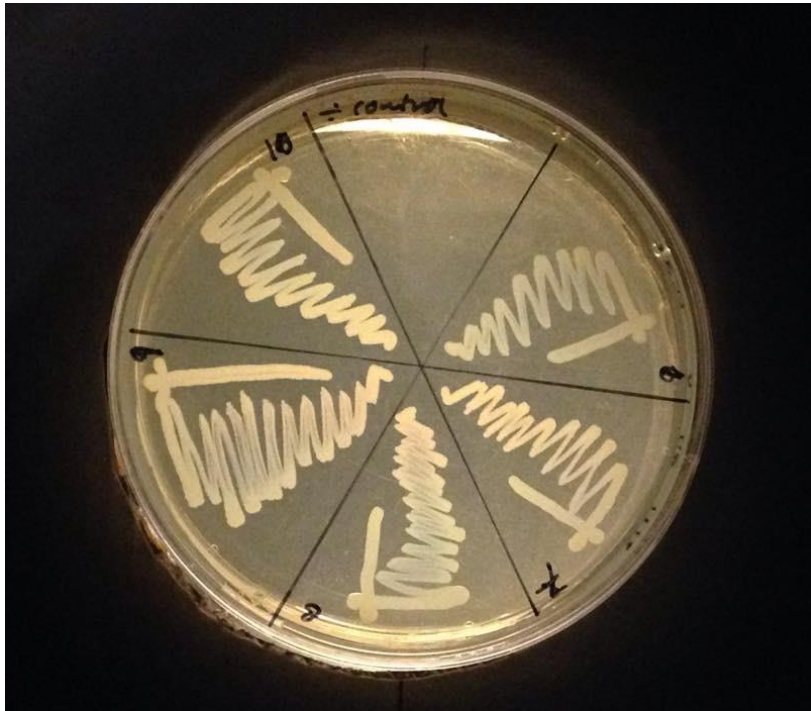

Figure 8: Figure showing an example of five CIP mutant colonies (generated from K56-22) that were streaked in sections on a LB agar plate containing 0.1 $\mu\text{g/ml}$ ciprofloxacin together with a wild type *E. coli* as a negative control.

4.2 Characterization and confirmation of *E. coli* mutants using RAPD1-PCR

RAPD1-PCR was the chosen method to confirm if the mutants belonged to *E. coli* species. Some of the mutants did not show any fingerprints on the gel image, possibly due to faulty preparations of PCR reactions. However, a total of nine mutants (three isolates from each mutational background (TP, CIP and TP+CIP) were selected to measure the growth rate (See Appendix 1: mutant marked with colours).

Isolated mutants were characterized using the RAPD1 thermocycling program. Figure 9 shows an example of gel images of PCR products using RAPD1-PCR to screen all eighty-two mutants collected individually from each strain resistant to either TP or CIP and TP+CIP. Most RAPD fingerprinting analysis contained 10 PCR samples in one gel electrophoresis experiment. The PCR samples of *E. coli* mutants were compared to the respective ancestor *E. coli* strain (positive control) (See section 3.3.2 for PCR controls). The typical band pattern obtained through gel electrophoresis differed between 2 and 4 bands. Bands observed at 600 and 800 base pair (bp) were characteristic for *E. coli*, also according to the positive control.

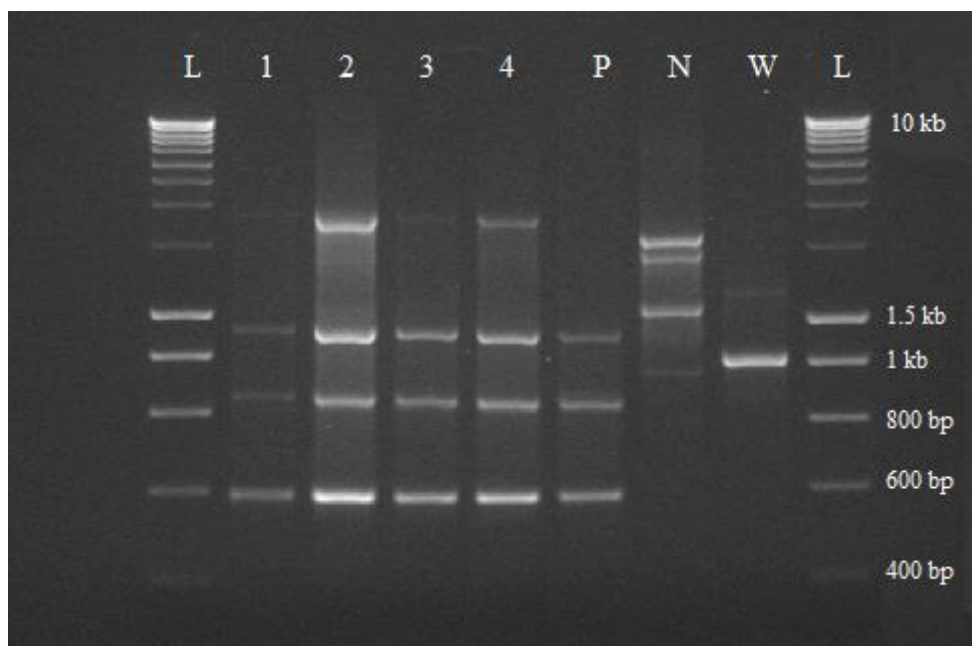

Figure 9: Gel picture of RAPD1-PCR products observed on a 2% agarose gel showing four CIP mutants from strain K56-78. L: molecular marker (SmartLadder) (See Appendix 5: molecular marker). 1-4: *E. coli* mutants (strain K56-78). P: ancestral control, *E. coli* strain. N: Negative control *Acinetobacter baylyi*. W: ddH₂O control.

RESULTS

As mentioned in section 4.1, contaminations could as well be detected when using the RAPD1-PCR analysis. The band pattern of a contamination could obviously not be comparable to the positive control (see Figure 10). *A. baylyi* was used as a negative control, resulting in a visible difference in bands distribution after RAPD1-PCR analysis.

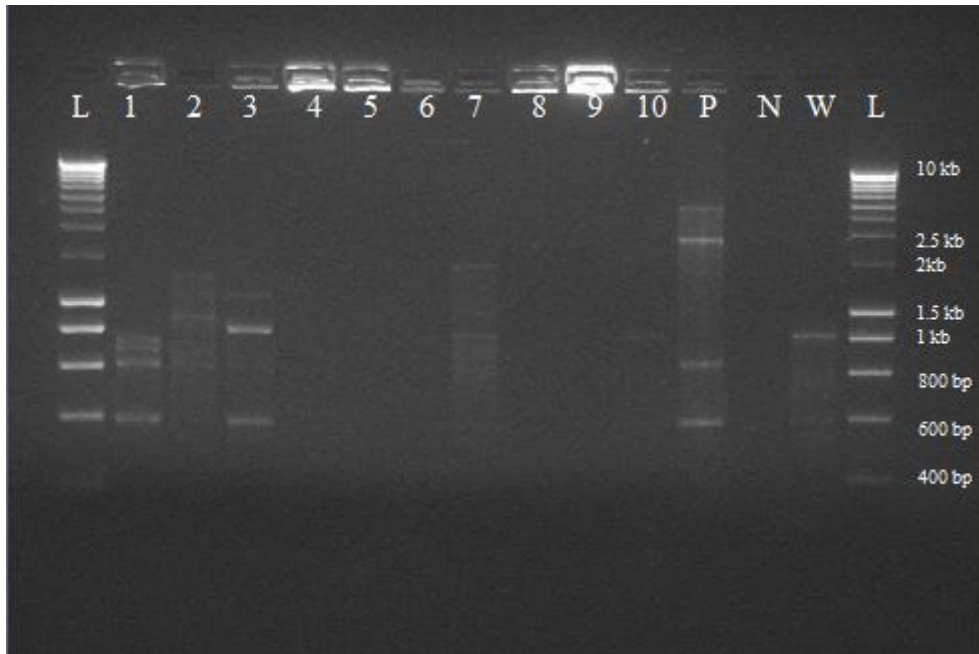

Figure 10: Image of ten PCR samples (CIP mutants of *E. coli* K56-22). L: SmartLadder, Lanes 1-10: *E. coli* mutants, P: ancestral control, *E. coli* strain N: Negative control *A. baylyi*. W: ddH₂O control. Lane 2 and 3 could be contaminations due to differences in band pattern.

Bands showing in water controls: it was not supposed to have any bands showing in the water control, however, the bands that occurred in the water control (at 1 kb, see W – water control see Figure 8) was due to the non-amplified DNA products from the M13 primer added in the PCR reaction without the DNA template. Grisham and his team can explain the bands that were showing in the water control where they wrote in their article saying: “...in RAPD-PCR literature is the existence of primer-derived, nonspecific amplification products in negative control reactions containing all the reaction components except for a DNA template.” And further they said: “These artifacts presumably are absent if a genomic DNA template is included in the reaction.” (Grisham et al., 1997).

4.3 Determination of Minimal Inhibitory Concentration using E-test

The minimal inhibitory concentration (MIC) of TP, CIP and TP+CIP mutants was determined using E-test as described in section 3.5. All MICs presented in the tables below were rounded up according to the twofold dilution using the E-test principle as described in the method section (see Figure 6 in section 3.5.1) and this is also described in the European Committee on Antimicrobial Susceptibility Testing (EUCAST). Raw data of the mutants' MICs (not rounded) (Appendix 1: all mutants collected in this study). According to MIC and EUCAST (clinical breakpoints), it is possible to group the isolates into susceptible/intermediate or resistant mutants of *E. coli*. Initially, the wild type strains were all susceptible. Exposure to antibiotic concentrations around MIC or higher eventually led to reduced susceptibility due to spontaneous mutations. All mutants that are presented in this thesis are most likely single step mutants with reduced susceptibility to trimethoprim and ciprofloxacin.

4.3.1 Classification of resistance levels in bacteria

To be able to compare how susceptibility of wild type *E. coli* strains would change after exposure to antibiotics, E-test was used as a method to determine MIC values of wild type and mutant strains, respectively. The clinical breakpoints of trimethoprim and ciprofloxacin presented in Table 6 indicate at which MIC of the chosen antibiotic the resistance occurred.

Table 6: Clinical breakpoints adopted from EUCAST (V. 5.0, valid from 2015-01-01)

Antimicrobial agent	Susceptible \leq $\mu\text{g/ml}$	Intermediate $\mu\text{g/ml}$	Resistant \geq $\mu\text{g/ml}$
Trimethoprim	2	2 - 4	4
Ciprofloxacin	0.5	0.5 - 1	1

4.3.2 MICs determined for wild type strains

Table 7 show an overview of all three *E. coli* wild type strains and their determined MICs for trimethoprim and ciprofloxacin. For trimethoprim, a clear variation in the wild type MICs could be observed, with concentration ranging from 0.25 to 1 µg/ml, while the MICs from ciprofloxacin E-tests were quite consistent at a concentration of 0.016 µg/ml for all wild type strains. When comparing the *E. coli* wild type MICs to the EUCAST clinical breakpoints, all our strains were characterized as susceptible, as originally reported (Kahlmeter, 2000)

Table 7: Minimal inhibitory concentrations of *E. coli* wild type strains

WT Strains	Trimethoprim (µg/ml)	Ciprofloxacin (µg/ml)	R/IM/S
K56-22	0.25	0.016	S
K56-41	0.5	0.016	S
K56-78	1	0.016	S

WT – wild type; R - resistant; IM – intermediate; S – susceptible

4.3.3 MICs determined for single and double mutants

Single mutants:

MICs were determined for mutant strains as mentioned above. TP22 and TP78 mutants had MICs beyond a concentration of 32 µg/ml, which displayed increased in MICs by 128 (for TP22) and 32 (TP78) folds compared to the MICs of the wild type strains. TP41 had a MIC of 6 µg/ml, which results in a 12 times increased concentration (see Table 8) compared to its wild type strain. When determining MICs for TP22 and TP78, the plate (with a MIC above 32 µg/ml) was covered with bacterial growth on the plate and no inhibition zone could be detected, as for TP41 a bigger inhibition zone was observed. The TP mutants are classified as resistant because of a MIC value above 4 µg/ml (see Table 6).

For the CIP mutants, MICs of 0.5 µg/ml were determined for ciprofloxacin (see Table 9). When comparing with the wild type MICs for ciprofloxacin (0.016 µg/ml), clear increase in the MICs by over 30 times can be observed. According to EUCAST clinical breakpoints, all CIP mutants can thus be classified as intermediate.

Table 8: trimethoprim mutants and their MIC for trimethoprim

Strain	Trimethoprim (µg/ml)	R/IM/S
TP22	> 32	R
TP41	6	R
TP78	>32	R

TP – trimethoprim resistant; R - resistant; IM – intermediate; S – susceptible

Table 9: CIP mutants and their MIC for ciprofloxacin

Strain	Ciprofloxacin (µg/ml)	R/IM/S
CIP22	0.5	IM
CIP41	0.5	IM
CIP78	0.5	IM

CIP – ciprofloxacin resistant; R - resistant; IM – intermediate; S – susceptible

Double mutants:

MICs for the double mutants were determined by co-workers involved in a collaborating project: MIC were determined based on E-test carried out on Muller Hinton agar II-plates with a 0.5 McFarland bacterial suspension and an incubation time of approximately 16 hours at 37 °C. The MICs for trimethoprim were determined to be 0.5, 1 and 8 µg/ml in the double mutants, resulting in a variation in the MICs. Only TP+CIP78 can be classified as resistant with a trimethoprim concentration at 8 µg/ml, while the other TP+CIP (22 and 41) can be classified as ‘susceptible’ due to concentrations of 0.5 and 1 µg/ml in trimethoprim, resulting in TP+CIP being the most susceptible ones to trimethoprim. While the MICs for ciprofloxacin were more consistent, resulting in a concentration of 0.5 µg/ml for all three double mutants. As for the ciprofloxacin, all TP+CIP mutants were classified as ‘intermediate’ to ciprofloxacin (MIC values are presented in Table 10).

RESULTS

Table 10: Table of TP+CIP double mutants and their MICs for each antibiotic.

Strain	Trimethoprim (µg/ml)	R/IM/S	Ciprofloxacin (µg/ml)	R/IM/S
TP+CIP 22	0.5	S	0.5	IM
TP+CIP 41	1	S	0.5	IM
TP+CIP 78	8	R	0.5	IM

TP – trimethoprim resistant; CIP – ciprofloxacin resistant; R - resistant; IM – intermediate; S – susceptible

4.3.4 MICs determined for TP mutants using Ciprofloxacin E-tests

Before generating double mutants, MICs of the TP mutants for ciprofloxacin were determined using E-test strips (see Table 11 for MICs). The MIC of ciprofloxacin in TP mutants was expected to be the same as for the MIC determined in wild type strains. However, the MICs of TP22 and 78 being 0.125 and 0.031 µg/ml for ciprofloxacin had increased compared to wild type strains (22 and 78) with their MICs being 0.016 µg/ml (see Table 7 for MIC of *E. coli* wild type strains). TP41 showed the same MIC as WT41. All TP mutants can be classified as ‘susceptible’ to ciprofloxacin according to EUCAST clinical breakpoints. A possible “cross-resistant” seem to had occurred in two of the TP mutants towards ciprofloxacin.

Table 11: MIC value for ciprofloxacin determined in TP mutants that were chosen for generating double resistant mutants.

Strain	Ciprofloxacin (µg/ml)	R/IM/S
TP22	0.125	S
TP41	0.016	S
TP78	0.031	S

TP – trimethoprim resistant; R - resistant; IM – intermediate; S – susceptible

4.4 Growth curve and generation time

Nine mutant isolates, one from each strain for every resistant combination (TP, CIP and TP+CIP) were chosen based on the MICs and RAPD1-PCR confirmations. Growth curve measurements were conducted using the VersaMax™ Microtiter plate reader and the software SoftMax Pro. The growth started approximately after 1 hour and 20 minutes, according to the raw data sheet for all plate readings in this study. The lag phase, which occurred before 1 hour and 20 minutes is not displayed in any of the growth curve graph due to negative values (negative measurements for Optical Density (OD) were not detected). In this study, six plate readings were conducted, but only two of them are displayed in this section as examples. Figure 11 for example shows that trimethoprim mutant, TP22, was the only strain in this study that had much slower growth compared to the other *E. coli* wild type or mutant strains. The other growth curves of CIP and TP+CIP showed that the growth of the mutant and wild type strain was similar to each other, as shown in Figure 12.

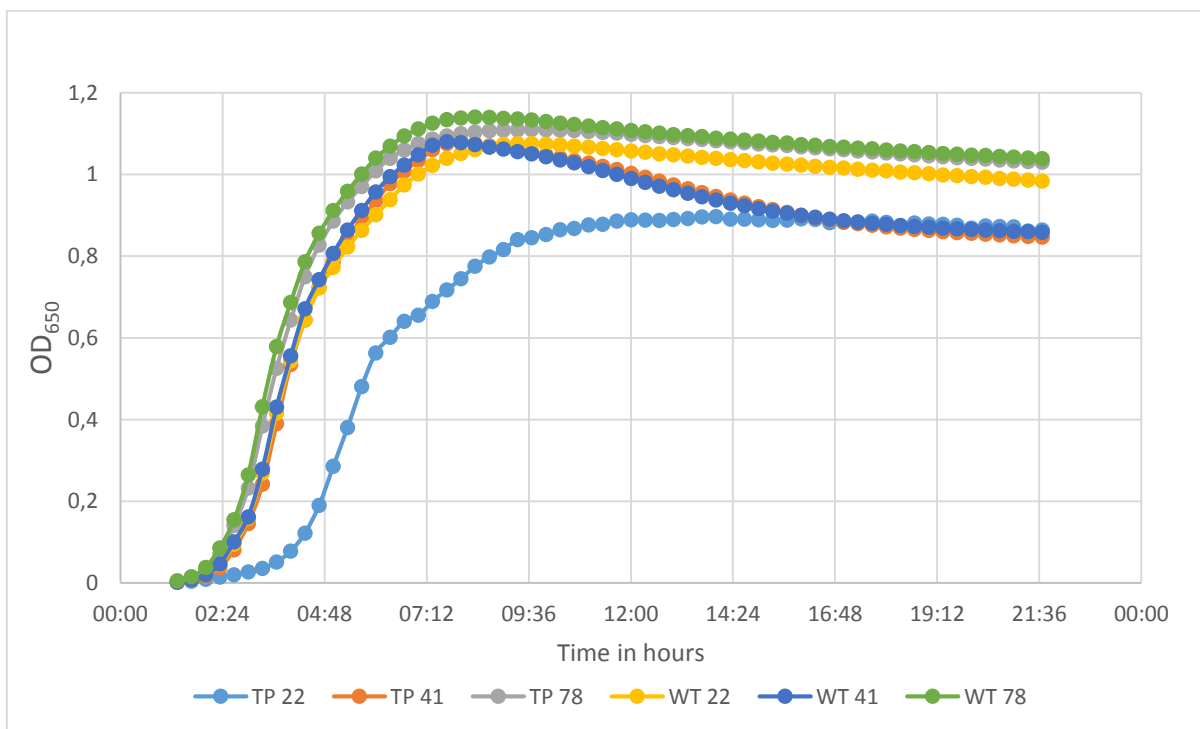

Figure 11: Graph illustrating the growth curve of TP mutants and respective WT strains. There is a significant difference between the slow growth of TP22 and the other strains tested on this plate.

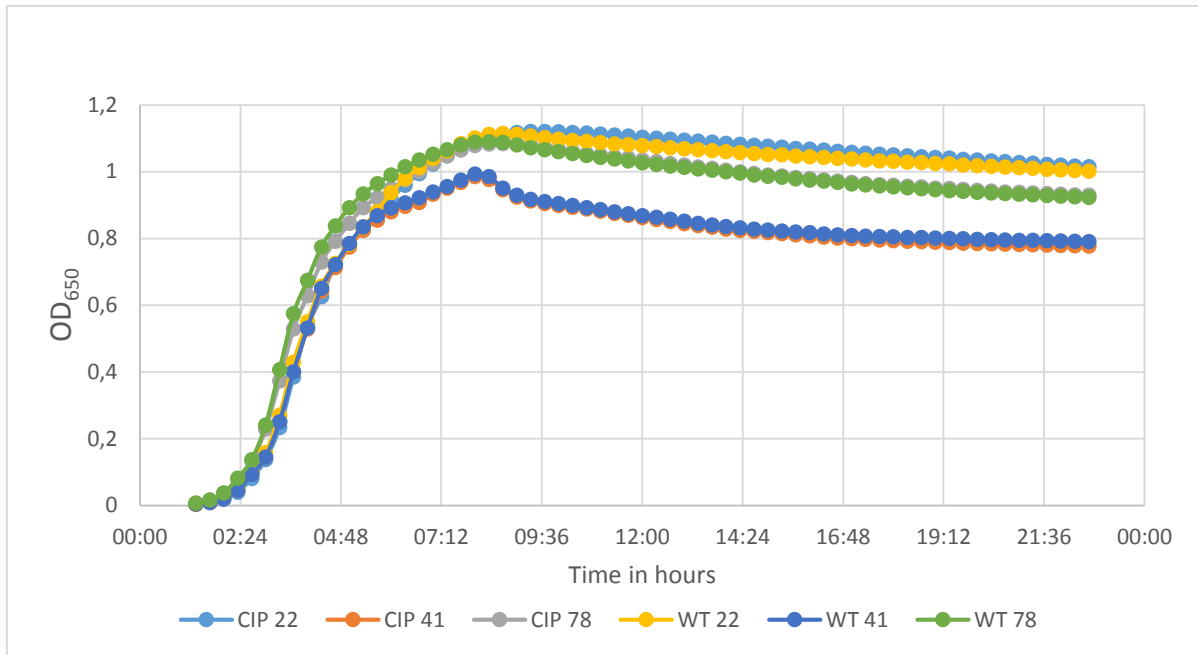

Figure 12: Growth curve of CIP mutants and respective WT strains. It seems that mutant CIP41 and its respective WT41 strain are similar in growth rates with a slightly longer generation time compared to the other strains displayed here.

4.4.1 Calculation of generation time using growth curve measurements

The generation time of the mutant and wild type strains was calculated from growth curve measurements using a semi logarithmic plot to determine the endpoint-value of the slope. However, no semi logarithmic plot was used to determine the starting point of the slope. This is because the lag phase of the growth curve was being concealed during the logarithmic scaling. At least three values were manually chosen to determine the slope for each mutant and wild type strain. The generation time was calculated using Microsoft Excel 2013. The generation time is calculated for all biological replicates for each mutant and wild type strain (N=4) and each biological replicate is an average of 4 parallel readings for each mutant and wild type strain. The calculated generation times are displayed in the tables below:

Table 12: Generation time (in minutes) for TP mutants and WT strains, respectively.

N	TP22	TP41	TP78	WT22	WT41	WT78
1	40	29	28	29	24	27
2	38	28	28	29	30	27
3	38	29	31	29	28	31
4	37	31	30	29	31	29
Mean	38	29	29	29	28	29

TP – trimethoprim resistant; WT – wild type

Table 13: Generation time (in minutes) for CIP mutants and WT mutants, respectively.

N	CIP22	CIP41	CIP78	WT22	WT41	WT78
1	28	27	27	27	29	30
2	27	27	27	28	32	29
3	32	28	31	29	33	28
4	32	33	31	30	30	30
Mean	30	29	29	29	31	29

CIP – ciprofloxacin resistant; WT – wild type

Table 14: Generation time (in minutes) for TP+CIP mutants and WT mutants, respectively.

N	TP+CIP22	TP+CIP41	TP+CIP78	WT22	WT41	WT78
1	33	28	31	30	30	28
2	30	30	31	30	31	28
3	30	27	29	27	23	28
4	29	29	30	28	28	28
Mean	31	29	30	29	28	28

TP – Trimethoprim resistant; CIP – Ciprofloxacin resistant; WT – wild type

4.5 Relative generation time as a measure of fitness

The fitness cost of carrying a resistant mutation was investigated by comparing the growth rates of the spontaneous antibiotic mutant isolates and the respective wild type strains. Relative generation times were calculated and are considered a measurement for fitness in this study. The relative generation time is calculated using equation (4) referred in section 3.8. Figure 13 is a graphical representation of the relative generation time of the three combinations of TP, CIP and TP+CIP mutants with their respective wild type strain.

The relative generation time for WT22/TP22 was found to be 0.76 (± 0.028 confidence interval, $n=4$), which can be translated into an average of 24% more rapid growth of WT22 compared to TP22, meaning that there is a significant difference in the generation time between these two (p -value = $6.33 \cdot 10^{-06}$ (0.00000633), $p \leq 0.05$). As for the other TP mutant strains (41 and 78), the relative generation times resulted in a difference of 3%, (0.966 and 0.974 respectively) faster growth in the WT strains (41 and 78) as compared to the mutant strains only, and no significant differences were detected (p -value = 0.57 and 0.56). This could also be observed by in the average generation time for TP78 and WT78, where both strains had an average generation time of 29 minutes (see Table 12).

The relative generation times determined for CIP mutants showed almost no difference when compared to the generation times of the respective WT strains. CIP22 was the only strain that had a slower growth compared to its WT22 strain. On average, WT22 and CIP22 has a 4% difference in generation time (0.958 ± 0.055 confidence interval), resulting in faster growth for the wild type strain. For mutants CIP41 and CIP78, a relative generation time above one was calculated (1.078 and 1.009 respectively) meaning that the CIP41 and 78 had 7.8% and 0.9% longer generation time compared to the respective WT strains. However, no significant differences were detected (p -value ≥ 0.05) and all relative values could be defined as equal to one (relative values = 1 meaning no difference in the generation time).

Calculation of relative generation times for the double mutants (TP+CIP) resulted in values of 0.94 and 0.98 (relative value = 1) for TP+CIP22 and 41 meaning there is an average of 6% and 2% of faster growth in the respective WT strains (22 and 41). No significant differences were detected with a *p*-value of 0.18 for TP+CIP22 and a *p*-value of 0.80 for TP+CIP41. As for the TP+CIP78 in contrast, there was a significant difference detected with a *p*-value of 0.0033 (*p*-value ≤ 0.05) and a relative generation time of 0.93, translated into an average difference in generation time of 7% (± 0.03 confidence interval) and faster growth in the WT78 strain compared to TP+CIP78 strain.

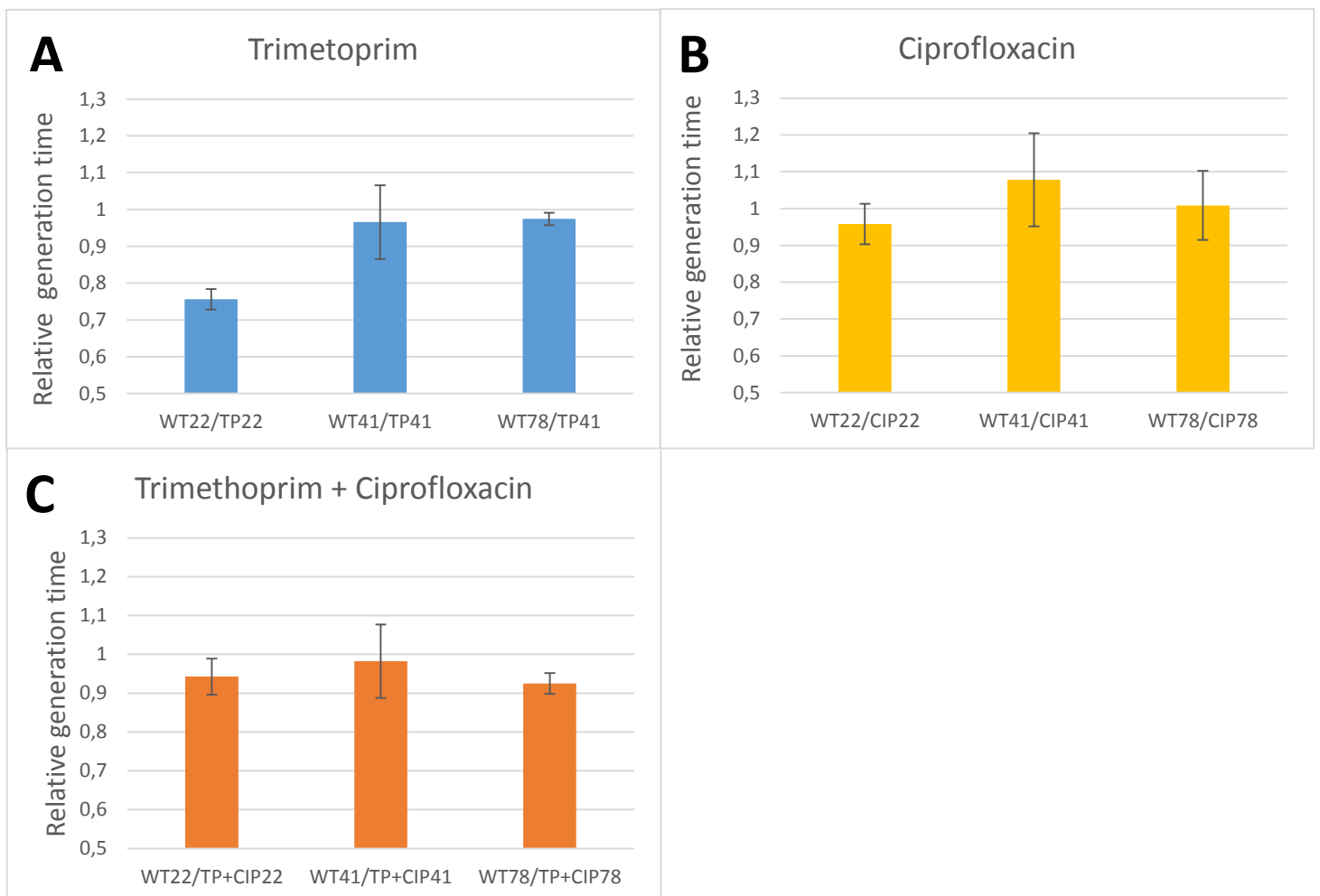

Figure 13: Fitness measurements using relative generation time values for the three mutant/WT combinations; TP mutants/WT (A), CIP mutants/WT (B) and the double mutants TP+CIP/WT (C); relative generation time is represented in bars with colors representing each mutant/WT combination.

5 DISCUSSION

Trindade et al. showed in 2009, that different types of epistasis exist (both, positive and negative) in *E. coli* mutants containing antibiotic resistance mutations (Trindade et al., 2009). The key findings in this thesis are that potential positive epistatic interactions seem to occur by chance in the double mutant TP+CIP22 using relative generation time as a measure of fitness. The TP+CIP22 double mutant (average generation time of 31 minutes) showed a reduced generation time compared to the single mutant TP22 (average generation time of 38 minutes), which results in an average difference in generation times of 7 minutes. Interestingly, negative epistasis was also observed in all double mutants (TP+CIP) in which the MIC towards trimethoprim had decreased compared to the respective single TP mutants. This change in MIC occurred without changes in growth rates.

One trimethoprim resistant mutant (TP22) displayed a severely increased generation time when compared to WT strains, consistent with multiple reports on initial fitness costs of resistance towards other antimicrobial agents (Nilsson et al., 2003, zur Wiesch et al., 2011, Björkholm et al., 2001). However, acquisition of reduced ciprofloxacin susceptibility together with reduced trimethoprim susceptibility in the double mutant restored the generation time to WT levels. These data strongly suggest a positive epistatic interaction between the mutations on the generation time as a measurement of fitness.

Other TP mutants (TP41 and TP78) showed no significant difference in generation time compared to their respective susceptible wild type strains. Mutations conferring reduced susceptibility to antimicrobials that does not reduce fitness are also reported in the literature (Andersson and Hughes, 2010). One study reported the biological cost of resistance in a fosfomycin resistant *E. coli* using growth rates as proxy for relative fitness and showed no significant difference in growth rates between the resistant strain and the susceptible strain in a fosfomycin free environment (Nilsson et al., 2003). In addition, no significant differences in average generation time were detected between the double mutant TP+CIP (K56-22, 41 and 78) strains and their respective WT strains. All single and double mutants and their respective WT strains, except from single mutant TP22, had similar average generation times of approximately 30 minutes. However, no statistical analysis was performed between the combinations. We also found that there were no significant differences in fitness cost between the acquisition of one (single resistant mutants)-, or two (double resistant mutants) mutations

leading to a trimethoprim and/or ciprofloxacin phenotype. These findings suggest that the presence of different mutations resulting in reduced susceptibility to trimethoprim and/or ciprofloxacin in this study, and that these mutations come with different, but not statistically significant fitness costs.

Fitness cost in CIP mutants showed no significant difference in generation time compared with the respective WT strains. One study reported that single mutants (*par* and *gyr*) of *S. pneumonia* (strain R6) had a reduced fitness cost due to acquisition of first-step (low level) quinolone resistance, while the addition of a second resistance gene mutation (*par* and *gyr*) did not affect the fitness cost and other had no measurable fitness cost (Rozen et al., 2007).

The prolonged generation time of TP22 might be influenced by the genetic background of the *E. coli* strains we used and maybe by the fact that the trimethoprim resistance is costly for that particular *E. coli* strain, even though it did not apply to the other TP mutant strains. Trindade and her team also showed that positive epistatic interaction that had occurred in alleles and led to antibiotic resistance, was dependent on a certain genetic background (Trindade et al., 2009). They also meant that the bacterial evolution would favour the positive epistatic interactions if it occurred, making the bacteria more fit and be able to survive and outcompete other susceptible bacteria.

In a clinical and public health point of view, an antimicrobial treatment using ciprofloxacin against *E. coli* resistant to trimethoprim only, can possibly lead to a positive epistatic interaction rendering the trimethoprim resistant strain more fit, depending on the diverse genetic background in bacteria. Studying epistasis is important for us in order to understand the generation of diversity among bacteria through random gene-gene or mutational interactions leading to a specific phenotype (Mani et al., 2008).

Negative epistasis was also observed in this study. A decrease in MIC was determined for trimethoprim in all TP+CIP double mutant strains (K56-22, 41 and 78) compared to the respective TP single mutants (K56-22, 41 and 78). The MIC value for TP were determined to be 12 to 64 times decreased in the double mutants TP+CIP (MIC value presented in Table 8 and Table 10). These data suggest an epistatic interaction of unknown mechanism where acquisition of a mutation that reduce susceptibility to ciprofloxacin re-sensitizes the bacterium to trimethoprim. This is interesting from a treatment perspective. The result demonstrates negative epistatic interactions can occur at different levels and not only affect relative growth

rates. These preliminary data are very interesting, but need further characterization and verification.

Epistatic interactions between two acquired resistance mutations, TP and CIP, were identified by calculation of generation time and determination of MIC values for mutant and WT strains. Analysis and comparison of epistatic patterns by quantifying epistasis could be determined using mathematical models or/and describing fitness landscapes (Schenk et al., 2013), or like we did, by detection of qualitative changes of bacterial phenotypes in bacteria, reviewed in (Phillips, 2008).

Two of three trimethoprim resistant mutants displayed elevated ciprofloxacin MIC's compared to WT strains. Such "cross-resistance" has caught revived attention recently and was termed "collateral resistance" by (Imamovic and Sommer, 2013) (see Table 7 and Table 11). From a clinical perspective, these data suggest that the temporal order of drug consumption is not random. This means if treated with trimethoprim first, the reduced susceptibility towards ciprofloxacin requires perhaps higher doses of ciprofloxacin. This would initially need evaluation by performing time-kill experimented as seen in ((Imamovic and Sommer, 2013)). This was not part of the hypothesis being test here, but a result worth to be mentioned.

Susceptibility-testing by E-tests was a quick way to determine a strains' susceptibility to either trimethoprim or ciprofloxacin. MICs were read manually by the naked eye making the MIC value differ from time to time. Reading the E-test strips, especially the trimethoprim strips, was challenging due a bacteriostatic effect of this antibiotic. To minimize variations in E-test readings in this study, the procedure was standardized regarding incubation time, culture density and interpretation of inhibition zones.

5.1 Determination of fitness cost using growth rate measurements

In this study, we measured growth rates of mutant and wild type strains to be able to determine the fitness effect of a mutation. This method resulted in very consistent data for generation times. The generation times of the chosen *E. coli* wild type strains differed only in a couple of minutes, which was very good. However, the method cannot be considered ‘optimal’ for my study. For an optimal fitness reading, the methodological gold standard would be a direct head-to-head competition between a wild type and a mutant strain. In this scenario, the growth rates of two or more strains (1:1) directly competing with each other in the same vessel and media are measured (Trindade et al., 2009). When performing direct competition assays, relative fitness can be calculated between the two strains. Growth curve measurements make it harder to see the real fitness cost considering that the less fit bacteria has its own space to grow (spatial factor) and its own medium (nutritional factor). Nilsson and his team had measured the fitness cost in *E. coli* by only using the relative growth rates both in rich LB medium and human urine in the presence and absence of fosfomycin, resulting in different results depending on which media was used (Nilsson et al., 2003). The introduction of different variables like choosing different media (such as LB, urine, saline, blood etc), temperature, and pH-adjustments and so on can be considered in a continuation of this project.

5.2 Possible limitations of using growth rates as fitness measurements

For the calculation of generation times of *E. coli* mutant and wild type strains, the start- and endpoint-measurements of the linear slope in the exponential phase of the growth were chosen manually. This was a time-consuming process and a possible source for bias leading to a fault in the calculation of generation times. This would be easier if readings were taken for example every 10 minutes: that could help us determine the linear slope in the exponential phase much easier since there were more values to choose from. Since *E. coli* had a doubling time of 30 minutes, it was also hard to determine the exact doubling time as readings were set to every 20 minutes (as mentioned above).

5.3 The possible reversal of antimicrobial resistance

From a clinical point of view, it is interesting to know whether the resistance towards trimethoprim and ciprofloxacin would decrease or perhaps reverse in the absence of antimicrobial drugs. However, the reversal of antibiotic resistance is not as easy as it may seem. The chances to reverse antibiotic resistance in bacteria may actually be impossible and the time frame for this event depends on time without antibiotic exposure, bacterial species and antimicrobial agent to which resistance exists (Johnsen et al., 2009). An intervention study showed that a reduction in the consumption of trimethoprim did not result in reduced frequencies of trimethoprim resistance, suggesting a low if any cost of resistance (Sundqvist et al., 2010). Even though the data presented here should be interpreted with caution, our data also points out that trimethoprim resistance can be “cost free” making reversal of resistance difficult. This is consistent with previous reports that suggest that it may take many years to observe a visible change in the frequency of resistance, even if resistance is costly (Levin, 2001, Schrag et al., 1997, Johnsen et al., 2011).

5.4 Characterization of trimethoprim and ciprofloxacin resistance in clinical *E. coli* strains

In this study, we only used RAPD1-PCR to characterize the mutant and wild type strains, which was a simple method. An other possible method for species identification would be to apply 16S rRNA sequencing to the isolated *E. coli* mutants (Kawai et al., 2002). It would be also interesting to see where in the genome the mutations had occurred. Characterization of mutants using PCR to first amplify genes that are responsible for fluoroquinolone resistance traits and further use these PCR products for DNA sequencing, was done in the paper of (Strahilevitz and Hooper, 2005) and would, if more time, have been the next step in this report.

5.5 Concluding remarks

Overall, this study showed that being resistant towards trimethoprim or/and ciprofloxacin (mutant strain) did not result in a significant reduction of fitness compared to a respective wild type strain. A positive epistatic interaction was observed in the TP+CIP22 double mutant manifested as reduced generation times compared to the single mutant, TP22. This positive epistatic interaction probably resulted from influences the CIP-resistant phenotype had on TP-resistant phenotype. Interestingly, negative epistasis was also observed at the MIC level where a large reduction in TP-MIC was seen following acquisition of ciprofloxacin resistance in the double mutants (TP-CP). The incidence of epistatic interactions seems to happen randomly and can thus occur unexpectedly considering the genetic diversity in *E. coli*.

If the findings here were directly included in the treatment of uncomplicated UTI caused by *E. coli* the positive and negative epistatic effect could influence the treatment with trimethoprim and ciprofloxacin. The chance for *E. coli* of being severely susceptible to trimethoprim is higher if it was resistant to both trimethoprim and ciprofloxacin instead of resistant to only trimethoprim, if there was a presence of a negative epistatic interaction. Although, this is an *in vitro* study and the conclusions made here cannot be transferred directly to a clinical setting, further characterizations of mutants needs to be made. An *in vivo* study could be considered in the future.

6 REFERENCES

- ANDERSSON, D. I. 2006. The biological cost of mutational antibiotic resistance: any practical conclusions? *Current opinion in microbiology*, 9, 461-465.
- ANDERSSON, D. I. & HUGHES, D. 2010. Antibiotic resistance and its cost: is it possible to reverse resistance? *Nat Rev Microbiol*, 8, 260-71.
- ANDERSSON, D. I. & LEVIN, B. R. 1999. The biological cost of antibiotic resistance. *Curr Opin Microbiol*, 2, 489-93.
- BENNETT, A. F. & LENSKI, R. E. 1993. Evolutionary adaptation to temperature II. Thermal niches of experimental lines of *Escherichia coli*. *Evolution*, 1-12.
- BJÖRKHOLM, B., SJÖLUND, M., FALK, P. G., BERG, O. G., ENGSTRAND, L. & ANDERSSON, D. I. 2001. Mutation frequency and biological cost of antibiotic resistance in *Helicobacter pylori*. *Proceedings of the National Academy of Sciences*, 98, 14607-14612.
- BROWN-JAQUE, M., CALERO-CACERES, W. & MUNIESA, M. 2015. Transfer of antibiotic-resistance genes via phage-related mobile elements. *Plasmid*, 79C, 1-7.
- BROWN, D. F. & BROWN, L. 1991. Evaluation of the E test, a novel method of quantifying antimicrobial activity. *Journal of Antimicrobial Chemotherapy*, 27, 185-190.
- CHEN, I., CHRISTIE, P. J. & DUBNAU, D. 2005. The ins and outs of DNA transfer in bacteria. *Science*, 310, 1456-1460.
- CITRON, D., OSTOVARI, M., KARLSSON, A. & GOLDSTEIN, E. 1991. Evaluation of the E test for susceptibility testing of anaerobic bacteria. *Journal of Clinical Microbiology*, 29, 2197-2203.
- CLERMONT, O., BONACORSI, S. & BINGEN, E. 2000. Rapid and simple determination of the *Escherichia coli* phylogenetic group. *Appl Environ Microbiol*, 66, 4555-8.
- CORDELL, H. J. 2002. Epistasis: what it means, what it doesn't mean, and statistical methods to detect it in humans. *Hum Mol Genet*, 11, 2463-8.
- DAVIES, J. & DAVIES, D. 2010. Origins and Evolution of Antibiotic Resistance. *Microbiol Mol Biol Rev*, 74, 417-33.
- ENNE, V. I., LIVERMORE, D. M., STEPHENS, P. & HALL, L. M. 2001. Persistence of sulphonamide resistance in *Escherichia coli* in the UK despite national prescribing restriction. *The Lancet*, 357, 1325-1328.
- FLENSBURG, J. & SKÖLD, O. 1987. Massive overproduction of dihydrofolate reductase in bacteria as a response to the use of trimethoprim. *European Journal of Biochemistry*, 162, 473-476.

REFERENCE

- FROST, L. S., LEPLAE, R., SUMMERS, A. O. & TOUSSAINT, A. 2005. Mobile genetic elements: the agents of open source evolution. *Nature Reviews Microbiology*, 3, 722-732.
- FULSUNDAR, S., HARMS, K., FLATEN, G. E., JOHNSEN, P. J., CHOPADE, B. A. & NIELSEN, K. M. 2014. Gene transfer potential of outer membrane vesicles of *Acinetobacter baylyi* and effects of stress on vesiculation. *Applied and environmental microbiology*, 80, 3469-3483.
- GOOSSENS, H., FERECHE, M., VANDER STICHELE, R., ELSEVIERS, M. & GROUP, E. P. 2005. Outpatient antibiotic use in Europe and association with resistance: a cross-national database study. *The Lancet*, 365, 579-587.
- GRIFFITH, F. 1928. The significance of pneumococcal types. *Journal of Hygiene*, 27, 113-159.
- GRISHAM, M., WEI, Q., PAN, Y.-B., BURNER, D. & EHRLICH, K. 1997. Analysis of primer-derived, nonspecific amplification products in RAPD-PCR. *Biotechniques*, 22, 1071-1077.
- HOOOPER, D. C. 1999. Mechanisms of fluoroquinolone resistance. *Drug Resist Updat*, 2, 38-55.
- IMAMOVIC, L. & SOMMER, M. O. 2013. Use of collateral sensitivity networks to design drug cycling protocols that avoid resistance development. *Science translational medicine*, 5, 204ra132-204ra132.
- JAIN, R., RIVERA, M. C. & LAKE, J. A. 1999. Horizontal gene transfer among genomes: the complexity hypothesis. *Proc Natl Acad Sci U S A*, 96, 3801-6.
- JIN, D. J. & GROSS, C. A. 1989. Characterization of the pleiotropic phenotypes of rifampin-resistant *rpoB* mutants of *Escherichia coli*. *Journal of bacteriology*, 171, 5229-5231.
- JOHNSBORG, O., ELDHOLM, V. & HÅVARSTEIN, L. S. 2007. Natural genetic transformation: prevalence, mechanisms and function. *Research in microbiology*, 158, 767-778.
- JOHNSEN, P. J., SIMONSEN, G. S., OLSVIK, Ø., MIDTVEDT, T. & SUNDSFJORD, A. 2002. Stability, persistence, and evolution of plasmid-encoded VanA glycopeptide resistance in enterococci in the absence of antibiotic selection in vitro and in gnotobiotic mice. *Microbial Drug Resistance*, 8, 161-170.
- JOHNSEN, P. J., TOWNSEND, J. P., BOHN, T., SIMONSEN, G. S., SUNDSFJORD, A. & NIELSEN, K. M. 2009. Factors affecting the reversal of antimicrobial-drug resistance. *Lancet Infect Dis*, 9, 357-64.
- JOHNSEN, P. J., TOWNSEND, J. P., BOHN, T., SIMONSEN, G. S., SUNDSFJORD, A. & NIELSEN, K. M. 2011. Retrospective evidence for a biological cost of vancomycin resistance determinants in the absence of glycopeptide selective pressures. *J Antimicrob Chemother*, 66, 608-10.

REFERENCE

- KAHLMETER, G. 2000. The ECO.SENS Project: a prospective, multinational, multicentre epidemiological survey of the prevalence and antimicrobial susceptibility of urinary tract pathogens--interim report. *J Antimicrob Chemother*, 46 Suppl 1, 15-22; discussion 63-5.
- KAHLMETER, G. & POULSEN, H. O. 2012. Antimicrobial susceptibility of Escherichia coli from community-acquired urinary tract infections in Europe: the ECO· SENS study revisited. *International journal of antimicrobial agents*, 39, 45-51.
- KAWAI, M., MATSUTERA, E., KANDA, H., YAMAGUCHI, N., TANI, K. & NASU, M. 2002. 16S ribosomal DNA-based analysis of bacterial diversity in purified water used in pharmaceutical manufacturing processes by PCR and denaturing gradient gel electrophoresis. *Applied and environmental microbiology*, 68, 699-704.
- KHAN, A. I., DINH, D. M., SCHNEIDER, D., LENSKI, R. E. & COOPER, T. F. 2011. Negative epistasis between beneficial mutations in an evolving bacterial population. *Science*, 332, 1193-6.
- KOHANSKI, M. A., DWYER, D. J. & COLLINS, J. J. 2010. How antibiotics kill bacteria: from targets to networks. *Nature Reviews Microbiology*, 8, 423-435.
- KOMP LINDGREN, P., KARLSSON, A. & HUGHES, D. 2003. Mutation rate and evolution of fluoroquinolone resistance in Escherichia coli isolates from patients with urinary tract infections. *Antimicrob Agents Chemother*, 47, 3222-32.
- KOONIN, E. V., MAKAROVA, K. S. & ARAVIND, L. 2001. Horizontal gene transfer in prokaryotes: quantification and classification. *Annu Rev Microbiol*, 55, 709-42.
- LEEKHA, S., TERRELL, C. L. & EDSON, R. S. 2011. General Principles of Antimicrobial Therapy. *Mayo Clin Proc*, 86, 156-67.
- LEVIN, B. R. 2001. Minimizing potential resistance: a population dynamics view. *Clinical infectious diseases*, 33, S161-S169.
- LOW, D. E., KELLNER, J. D. & WRIGHT, G. D. 1999. Superbugs: How they evolve and minimize the cost of resistance. *Current infectious disease reports*, 1, 464-469.
- MANI, R., ONGE, R. P. S., HARTMAN, J. L., GIAEVER, G. & ROTH, F. P. 2008. Defining genetic interaction. *Proceedings of the National Academy of Sciences*, 105, 3461-3466.
- MARTINEZ, J. L. 2014. General principles of antibiotic resistance in bacteria. *Drug Discovery Today: Technologies*, 11, 33-39.
- METZGAR, D. & WILLS, C. 2000. Evidence for the adaptive evolution of mutation rates. *Cell*, 101, 581-584.
- MIMS, C., GOERING, R. V., DOCKRELL, H. M., ZUCKERMAN, M., WAKELIN, D., ROITT, I. M. & CHIODINI, P. L. 2008. Mim's Medical Microbiology. *4th edition*.
- MULLIS, K. B. 1990. The unusual origin of the polymerase chain reaction. *Sci Am*, 262, 56-61, 64-5.

REFERENCE

- NIELSEN, K. M., VAN WEERELT, M. D., BERG, T. N., BONES, A. M., HAGLER, A. N. & VAN ELSAS, J. D. 1997. Natural transformation and availability of transforming DNA to *Acinetobacter calcoaceticus* in soil microcosms. *Appl Environ Microbiol*, 63, 1945-52.
- NILSSON, A. I., BERG, O. G., ASPEVALL, O., KAHLMETER, G. & ANDERSSON, D. I. 2003. Biological costs and mechanisms of fosfomycin resistance in *Escherichia coli*. *Antimicrobial agents and chemotherapy*, 47, 2850-2858.
- NORMARK, B. H. & NORMARK, S. 2002. Evolution and spread of antibiotic resistance. *J Intern Med*, 252, 91-106.
- PANKEY, G. A. & SABATH, L. D. 2004. Clinical relevance of bacteriostatic versus bactericidal mechanisms of action in the treatment of Gram-positive bacterial infections. *Clin Infect Dis*, 38, 864-70.
- PHILLIPS, P. C. 2008. Epistasis—the essential role of gene interactions in the structure and evolution of genetic systems. *Nature Reviews Genetics*, 9, 855-867.
- PODNECKY, N. L., WUTHIEKANUN, V., PEACOCK, S. J. & SCHWEIZER, H. P. 2013. The BpeEF-OprC efflux pump is responsible for widespread trimethoprim resistance in clinical and environmental *Burkholderia pseudomallei* isolates. *Antimicrobial agents and chemotherapy*, 57, 4381-4386.
- POURAHMAD JAKTAJI, R. & MOHITI, E. 2010. Study of Mutations in the DNA gyrase *gyrA* Gene of *Escherichia coli*. *Iran J Pharm Res*, 9, 43-8.
- QUINLIVAN, E. P., MCPARTLIN, J., WEIR, D. G. & SCOTT, J. 2000. Mechanism of the antimicrobial drug trimethoprim revisited. *FASEB J*, 14, 2519-24.
- RANG, H. P., DALE, M. M., RITTER, J. M. & FLOWER, R. J. 2007. *Rang and Dale's Pharmacology, 6th edition*.
- REDFIELD, R. J. 1988. Evolution of bacterial transformation: is sex with dead cells ever better than no sex at all? *Genetics*, 119, 213-221.
- ROZEN, D. E., MCGEE, L., LEVIN, B. R. & KLUGMAN, K. P. 2007. Fitness costs of fluoroquinolone resistance in *Streptococcus pneumoniae*. *Antimicrobial agents and chemotherapy*, 51, 412-416.
- SAMBROOK, J. & RUSSEL, D. W. 2001. Molecular cloning: A Laboratory Manual. *Cold Spring Harbor Laboratory Press: Cold Spring Harbor, N.Y.*, 3.
- SCHENK, M. F., SZENDRO, I. G., SALVERDA, M. L., KRUG, J. & DE VISSER, J. A. 2013. Patterns of Epistasis between beneficial mutations in an antibiotic resistance gene. *Mol Biol Evol*, 30, 1779-87.
- SCHRAG, S. J., PERROT, V. & LEVIN, B. R. 1997. Adaptation to the fitness costs of antibiotic resistance in *Escherichia coli*. *Proc Biol Sci*, 264, 1287-91.

REFERENCE

- SILVA, R. F., MENDONCA, S. C., CARVALHO, L. M., REIS, A. M., GORDO, I., TRINDADE, S. & DIONISIO, F. 2011. Pervasive sign epistasis between conjugative plasmids and drug-resistance chromosomal mutations. *PLoS Genet*, 7, e1002181.
- SNIEGOWSKI, P. D., GERRISH, P. J. & LENSKI, R. E. 1997. Evolution of high mutation rates in experimental populations of *E. coli*. *Nature*, 387, 703-705.
- STARIKOVA, I., AL-HARONI, M., WERNER, G., ROBERTS, A. P., SØRUM, V., NIELSEN, K. M. & JOHNSEN, P. J. 2013. Fitness costs of various mobile genetic elements in *Enterococcus faecium* and *Enterococcus faecalis*. *Journal of Antimicrobial Chemotherapy*, 68, 2755-2765.
- STARIKOVA, I., HARMS, K., HAUGEN, P., LUNDE, T. T., PRIMICERIO, R., SAMUELSEN, Ø., NIELSEN, K. M. & JOHNSEN, P. J. 2012. A trade-off between the fitness cost of functional integrases and long-term stability of integrons. *PLoS pathogens*, 8, e1003043.
- STRAHILEVITZ, J. & HOOPER, D. C. 2005. Dual targeting of topoisomerase IV and gyrase to reduce mutant selection: direct testing of the paradigm by using WCK-1734, a new fluoroquinolone, and ciprofloxacin. *Antimicrobial agents and chemotherapy*, 49, 1949-1956.
- SUNDQVIST, M., GELI, P., ANDERSSON, D. I., SJÖLUND-KARLSSON, M., RUNEHAGEN, A., CARLS, H., ABELSON-STORBY, K., CARLS, O. & KAHLMETER, G. 2010. Little evidence for reversibility of trimethoprim resistance after a drastic reduction in trimethoprim use. *Journal of antimicrobial chemotherapy*, 65, 350-360.
- THOMAS, C. M. & NIELSEN, K. M. 2005. Mechanisms of, and barriers to, horizontal gene transfer between bacteria. *Nature reviews microbiology*, 3, 711-721.
- TRINDADE, S., SOUSA, A., XAVIER, K. B., DIONISIO, F., FERREIRA, M. G. & GORDO, I. 2009. Positive epistasis drives the acquisition of multidrug resistance. *PLoS genetics*, 5, e1000578.
- WILLIAMS, J. G., KUBELIK, A. R., LIVAK, K. J., RAFALSKI, J. A. & TINGEY, S. V. 1990. DNA polymorphisms amplified by arbitrary primers are useful as genetic markers. *Nucleic Acids Res*, 18, 6531-5.
- WRIGHT, G. D. 2010. Q&A: Antibiotic resistance: where does it come from and what can we do about it? *BMC Biol*, 8, 123.
- WRIGHT, G. D. 2013. Q&A: antibiotic resistance: what more do we know and what more can we do? *BMC Biol*, 11, 51.
- YOSHIDA, H., BOGAKI, M., NAKAMURA, M. & NAKAMURA, S. 1990. Quinolone resistance-determining region in the DNA gyrase *gyrA* gene of *Escherichia coli*. *Antimicrob Agents Chemother*, 34, 1271-2.
- ZU, P. & LEBEK, G. 1980. Generation time-prolonging R plasmids: correlation between increases in the generation time of *Escherichia coli* caused by R plasmids and their molecular size. *Plasmid*, 3, 65-69.

REFERENCE

ZUR WIESCH, P. A., KOUYOS, R., ENGELSTÄDTER, J., REGOES, R. R. & BONHOEFFER, S. 2011. Population biological principles of drug-resistance evolution in infectious diseases. *The Lancet infectious diseases*, 11, 236-247.

7 APPENDICES

Appendix 1: Total of nine tables of mutants collected in this study with the raw MIC value, PCR confirmations, steps of growth cycle and at which concentration the mutant was isolated from. Mutants that are marked with colors (blue, red and yellow) are the mutants that were selected for the growth curve measurements.

Table A: TP22 mutants isolated in this study

Trimethoprim, Strain K56-22				
Wild Type MIC: 0,125 µg/ml				
No.	Mutants (AB concentration)	PCR	E-test (MIC µg/ml)	Growth cycle (Steps)
1	1 (16 µg/ml)	✓	>32	4
2	2 (16 µg/ml)	✓	>32	4
3	3 (16 µg/ml)	✓	>32	4
4	4 (16 µg/ml)	X	>32	4
5	5 (16 µg/ml)	✓	>32	4
6	6 (16 µg/ml)	✓	>32	4
7	7 (16 µg/ml)	✓	>32	4
8	8 (16 µg/ml)	✓	>32	4
9	9 (8 µg/ml)	✓	>32	4
10	A (LB)	✓	>32	4
11	1 (LB)	✓	>32	4

Table B: TP41 mutants isolated in this study

Trimethoprim, Strain K56-41				
Wild type MIC: 0,38 µg/ml				
No.	Mutants (AB concentration)	PCR	E-test (MIC µg/ml)	Growth cycle (Steps)
1	1A (16 µg/ml)	X	80% from 4	4
2	2A (16 µg/ml)	X	80% from 1,5	4
3	3A (16 µg/ml)	✓	80% from 2	4
4	4A (16 µg/ml)	✓	80% from 2	4
5	5A (16 µg/ml)	✓	80% from 3	4
6	1B (16 µg/ml)	✓	80% from 2	4
7	2B (16 µg/ml)	✓	80% from 3	4
8	3B (16 µg/ml)	✓	80% from 4	4
9	4B (16 µg/ml)	✓	80% from 6	4
10	5B (16 µg/ml)	✓	80% fra 4	4

APPENDICES

Table C: TP78 mutants isolated in this study

Trimethoprim, Strain K56-78				
Wild type MIC: 0,75 µg/ml				
No.	Mutants (AB concentration)	PCR	E-test (MIC µg/ml)	Growth cycle (Steps)
1	1 (4 µg/ml)	X	>32	4
2	2 (4 µg/ml)	✓	>32	4
3	3 (4 µg/ml)	✓	>32	4
4	4 (4 µg/ml)	✓	>32	4
5	5 (4 µg/ml)	✓	>32	4
6	6 (4 µg/ml)	✓	>32	4
7	7 (4 µg/ml)	✓	>32	4
8	8 (4 µg/ml)	✓	>32	4
9	9 (4 µg/ml)	X	>32	4
10	10 (4 µg/ml)	✓	>32	4

Table D: CIP22 mutants isolated in this study

Ciprofloxacin, Strain K56-22				
Wild type MIC: 0,012 µg/ml				
No.	Mutants (AB concentration)	PCR	E-test (MIC µg/ml)	Growth cycle (Steps)
1	1 (0,1 µg/ml)	-	0,38	4
2	2 (0,1 µg/ml)	✓	0,25 – 0,38	4
3	3 (0,1 µg/ml)	✓	0,25	4
4	4 (0,1 µg/ml)	✓	0,38	4
5	5 (0,1 µg/ml)	✓	0,38	4
6	6 (0,1 µg/ml)	✓	0,38	4
7	7 (0,1 µg/ml)	✓	0,5	4
8	8 (0,1 µg/ml)	✓	0,38	4
9	9 (0,1 µg/ml)	✓	0,38	4
10	10 (0,1 µg/ml)	✓	0,38	4

Table E: CIP41 mutants isolated in this study

Ciprofloxacin, Strain K56-41				
Wild type MIC: 0,016 µg/ml				
No.	Mutants (AB concentration)	PCR	E-test (MIC µg/ml)	Growth cycle (Steps)
1	1 (0,1 µg/ml)	✓	0,38	4
2	2 (0,1 µg/ml)	✓	0,38	4
3	3 (0,1 µg/ml)	✓	0,5	4
4	4 (0,1 µg/ml)	✓	0,38	4
5	5 (0,1 µg/ml)	✓	0,5 – 0,75	4
6	6 (0,1 µg/ml)	✓	0,5 – 0,75	4
7	7 (0,1 µg/ml)	✓	0,5	4
8	8 (0,1 µg/ml)	✓	0,38 – 0,5	4
9	9 (0,1 µg/ml)	✓	0,38 – 0,5	4
10	10 (0,1 µg/ml)	✓	0,38 – 0,5	4

Table F: CIP22 mutants isolated in this study

Ciprofloxacin, K56-78				
Wild type MIC: 0,016 µg/ml				
No.	Mutants (AB concentration)	PCR	E-test (MIC µg/ml)	Growth cycle (Steps)
1	1 (0,1 µg/ml)	✓	0,38	4
2	2 (0,1 µg/ml)	✓	0,38	4
3	3 (0,1 µg/ml)	✓	0,25 – 0,38	4
4	4 (0,1 µg/ml)	✓	-	4
5	5 (0,1 µg/ml)	✓	-	4
6	6 (0,1 µg/ml)	✓	-	4
7	7 (0,1 µg/ml)	✓	-	4
8	8 (0,1 µg/ml)	✓	-	4
9	9 (0,1 µg/ml)	✓	-	4
10	10 (0,1 µg/ml)	✓	-	4
11	1 (0,25 µg/ml)	✓	0,38	4
12	2 (0,25 µg/ml)	✓	0,38 – 0,5	4
13	3 (0,25 µg/ml)	✓	0,38	4
14	4 (0,25 µg/ml)	✓	0,38 – 0,5	4

APPENDICES

Table G: TP+CIP22 mutants isolated in this study

Double mutants: Trimethoprim + Ciprofloxacin, K56-22				
TP K56-22 MIC: 0,008 µg/ml ciprofloxacin				
No.	Mutants (AB concentration)	PCR	E-test (MIC µg/ml)	Growth cycle (Steps)
1	1 (0,25 µg/ml cip)	✓	-	8
2	2 (0,25 µg/ml cip)	✓	TP: 0,5 CIP: 0,5	8
3	3 (0,25 µg/ml cip)	✓	-	8
4	4 (0,25 µg/ml cip)	✓	-	8
5	5 (0,25 µg/ml cip)	✓	-	8
6	6 (0,25 µg/ml cip)	✓	-	8

Table H: TP+CIP41 mutants isolated in this study

Double mutants: Trimethoprim + Ciprofloxacin, K56-41				
TP K56-41 MIC: 80%: 0,012 µg/ml ciprofloxacin				
No.	Mutants (AB concentration)	PCR	E-test (MIC µg/ml)	Growth cycle (Steps)
1	1 (0,1 µg/ml cip)	✓	-	8
2	2 (0,1 µg/ml cip)	✓	-	8
3	3 (0,1 µg/ml cip)	✓	-	8
4	4 (0,1 µg/ml cip)	✓	-	8
5	5 (0,1 µg/ml cip)	✓	-	8
6	6 (0,1 µg/ml cip)	✓	-	8
7	7 (0,1 µg/ml cip)	✓	TP: 0,75 CIP: 0,38	8

Table I: TP+CIP78 mutants isolated in this study

Double mutants: Trimethoprim + Ciprofloxacin, K56-78				
TP K56-78 MIC: 0,016 µg/ml ciprofloxacin				
No.	Mutants (AB concentration)	PCR	E-test (MIC µg/ml)	Growth cycle (Steps)
1	1 (0,25 µg/ml)	✓	-	8
2	2 (0,25 µg/ml)	✓	-	8
3	3 (0,25 µg/ml)	✓	TP: 8 CIP: 0,38	8
4	4 (0,25 µg/ml)	✓	-	8

Appendix 2: RAPD-fingerprints of single (CIP) and double (TP+CIP) mutants not presented in results.

Figure A: PCR fingerprints of ten random CIP mutant isolates. L: SmartLadder, Lanes 1-10: *E. coli* mutants, P: ancestral control, *E. coli* strain N: Negative control *A. baylyi*. W: ddH₂O control

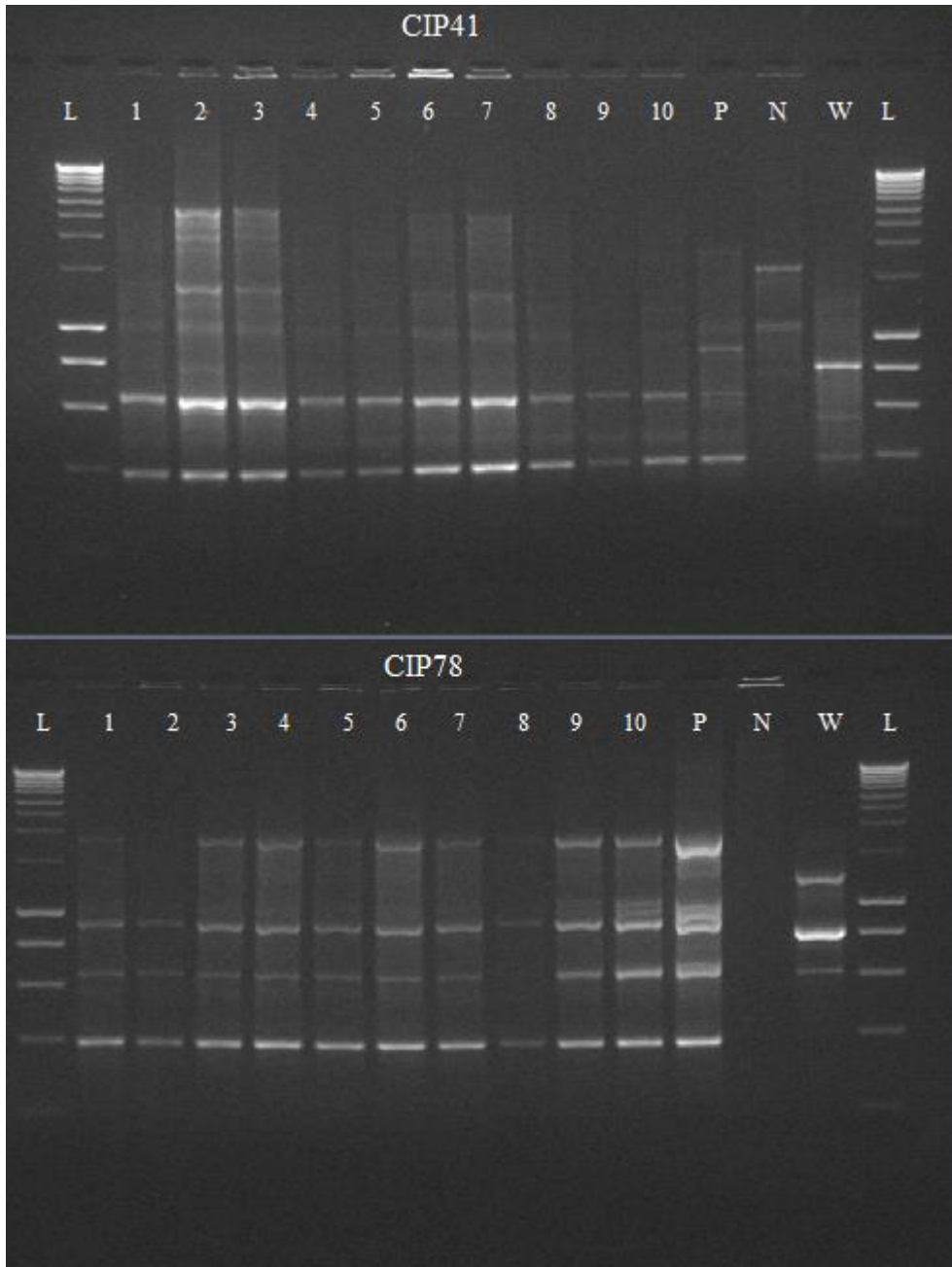
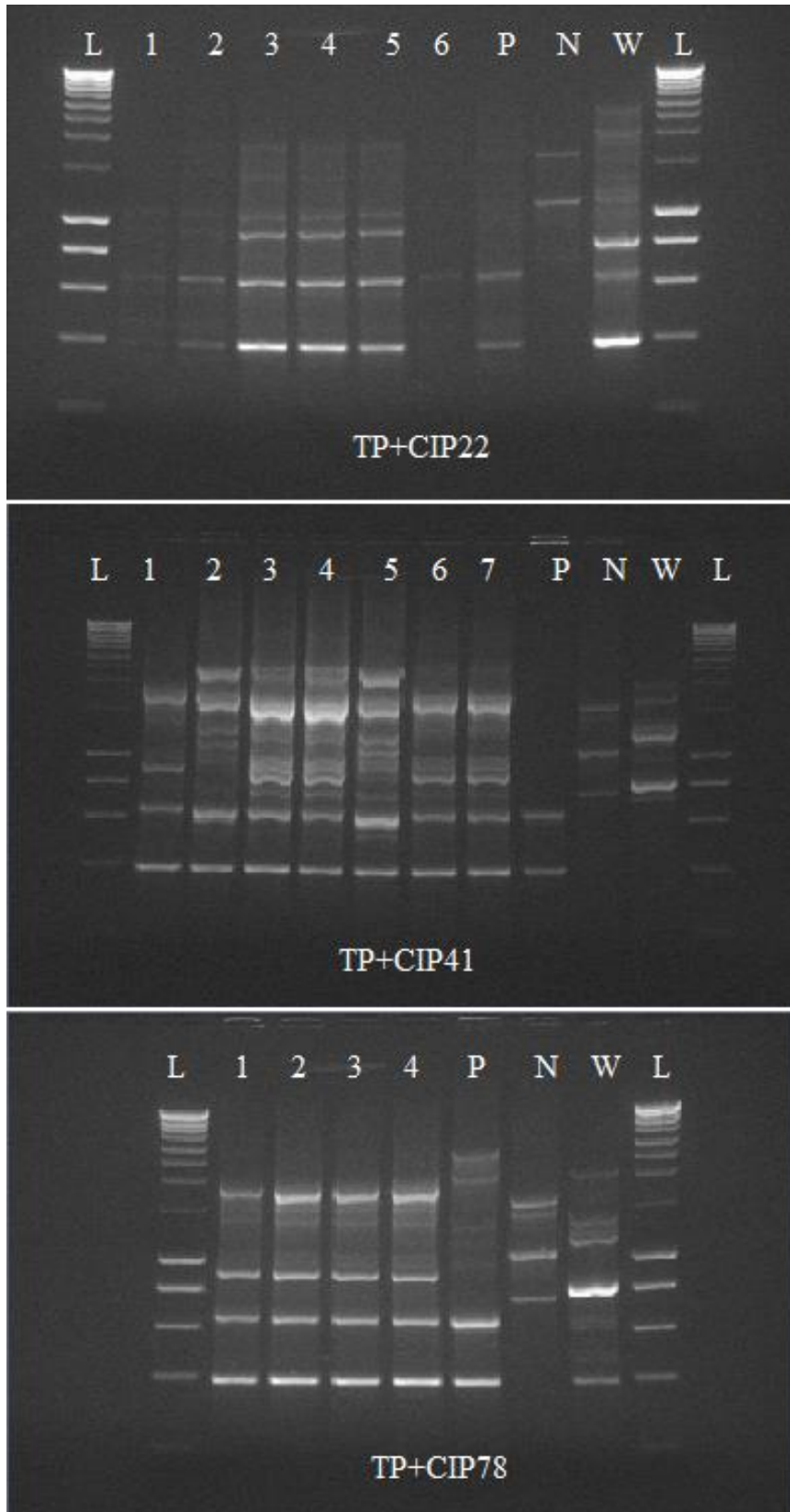

Figure B: PCR fingerprints of double mutant isolates (TP+CIP22, 41 and 78). L: SmartLadder, Lanes 1-6 (TP+CIP22)/1-7(TP+CIP41)/1-4 (TP+CIP78): *E. coli* mutants, P: ancestral control, *E. coli* strain N: Negative control *A. baylyi*. W: ddH₂O control.



APPENDICES

Appendix 3: Growth curve OD650 measurements of single and double mutants with their respective wild type strains. Average raw data was used to calculate generation time for each mutant and wild type strains.

Table J: Average raw data of four biological replicates from OD₆₅₀ growth curve readings of single mutant TP strains with the respective WT strains (technical parallel 1 and 2)

Time	Average TP parallel 1					Time	Average TP parallel 2						
	TP22	TP41	TP 78	WT 22	WT 78		TP 22	TP41	TP 78	WT 22	WT 78		
01:20	0,001533	0,002033	0,0048830,003358	0,002133	0,005183	01:20	0,002933	0,002783	0,005133	0,002783	0,0033830,006308		
01:40	0,004408	0,006583	0,0133330,008983	0,007958	0,015258	01:40	0,006408	0,008283	0,013358	0,008383	0,0098080,016258		
02:00	0,008867	0,016292	0,0315670,020242	0,020267	0,037692	02:00	0,011542	0,019692	0,031567	0,020217	0,0232420,038592		
02:20	0,014333	0,037483	0,0709080,045183	0,046458	0,085958	02:20	0,018383	0,044258	0,070033	0,045358	0,0520580,087108		
02:40	0,019992	0,081242	0,1409920,095117	0,100517	0,154792	02:40	0,025017	0,094917	0,138942	0,096142	0,1111170,156592		
03:00	0,027258	0,145408	0,2325580,158483	0,162108	0,264733	03:00	0,035058	0,157333	0,226758	0,158708	0,1728330,266858		
03:20	0,035967	0,241367	0,3843920,269192	0,278517	0,431042	03:20	0,049717	0,265467	0,376017	0,269392	0,2950670,434617		
03:40	0,051067	0,389842	0,5254670,415617	0,430442	0,578567	03:40	0,073667	0,417492	0,512842	0,414792	0,4450670,580617		
04:00	0,078042	0,534692	0,6433920,543642	0,555942	0,687042	04:00	0,108017	0,546142	0,631892	0,540492	0,5625920,689042		
04:20	0,121967	0,643742	0,7496920,644017	0,671042	0,785942	04:20	0,163317	0,657592	0,738867	0,641992	0,6774670,789217		
04:40	0,190175	0,72365	0,8268250,72205	0,74215	0,8558	04:40	0,248225	0,729325	0,81775	0,722475	0,7501750,86125		
05:00	0,2854	0,7856	0,8858750,772075	0,806575	0,911375	05:00	0,361675	0,794175	0,794175	0,775425	0,8151250,917125		
05:20	0,380017	0,842292	0,9326920,822067	0,863792	0,958817	05:20	0,460792	0,851842	0,927242	0,826667	0,8723420,965867		
05:40	0,480667	0,891192	0,9707170,862917	0,911867	1,000917	05:40	0,549092	0,899767	0,966392	0,869417	0,9209671,009667		
06:00	0,563208	0,935733	1,0090830,901208	0,957183	1,040258	06:00	0,633433	0,944433	1,005783	0,908583	0,9664581,049933		
06:20	0,601367	0,977592	1,0396920,937992	0,994667	1,069167	06:20	0,663742	0,986817	1,040567	0,946692	1,0050171,080742		
06:40	0,640908	1,007783	1,0598830,974283	1,022608	1,093983	06:40	0,693383	1,017983	1,064083	0,985508	1,0348831,106858		
07:00	0,655175	1,0345	1,07555	1,00075	1,048125	1,11475	07:00	0,6963	1,045825	1,08095	1,01375	1,0610751,12525	
07:20	0,688958	1,060433	1,0862831,022333	1,071208	1,125383	07:20	0,734808	1,073458	1,093333	1,036308	1,0845331,139183		
07:40	0,717208	1,075258	1,0944831,039133	1,079958	1,134433	07:40	0,760483	1,091208	1,103733	1,054308	1,0937081,149708		
08:00	0,744625	1,078975	1,0998751,050975	1,078	1,138275	08:00	0,783275	1,09575	1,111325	1,067875	1,0935	1,1553	
08:20	0,775275	1,0753	1,1037	1,06025	1,073125	1,140675	08:20	0,8222	1,09325	1,116025	1,078625	1,09005	1,158
08:40	0,798292	1,070217	1,1067921,067742	1,067142	1,139967	08:40	0,836142	1,089867	1,120042	1,086492	1,085671,157867		
09:00	0,8164	1,065525	1,1086251,0737	1,06195	1,137675	09:00	0,8515	1,0861	1,123025	1,0932	1,08055	1,1571	
09:20	0,840592	1,059092	1,1089671,075392	1,055867	1,135792	09:20	0,873467	1,080017	1,124567	1,095417	1,0736171,155717		
09:40	0,84515	1,054375	1,1096	1,07575	1,0502	1,13315	09:40	0,8822	1,0735	1,1257	1,095625	1,0671751,153025	
10:00	0,852767	1,047592	1,1091921,073992	1,043167	1,129842	10:00	0,892992	1,067142	1,126217	1,094717	1,0608171,150442		
10:20	0,864575	1,04085	1,1086	1,0724	1,0356	1,125775	10:20	0,90825	1,061675	1,12665	1,0942	1,0545251,147775	
10:40	0,86775	1,034	1,1072751,069175	1,028175	1,1227	10:40	0,9118	1,055	1,125575	1,09115	1,04865	1,1435	
11:00	0,876358	1,027308	1,105581,066558	1,019233	1,118508	11:00	0,922758	1,049108	1,124608	1,089883	1,0418331,140483		
11:20	0,877972	1,019642	1,1031421,063417	1,009517	1,114967	11:20	0,928267	1,042592	1,123167	1,087767	1,0340171,137192		
11:40	0,885775	1,011625	1,1012751,060725	1,000175	1,111675	11:40	0,937075	1,0364	1,121825	1,0853	1,0262851,13465		
12:00	0,888717	1,002517	1,0979921,057417	0,989817	1,107542	12:00	0,940942	1,028892	1,119642	1,082667	1,0180421,131167		
12:20	0,888433	0,993283	1,0950831,054208	0,980408	1,104133	12:20	0,942433	1,021283	1,117608	1,079608	1,0111331,128008		
12:40	0,887692	0,983792	1,0925171,050492	0,970892	1,101017	12:40	0,943792	1,013492	1,115367	1,076792	1,0033671,125542		
13:00	0,89005	0,974525	1,0904251,048375	0,96275	1,09775	13:00	0,947025	1,0063	1,1141	1,075525	0,9963	1,120975	
13:20	0,892408	0,965108	1,088081,044508	0,953683	1,095033	13:20	0,950033	0,997808	1,112108	1,072158	0,9892331,120933		
13:40	0,89585	0,955775	1,0853	1,04185	0,94565	1,0924	13:40	0,952425	0,98915	1,109275	1,0697	0,9825751,1179	
14:00	0,896975	0,9463	1,0822251,03915	0,937175	1,0888	14:00	0,953425	0,98155	1,106975	1,066925	0,9753	1,11525	
14:20	0,890342	0,937442	1,0798921,036017	0,929817	1,086242	14:20	0,949342	0,973292	1,104842	1,064667	0,9688921,112917		
14:40	0,890383	0,929783	1,0775081,033758	0,923133	1,084108	14:40	0,950858	0,965733	1,102608	1,062458	0,9626081,110783		
15:00	0,88875	0,92105	1,0749751,030925	0,91635	1,08135	15:00	0,94955	0,95805	1,100125	1,060325	0,9565251,10845		
15:20	0,887108	0,913783	1,0725331,027958	0,910233	1,078808	15:20	0,947883	0,950533	1,098033	1,057708	0,9506831,105933		
15:40	0,888417	0,906967	1,0709671,025342	0,905167	1,076817	15:40	0,950842	0,943417	1,096167	1,055242	0,9455171,103817		
16:00	0,891058	0,899933	1,0677831,022708	0,899658	1,073133	16:00	0,952208	0,936683	1,093758	1,053608	0,9402581,101408		
16:20	0,889408	0,894233	1,0649331,020183	0,895083	1,071733	16:20	0,951283	0,930308	1,091333	1,051583	0,9351581,099858		
16:40	0,881742	0,888542	1,0626921,017642	0,890367	1,068517	16:40	0,946367	0,924267	1,089117	1,049417	0,9306671,097742		
17:00	0,882792	0,883617	1,0604421,015492	0,886542	1,066592	17:00	0,946967	0,919217	1,086667	1,047367	0,9267421,095917		
17:20	0,883075	0,879275	1,0577	1,013	0,8834	1,0643	17:20	0,946175	0,914	1,084325	1,045075	0,9226	1,09335
17:40	0,885483	0,875783	1,0552581,010408	0,880683	1,062833	17:40	0,947633	0,909283	1,081208	1,042683	0,9190831,092058		
18:00	0,882883	0,871633	1,0526831,008433	0,877983	1,060058	18:00	0,945483	0,905208	1,078683	1,041358	0,9156331,089983		
18:20	0,875058	0,868283	1,0502831,005758	0,874833	1,057708	18:20	0,941708	0,901733	1,077108	1,040133	0,9131831,087983		
18:40	0,881042	0,865492	1,0477421,003767	0,872842	1,055842	18:40	0,943817	0,897742	1,074117	1,037342	0,9098171,086192		
19:00	0,8789	0,862775	1,0459251,0018	0,870675	1,053475	19:00	0,94365	0,894875	1,0721	1,035875	0,9070751,0848		
19:20	0,8782	0,86025	1,0433	0,999025	0,8686	1,051225	19:20	0,942625	0,89165	1,069225	1,033725	0,9048751,08245	
19:40	0,875833	0,857858	1,0408080,996883	0,867033	1,049658	19:40	0,941558	0,889033	1,066808	1,032008	0,9027581,081408		
20:00	0,868175	0,855725	1,03975	0,994625	0,86555	1,047325	20:00	0,9373	0,885875	1,06475	1,029875	0,9001751,07885	
20:20	0,8744	0,8537	1,0375	0,992875	0,864075	1,04645	20:20	0,939175	0,88365	1,061875	1,02795	0,8982751,07715	
20:40	0,872583	0,851808	1,0352330,990158	0,862208	1,043858	20:40	0,938783	0,881158	1,059658	1,026433	0,8960831,075158		
21:00	0,871358	0,850108	1,0333580,988158	0,860908	1,042858	21:00	0,936408	0,878658	1,057408	1,024033	0,8940081,074183		
21:20	0,86155	0,848275	1,0314250,985925	0,8599	1,04045	21:20	0,9334	0,87655	1,0554	1,02245	0,8926	1,072425	
21:40	0,863625	0,84695	1,0297250,984025	0,858475	1,038775	21:40	0,933625	0,87505	1,053575	1,020525	0,89085	1,0711	
22:00	0,86705	0,84545	1,027750,9822	0,857575	1,03715	22:00	0,934825	0,87305	1,05145	1,018625	0,889	1,0691	
22:20	0,864408	0,843658	1,0258080,979383	0,856108	1,034483	22:20	0,932958	0,871783	1,050508	1,017958	0,8877581,068058		
22:40	0,858567	0,842592	1,0246670,977542	0,855642	1,033167	22:40	0,930492	0,869517	1,047592	1,015067	0,8866171,065017		
23:00	0,858833	0,841633	1,0234580,976033	0,854808	1,032083	23:00	0,930058	0,868058	1,046158	1,013458	0,8850831,064358		

APPENDICES

Table K: Average raw data of four biological replicates from OD650 growth curve readings of single mutant TP strains with the respective WT strains (technical parallel 3 and 4)

Time	Average TP parallel 3						Average TP parallel 4					
	TP 22	TP 41	TP 78	WT 22	WT 41	WT 78	TP 22	TP 41	TP 78	WT 22	WT 41	WT 78
01:20	0,00445	0,003825	0,0065	0,00555	0,003025	0,005775	0,00275	0,00285	0,0051	0,00495	0,003875	0,006975
01:40	0,007325	0,007925	0,013275	0,0106	0,00645	0,012725	0,004575	0,006075	0,0114	0,009725	0,007475	0,01495
02:00	0,0115	0,017025	0,028675	0,021775	0,0134	0,028875	0,0069	0,013075	0,025325	0,020125	0,0153	0,0329
02:20	0,016975	0,035875	0,0612	0,045575	0,028775	0,06395	0,0104	0,028	0,0551	0,04265	0,0315	0,071925
02:40	0,023	0,07625	0,1272	0,0946	0,060875	0,13275	0,014375	0,059275	0,115075	0,088525	0,0662	0,14415
03:00	0,030758	0,143133	0,200983	0,157033	0,127608	0,208058	0,019008	0,121583	0,181408	0,156858	0,135758	0,227058
03:20	0,0414	0,2259	0,342475	0,266275	0,19055	0,35805	0,024925	0,1853	0,3129	0,253925	0,199125	0,3808
03:40	0,055783	0,368983	0,482058	0,411808	0,323783	0,513708	0,031958	0,311033	0,450208	0,404983	0,334458	0,542408
04:00	0,0826	0,522675	0,6097	0,539825	0,476525	0,630125	0,042775	0,464125	0,5862	0,537025	0,485825	0,64985
04:20	0,12935	0,618725	0,71475	0,64045	0,579275	0,7381	0,06285	0,57275	0,68825	0,626325	0,5861	0,75395
04:40	0,195258	0,709433	0,794058	0,712833	0,685008	0,815958	0,099933	0,682633	0,772883	0,715083	0,693158	0,831458
05:00	0,287533	0,776333	0,854358	0,767258	0,751333	0,874883	0,159158	0,750783	0,837058	0,767208	0,760908	0,889533
05:20	0,389942	0,835467	0,902367	0,817792	0,813917	0,926692	0,240192	0,814717	0,888717	0,818517	0,822417	0,939167
05:40	0,478642	0,885917	0,942367	0,859817	0,865842	0,969992	0,336367	0,868042	0,928767	0,861167	0,874792	0,981992
06:00	0,5451	0,9317	0,9819	0,8986	0,91315	1,011575	0,427975	0,91705	0,96825	0,900775	0,923025	1,022325
06:20	0,603217	0,976017	1,013342	0,935667	0,958667	1,045892	0,538592	0,963167	1,000642	0,936342	0,968242	1,056692
06:40	0,62695	1,008925	1,033775	0,9732	0,992875	1,073325	0,5921	0,99915	1,02285	0,974375	1,003075	1,084225
07:00	0,652017	1,035217	1,050192	1,000817	1,019167	1,095642	0,633617	1,028592	1,040492	1,004217	0,930617	1,105542
07:20	0,678675	1,062925	1,060425	1,021275	1,04625	1,11105	0,64635	1,0535	1,05155	1,02645	1,0584	1,120775
07:40	0,7098	1,080275	1,067725	1,03585	1,065825	1,123225	0,665725	1,078825	1,060125	1,0436	1,0767	1,1333
08:00	0,740342	1,083217	1,073417	1,047817	1,067767	1,129817	0,702217	1,089667	1,065692	1,056292	1,078567	1,140267
08:20	0,7693	1,0791	1,07685	1,0571	1,063375	1,132475	0,735025	1,08825	1,0697	1,0659	1,075325	1,14255
08:40	0,794192	1,074267	1,079767	1,064242	1,058167	1,132792	0,759717	1,084942	1,074117	1,073442	1,070892	1,143992
09:00	0,815192	1,068692	1,081567	1,068142	1,052192	1,131242	0,805542	1,079742	1,076542	1,077817	1,065367	1,143367
09:20	0,829267	1,062492	1,082967	1,070017	1,045917	1,128742	0,831417	1,072117	1,078917	1,079517	1,058642	1,141142
09:40	0,833517	1,055942	1,083792	1,069767	1,039442	1,125642	0,840167	1,064767	1,081067	1,079267	1,051867	1,138242
10:00	0,841108	1,049208	1,083633	1,067958	1,032858	1,122483	0,853583	1,057458	1,081633	1,078083	1,044933	1,136183
10:20	0,853292	1,041867	1,082692	1,065542	1,025967	1,119217	0,868617	1,050167	1,082067	1,076367	1,038217	1,132817
10:40	0,853317	1,035142	1,082092	1,063242	1,018567	1,115417	0,872267	1,044167	1,081067	1,074092	1,031342	1,129367
11:00	0,852808	1,028208	1,080458	1,060633	1,010233	1,111733	0,872683	1,037408	1,080108	1,071683	1,024758	1,125983
11:20	0,860308	1,021108	1,078008	1,057508	1,000458	1,108258	0,881958	1,031208	1,078783	1,069758	1,017483	1,122433
11:40	0,858092	1,014192	1,076767	1,055117	0,990567	1,104842	0,881467	1,024967	1,077767	1,067267	1,009792	1,118467
12:00	0,860475	1,005975	1,074275	1,051625	0,9793	1,10145	0,884275	1,0186	1,076175	1,064575	1,001725	1,1154
12:20	0,864017	0,997717	1,072117	1,048817	0,968692	1,098242	0,887867	1,011942	1,074267	1,061942	0,993867	1,111717
12:40	0,870375	0,989525	1,0697	1,04625	0,957925	1,095175	0,8965	1,00535	1,072675	1,06015	0,985875	1,1093
13:00	0,866425	0,980675	1,06725	1,043325	0,947825	1,092275	0,8904	0,998625	1,070225	1,057325	0,978075	1,10575
13:20	0,876817	0,971517	1,065092	1,040417	0,937842	1,089292	0,900642	0,991992	1,068517	1,055267	0,970742	1,103192
13:40	0,865683	0,963858	1,063108	1,037708	0,928858	1,086383	0,892483	0,985258	1,066483	1,053133	0,963658	1,099783
14:00	0,867183	0,955433	1,061008	1,035433	0,920008	1,083658	0,896333	0,978733	1,064658	1,050758	0,956133	1,097258
14:20	0,869283	0,947683	1,058933	1,032783	0,912208	1,080733	0,900858	0,972108	1,062983	1,048808	0,949733	1,094333
14:40	0,86245	0,93955	1,056825	1,03015	0,90465	1,078325	0,8939	0,965625	1,061025	1,0466	0,943275	1,0914
15:00	0,862217	0,932417	1,054367	1,028167	0,897567	1,075717	0,896867	0,960142	1,059692	1,044892	0,937042	1,089192
15:20	0,861633	0,924583	1,052333	1,025158	0,891108	1,072908	0,895533	0,953683	1,057783	1,042808	0,931208	1,086308
15:40	0,86755	0,9173	1,050425	1,0227	0,885875	1,070225	0,901475	0,947325	1,055575	1,0408	0,925325	1,084575
16:00	0,854775	0,91035	1,048025	1,02065	0,88045	1,067425	0,8891	0,941975	1,0544	1,03925	0,9201	1,0825
16:20	0,859142	0,903842	1,046567	1,018092	0,876042	1,064917	0,895467	0,935942	1,052242	1,036942	0,915142	1,079417
16:40	0,8562	0,897675	1,044475	1,015825	0,872375	1,062525	0,8931	0,930275	1,050725	1,034675	0,9105	1,076975
17:00	0,8487	0,89215	1,042175	1,01355	0,868475	1,059725	0,88525	0,9248	1,048825	1,033125	0,9063	1,074975
17:20	0,858217	0,886067	1,040342	1,011442	0,865492	1,057392	0,894942	0,919692	1,047567	1,031567	0,902642	1,072967
17:40	0,855675	0,88135	1,03925	1,009325	0,8627	1,05535	0,893225	0,91465	1,0455	1,0296	0,8983	1,070425
18:00	0,847183	0,876658	1,036658	1,006933	0,860008	1,052383	0,886433	0,910208	1,044558	1,028708	0,895558	1,069208
18:20	0,841775	0,872525	1,0345	1,004925	0,85765	1,04995	0,882175	0,90575	1,04285	1,026825	0,891925	1,0672
18:40	0,841608	0,868658	1,033058	1,003008	0,856158	1,047958	0,882258	0,901083	1,040858	1,024958	0,888808	1,064558
19:00	0,834075	0,865	1,031	1,0009	0,85375	1,04465	0,874925	0,89695	1,03995	1,0239	0,8861	1,063125
19:20	0,8444	0,862	1,029475	0,998825	0,852625	1,04275	0,883975	0,892825	1,03795	1,022	0,883025	1,060225
19:40	0,8353	0,8591	1,027225	0,99645	0,85065	1,03975	0,8783	0,889575	1,036875	1,02065	0,880625	1,05895
20:00	0,826358	0,856358	1,025158	0,994608	0,848858	1,037258	0,870233	0,886058	1,035408	1,019308	0,878108	1,056533
20:20	0,829692	0,854192	1,023942	0,993217	0,848267	1,035242	0,873417	0,882467	1,034292	1,018042	0,875717	1,054917
20:40	0,82755	0,85185	1,02235	0,991425	0,846875	1,032975	0,8726	0,879625	1,0334	1,0171	0,873625	1,0533
21:00	0,822475	0,849775	1,02	0,9888	0,845225	1,030925	0,8685	0,876675	1,03165	1,0156	0,871525	1,0519
21:20	0,818758	0,847958	1,018283	0,986933	0,844033	1,028708	0,865133	0,874083	1,030758	1,013983	0,869858	1,050283
21:40	0,8131	0,84625	1,01675	0,984575	0,842525	1,026025	0,857425	0,871225	1,029325	1,012525	0,867825	1,048175
22:00	0,816842	0,845017	1,015592	0,982717	0,841692	1,023417	0,863617	0,868742	1,027992	1,011217	0,865592	1,045642
22:20	0,810117	0,843367	1,013842	0,980692	0,840492	1,021217	0,859067	0,866517	1,027092	1,010067	0,863842	1,044367

APPENDICES

Table L: Average raw data of four biological replicates from OD₆₅₀ growth curve readings of single mutant CIP strains with the respective WT strains (technical parallel 1 and 2)

Time	Average CIP parallel 1						Average CIP parallel 2					
	CIP 22	CIP 41	CIP 78	WT 22	WT 41	WT 78	CIP 22	CIP 41	CIP 78	WT 22	WT 41	WT 78
01:20	0,006742	0,005992	0,007742	0,005217	0,004642	0,008367	0,004267	0,003642	0,007267	0,004842	0,003942	0,007092
01:40	0,012875	0,012925	0,01695	0,010675	0,009825	0,01845	0,008975	0,009175	0,016225	0,010875	0,009325	0,01645
02:00	0,025592	0,027467	0,037067	0,022217	0,021192	0,041392	0,018917	0,021042	0,035917	0,023567	0,021092	0,037717
02:20	0,052192	0,058492	0,079642	0,046692	0,045392	0,088867	0,039942	0,045767	0,077842	0,050192	0,045767	0,081692
02:40	0,102508	0,113433	0,134258	0,093358	0,092183	0,144883	0,081583	0,094508	0,133058	0,100033	0,093658	0,137733
03:00	0,162125	0,175	0,23325	0,150675	0,144325	0,256075	0,137875	0,145025	0,229225	0,158525	0,145225	0,241475
03:20	0,27715	0,299925	0,379	0,25845	0,25035	0,42525	0,2341	0,2525	0,37385	0,270875	0,25095	0,40765
03:40	0,438175	0,445325	0,535175	0,4132	0,3997	0,582225	0,38565	0,401825	0,5294	0,429325	0,40065	0,574725
04:00	0,566467	0,559792	0,639492	0,546942	0,530967	0,690742	0,534492	0,529017	0,629017	0,550992	0,531567	0,675242
04:20	0,674208	0,668508	0,734083	0,651258	0,646583	0,778158	0,625558	0,642833	0,729183	0,657808	0,650433	0,774933
04:40	0,739692	0,732617	0,796592	0,719392	0,715992	0,838117	0,723517	0,713417	0,791892	0,725567	0,721692	0,837967
05:00	0,791725	0,789625	0,848625	0,77315	0,7761	0,890575	0,7781	0,774325	0,845125	0,781975	0,784925	0,893025
05:20	0,839975	0,8317	0,891725	0,821675	0,82415	0,924775	0,827525	0,8241	0,892475	0,83475	0,835475	0,933425
05:40	0,882517	0,859092	0,921067	0,867417	0,855517	0,952592	0,874967	0,855267	0,922292	0,881217	0,868792	0,964892
06:00	0,924483	0,881958	0,947158	0,913083	0,877808	0,976333	0,918808	0,879933	0,948783	0,937633	0,891908	0,980458
06:20	0,962483	0,897808	0,971333	0,956633	0,892533	0,997983	0,960158	0,896858	0,975558	0,979108	0,907058	1,015433
06:40	0,9926	0,9103	0,997775	0,98925	0,909975	1,019025	0,99415	0,907675	1,000575	1,012575	0,925975	1,0354
07:00	1,018058	0,933108	1,019808	1,015908	0,924083	1,033383	1,022633	0,932408	1,025808	1,040008	0,939608	1,053133
07:20	1,039075	0,9521	1,039275	1,037	0,941875	1,04435	1,0475	0,951525	1,047625	1,062525	0,9562	1,066375
07:40	1,056158	0,969008	1,056558	1,056933	0,960808	1,058058	1,065958	0,968008	1,066533	1,084758	0,974958	1,080358
08:00	1,072175	0,978825	1,067925	1,070475	0,97525	1,0654	1,0822	0,985175	1,078425	1,102075	0,99295	1,08945
08:20	1,088383	0,946008	1,070108	1,077758	0,944033	1,065683	1,098783	0,977458	1,083658	1,112108	0,985533	1,089783
08:40	1,097525	0,9201	1,068975	1,0832	0,914225	1,060175	1,111625	0,946475	1,08425	1,115325	0,951325	1,08815
09:00	1,102367	0,904267	1,066217	1,085742	0,897342	1,052717	1,117942	0,924342	1,082992	1,112342	0,929567	1,080342
09:20	1,103425	0,8959	1,06165	1,0874	0,888175	1,04515	1,120525	0,91265	1,0808	1,107825	0,917775	1,07225
09:40	1,102733	0,889308	1,055833	1,086283	0,881283	1,038808	1,120408	0,904808	1,073158	1,102658	0,910408	1,065983
10:00	1,100167	0,883192	1,048017	1,085492	0,874692	1,032817	1,119692	0,899517	1,067167	1,098067	0,904592	1,060042
10:20	1,097517	0,875992	1,042017	1,082592	0,867817	1,027117	1,118017	0,893842	1,060667	1,094192	0,898992	1,054642
10:40	1,093267	0,867492	1,036692	1,079617	0,859967	1,019442	1,115667	0,888392	1,054167	1,090767	0,893017	1,049117
11:00	1,090042	0,859892	1,031292	1,076467	0,852617	1,012942	1,112917	0,882042	1,050142	1,087167	0,886892	1,042967
11:20	1,08585	0,852125	1,025625	1,073475	0,84555	1,006575	1,110025	0,875325	1,045275	1,0837	0,880475	1,0381
11:40	1,081383	0,845458	1,019783	1,069708	0,839058	1,000033	1,107108	0,869308	1,041158	1,081658	0,874558	1,032558
12:00	1,076867	0,838617	1,013742	1,065017	0,833117	0,994842	1,103992	0,862917	1,035592	1,078392	0,868667	1,027042
12:20	1,0728	0,8322	1,008075	1,06115	0,827075	0,990025	1,101	0,85725	1,030525	1,075375	0,863425	1,021975
12:40	1,068458	0,824658	1,003083	1,056983	0,820033	0,984408	1,097883	0,851458	1,025408	1,072408	0,857858	1,017233
13:00	1,064383	0,818058	0,997908	1,052883	0,813233	0,979508	1,095158	0,844883	1,020033	1,069208	0,852033	1,013433
13:20	1,060275	0,8119	0,9926	1,0482	0,8073	0,973975	1,091925	0,838825	1,014725	1,066225	0,84595	1,0088
13:40	1,05615	0,8069	0,9883	1,04465	0,8021	0,96925	1,089325	0,8337	1,01015	1,0633	0,840975	1,00525
14:00	1,05215	0,802225	0,98365	1,0406	0,797925	0,964475	1,08585	0,8285	1,0047	1,06015	0,83575	1,000475
14:20	1,048075	0,7988	0,97885	1,036375	0,7943	0,9593	1,0827	0,824875	1,000325	1,05775	0,83195	0,996275
14:40	1,044208	0,795533	0,974758	1,032883	0,791158	0,954733	1,079558	0,821208	0,994958	1,054508	0,828383	0,990783
15:00	1,040367	0,791917	0,970567	1,029617	0,788242	0,950142	1,076367	0,817892	0,990892	1,051942	0,825267	0,986717
15:20	1,0361	0,7885	0,966575	1,0266	0,7848	0,945175	1,0735	0,814725	0,98735	1,050375	0,823	0,983525
15:40	1,032425	0,784925	0,962475	1,0234	0,781525	0,94175	1,070175	0,81075	0,982775	1,0468	0,819475	0,979325
16:00	1,028675	0,7821	0,959075	1,02055	0,778425	0,93725	1,06765	0,807825	0,97955	1,0451	0,8173	0,9753
16:20	1,025617	0,779417	0,955942	1,018317	0,776317	0,933292	1,064842	0,804567	0,976017	1,043417	0,814292	0,971742
16:40	1,021717	0,776817	0,952467	1,015267	0,773817	0,929967	1,061392	0,801792	0,971842	1,040492	0,811192	0,968042
17:00	1,018517	0,775217	0,949942	1,012667	0,772417	0,926442	1,058642	0,799317	0,968467	1,038017	0,808917	0,963867
17:20	1,015992	0,773267	0,947242	1,009742	0,770967	0,923467	1,055742	0,797442	0,964942	1,035592	0,807442	0,960567
17:40	1,012817	0,771217	0,944117	1,006542	0,768817	0,919317	1,053192	0,795667	0,962117	1,032967	0,806067	0,957692
18:00	1,009725	0,769825	0,942125	1,004475	0,767625	0,917025	1,05105	0,79415	0,959625	1,031375	0,80495	0,95485
18:20	1,0059	0,76725	0,938875	1,00125	0,765375	0,913475	1,048075	0,7923	0,95645	1,029225	0,80385	0,952025
18:40	1,003442	0,766192	0,936967	0,999442	0,764742	0,910867	1,045467	0,791067	0,954792	1,027642	0,803017	0,949167
19:00	1,000358	0,764833	0,934633	0,996283	0,762958	0,908083	1,043258	0,788983	0,951558	1,024558	0,801283	0,946408
19:20	0,997267	0,763567	0,932467	0,993842	0,761417	0,905242	1,040842	0,788417	0,950217	1,023542	0,800842	0,943742
19:40	0,994233	0,762283	0,930658	0,991308	0,760708	0,903558	1,037758	0,786433	0,946958	1,020508	0,799083	0,941233
20:00	0,991333	0,760608	0,928633	0,988808	0,759183	0,901008	1,035033	0,785183	0,944758	1,018333	0,797833	0,938833
20:20	0,98805	0,759825	0,926675	0,986125	0,75835	0,89875	1,03235	0,784075	0,9422	1,0166	0,797025	0,937025
20:40	0,98545	0,7584	0,925025	0,98375	0,757125	0,896075	1,03025	0,782825	0,939975	1,0141	0,79575	0,93445
21:00	0,982108	0,757233	0,922933	0,981208	0,756008	0,893833	1,027533	0,781983	0,938658	1,012433	0,794908	0,933333
21:20	0,9793	0,756875	0,921225	0,978775	0,7553	0,8922	1,025475	0,781325	0,936525	1,0104	0,79445	0,931075
21:40	0,976067	0,755292	0,919867	0,975842	0,754192	0,890117	1,022442	0,780017	0,934542	1,007767	0,793442	0,928867
22:00	0,972808	0,754633	0,918083	0,973583	0,753483	0,888083	1,020333	0,779058	0,932633	1,006058	0,792708	0,927333

APPENDICES

Table M: Average raw data of four biological replicates from OD₆₅₀ growth curve readings of single mutant CIP strains with the respective WT strains (technical parallel 3 and 4)

Time	Average CIP parallel 3					Average CIP parallel 4						
	CIP CIP 41	CIP 78	WT 22	WT 41	WT 78	Time	CP22	CIP41	CIP 78	WT 22	WT 41	WT 78
01:20	0,00335	0,00115	0,0048	0,00445	0,0034	0,0044	0,003375	0,0015	0,00505	0,003725	0,0033	0,00475
01:40	0,0072920,004867	0,010742	0,009267	0,007292	0,011342	0,0140	0,006967	0,005617	0,011392	0,008167	0,006817	0,011417
02:00	0,0149080,012633	0,024358	0,019583	0,015358	0,026683	0,0200	0,014308	0,013458	0,025033	0,018058	0,014258	0,025858
02:20	0,0309830,028783	0,054383	0,041308	0,032783	0,061658	0,0240	0,029108	0,030883	0,056233	0,038933	0,030333	0,057683
02:40	0,06355	0,062925	0,1176	0,0868	0,068875	0,13135	0,06	0,066525	0,121475	0,082025	0,064125	0,123725
03:00	0,1287250,129125	0,18575	0,154025	0,139175	0,209375	0,0300	0,122475	0,13535	0,1913	0,15645	0,131775	0,1963
03:20	0,1955330,196583	0,316783	0,251933	0,208333	0,359133	0,0320	0,186983	0,202158	0,323608	0,243558	0,195258	0,337858
03:40	0,3235580,333383	0,455558	0,402258	0,348008	0,517958	0,0340	0,311708	0,338158	0,461083	0,395858	0,329883	0,494033
04:00	0,4682580,482183	0,580958	0,533233	0,498333	0,639133	0,0400	0,447433	0,483008	0,583358	0,528683	0,477683	0,623633
04:20	0,5685750,5909	0,68745	0,6291	0,599925	0,748875	0,0420	0,5618	0,58795	0,68885	0,620625	0,583475	0,73405
04:40	0,6638330,700458	0,771683	0,717133	0,706558	0,828508	0,0440	0,659908	0,697533	0,770708	0,718583	0,695458	0,819558
05:00	0,7263750,7667	0,8296	0,77225	0,7724	0,884575	0,0500	0,730375	0,763625	0,82675	0,77685	0,7638	0,8799
05:20	0,7690670,828917	0,884117	0,823567	0,832867	0,934717	0,0520	0,772392	0,824617	0,880592	0,828867	0,826142	0,931217
05:40	0,8078830,881183	0,932008	0,867408	0,886408	0,978608	0,0540	0,813083	0,876358	0,927658	0,875308	0,880058	0,977533
06:00	0,8421830,927883	0,979083	0,906683	0,932858	1,019908	0,0600	0,848183	0,923158	0,972558	0,915558	0,927983	1,019783
06:20	0,8731420,969392	1,041317	0,942992	0,977042	1,051692	0,0620	0,879767	0,966392	1,008442	0,952167	0,973217	1,054517
06:40	0,9019081,008333	1,044133	0,980158	1,009258	1,077408	0,0640	0,909433	1,003458	1,037583	0,989958	1,006908	1,081608
07:00	0,9312671,035192	1,068217	1,008342	1,035067	1,097267	0,0700	0,940117	1,030842	1,063667	1,018667	1,034192	1,103492
07:20	0,95115	1,061725	1,086175	1,03105	1,062175	1,1109	0,961125	1,057525	1,082	1,0415	1,0626	1,118225
07:40	0,9657331,079008	1,099983	1,047683	1,076508	1,121133	0,0740	0,976108	1,072758	1,095608	1,058983	1,077758	1,129983
08:00	0,97555	1,081325	1,10895	1,05955	1,074825	1,127025	0,0800	0,987275	1,074725	1,06225	1,0705	1,107775
08:20	0,9830671,077367	1,114067	1,068692	1,069967	1,128742	0,0820	0,995117	1,071792	1,111942	1,080742	1,074717	1,138492
08:40	0,9876	1,071875	1,116925	1,0751	1,064625	1,1288	0,0840	1,0001	1,06705	1,116025	1,086525	1,06985
09:00	0,9919581,065508	1,117258	1,079133	1,058758	1,127033	0,0900	1,004633	1,059633	1,115183	1,090008	1,063358	1,137608
09:20	0,9937921,059192	1,115242	1,081167	1,052542	1,124392	0,0920	1,006592	1,051967	1,114617	1,091342	1,056242	1,135492
09:40	0,9934581,051858	1,112758	1,080908	1,045308	1,121408	0,0940	1,006458	1,044208	1,112483	1,090083	1,049158	1,133683
10:00	0,9909671,044042	1,110267	1,079417	1,037717	1,117667	0,1000	1,004842	1,037017	1,110292	1,088392	1,041842	1,130967
10:20	0,98745	1,03605	1,1068	1,076925	1,029875	1,1137	1,00225	1,0293	1,1065	1,08525	1,0341	1,126525
10:40	0,9836081,028158	1,104433	1,074433	1,020683	1,109933	0,1040	0,999183	1,022583	1,104683	1,083333	1,026658	1,123783
11:00	0,9788251,017675	1,100575	1,07055	1,008975	1,10535	0,1100	0,9947	1,013875	1,1002	1,079275	1,01705	1,11955
11:20	0,9756	1,0072	1,098175	1,067825	0,997675	1,10155	0,1120	0,991275	1,005975	1,0976	1,076425	1,0085
11:40	0,9711170,997392	1,095842	1,064967	0,986267	1,098067	0,1140	0,987417	0,997767	1,094842	1,073567	0,999792	1,112692
12:00	0,9661920,987067	1,092567	1,061742	0,975617	1,093717	0,1200	0,983067	0,989142	1,091467	1,070042	0,990692	1,108842
12:20	0,9617330,976958	1,090283	1,058433	0,964658	1,089958	0,1220	0,978983	0,981433	1,089283	1,067058	0,981983	1,105508
12:40	0,9562920,967742	1,087817	1,055067	0,954392	1,086192	0,1240	0,974967	0,973592	1,086567	1,064392	0,973642	1,101867
13:00	0,9515670,958817	1,085042	1,052417	0,945142	1,083092	0,1300	0,970767	0,966367	1,083842	1,061642	0,965917	1,098742
13:20	0,9464830,950858	1,082308	1,049233	0,935908	1,079733	0,1320	0,966258	0,958958	1,081958	1,058908	0,957883	1,095583
13:40	0,94345	0,942975	1,0802	1,04645	0,928725	1,07705	0,9629	0,951975	1,07955	1,056325	0,95045	1,0931
14:00	0,9387330,935358	1,077608	1,043283	0,920558	1,073433	0,1400	0,959633	0,945683	1,077308	1,053608	0,943358	1,089333
14:20	0,9338920,927892	1,074817	1,040667	0,913067	1,070492	0,1420	0,955942	0,939192	1,075667	1,051617	0,936592	1,086742
14:40	0,9297330,921358	1,073008	1,038233	0,906683	1,067633	0,1440	0,952533	0,933583	1,073133	1,049033	0,929783	1,083683
15:00	0,9252170,915292	1,069967	1,035842	0,900767	1,064942	0,1500	0,947917	0,927567	1,070542	1,046692	0,923817	1,081042
15:20	0,92145	0,90955	1,0681	1,033275	0,8959	1,062	0,9444	0,9218	1,06935	1,044175	0,917825	1,0784
15:40	0,9165080,904808	1,065983	1,031833	0,891408	1,060033	0,1540	0,940258	0,917558	1,068808	1,043683	0,913333	1,077083
16:00	0,9123420,899417	1,063742	1,029092	0,886767	1,056717	0,1600	0,936417	0,911967	1,065842	1,040967	0,907867	1,073667
16:20	0,9075420,895467	1,061517	1,026742	0,883242	1,054642	0,1620	0,932092	0,907242	1,063667	1,038917	0,902792	1,071317
16:40	0,9028330,891183	1,059433	1,024833	0,879658	1,052058	0,1640	0,928783	0,902433	1,061808	1,037583	0,898758	1,068608
17:00	0,8982670,887017	1,057117	1,022967	0,876217	1,049542	0,1700	0,924842	0,898592	1,059992	1,036042	0,894942	1,066617
17:20	0,8945920,884017	1,055392	1,021117	0,873942	1,047167	0,1720	0,920417	0,893792	1,057967	1,034142	0,890867	1,063692
17:40	0,8906670,880917	1,053242	1,019517	0,871842	1,044967	0,1740	0,916567	0,890117	1,056692	1,032817	0,887292	1,060967
18:00	0,8856080,877583	1,051058	1,017533	0,869183	1,042258	0,1800	0,912983	0,886458	1,054683	1,031383	0,883933	1,058733
18:20	0,8818420,875067	1,049117	1,015567	0,867717	1,040417	0,1820	0,908517	0,882467	1,052842	1,029742	0,881042	1,056917
18:40	0,8778750,872675	1,047525	1,013775	0,86585	1,038	0,1840	0,9053	0,87895	1,05145	1,02855	0,878225	1,0545
19:00	0,8731250,870475	1,0456	1,011925	0,86465	1,0361	0,1900	0,901175	0,876175	1,050125	1,027175	0,87625	1,052225
19:20	0,8688080,868008	1,043883	1,010408	0,862933	1,033558	0,1920	0,897383	0,873158	1,049033	1,026408	0,873783	1,050558
19:40	0,8648670,866342	1,041942	1,009242	0,861667	1,032517	0,1940	0,893217	0,870467	1,047217	1,024667	0,871342	1,049017
20:00	0,8606670,864692	1,040617	1,007792	0,860992	1,030317	0,2000	0,888692	0,867417	1,045892	1,023567	0,869367	1,047667
20:20	0,85635	0,86295	1,038575	1,006375	0,8597	1,02825	0,2020	0,8854	0,865475	1,044525	1,022325	0,867775
20:40	0,8513330,861258	1,036908	1,004383	0,858133	1,025808	0,2040	0,880208	0,863008	1,043233	1,021083	0,866058	1,043733
21:00	0,8471	0,860225	1,0354	1,002825	0,857525	1,023975	0,2100	0,87625	0,860825	1,0419	1,020125	0,864225
21:20	0,8436330,859108	1,034458	1,001758	0,857058	1,022908	0,2120	0,871883	0,858358	1,040258	1,018558	0,862833	1,040108
21:40	0,8386580,857683	1,032858	0,999858	0,855783	1,021018	0,2140	0,867383	0,857083	1,039633	1,017458	0,861958	1,038208
22:00	0,8342	0,856925	1,031575	0,998225	0,8552	1,018825	0,2200	0,8626	0,855125	1,038175	1,0162	0,8603
22:20	0,8294250,855725	1,029625	0,99615	0,85415	1,016025	0,2220	0,8579	0,85335	1,036675	1,01495	0,85945	1,03405

APPENDICES

Table N: Average raw data of four biological replicates from OD₆₅₀ growth curve readings of double mutant TP+CIP strains with the respective WT strains (technical parallel 1 and 2)

Average TP+CIP parallel 1					Average TP+CIP parallel 2								
Time	CIP+TP 22	CIP+TP 41	CIP+TP 78	WT 22	WT 41	WT 78	Time	CIP+TP 22	CIP+TP 41	CIP+TP 78	WT 22	WT 41	WT 78
01:20	0,008883	0,008033	0,008183	0,006308	0,004233	0,008783	01:20	0,006733	0,005233	0,008508	0,005933	0,005733	0,009558
01:40	0,016992	0,016417	0,014617	0,012467	0,008642	0,019267	01:40	0,012867	0,011617	0,015192	0,011467	0,009917	0,020467
02:00	0,035017	0,035692	0,029817	0,025267	0,018167	0,043467	02:00	0,026042	0,025267	0,029642	0,022267	0,018342	0,045492
02:20	0,074992	0,078217	0,060842	0,052592	0,038392	0,096317	02:20	0,055442	0,056467	0,060642	0,046392	0,037042	0,099867
02:40	0,151875	0,150925	0,1253	0,108475	0,08095	0,16955	02:40	0,119475	0,12085	0,123875	0,094125	0,07535	0,17375
03:00	0,238208	0,250533	0,201158	0,174683	0,152283	0,289533	03:00	0,192533	0,193958	0,196008	0,163658	0,150508	0,295633
03:20	0,386042	0,413317	0,339592	0,295567	0,238617	0,458267	03:20	0,330192	0,332242	0,328567	0,264242	0,220417	0,464267
03:40	0,54595	0,579625	0,4821	0,443775	0,38905	0,61075	03:40	0,482225	0,494825	0,469	0,416475	0,366725	0,614825
04:00	0,649625	0,677675	0,6185	0,5658	0,543725	0,71495	04:00	0,61255	0,6244	0,6072	0,546325	0,528225	0,719625
04:20	0,7503	0,78575	0,72165	0,664925	0,641725	0,813575	04:20	0,71515	0,730125	0,71005	0,641775	0,62115	0,818025
04:40	0,817367	0,856067	0,805692	0,731142	0,733467	0,881392	04:40	0,799642	0,819017	0,797117	0,728917	0,725242	0,885567
05:00	0,868975	0,91305	0,868725	0,784	0,797625	0,937125	05:00	0,8569	0,87925	0,8626	0,781675	0,7897	0,9419
05:20	0,917283	0,962683	0,919483	0,833533	0,856958	0,984983	05:20	0,910608	0,934808	0,914758	0,831458	0,852108	0,989408
05:40	0,956717	1,005392	0,959667	0,875492	0,906217	1,026292	05:40	0,955067	0,981792	0,955867	0,875867	0,904267	1,031017
06:00	0,992525	1,043275	0,997575	0,914625	0,95075	1,0657	06:00	0,993825	1,022675	0,99475	0,915375	0,949775	1,0706
06:20	1,026792	1,079167	1,032217	0,953042	0,993417	1,095717	06:20	1,031192	1,062392	1,032542	0,953692	0,992442	1,100642
06:40	1,054458	1,106233	1,052483	0,989858	1,024608	1,118983	06:40	1,061633	1,092708	1,054833	0,992208	1,028158	1,124758
07:00	1,076942	1,127642	1,067217	1,017392	1,050942	1,138667	07:00	1,086392	1,118342	1,071467	1,020867	1,056467	1,144892
07:20	1,093658	1,144758	1,078033	1,038558	1,076033	1,153758	07:20	1,107458	1,139283	1,084183	1,042558	1,080608	1,160008
07:40	1,105383	1,155983	1,086308	1,055958	1,093008	1,164183	07:40	1,122333	1,155108	1,093758	1,058958	1,102983	1,171133
08:00	1,112617	1,162517	1,091592	1,069167	1,095267	1,170342	08:00	1,132742	1,164342	1,100817	1,072317	1,111917	1,177717
08:20	1,11625	1,165225	1,09525	1,079625	1,0904	1,1713	08:20	1,139525	1,170175	1,105675	1,083325	1,109625	1,179575
08:40	1,11755	1,1649	1,0975	1,08675	1,085275	1,171425	08:40	1,143025	1,17175	1,1094	1,091975	1,10555	1,18005
09:00	1,116533	1,164008	1,098633	1,091658	1,079408	1,169858	09:00	1,143583	1,171308	1,111833	1,097033	1,100958	1,179158
09:20	1,113792	1,161867	1,099817	1,092767	1,073867	1,168717	09:20	1,142117	1,169742	1,113642	1,098617	1,095417	1,172767
09:40	1,110392	1,159667	1,100042	1,092142	1,067667	1,165117	09:40	1,139617	1,168092	1,115192	1,099217	1,088917	1,174817
10:00	1,106725	1,156875	1,098925	1,09035	1,06185	1,1626	10:00	1,136725	1,1658	1,11515	1,098425	1,082575	1,171925
10:20	1,102617	1,154067	1,097967	1,087967	1,054717	1,159142	10:20	1,133342	1,162917	1,114917	1,096992	1,075767	1,168617
10:40	1,098125	1,15085	1,095675	1,085225	1,045775	1,1556	10:40	1,1303	1,16045	1,11435	1,09585	1,069225	1,165575
11:00	1,094092	1,147867	1,093817	1,082267	1,035492	1,151967	11:00	1,126292	1,157492	1,113067	1,093942	1,061667	1,162667
11:20	1,090525	1,1441	1,091975	1,0793	1,024375	1,14975	11:20	1,123125	1,1538	1,1109	1,091325	1,053625	1,1594
11:40	1,087033	1,140683	1,089583	1,076208	1,012383	1,146408	11:40	1,119808	1,150233	1,108683	1,088908	1,044633	1,156458
12:00	1,082508	1,137683	1,086633	1,073033	1,000658	1,143958	12:00	1,116933	1,148058	1,107583	1,086783	1,036783	1,153983
12:20	1,079575	1,13435	1,084175	1,070525	0,989975	1,141025	12:20	1,113975	1,1445	1,10575	1,084225	1,027775	1,151575
12:40	1,076658	1,130758	1,081733	1,066708	0,979058	1,138933	12:40	1,110958	1,140858	1,102108	1,081733	1,019283	1,148508
13:00	1,07355	1,127625	1,078875	1,064375	0,968425	1,135925	13:00	1,107875	1,13765	1,1004	1,07945	1,01145	1,1461
13:20	1,070617	1,123792	1,076792	1,061242	0,959067	1,133592	13:20	1,104842	1,134217	1,097817	1,076292	1,003342	1,142917
13:40	1,067883	1,120258	1,073558	1,058433	0,949733	1,130108	13:40	1,102083	1,131258	1,095083	1,073958	0,995658	1,140533
14:00	1,065175	1,117	1,070675	1,055225	0,940725	1,12745	14:00	1,09955	1,128375	1,092625	1,07115	0,988575	1,1382
14:20	1,062367	1,113617	1,067667	1,052617	0,932992	1,125892	14:20	1,096892	1,125392	1,090267	1,068592	0,981367	1,135892
14:40	1,058825	1,10915	1,063975	1,0487	0,9251	1,122875	14:40	1,0944	1,121775	1,087375	1,06635	0,9745	1,1339
15:00	1,056408	1,105283	1,060633	1,045333	0,918608	1,120533	15:00	1,091683	1,118708	1,084533	1,063483	0,968558	1,131733
15:20	1,053108	1,101708	1,057258	1,042058	0,912583	1,116633	15:20	1,089133	1,115583	1,081483	1,061033	0,962708	1,128983
15:40	1,050575	1,0977	1,053825	1,0388	0,9074	1,114725	15:40	1,0867	1,111625	1,078575	1,058	0,9572	1,12695
16:00	1,04695	1,09295	1,049925	1,0358	0,903	1,1133	16:00	1,0845	1,10825	1,07565	1,056	0,9526	1,125375
16:20	1,044983	1,089558	1,046783	1,032908	0,899283	1,109283	16:20	1,081883	1,104358	1,072333	1,053483	0,948208	1,122908
16:40	1,041275	1,08465	1,0428	1,02965	0,895125	1,10605	16:40	1,079175	1,1013	1,0695	1,051125	0,943475	1,1207
17:00	1,03955	1,081075	1,039525	1,026525	0,892325	1,1036	17:00	1,07685	1,097725	1,06635	1,04855	0,939575	1,11855
17:20	1,036167	1,077767	1,036167	1,023367	0,889967	1,101242	17:20	1,074217	1,094442	1,063492	1,046292	0,936042	1,116067
17:40	1,033867	1,074017	1,033267	1,020392	0,887692	1,098867	17:40	1,071242	1,090667	1,060442	1,043867	0,932917	1,114067
18:00	1,03085	1,070125	1,02955	1,017575	0,88505	1,095975	18:00	1,0689	1,0871	1,0574	1,04195	0,929675	1,111875
18:20	1,028425	1,066475	1,02655	1,01455	0,88365	1,093275	18:20	1,066675	1,084125	1,055175	1,0395	0,9274	1,109775
18:40	1,025275	1,0627	1,02315	1,01135	0,881125	1,0903	18:40	1,0637	1,080825	1,052225	1,037025	0,924325	1,1076
19:00	1,022025	1,059575	1,020075	1,009275	0,87955	1,08745	19:00	1,06185	1,079075	1,050825	1,035825	0,922475	1,106025
19:20	1,020192	1,055967	1,017117	1,006017	0,878042	1,084542	19:20	1,058617	1,074417	1,046917	1,032867	0,919842	1,103217
19:40	1,016908	1,052408	1,014158	1,003483	0,876033	1,082083	19:40	1,056083	1,071783	1,044958	1,031108	0,918033	1,101433
20:00	1,0143	1,049175	1,011475	1,000575	0,87465	1,079125	20:00	1,0537	1,068975	1,042675	1,0292	0,916	1,09915
20:20	1,011742	1,045817	1,009017	0,997917	0,873817	1,077067	20:20	1,050767	1,064667	1,039392	1,026317	0,913392	1,097692
20:40	1,009167	1,042642	1,006192	0,994717	0,871667	1,073967	20:40	1,047992	1,061492	1,036667	1,024142	0,911267	1,095592
21:00	1,006292	1,038767	1,003392	0,991542	0,870142	1,071167	21:00	1,044917	1,058542	1,034317	1,021842	0,909217	1,092967
21:20	1,003158	1,035683	1,000208	0,988608	0,868833	1,068033	21:20	1,042733	1,055958	1,032033	1,019533	0,907508	1,091208
21:40	1,000725	1,0329	0,997525	0,985475	0,868	1,065	21:40	1,03985	1,05345	1,02915	1,0172	0,905775	1,08895
22:00	0,99805	1,030175	0,994325	0,98255	0,866825	1,062125	22:00	1,03695	1,05075	1,026925	1,0152	0,904	1,086475
22:20	0,995292	1,027792	0,992267	0,980192	0,866267	1,058742	22:20	1,034367	1,048017	1,024742	1,012942	0,902442	1,084192

APPENDICES

Table O: Average raw data of four biological replicates from OD₆₅₀ growth curve readings of double mutant TP+CIP strains with the respective WT strains (technical parallel 3 and 4)

Average TP+CIP parallel 3							Average TP+CIP parallel 4						
Tim	CIP+TP22	CIP+TP 41	CIP+TP 78	WT 22	WT 41	WT 78	Time	CIP+TP 22	CIP+TP 41	CIP+TP 78	WT 22	WT 41	WT 78
01:20	0,005975	0,00815	0,00895	0,00625	0,005075	0,008783	01:20	0,004825	0,00675	0,005975	0,0051	0,0049	0,008783
01:40	0,013308	0,017358	0,016883	0,011208	0,010733	0,019267	01:40	0,011033	0,015258	0,013033	0,010233	0,010708	0,019267
02:00	0,030525	0,038625	0,03505	0,02235	0,02315	0,043467	02:00	0,0254	0,034525	0,029325	0,02185	0,024	0,043467
02:20	0,06785	0,0835	0,0733	0,046	0,04985	0,096317	02:20	0,056475	0,075225	0,0624	0,045775	0,050575	0,096317
02:40	0,124758	0,141983	0,124483	0,092608	0,101783	0,16955	02:40	0,115783	0,130108	0,114508	0,092908	0,102433	0,16955
03:00	0,210775	0,2492	0,21325	0,149425	0,156025	0,289533	03:00	0,181	0,227175	0,188025	0,151	0,156275	0,289533
03:20	0,350175	0,411275	0,354625	0,256175	0,269725	0,458267	03:20	0,312625	0,3893	0,321675	0,258575	0,2696	0,458267
03:40	0,508908	0,571958	0,518708	0,409658	0,421508	0,61075	03:40	0,466958	0,558133	0,475908	0,412933	0,422583	0,61075
04:00	0,624308	0,672308	0,632258	0,546658	0,544733	0,71495	04:00	0,600258	0,652858	0,603683	0,547208	0,544133	0,71495
04:20	0,722508	0,765233	0,736608	0,651783	0,652933	0,813575	04:20	0,700808	0,754883	0,713933	0,654208	0,650908	0,813575
04:40	0,784725	0,825625	0,807675	0,7194	0,7202	0,881392	04:40	0,7721	0,815875	0,78955	0,723225	0,722325	0,881392
05:00	0,838783	0,879608	0,859733	0,774283	0,777683	0,937125	05:00	0,829658	0,871583	0,845658	0,777733	0,776983	0,937125
05:20	0,88225	0,915625	0,905775	0,824275	0,821975	0,984983	05:20	0,876325	0,910175	0,894125	0,828275	0,820675	0,984983
05:40	0,914117	0,942517	0,939142	0,870292	0,850742	1,026292	05:40	0,909767	0,939242	0,930242	0,874242	0,850242	1,026292
06:00	0,940608	0,966108	0,967658	0,915983	0,874958	1,0657	06:00	0,936608	0,964333	0,960983	0,921533	0,872333	1,0657
06:20	0,962075	0,98635	0,991525	0,95735	0,8896	1,095717	06:20	0,958475	0,9863	0,986725	0,961025	0,8881	1,095717
06:40	0,981117	1,005492	1,011092	0,990367	0,906817	1,118983	06:40	0,977842	1,006342	1,006592	0,994342	0,905717	1,118983
07:00	1,001933	1,024633	1,024658	1,017583	0,919408	1,138667	07:00	0,997133	1,027133	1,022183	1,020933	0,919533	1,138667
07:20	1,018508	1,036633	1,038358	1,039058	0,937033	1,153758	07:20	1,019658	1,039233	1,036708	1,043183	0,937633	1,153758
07:40	1,0335	1,050375	1,050175	1,058375	0,9548	1,164183	07:40	1,037825	1,05435	1,053625	1,066725	0,957425	1,164183
08:00	1,0404	1,0584	1,0568	1,0727	0,966575	1,170342	08:00	1,047575	1,064825	1,062725	1,082125	0,967475	1,170342
08:20	1,043075	1,05825	1,0582	1,08235	0,929875	1,1713	08:20	1,052	1,065675	1,066175	1,09075	0,930425	1,1713
08:40	1,040742	1,053142	1,056617	1,089342	0,902542	1,171425	08:40	1,051517	1,062142	1,066217	1,093067	0,905342	1,171425
09:00	1,036258	1,045258	1,053808	1,093008	0,889158	1,169858	09:00	1,047583	1,055983	1,064258	1,092558	0,890283	1,169858
09:20	1,03065	1,0378	1,0503	1,093725	0,88015	1,168717	09:20	1,042525	1,0487	1,06195	1,09165	0,8829	1,168717
09:40	1,023483	1,030858	1,046133	1,092833	0,873233	1,165117	09:40	1,035708	1,041908	1,058808	1,089983	0,876408	1,165117
10:00	1,017233	1,026608	1,040583	1,091058	0,866533	1,1626	10:00	1,030083	1,036633	1,055308	1,088558	0,870383	1,1626
10:20	1,011225	1,0215	1,0342	1,088525	0,85875	1,159142	10:20	1,024525	1,031025	1,050425	1,086525	0,8641	1,159142
10:40	1,005833	1,015358	1,028258	1,086083	0,851333	1,1556	10:40	1,019508	1,025658	1,044958	1,083983	0,857233	1,1556
11:00	1,000817	1,009392	1,021842	1,082542	0,843367	1,151967	11:00	1,013767	1,019817	1,040017	1,080542	0,850317	1,151967
11:20	0,995158	1,003883	1,017008	1,079308	0,836533	1,14975	11:20	1,008958	1,014608	1,034658	1,077983	0,844083	1,14975
11:40	0,989783	0,997808	1,011808	1,075783	0,830183	1,146408	11:40	1,004558	1,009808	1,030258	1,075508	0,838783	1,146408
12:00	0,984358	0,992308	1,007433	1,071933	0,823933	1,143958	12:00	0,999883	1,004383	1,026083	1,073133	0,834283	1,143958
12:20	0,979333	0,987333	1,002908	1,068183	0,817408	1,141025	12:20	0,994633	0,999833	1,021858	1,069908	0,828733	1,141025
12:40	0,974008	0,981858	0,998358	1,063958	0,809958	1,138933	12:40	0,990808	0,994983	1,018383	1,067458	0,823533	1,138933
13:00	0,968592	0,976567	0,994667	1,059967	0,802992	1,135925	13:00	0,985742	0,991567	1,014692	1,064192	0,817617	1,135925
13:20	0,965183	0,971608	0,990733	1,055558	0,797208	1,133592	13:20	0,981683	0,986708	1,011258	1,059958	0,812458	1,133592
13:40	0,960642	0,966942	0,987367	1,051642	0,792692	1,130108	13:40	0,977692	0,982842	1,008192	1,057117	0,808317	1,130108
14:00	0,956533	0,962108	0,984083	1,047508	0,788458	1,12745	14:00	0,974358	0,979183	1,005608	1,055283	0,803983	1,12745
14:20	0,952625	0,957425	0,980925	1,04365	0,785225	1,125892	14:20	0,97065	0,97575	1,0027	1,051525	0,800775	1,125892
14:40	0,948558	0,953133	0,977883	1,039633	0,782508	1,122875	14:40	0,967658	0,971558	1,000283	1,048658	0,797808	1,122875
15:00	0,945425	0,949175	0,97485	1,036775	0,780025	1,120533	15:00	0,9648	0,96845	0,9979	1,0463	0,795425	1,120533
15:20	0,942058	0,945508	0,971558	1,033508	0,776683	1,116633	15:20	0,962033	0,965408	0,995283	1,043733	0,793008	1,116633
15:40	0,938617	0,941742	0,968217	1,030517	0,772842	1,114725	15:40	0,959092	0,961917	0,992767	1,041142	0,790217	1,114725
16:00	0,935133	0,938108	0,965308	1,027583	0,769033	1,1133	16:00	0,956383	0,958983	0,990708	1,038758	0,787583	1,1133
16:20	0,931692	0,934792	0,962242	1,024917	0,766642	1,109283	16:20	0,953692	0,956617	0,988992	1,036967	0,785417	1,109283
16:40	0,928425	0,931525	0,95955	1,0226	0,764425	1,10605	16:40	0,95105	0,953475	0,986625	1,034725	0,7828	1,10605
17:00	0,925533	0,928908	0,956633	1,019683	0,763108	1,1036	17:00	0,948008	0,950833	0,984408	1,031933	0,780658	1,1036
17:20	0,922042	0,926067	0,954067	1,016817	0,761192	1,101242	17:20	0,945417	0,948142	0,982792	1,030317	0,778692	1,101242
17:40	0,919725	0,9238	0,9515	1,0148	0,7603	1,098867	17:40	0,94315	0,94585	0,98065	1,0282	0,777275	1,098867
18:00	0,917317	0,921842	0,948917	1,012292	0,759717	1,095975	18:00	0,940692	0,943617	0,978767	1,026342	0,775867	1,095975
18:20	0,913567	0,919017	0,946217	1,009692	0,757667	1,093275	18:20	0,937692	0,941442	0,976867	1,024592	0,774567	1,093275
18:40	0,910667	0,916892	0,943617	1,007117	0,756317	1,0903	18:40	0,935667	0,939617	0,974542	1,022717	0,773392	1,0903
19:00	0,908392	0,915292	0,941442	1,005042	0,755092	1,08745	19:00	0,933517	0,937917	0,972742	1,021242	0,771967	1,08745
19:20	0,905408	0,913383	0,939108	1,002733	0,754033	1,084542	19:20	0,930858	0,936108	0,970508	1,019858	0,771108	1,084542
19:40	0,903358	0,911708	0,937258	1,000308	0,752408	1,082083	19:40	0,929058	0,934908	0,968883	1,017808	0,769883	1,082083
20:00	0,901408	0,910783	0,934708	0,998383	0,751983	1,079125	20:00	0,927083	0,932833	0,966658	1,016133	0,768608	1,079125
20:20	0,898833	0,908908	0,932708	0,995808	0,751008	1,077067	20:20	0,923958	0,931058	0,964383	1,014083	0,767183	1,077067
20:40	0,895808	0,907133	0,930483	0,993358	0,749708	1,073967	20:40	0,922333	0,929933	0,962983	1,012833	0,766708	1,073967
21:00	0,89315	0,905625	0,928225	0,990675	0,748725	1,071167	21:00	0,91965	0,9287	0,9614	1,010875	0,765525	1,071167
21:20	0,890325	0,9044	0,92665	0,988425	0,74835	1,068033	21:20	0,917725	0,92735	0,95955	1,009225	0,7646	1,068033
21:40	0,88715	0,9031	0,92415	0,986025	0,7472	1,065	21:40	0,915425	0,925875	0,9578	1,007475	0,7636	1,065
22:00	0,885458	0,902308	0,923208	0,983908	0,747408	1,062125	22:00	0,913258	0,924558	0,956308	1,005783	0,762708	1,062125
22:20	0,881725	0,900825	0,9207	0,98105	0,74625	1,058742	22:20	0,910375	0,923575	0,95445	1,00395	0,76185	1,058742

APPENDICES

Appendix 4: Calculated relative generation time and significant differences

Table P: The calculation of generation time in averages, standard deviations, standard errors and 95% confidence intervals for each replicate for all single and double mutants with their respective wild type strains.

N	TP22	TP41	TP78	WT22	WT41	WT78	Relative value			P-value with the α set to 0,05
							WT22/TP2	WT41/TP4	WT78/TP4	
1	40	29	28	28,8	24	27	2	1	1	T-test 95% K.I. for TP22
2	38	28	28	28,9	30	27	0,72	0,82758621	0,96428571	0,00054145
3	38	29	31	28,8	28	31	0,75789474	0,96551724	1	T-test 95% K.I. for TP41
4	37	31	30	29,2	31	29	0,78918919	1	0,96666667	0,582014
Mean	38	29	29	28,9	28	29	0,75620915	0,96581197	0,97435897	
st.dev	1,25830574	1,25830574	1,5	0,18929694	3,09569594	1,91485422	0,02839214	0,10235514	0,01749636	
st.error	0,62915287	0,62915287	0,75	0,09464847	1,54784797	0,95742711	0,01419607	0,05117757	0,00874818	T-test 95% K.I. for TP78
K.I	1,2331170	1,2331170	1,4699730	0,1855076	3,0337263	1,8765226	0,0278238	0,1003062	0,0171461	0,56135793

N	CIP22	CIP41	CIP78	WT22	WT41	WT78	Relative values			P-value with the α set to 0,05
							WT22/CIP22	WT41/CIP41	WT78/CIP78	
1	28	27	27	27	29	30	0,96428571	1,07407407	1,11111111	T-test 95% K.I. for CIP22
2	27	27	27	28	32	29	1,03703704	1,18518519	1,07407407	0,43777289
3	32	28	31	29	33	28	0,90625	1,17857143	0,90322581	T-test 95% K.I. for CIP41
4	32	33	31	30	30	30	0,9375	0,90909091	0,96774194	0,24246331
Mean	30	29	29	29	31	29	0,95798319	1,07826087	1,00862069	
st.dev	2,62995564	2,87228132	2,30940108	1,29099445	1,82574186	0,95742711	0,05580308	0,12889801	0,09565596	T-test 95% K.I. for CIP78
st.error	1,31497782	1,43614066	1,15470054	0,64549722	0,91287093	0,47871355	0,02790154	0,064449	0,04782798	0,85123317
K.I	2,57730917	2,81478397	2,26317147	1,26515131	1,78919414	0,93826132	0,05468602	0,12631773	0,09374112	

N	TP+CIP22	TP+CIP41	TP+CIP78	WT22	WT41	WT78	Relative values			P-value with the α set to 0,05
							WT22/TP+CIP22	WT41/TP+CIP41	WT78/TP+CIP78	
1	33	28	31	30	30	27,9	0,90909091	1,07142857	0,9	T-test 95% K.I. for TP+CIP22
2	30	30	31	30	31	28,2	1	1,03333333	0,90967742	0,17848423
3	30	27	29	27	23	27,9	0,9	0,85185185	0,96206897	T-test 95% K.I. for TP+CIP41
4	29	29	30	28	28	27,9	0,96551724	0,96551724	0,93	0,80545946
Mean	31	29	30	29	28	28,0	0,94262295	0,98245614	0,92479339	
st.dev	1,73205081	1,29099445	0,95742711	1,5	3,55902608	0,15	0,04744524	0,09632271	0,02743554	T-test 95% K.I. for TP78
st.error	0,8660254	0,64549722	0,47871355	0,75	1,77951304	0,075	0,02372262	0,04816135	0,01371777	0,01640604
K.I	1,6973786	1,26515131	0,93826132	1,46997299	3,48778147	0,1469973	0,04649548	0,09439452	0,02688634	

Appendix 5: Molecular weight standard: SmartLadder MW-1700-10 (Eurogentec)

Figure C: Figure illustrating molecular marker (SmartLadder) used in gel electrophoresis. Information about this product can be found on producers' web page:

<http://www.eurogentec.com/uploads/TDS-MW-1700-10.pdf>

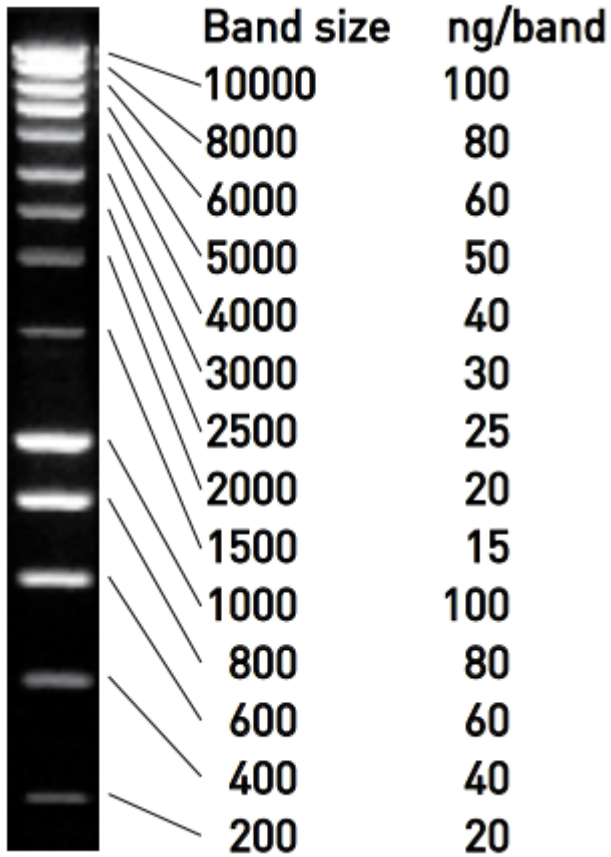