



UIT

THE ARCTIC
UNIVERSITY
OF NORWAY

Institutt for datateknologi og beregningsorienterte ingeniørfag

Elevator model

Design of an elevator model for teaching in the field of automation

—

Eeke Nijdam

Master's thesis in engineering design, 29th January 2019 – 11th June 2019



Table of Contents

1	Introduction.....	1
2	Problem description	2
2.1	Who has the problem?	2
2.2	What is the problem?	2
2.3	What are the objectives?.....	2
2.4	What are the side effects that should be avoided?	2
2.5	What options are open?.....	2
3	Market research	3
3.1	What wishes does the customer have?.....	3
3.2	What is already present in the market?	4
	Model A: Feedback 34-150	5
	Model B: Dolang Education DLPLC-DT1	6
	Model C: Industrial Concepts	7
4	Short analysis of former proposals	8
4.1	Introduction	8
4.2	Useful and interesting information	8
4.3	Challenge	8
5	Function Analysis.....	8
6	Set of requirements	9
6.1	Requirements	9
6.2	Wishes.....	10
7	Ergonomics.....	10
8	Morphological overview.....	12
9	Ideas and concepts.....	13
9.1	Concept 1.....	14

9.2	Concept 2.....	15
9.3	Concept 3.....	16
9.4	Ideas.....	17
10	Quality function deployment	19
11	Concept choice	21
12	Final design.....	21
13	Material selection.....	22
13.1	Defining the design requirements	22
	Functions	22
	Objectives.....	23
	Constraints	23
	Free variables	23
13.2	Material charts.....	23
13.3	Choice of materials	24
	Final choice.....	25
14	Calculations	25
15	Cost price.....	26
16	Conclusion and continuation	27
	Sources	28
	Books	28
	Webistes.....	28
	Documents	28
	Programs	29
	Appendix 1: Overview operation buttons.....	29
	Appendix 2: Elevator model for Programmable Logic Controller	30
	Appendix 3: QFD-house A3	32

Appendix 4: PLS program for model elevator (created in Syswin)	33
Appendix 5: Cost price calculation	36

List of Tables

Table 1: Requirements model elevator.....	9
Table 2: Wishes elevator model.....	10
Table 3: Overview of different types of operation buttons including general design guidelines [4]	11
Table 4: Morphological overview elevator model	12
Table 5: Material properties (CES Edupack 2018).....	24
Table 6: Processing energy and CO ₂ footprint (CES Edupack 2018)	24
Table 7: Material properties PMMA (Ansys).....	25
Table 8: Cost price calculation elevator model.....	26
Table 9: Network instructions Syswin	34
Table 10: Cost price calculation information	36

List of Figures

Figure 1: Model options [12].....	3
Figure 2: Model elevator Feedback [6 and 7]	5
Figure 3: Model elevator Dolang Education [8 and 9]	6
Figure 4: Model elevator Industrial Concepts LLC [10]	7
Figure 5: Concept 1 (Inventor)	14
Figure 6: Concept 2 (Inventor)	15
Figure 7: Concept 3 (Inventor)	16
Figure 8: Proposal with the same back and side parts (Inventor)	17
Figure 9: Different proposals for stop buttons (Inventor)	17
Figure 10: Elevator model with basement and magnet connection between elevator compartment and rope (Inventor).....	18
Figure 11: Door in elevator compartment (Inventor)	18
Figure 12: QFD-house model elevator	20

Figure 13: Final design model elevator (Inventor)	21
Figure 14: Assembly of the frame, elevator compartment and panel (Inventor)	22
Figure 15: Stages 1-3 in the material choice for the elevator model (CES Edupack 2018).....	23
Figure 16: Displacement and maximum stress of elevator compartment (Ansys) and frame (Ansys and SolidWorks)	25
Figure 17: Overview of different types of operation buttons including general design guidelines [4]	29
Figure 18: Overview of inputs and outputs to the PLC [13]	30
Figure 19: Overview of the connections [13]	31
Figure 20: QFD-house model elevator	32
Figure 21: PLS program (Syswin)	34

Foreword

For the master of Engineering Design at UiT, the arctic university of Norway, campus Narvik, a master assignment is being executed as a conclusion to the study. In this case the department of industrial automation education had an elevator model design assignment that could be done by an Engineering Design student. This report describes a summary of the design process that has been executed and the results that were obtained. This includes some information about the problem description, market research, function analysis, set of requirements, ergonomics check, morphological overview with resulting concepts, final choice based on quality function deployment, material selection, strength analysis (including tilting check) and feasibility to continue and produce this product locally.

1 Introduction

UiT, the arctic university of Norway, campus Narvik has been using models of elevators in industrial automation education. A small private company in Narvik produced the original elevator models in the 80's. The models were made by hand in Plexiglas and consist of many small parts. There are relatively few electrical components in the models, these are simple and need to be replaced rarely.

What characterizes the models is that they are made of transparent material and the interior design is clearly shown.

The same models have been used for over 30 years and proved to be robust and safe from failure. Several tasks have been developed that are based on the use of the models and are proven to have a significant learning effect. An example of such a program can be found in appendix 4, the PLS connections can be found in appendix 2.

The simple and reliable construction of the models combined with a clear learning outcome with the models in teaching, leads to the question whether a new model can be developed into a commercial product intended for use in the teaching industry.

Therefore a master thesis assignment has been created to investigate this possibility and propose a possible design. The main task is to redesign the existing model with three floors. The model should look cool and it should be interesting for the students to work with the model. The model should be fit for usage in industrial automation subjects at all levels, from secondary school to university. The model should be cheap and simple so that educational institutions can acquire class sets of 5 - 10 models and run laboratory exercises and projects for many students at the same time. The user experience and first impression is important.

Task description from the industrial automation department:

- a) Create an ideal model without taking into account production methods. Assuming that in a few years, 3D printers will handle all tasks or develop other production methods. Prototype does not have to be transparent.
- b) Assume that the model will be (mass) produced using today's methods.

2 Problem description

2.1 Who has the problem?

Both schools and universities that teach programming of PLC's (Programmable Logic Controllers) and want to demonstrate it with a practical model, so students can see clearly whether their programming is correct or incorrect.

2.2 What is the problem?

To have an affordable elevator-model on the market that is large enough to show what happens with certain programming, but that is not too heavy to carry around to other classrooms when needed and that has a modern enough look so students will enjoy working with it.

2.3 What are the objectives?

To create a model lift at table size, with light, modern materials, affordable enough so schools can easily purchase several models. Electrical parts will have to be inside the model due to regulations.

2.4 What are the side effects that should be avoided?

Choosing materials or production methods that are not widely available or creating a construction that is very complex to assemble.

2.5 What options are open?

All solutions that are affordable, strong and light enough and easy enough to use for the students.

3 Market research

3.1 What wishes does the customer have?

The industrial automation department of UiT defined amongst others the following wishes:

- The model shall consist of the fewest parts possible and have to be easy to manufacture and assemble using screws, clips or glue.
- Size: Not too small – it should look solid enough. Not too big – if the distance between floors is large, then it takes a long time to test/ troubleshoot the programming.
- The model must be able to be mass produced (1000 pieces).
- Material selection: The new elevator models must be of a scratch-resistant, transparent, possibly coloured plastic, so that interior design is clearly visible. It may also be considered whether the surface of the models should be completely blank or possibly partially with a rough/ patterned surface to avoid scratches or partially transparent with parts of a different colour.
- Furthermore it should resist mechanical stresses, be scratch-resistant, the price should be taken into account and should not be too high and different alternatives should be considered.
- The model should be able to be repaired if necessary and if possible with replaceable parts to be able to remove scratched parts.
- Other things that can be taken into account is whether it is possible to use recycled plastic bottles from Bjerkvik for example.
- Preferred production methods: Vacuum moulding, injection moulding, 3D printing, laser milling
- Take into account what possibilities UiT has for prototype production and possibly mass production to be able to sell the product to other schools and universities.
- Design: There should be enough space for (a) circuit board(s); buttons and lights are needed for the several levels, signal generators are needed in the floors, top and bottom.
- The connections with banana plugs, flat cable, etc. must be able to withstand at least a 1000 connections.
- Perhaps different styles can be used, like the Tower of Pisa, the Chrysler Building, the Neuschwanstein Castle, Modern Architecture, the Rockefeller centre, etc.
- Instead of just a table model, maybe also a wall-mounted variant and possibly more options can be developed:

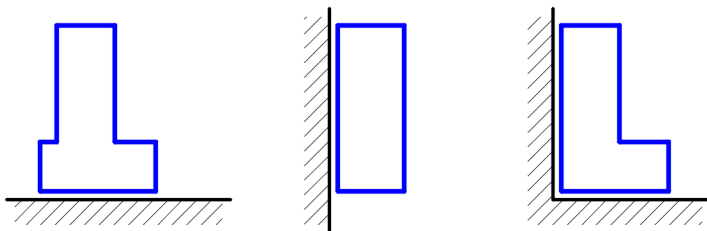

Figure 1: Model options [12]

- The model must be relatively easy to open for repair/ replacement of parts – If we assume that this is done once a year, it should therefore withstand 20 - 30 cycles open/ close during lifetime.
- It is not necessary with doors, but if applied, they should open by hand and not by extra motors.
- The elevator part can be a simple 2D version, but would be cooler with a 3D version, so it can hold Lego figures for example.

- The buttons and floors can either have an own big circuit board (as on some models today) or a small circuit board on each floor. It can also be done without circuit boards, only with wires. For the circuit boards, it can be decided to use either transparent or coloured circuit boards.
- Maybe it is possible to use touch screen.
- Common mistakes that students make when programming, is that the elevator does not stop on the way up after the 3rd floor and hits the ceiling or when it goes down after the 1st floor and it touches the bottom. This is a part of the learning process, but it would be nice if the students experience that they need to do an extra action, when they made programming mistakes. Maybe the elevator part can fall down when this happens, but it should be easy to repair. To avoid big damage as breaking wires, maybe a built in protection can be made: for example that when the elevator hits the ceiling, the electrical circuit breaks, so that the engine stops.
- Basically, the elevator could hang somewhere between two different floors. Therefore it should be possible to lift/ lower the elevator (by hand, or with manual mode) to the nearest floor.
- Power supply: either an external power supply can be used, or it can be researched whether it is possible to use the PLC as a power supply or even maybe solar cells.
- The elevator should have a demo mode in which the elevator should be able to run up and down without the controller.
- The motor needs a kind of rotary knob to adjust engine speed from approximately zero to approximately 2 times normal speed, both in manual and auto mode
- There should be an emergency button to stop the motor
- Today's model has switches to change direction of rotation of the motor and neutral position; check whether this is necessary or how it can be solved otherwise.
- Engine selection: different types could be used, but the following things should be taken into account: voltage, gear, torque, low noise, adjustable speed with preferably circa the same speed on the way up as down (depending a little on the load)
- There should be a possibility to exchange the motor so that also motors from other suppliers can be used, without the consequence of applying any major changes in the construction. (In this case it might also be possible to use the motor for other purposes/ other models.)
- Different types of signal generators and end-switches in addition to reed relays can be considered and the same applies to the selection of buttons and LED's, Prell-free switches
- Check whether a stop button (rest contact) is needed or not.
- Perhaps a red light "alarm" (flashing LED) or an acoustic signal can be added in case of a programming mistake. In case of an acoustic alarm, it should be able to be disabled in case of too much noise in the classrooms.
- Stability is important in this model, so a low centre of gravity is wished for.
- "Elevator" buttons can be made quite realistic, as can floor markings for example. Check the possibilities and come up with a nice design!

3.2 What is already present in the market?

There are several models of elevators available in the market, but none of them fulfils the wishes and requirements of the industrial automation department of UiT. It is striking that almost all available models have four floors. The following three models are considered in the quality function deployment in chapter 10.

Model A: Feedback 34-150



Figure 2: Model elevator Feedback [6 and 7]

Price: NOK 180 680 (given by supplier)

Features:

- Fully working model of an elevator with four floors
- Floor sensing and visual indication of direction of travel
- Motorised elevator car door
- Normally “on” brake to hold car at desired floor
- Up/ down call buttons on each floor
- Front panel manual switch for testing and debugging
- Integral motor servo controller
- Interfaces with most PLC Types
- Analogue outputs and inputs are also available
- Switchable faults

Technical data:

- Dimensions (packed): width 520 mm x depth 480 mm x height 1110 mm
- Weight: gross 21 kg, net 16 kg

Model B: Dolang Education DLPLC-DT1



Figure 3: Model elevator Dolang Education [8 and 9]

Price: \$ 620 (given by supplier)

Features:

- Lift car, stroke limit mechanism, call light, car gate, control panel, control motor, sensor and drive mechanism. With power failure protection against up/ down and open-close to avoid motor offside running.
- Open closed door control experiment
- Second floor inner select up and down, open and close door control experiment
- Three floor inner select up and down control experiment
- Four floor inner select up and down control
- Three floor outbound up and down control experiment
- Three floor outbound up and down, open and close door control experiment
- Four outbound up and down control experiment
- Three floor elevator comprehensive control experiment
- Four floor elevator comprehensive control experiment, etc. training project.

Technical parameters:

- Total dimension: 380 × 210 × 550 mm
- Input power: single-phase AC 220V±10% 50Hz/60Hz
- Capacity: < 200VA

Model C: Industrial Concepts



Figure 4: Model elevator Industrial Concepts LLC [10]

Price: \$ 2499,99

Features:

- Four-layer elevator model.
- Dragging system with car lifting and car door opening/ closing functions.
- Two DC motors for car lifting and door opening/ closing control, each layer has lift up/ down buttons, the lift car has internal selecting buttons (1-4) and door opening/ closing buttons, the lift way has a travel switch for floor positioning; both sides of the elevator door have a positioning switch.
- Illuminated push button for combined button function with indicator function. The button signal and indicator signal can be controlled separately.
- PLC input signal: Six external calling button signals, four internal selecting button signals, four floor positioning signals, two internal door opening/ closing button signals, two door opening/ closing positioning signals (18 in total).
- PLC output signal: Two lifting control signals, two door opening/ closing control signals, six external calling indicator signals, four arrows indicator signals, four nixie tube floor display signals (18 in total).
- Hardware protection circuit is used to avoid fault caused by offside of motor. The power of lifting motor will be cut off automatically when the car reaches the 1st floor (down) or the 4th floor (up). The door opening/ closing system also has hardware protection functionality.

Technical parameters:

- Power supply: AC 120 V±10% 60Hz
- Ambient humidity: ≤90%
- Dimensions: 600 mm × 450 mm × 260 mm
- Overall power consumption: ≤0.3 kVA

4 Short analysis of former proposals

4.1 Introduction

The assignment to redesign a new model elevator has been given two more times to students of HIN (Høgskolen i Narvik). In 2012 Xiaolan Ma and Zhenru Zhu and in 2015 Iliia Muchkin proposed a model, but both models were not feasible to produce yet.

4.2 Useful and interesting information

Interesting ideas that were mentioned in the proposals were amongst others a shaftless elevator. To create a real-life comparison when practicing with these models, this is however not a very common way to design elevators. For a nice learning experience, it would be good if the models look nice. In the proposals, there was some attention to nice designs. These were however not chosen as the final concept.

4.3 Challenge

The main challenge that can be defined from these proposals is the complexity that was chosen, especially with regard to sliding parts.

5 Function Analysis

The main functionality is defined as: physical simulation of elevator functionality.

Extra features that are defined are:

- Simulation of traffic light (the lights of the buttons on the three different floors can be used for this).
- Simulation of garage door (first floor is closed, second floor is open).

6 Set of requirements

In the following tables, the defined requirements and wishes are summarized.

6.1 Requirements

Table 1: Requirements model elevator

Achievements
Motor: should be able to take up and down the weight of the elevator part
Strength: should withstand some squeezing and horizontal forces when lifting or moving the product
Surroundings
Has to endure rough student use.
The electrical parts need to endure some pulling on the wires.
A spilled cup of coffee on the table should not immediately cause a short circuit.
Lifetime
Several weeks of usage per year in at least 10 years, preferably 20
Maintenance
Should be maintenance free, except for some servicing parts like the motor
Production costs
Cost price maximum 1000 – 1500 NOK
Selling price maximum 2000 – 3000 NOK
Transport
Has to be able to be carried by one person
Packaging
No packaging should be required
Serie size
Estimation: 20 - 30 per year
Production facilities
Preferably available production methods in UiT Narvik (and Solhaugen)
Shape, colour, finishing
A transparent 3D model is preferred
Different colours, shapes, design and finishing can be chosen
For different branding or marketing and user wishes, different designs can be applied
Materials
No nature harming materials should be used
Product life span
10 years
Norms and standards
Ergonomic norms
Ergonomics
Not too heavy (max. 2,5 kg, see size and weight)
Easy to use construction
Usable and serviceable by one person
Size and weight
Maximum weight: 2,5 kilograms; preferably lighter
Maximum size: 55 cm
Minimum size: 35 cm

Reliability/ product liability
Should not be damaged with normal use
Should resist minor impacts
Testing
Fall to the side test: push the product from one side till it falls: no big damage should appear
Scratch test: test scratch resistance of material by scraping it against some sharp edges
Safety
When the electronics cause a short circuit, the user should not get a shock at the outside of the product and no fire should be caused
Product policy
Timeless design, so the product can be used in many years to come
Installation commissioning
One person should be able to use the product

6.2 Wishes

Table 2: Wishes elevator model







































Usage
Learning effect when programmed in a wrong way: make the programmer fix his or her mistake by an activity
Reuse, recycling, waste
It would be nice if all materials could be recycled after its lifetime

7 Ergonomics

In the choice of operation buttons, it needs to be taken into account what operational force is needed in relation to where the button is used. Besides that, the colour of the buttons should be chosen logically. For most buttons this means a neutral colour can be used, but a stop button preferably is red, whereas a start button can be green, but does not need to be. In table 3 on the next page, several different options can be found, including their operational force. (The original tables can be found in appendix 1.) Especially higher up in the elevator, it is likely to tilt, when a too high force is applied to the buttons. Therefore touch keys might be the preferred options. An analysis can be done to check the preferred and maximum value for the operation buttons. Capacitive buttons are a fancy solution, but could be a too expensive option for this project.

The force needed to operate a touch key is zero till 0,5 N, whilst a push button requires 0,5 till 5 N. However, it is known that people usually use more force than needed. According to Jack Tigh Dennerlein, Edward Diao, C. D. Mote Jr. and David M. Rempel, in their article “In Vivo Finger Flexor Tendon Force while Tapping on a Keyswitch”, the average force used on a key switch is 12,9 N with a standard deviation of 3,3 N. [11]

Table 3: Overview of different types of operation buttons including general design guidelines [4]

No	Name	Side view	Top view	Design diameters and global recommended values						
				Move- ment	Diameter/ height, width, length (mm)	Move- ment (degrees/ mm)	Spacing (mm)	Operational force (N)	Number of positions	Possibility visual inspection
1	Touch key			press	13 – 25	0	8 – 13	0 – 0,5	2	+
2	Push button			press	13 – 25	1 – 6 mm	8 – 13	0,5 – 5	2	-
3	Rocker switch			turn	25 – 65 L	30°	8 – 13	1 – 4	2	+/-
4	Thumb wheel			rotate	25 – 65 Ø 5 – 25 W 18 – 25 opening	0° – max.°	13 – 25	0,5 – 2	∞	-
5	Thumb switch			turn	3 – 6 Ø 12 – 20 H	40° - 60°	8 – 15	1 – 5	2 – 3	+
6	Lever switch			Turn	10 – 15	30°	5 – 10	1 – 5	2	+
7	On-off slider			slide	2 – 5 3 – 5 H	6 – 13 mm	15 – 25	0,5 – 2	2	+
8	Continu- ous slide			slide	7 – 10 5 – 10 H	0 – max. mm	20 – 35	0,5 – 4	∞	+
9	Fine-tune rotary knob			rotate	10 – 20	0° – max.°	25 – 50	0 – 0,5	∞	-
10	Multi- position switch			rotate	40 – 60 10 – 30 H	30°	30 – 60	2 – 8	3 – 12	+/-
11	Bar rotary knob			rotate	25 – 50 20 – 30 H	15° – 30°	30 – 60	2 – 8	3 – 6	+
12	Turn knob			rotate	40 – 80 10 – 25 H	0° – max.°	25 – 50	0,5 – 2	∞	-
13	Star rotary knob			rotate	40 – 60 25 – 45 H	0° – max.°	25 – 50	2 – 20	∞	+/-
14	Crank			rotate	20 – 300 radius 30 – 80 H	0° – max.°	60 – 120	10 – 50	∞	-
15	Joystick			press, pull/ push, turn	2 – 5 20 – 200 H	10° – 90°	50 – 100	5 – 50	1 – ∞	+
16	Lever			press, pull/ push	25 – 40 Ø 150 – 600 H 80 – 120 (H hand – foot)	10° – 90°	50 – 100	10 – 100	2 – ∞	+
17	Hand/ arm wheel			rotate	200 – 500 20 – 30 rim Ø	0° – max.°	150 – 300	15 – 150	∞	-
18	Foot push button			press	25 – 90	15 – 70 mm	200 – 500	15 – 70	2	-
19	Pedal			press	100 – 15	50 – 150 mm	50 – 200	15 – 200	2 – ∞	-

8 Morphological overview

In the morphological overview, different solutions for each problem are proposed. For the concepts, different combinations can be chosen.

Table 4: Morphological overview elevator model

	Requirement	Solutions			
1	3 levels	3 building blocks	3 virtual levels (positions defined by a physical line or element)	3 different colours	
2	moving compartment (up – down)	2D plate	3D frame	3D compartment	
3	support of moving compartment	stepped frame	rope (hanging)		
4	power supply	electric motor	hydraulics	air pressure	
5	power supply position	down	up	back	side
6	connection to PLC	banana plugs	fixed plc		
7	visibility of functionality	transparent frame	open frame	open front	light in moving compartment
8	indication of position	position of compartment	(LED) lights on each level	(LED) lights on a general panel	combination of all
9	registration of position	magnet sensor	touch sensor		
10	indication of wished position	(LED) lights on each level	(LED) lights on a general panel	both (LED) lights on each level and on a general panel	none
11	choice of wished position	(push) buttons on each level	(push) buttons on a general panel	both (push) buttons on each level and on a general panel	
12	doors	opening in frame	physical door that opens and closes	extra functionality: registration of open/closed with magnet or touch sensor	no doors
13	shape	squared frame (conventional elevator shape) - squared compartment (2D/ 3D)	Round (cylinder) frame - cylinder compartment	fantasy shape (front) - combined with squared frame and compartment	
14	position(s) electronics (print plate)	print plate in base	print plate at side	print plate at back	no print plate – direct wiring

15	position(s) electronics (buttons/ lights)	on general panel	on each level (side)	both on a general panel and on each level (side)	
16	wiring	through a "pipe" (hidden)	visible as part of the design	each level its own print plate (less wires)	
17	support	base	back frame for attaching on wall		
18	elevator functionality	moving compartment + push buttons and indicator lights			
19	traffic light functionality	3 (LED) lights			
20	garage door functionality	moving compartment	2 (LED) lights		
		A	B	C	D

Combinations:

1. 1B, 2C, 3B, 4A, 5B, 6A, 7A, 8D, 9A, 10C, 11C, 12BC, 13A, 14A, 15C, 16B, 17A, 18A, 19A, 20A (red)
2. 1B, 2C, 3B, 4A, 5B, 6B, 7B, 8D, 9B, 10A, 11A, 12A, 13C, 14B, 15B, 16A, 17A, 18A, 19A, 20A (blue)
3. 1B, 2A, 3B, 4A, 5B, 6A, 7C, 8D, 9A, 10D, 11B, 12D, 13B, 14C, 15A, 16A, 17A, 18A, 19A, 20A (green)

9 Ideas and concepts

From the different combinations in the morphological overview, three general concepts were created. Detailing of the final concept will be done in a later stage. Some ideas can still be integrated in all the different concepts, so they will not be taken into account in the final concept choice, since the concept choice does not depend on them.

9.1 Concept 1

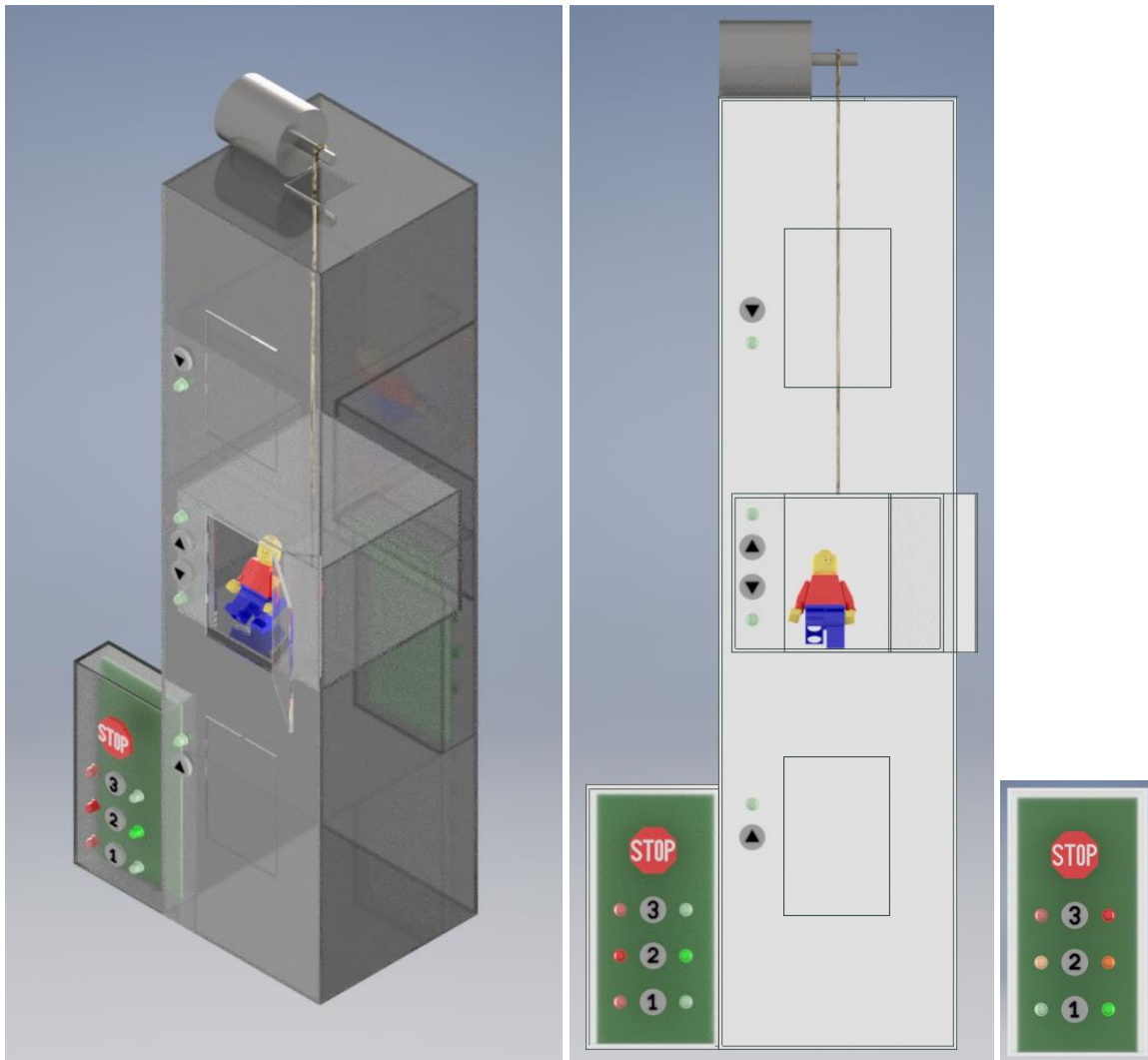

Figure 5: Concept 1 (Inventor)

Concept 1 is an elevator in its most traditional form: a square shaft with a square compartment. The model is made of a transparent material for a good view on where the compartment is located at all times. A panel with stop button, three floor buttons and indication LED's on both sides of the buttons is added. One row of LED's can be used to show which button is pushed, the other can show where the compartment is located. Other colours can be used, for example two red ones on top, two yellow or orange ones in the middle and two green ones in the bottom, then the traffic light function can be used in a more obvious way.

9.2 Concept 2

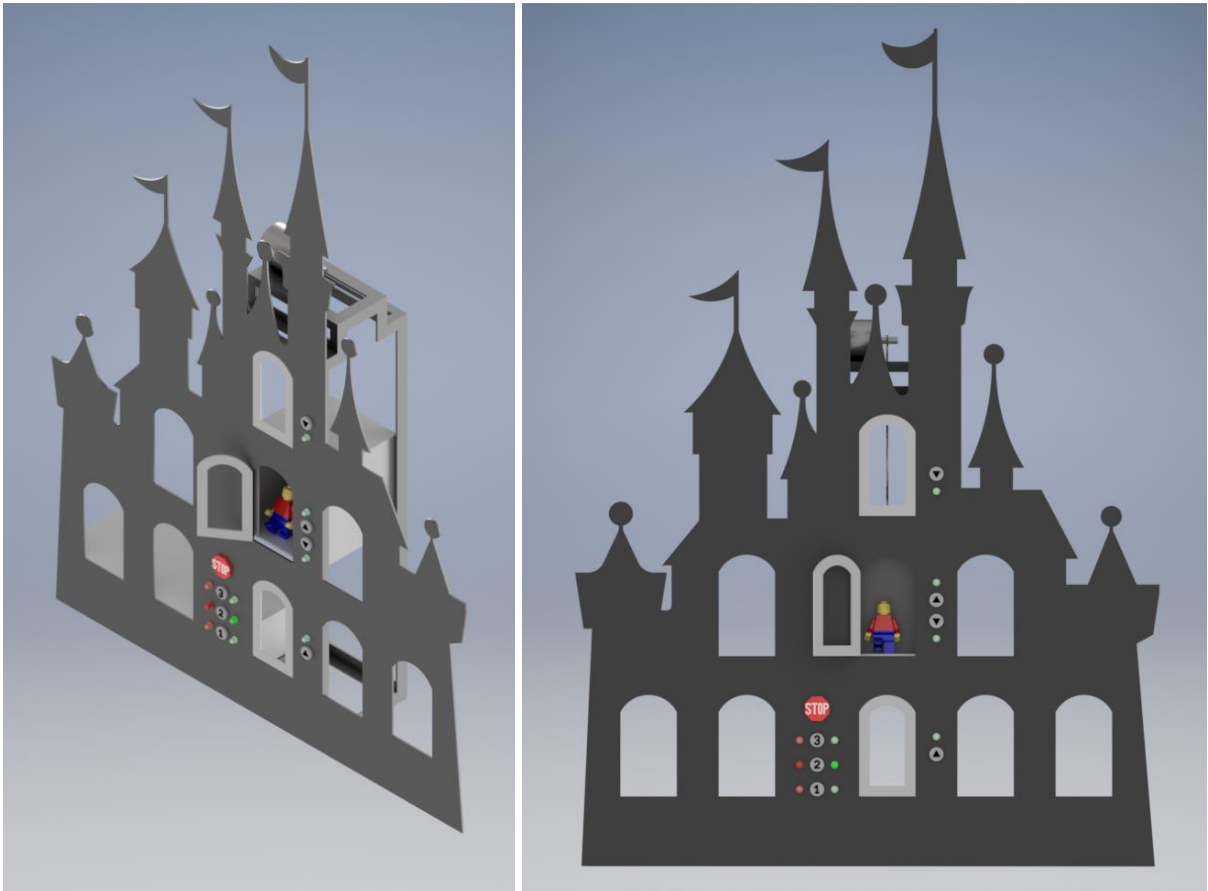

Figure 6: Concept 2 (Inventor)

Concept 2 is not transparent, but has an open structure so it can be seen quite clearly, where the compartment is located. This model has an integrated PLC and no separate panel with buttons; these are integrated in the front panel design. This sketch is based freely upon the Disney Castle, but other shapes can be chosen.

Of course, a fantasy design could also be integrated in concept 1 with a transparent design when wished for by the customer.

9.3 Concept 3

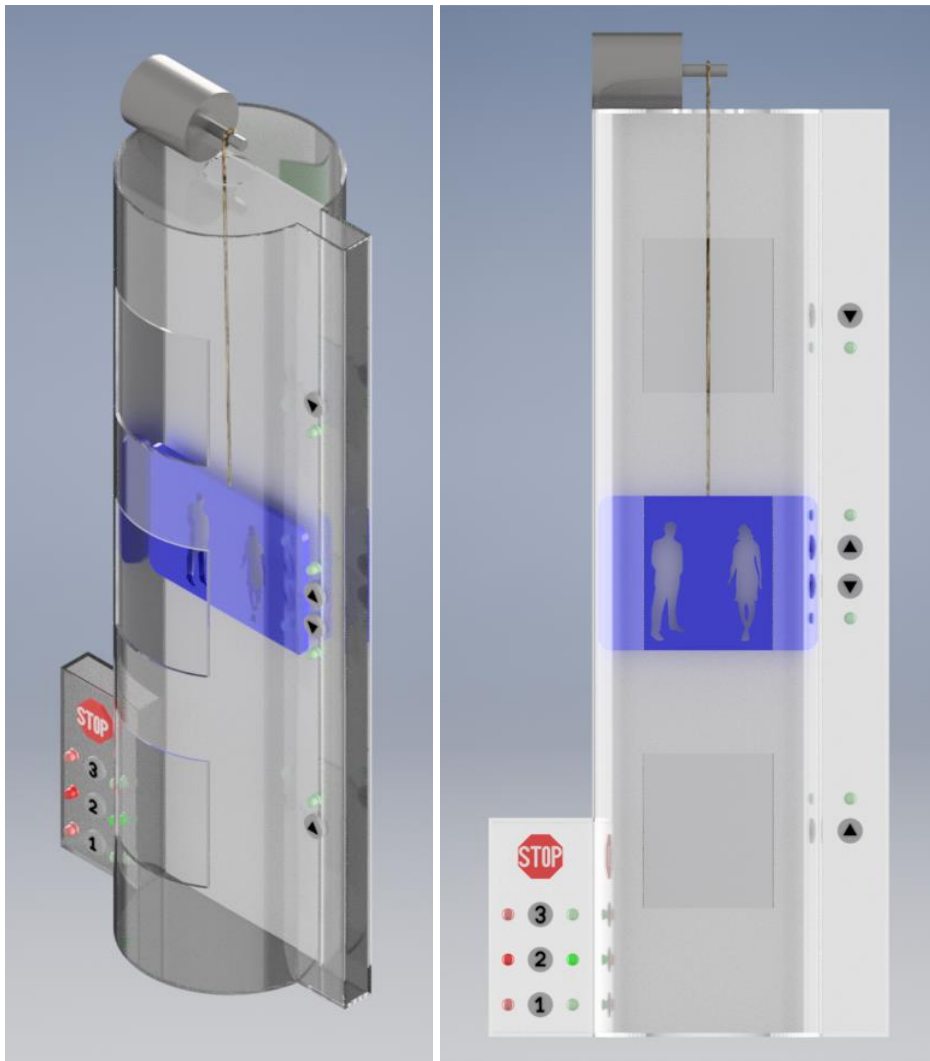

Figure 7: Concept 3 (Inventor)

Concept 3 is based on a circular shape with a 2D compartment instead of 3D. The print plate is hidden in the back and the same panel that divides the space of the tube, prevents the compartment from turning. The compartment can either be made of plastic or metal. The benefit of metal is that it can be registered easier magnetically for the position. In the case of plastic a metal or magnetic strip can be applied.

This design does not really open up for fantasy shapes, but it can be made in different transparent colours to add some attraction for students to use it. The same applies to concept 1.

9.4 Ideas

Some ideas that can be integrated in one or more of the concepts are shown here.

When a squared model is chosen, the design set up can be defined in such a way that the least possible different parts are used. The front will have opening and doors, so this part is always different, but the sides and the back can be made exactly the same. In this case the top and bottom are also the same except for the hole in the top. But maybe a hole in the bottom would be acceptable to easily remove something that falls down. The four sides and bottom could be screwed together while the top can be placed without screws for easy handling when repairs are needed.

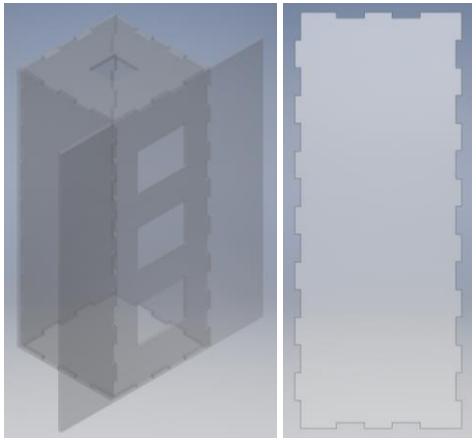

Figure 8: Proposal with the same back and side parts (Inventor)

A stop sign is used in the concepts to show the emergency stop button, but this can also be a normal round button.

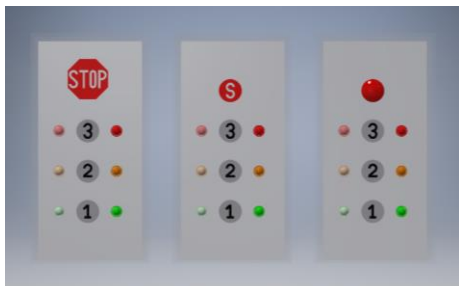

Figure 9: Different proposals for stop buttons (Inventor)

There could be a slightly higher base around the shaft to make a more visible basement where the lift is not supposed to go. This is applicable in concept 1 and 3. This could even be of another colour to hide more of the print plate and wires, except for when the wires are actually wished for as visible in the design.

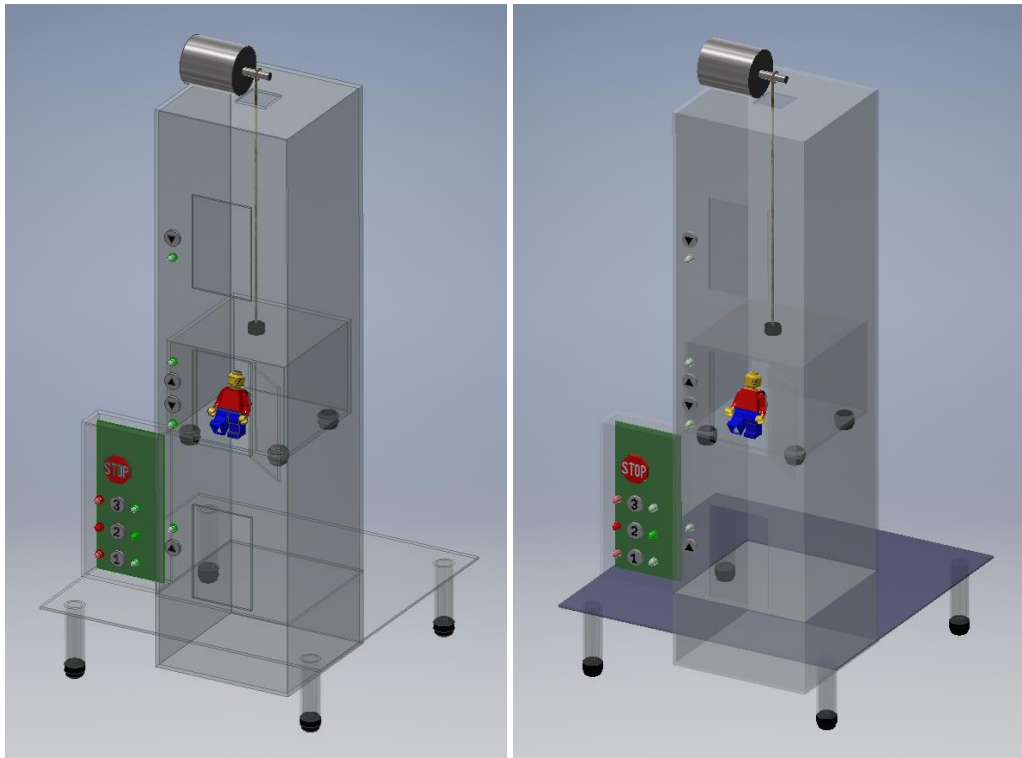

Figure 10: Elevator model with basement and magnet connection between elevator compartment and rope (Inventor)

The elevator compartment could be attached to the rope with a magnet (shown in concept 1 in figure 10, but applicable in all concepts). In this case when it is pulled up too high because of a programming mistake, the compartment will just fall down and can easily be attached again, by sending the magnet down again. This means that there should nothing be in the way for the falling compartment in terms of sensors or connectors, the compartment should have enough strength and rubber legs for example, so they will reduce a little of the blow.

The door could be placed in the elevator compartment instead of three doors on the outside of the shaft.

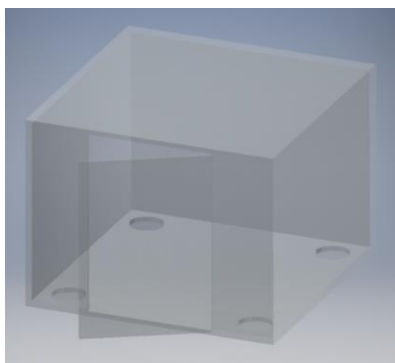

Figure 11: Door in elevator compartment (Inventor)

10 Quality function deployment

Quality function deployment (QFD) is a method for industrial product designers to gain information and insight about which technical parameters are most important in the development or improvement of a product.

First in the left column the most important product parameters are chosen. The technical parameters follow in the top. In the created table then the numbers 1, 3 and 9 are placed to show the relation between the product attributes and the technical parameters; 1 for a weak relation, 3 for an average relation and 9 for a strong relation. In the roof of the QFD-house in the same way the relation between the different technical parameters is indicated. And then the importance of the attributes is chosen. The main functions are ranked from 1 to 5.

In the right column then a product evaluation is done. The benchmark products, the original product and the chosen concepts are compared with each other and a target value is set for the project. This shows which product attributes will need the highest focus in the project and which concept is most likely to fulfil the requirements.

The percentages of these targets are then multiplied with the relation numbers in the table and summarized in the bottom of the left column. Out of the percentages of these, it is possible to find the most important technical parameters. In this case the design is the most important, since it is literally related to almost everything, including user friendliness, like the repair time and usefulness, including different uses of LED lights and the life time, which depends amongst others on the complexity and stability. Other factors that seem to be very important are the complexity and the number of parts. Besides that, the amount and type of controls (and LED indicators) require a large focus in the project, since they are involved in the functionality of the elevator.

A larger version of the QFD-house can be found in appendix 3.

11 Concept choice

From the right column of the QFD-house, it can now be concluded which of the concepts best fits the project. Comparison between the different concepts:

	1	2	3	Total:	Rank:
1		1	1	2	1
2	-1		1	0	2
3	-1	-1		-2	3

The winning concept is concept 1.

12 Final design

In the final design only screws are used as connection method. It can be investigated whether gluing some of the parts would be a feasible option, since this can be cheaper. The disadvantage with that is that the disassembly would become harder and also the servicing of the elevator.



Figure 13: Final design model elevator (Inventor)

On the print plate in the shaft, reed relays are used to detect the magnet in the elevator compartment door. The top of the frame with the motor is not screwed to the frame, for easy servicing and opening. The banana plug connectors are in the back of the panel and in the back of the frame. In case an integrated PLC is preferred after all, this can be positioned under the base on the panel side and then wires could be connected directly to it.

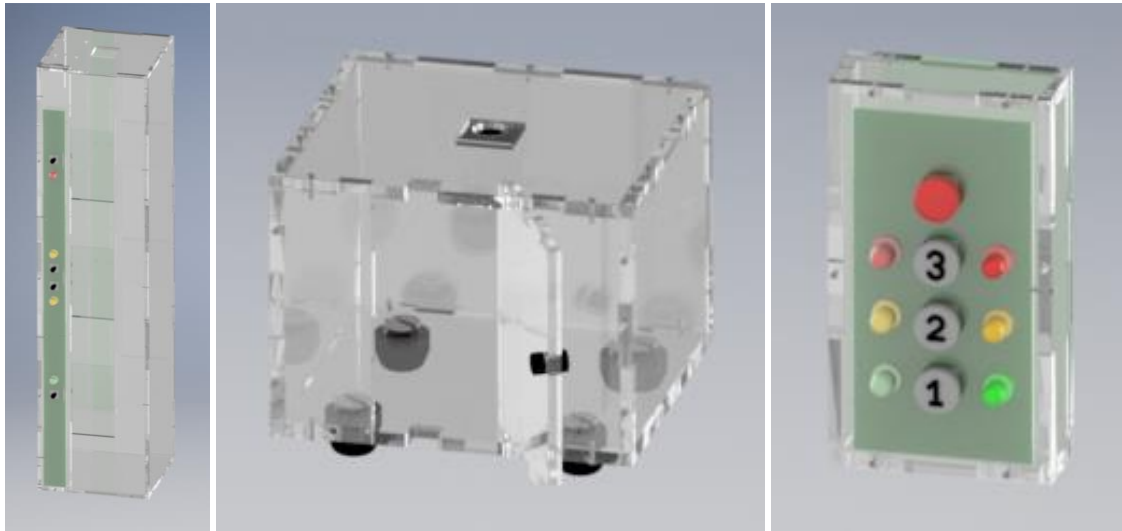

Figure 14: Assembly of the frame, elevator compartment and panel (Inventor)

All transparent parts can be made with a laser cutter.

13 Material selection

First, the design requirements for the material will be defined, containing functions, objectives, constraints and free variables. Then the material will be chosen.

13.1 Defining the design requirements

Functions

What does the component do?

- Providing strength to the whole elevator
- Providing height
- Providing shape
- Protection of the contents (print plates, wires)
- Providing space (for the moving compartment)
- Providing stability to the whole elevator

Objectives

What is to be maximized or minimized?

- The strength needs to be maximized
- The stiffness needs to be maximized
- The durability needs to be maximized
- The surface scratch resistance needs to be maximized
- The weight needs to be minimized
- The costs need to be minimized
- The transparency needs to be maximized

Constraints

What specific requirements must be met?

- No electrical conductivity

Free variables

- Colour
- Finishing
- Material

13.2 Material charts

When all the different objectives are evaluated in charts in several stages in the program CES Edupack 2018, an as optimal as possible material can be found. In the first stage in this project an optimization was done between the Yield strength versus the density, then the same has been repeated in stage 2 with Young's modulus versus the density. Even though it is the intention to use as little material as possible, in stage 3 the most expensive materials were eliminated to avoid excessive prices and in stage 4 it was chosen to just keep the materials that have the possibility to be transparent and recyclable as this were strong wishes. In stage 5 and 6 respectively the material was optimized for its (lack of) electrical conductivity and its scratch resistance (by evaluating its toughness) and its fracture toughness, since the elevator compartment will need to endure some falls.

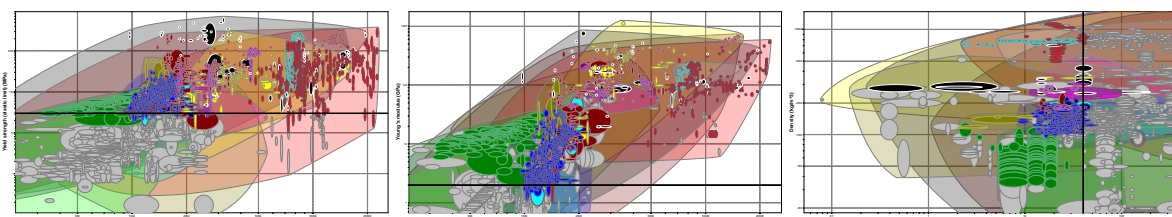

Figure 15: Stages 1-3 in the material choice for the elevator model (CES Edupack 2018)

Each stage leads to fewer materials that still fulfil all requirements and after stage 6, there were only three types of material left that fulfilled all chosen objectives: PMMA, PPC and PS.

13.3 Choice of materials

In this paragraph the information about the materials, was retrieved from CES Edupack 2018 [14]. When the three materials that are left over, are compared with each other (see table 5), all the objectives can be checked one more time. It can be concluded however that the differences are very small. PS has least scratch resistance (amongst others defined by the hardness of the material) and PMMA has the highest, so therefor PMMA or PPC are preferred. PMMA seems to be the strongest and stiffest material, PPC is absolutely the toughest.

Table 5: Material properties (CES Edupack 2018)

	PMMA	PPC	PS
Price [NOK/kg]	21,9 - 22,8	21,1 - 25,8	19,3 - 19,6
Density [kg/m ³]	1,16e3 - 1,22e3	1,19e3 - 1,2e3	1,04e3 - 1,05e3
Young's modulus [GPa]	2,41 - 3,8	2,02 - 2,33	3,1 - 3,34
Yield strength (elastic limit) [MPa]	65,7 - 72,4	63,4 - 66,6	44,4 - 56,2
Shear modulus [Gpa]	0,866 - 1,37	0,719 - 0,839	1,11 - 1,2
Bulk modulus [Gpa]	4,55 - 4,78	3,71 - 3,89	4,79 - 5,03
Hardness - Vickers [HV]	20 - 22	19 - 20	13 - 17
Hardness - Rockwell M	94 - 100	85 - 92	75 - 84
Hardness - Rockwell R	118 - 130	121 - 127	109 - 120
Fracture toughness [MPa,m ^{0,5}]	0,7 - 1,6	3,36 - 3,71	0,7 - 1,1
Toughness (G) [kJ/m ²]	0,18 - 0,761	5,11 - 6,48	0,159 - 0,361
Electrical resistivity [μohm,cm]	3,3e23 - 3e24	2,6e22 - 2,5e23	1e25 - 1e27
Electrical conductivity [%IACS]	5,75e-23 - 5,22e-22	6,9e-22 - 6,63e-21	1,72e-25 - 1,72e-23

Another option would then be to look at the processing energy and the CO₂ footprint of the materials (see table 6). Also here the differences are small, but since there is a huge margin on the material properties with respect to the requirements, it is very relevant to take into account its influence on the environment. There is not just one material that comes out as a winner. PPC wins HV when it comes to processing energy, but is worst in its initial CO₂ footprint.

Table 6: Processing energy and CO₂ footprint (CES Edupack 2018)

	PMMA	PPC	PS
Coarse machining energy (per unit wt removed) [MJ/kg]	1,23 - 1,36	1,09 - 1,21	1,32 - 1,46
Coarse machining CO2 (per unit wt removed) [kg/kg]	0,0926 - 0,102	0,0821 - 0,0907	0,099 - 0,109
Fine machining energy (per unit wt removed) [MJ/kg]	8,07 - 8,92	6,67 - 7,37	8,93 - 9,87
Fine machining CO2 (per unit wt removed) [kg/kg]	0,605 - 0,669	0,5 - 0,553	0,67 - 0,74
CO2 footprint, primary production [kg/kg]	4,64 - 5,11	5,49 - 6,05	2,4 - 2,64

Final choice

All these considerations taken into account, the final material choice is PMMA.

14 Calculations

Mainly two things need to be checked: first of all the strength of the parts, and secondly, the whole model should not tilt when the buttons are pushed. Both these issues were checked with an analysis in Ansys. The second one has been confirmed by an analysis in SolidWorks as well.

The part that will endure the most, is the elevator compartment which is subject to fall every time a student programs wrongly and sends the elevator up too high. Therefore the impact of the fall was simulated by an impact force on the legs of the compartment.

All results were well within range of the chosen materials, which was to be expected with a slightly over dimensioned product.

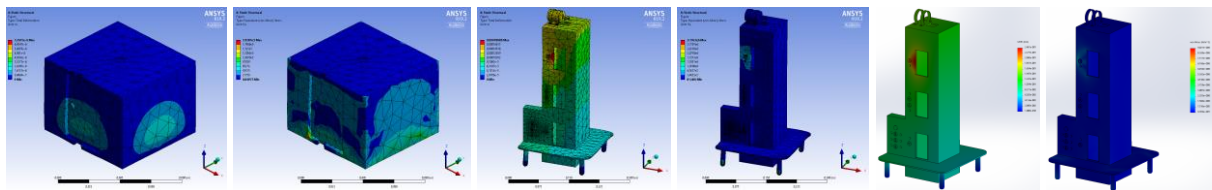

Figure 16: Displacement and maximum stress of elevator compartment (Ansys) and frame (Ansys and SolidWorks)

The maximum deformation is calculated to be around 0,2 mm by both Ansys and SolidWorks. The maximum stress is calculated to be 3,1 MPa.

Different types of PMMA have slightly different values on the material properties. The material used in Ansys has the properties following in table 7.

Table 7: Material properties PMMA (Ansys)

Density [kg/m ³]	1180
Young's modulus [Pa]	2,69e9
Bulk modulus [Pa]	4,2698e9
Shear modulus [Pa]	9,6416e8

15 Cost price

An estimation of the cost price is calculated. It is expected that the costs are around 2000 NOK, which is well in range with the predefined requirements. A number of websites were used for calculation of the prices and can be found in appendix 5; these websites are not mentioned separately again in the website list of used sources.

Table 8: Cost price calculation elevator model

all prices in NOK

Parts:	Size:	Number:	Price per piece:	Total:
Frame front	90x360x3 [mm]	1	16	16
Frame back and right side	90x360x3 [mm]	2	16	32
Frame left side	90x360x3 [mm]	1	16	16
Frame top	90x90x3 [mm]	1	12	12
Frame bottom	90x90x3 [mm]	1	12	12
Frame print plate protection	25x360x3 [mm]	1	14	14
Elevator compartment back	80x60x3 [mm]	1	12	12
Elevator compartment front	22,5x60x3 [mm]	2	10	20
Elevator compartment side	75x60x3 [mm]	2	12	24
Elevator compartment top	80x75x3 [mm]	1	12	12
Elevator compartment bottom	80x75x3 [mm]	1	12	12
Elevator compartment door	37,5x60x3 [mm]	1	10	10
Panel front	50x90x3 [mm]	1	12	12
Panel back	50x90x3 [mm]	1	12	12
Panel side	20x90x3 [mm]	2	10	20
Panel top and bottom	50x20x3 [mm]	2	10	20
Base	190x190x3 [mm]	1	14	14
Pipe	Ø12x2 x 37,5 [mm]	4	39,5/m	4,83
Rubber feet		8	1,2	9,6
Print plate frame	320x18 [mm]	1	42	42
Print plate panel	80x40 [mm]	1	48	48
LED green		3	2,39	7,17
LED yellow		4	1,89	7,56
LED red		5	2,89	14,45
Tactile switch		8	1,15	9,2
Reed relay		3	7,18	21,54
Wires		25	8,74/m	2,19
Red stop button	Ø10 [mm]	1	3	3
Number one button	Ø10 [mm]	1	3	3
Number two button	Ø10 [mm]	1	3	3
Number three button	Ø10 [mm]	1	3	3
Arrow button	Ø10 [mm]	4	3	12
Banana plug connectors		25	1,185	29,63

Countersunk head screw	M1x0,2 x 6	86	1,49	128,1
Countersunk head screw	M3x0,5 x 6	4	2,24	8,96
Countersunk head screw	M4x0,7 x 10	4	1,91	7,64
Countersunk head screw	M4x0,7 x 45	4	2,86	11,44
Nut	M3	4	0,449	1,796
Magnet elevator door	∅5x7,5 [mm]	1	3,3	3,3
Magnet elevator top	12,5x12,5x2,5 [mm]	1	3,6	3,6
Magnet rope	∅7,5x5 [mm]	1	3,3	3,3
Rope		1	2,2/40m	0,02
Motor		1	272	272
Motor clamps		1	15,4	15,4

Subtotal: 947

<u>Manufacturing and processing:</u>	<u>Number of hours:</u>	<u>Price per hour:</u>	<u>Total:</u>
Laser cutter	0,24	350	84
Tapping holes	0,72	350	252

Subtotal: 336

<u>Assembly:</u>	<u>Number of hours:</u>	<u>Price per hour:</u>	<u>Total:</u>
	2	350	700

Subtotal: 700

Total: 1983

Note: machine costs and manufacturing and processing costs are converted to an amount of hours, this means a factor has been applied to the real amount of hours to cover these costs

	<u>Number:</u>	<u>Price per piece:</u>	<u>Total:</u>
Optional: Lego man	1	27,9	<u>2011</u>

16 Conclusion and continuation

The model can now be produced and in cooperation with the automation department of UiT in Narvik, it can be decided whether more iteration loops are needed later on, when it comes to series production. A small company can be set up to produce the models for the students of UiT and it can be investigated whether other schools are also interested in ordering the models.

Sources

Books

- [1] Ashby, Michael F., *Materials Selection in Mechanical Design, fourth edition*, Elsevier, 2011
- [2] Ashby, Michael; Shercliff, Hugh; Cebon, David; *Materials, engineering, science, processing and design*, Elsevier, 2007
- [3] Cross, Nigel, *Engineering design methods, strategies for product design, third edition*, Wiley, 2005
- [4] Dirken, Hans, *Productergonomie, ontwerpen voor gebruikers*, Delft University press (The Netherlands), 1999
- [5] Roozenburg, N.F.M. and Eekels, J., *Productontwerpen, structuur en methoden*, Uitgeverij Lemma BV, Utrecht (The Netherlands), 2001

Webistes

- [6] <https://www.leybold-shop.com/elevator-plc-application-34-150-1.html>
- [7] http://catalogue.techno-test.com/produits/6-Educational_Products/1185-34_150_1-34_150_1_Elevator_PLC_Application.html
- [8] <http://www.dolangeducation.com/plc-training-series/718.html>
- [9] <http://plctrainerkit.blogspot.com/2017/02/elevator-trainer-teaching-model-with.html>
- [10] <https://www.plccable.com/miniature-machine-ultimate-plc-trainer-elevator-electrical-training-plc-controlled/>
- [11] <https://onlinelibrary.wiley.com/doi/abs/10.1002/jor.1100170205>

Documents

- [12] 2017.11 - Alex Stikkord Heis.doc
- [13] 99 - Heis A3 laminert.doc

Programs

[14] CES Edupack 2018

[15] Autodesk Inventor

[16] Ansys 19.2

[17] SolidWorks

[18] Syswin 3.4

Appendix 1: Overview operation buttons

no./naam	schema		inzet	beweging
	zij-aanzicht	boven-aanzicht		
1. tiptoets			1	d
2. drukknop			1/2	d
3. wipchakelaar			2	z
4. duimwiel			2	r
5. tuimelschakelaar			2/3	z
6. hefboomschakelaar			2/3	z
7. aan - uit schuif			3	s
8. continu schuif			3	s
9. fijnsteldraaiknop			3	r
10. meerstandenschakelaar			4	r
11. staafdraaiknop			4	r
12. draaischijf			4/5	r
13. sterdraaiknop			5	r
14. zwengel			6/7	r
15. joystick			6/7	d t z
16. hendel			7	d t
17. hand/armwiel			7/8	r
18. voetdrukknop			9/10/11	d
19. pedaal			9/10/11	d

Figuur 10.1 Overzicht van typen hand- en voetbedieningsmiddelen, gerangordend volgens de inzet van de ledenketting.

inzet:		beweging:	
1 = vingertop	7 = arm	d = drukken	
2 = vinger	8 = armen, met romp	t = trekken/duwen	
3 = wijsvinger + duim	9 = voet vanuit enkel	r = roteren	
4 = vingers, + of - duim	10 = been vanuit knie	z = zwenken	
5 = hand	11 = been vanuit bekken	s = schuiven	
6 = onderarm			

Figure 17: Overview of different types of operation buttons including general design guidelines [4]

no.	naam	ontwerpparameters en globale advieswaarden						
		diameter breed, lang (mm)	hoog. (mm)	beweging (graden, mm)	tussen-ruimte (mm)	operationele kracht (N)	aantal standen	mogelijkheid visuele controle
1	tiptoets	13 - 25		0	8 - 13	0 - 0,5	2	+
2	drukknop	13 - 25		1 - 6 mm	8 - 13	0,5 - 5	2	-
3	wipchakelaar	25 - 65 L		30°	8 - 13	1 - 4	2	+/-
4	duimwiel	25 - 36 Ø		0 - max.°	13 - 25	0,5 - 2	∞	-
		5 - 25 B						
		18 - 25 opening						
5	tuimelschakelaar	3 - 6 Ø		40 - 60°	8 - 15	1 - 5	2 - 3	+
		12 - 20 H						
6	hefboom-schakelaar	10 - 15		30°	5 - 10	1 - 5	2	+
7	aan - uit schuif	2 - 5		6 - 13 mm	15 - 25	0,5 - 2	2	+
		3 - 5 H						
8	continu schuif	7 - 10		0 - max. mm	20 - 35	0,5 - 4	∞	+
		5 - 10 H						
9	fijnsteldraaiknop	10 - 20		0 - max.°	25 - 50	0 - 0,5	∞	-
10	meerstandenschakelaar	40 - 60		30°	30 - 60	2 - 8	3 - 12	+/-
		10 - 30 H						
11	staafdraaiknop	25 - 50		15 - 30°	30 - 60	2 - 8	3 - 6	+
		20 - 30 H						
12	draaischijf	40 - 80		0 - max.°	25 - 50	0,5 - 2	∞	-
		10 - 25 H						
13	sterdraaiknop	40 - 60		0 - max.°	25 - 50	2 - 20	∞	+/-
		25 - 45 H						
14	zwengel	20 - 300 straal		0 - max.°	60 - 120	10 - 50	∞	-
		30 - 80 H						
15	joystick	2 - 5		10 - 90°	50 - 100	5 - 50	1 - ∞	+
		50 - 200 H						
16	hendel	25 - 40 Ø		10 - 90°	50 - 100	10 - 200	2 - ∞	+
		150 - 600 H						
		80 - 120 (H. hand-voet)						
17	hand/armwiel	200 - 500		0 - max.°	150 - 300	15 - 150	∞	-
		20 - 30 velg Ø						
18	voetdrukknop	25 - 90		15 - 70 mm	200 - 500	15 - 70	2	-
19	pedaal	100 - 150		50 - 150 mm	50 - 200	15 - 200	2 - ∞	-

Figuur 10.2 Algemene richtlijnen voor de uitvoering van de verschillende typen van hand- en voetbedieningsmiddelen.

Appendix 2: Elevator model for Programmable Logic Controller

Heismodell for Programmerbare Logiske Styringer

Heiskupéen er representert ved en akrylplate som glir i føringene inne i et akrylrør.

Heismotoren har gir, og ved levering er dette innstilt på 1:60. Motoren har permanente magneter, og reversering skjer ved å bytte polaritet på ankeret. Dessuten har motoren en vender på toppen hvor en kan snu dreieretningen. Venderen har også en midtstilling hvor strømmen til motoren er brutt. Ved programmeringsfeil er denne nyttig som nødstopp. Motoren tåler 6 volt, men 3 volt gir passe hastighet for sikker drift. Spenning tilføres nr. 16 og 17 på kontaktlisten.

Innganger til PLS er trykknapper og tørre reedkontakter. Dessuten kan «Ledig/ Opptatt» simuleres med en vender på koblingslisten bak modellen. Reedkontaktene har to oppgaver. Den ene er å kontrollere at dørene er lukket, og den andre er å varsle når kupéen kommer til oppkalt etasje. I tillegg er kontakter plassert i bunn og topp som nødstopper. Kontaktene opereres av permanentmagneter.

Utganger fra PLS opererer tre typer komponenter:

Reléer for heismotor, «Kjør Opp» og «Kjør Ned»
Lysdioder, brukt som lamper
Akustisk signal

For å beskytte utgangene mot feilkobling, er det satt inn en diode i fellesledningen (20).

Lampe «Alarm» kan programmeres på tid. Hvis kupéen bruker for lang tid mellom to etasjer, kan alarmen virke automatisk. Akustisk signal (23) kan programmeres til å gi et kort «støt» ved kupéens ankomst til etasje. Den kan også virke sammen med den optiske alarm.

Alle utganger er dimensjonert for 24 volt likespenning.

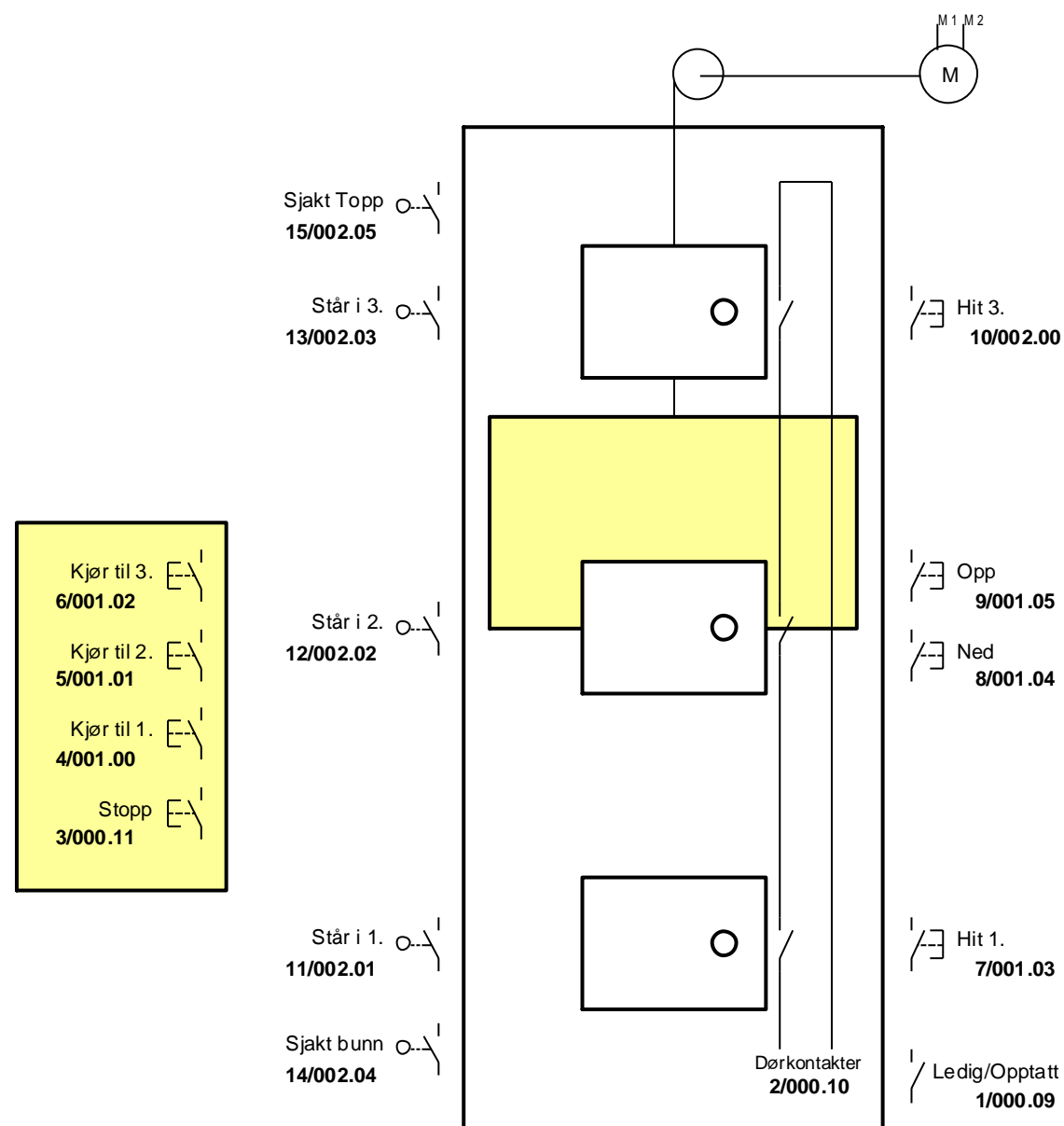

Oversikt over innganger til PLS

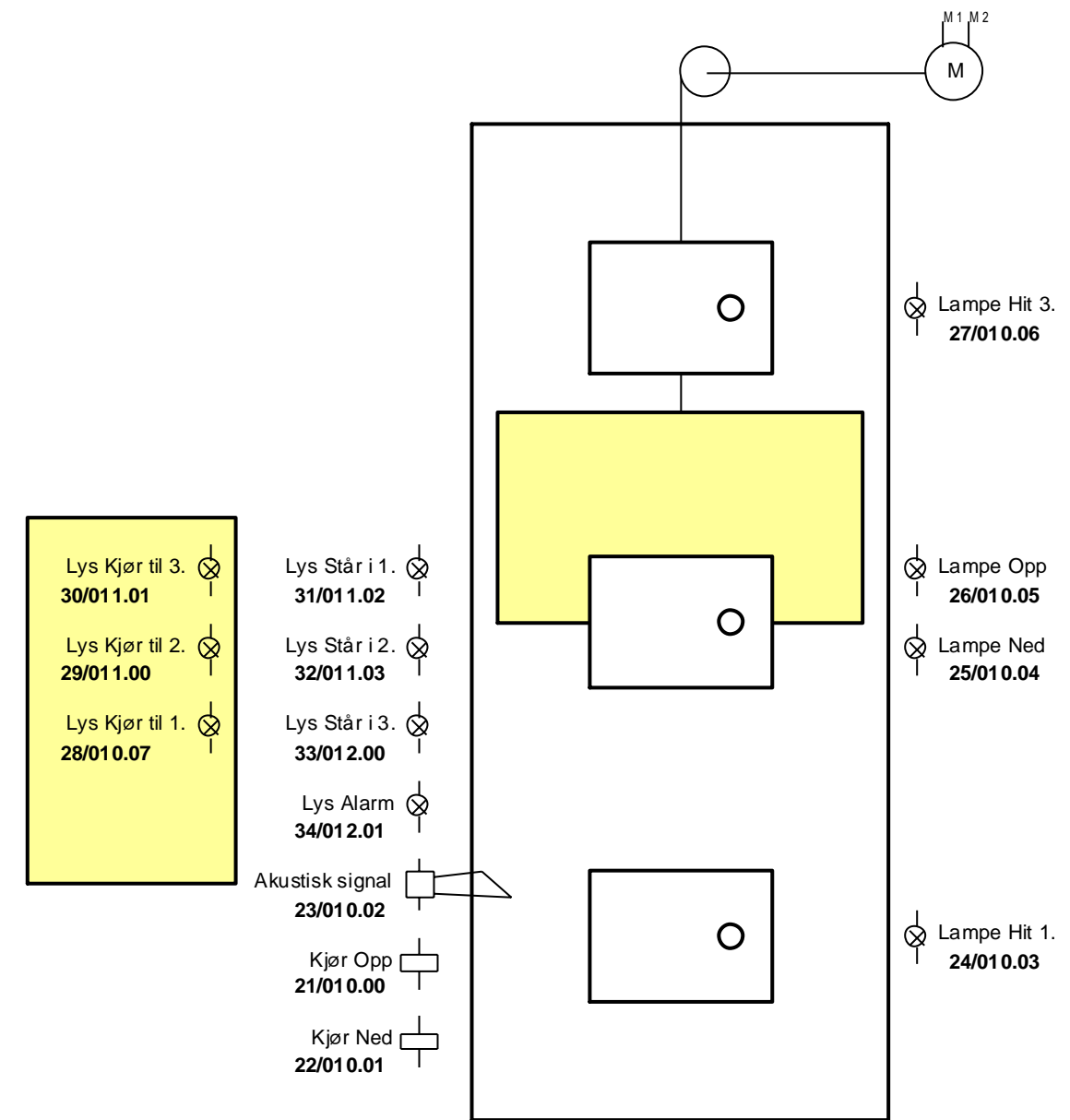

Oversikt over utganger fra PLS

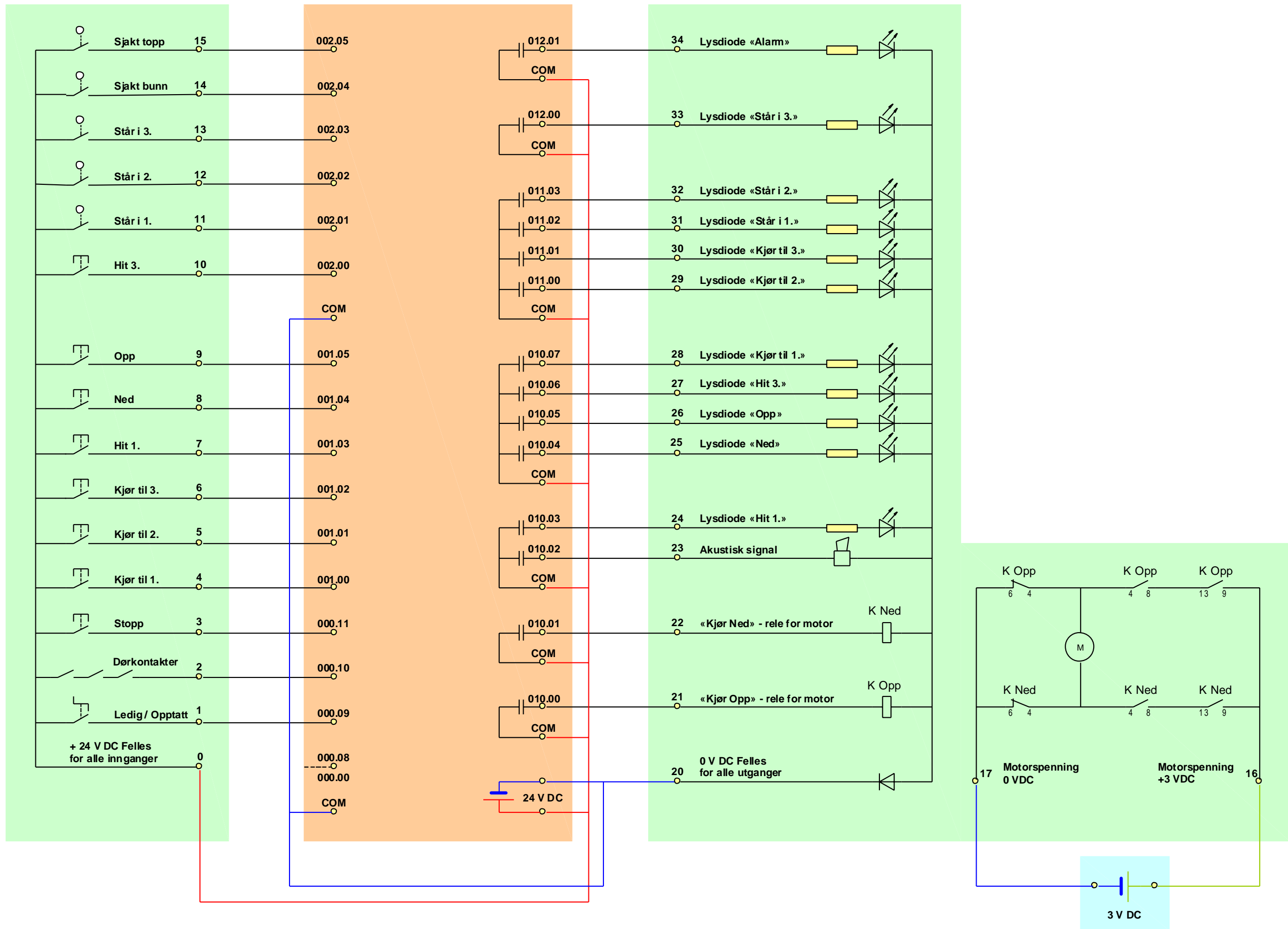
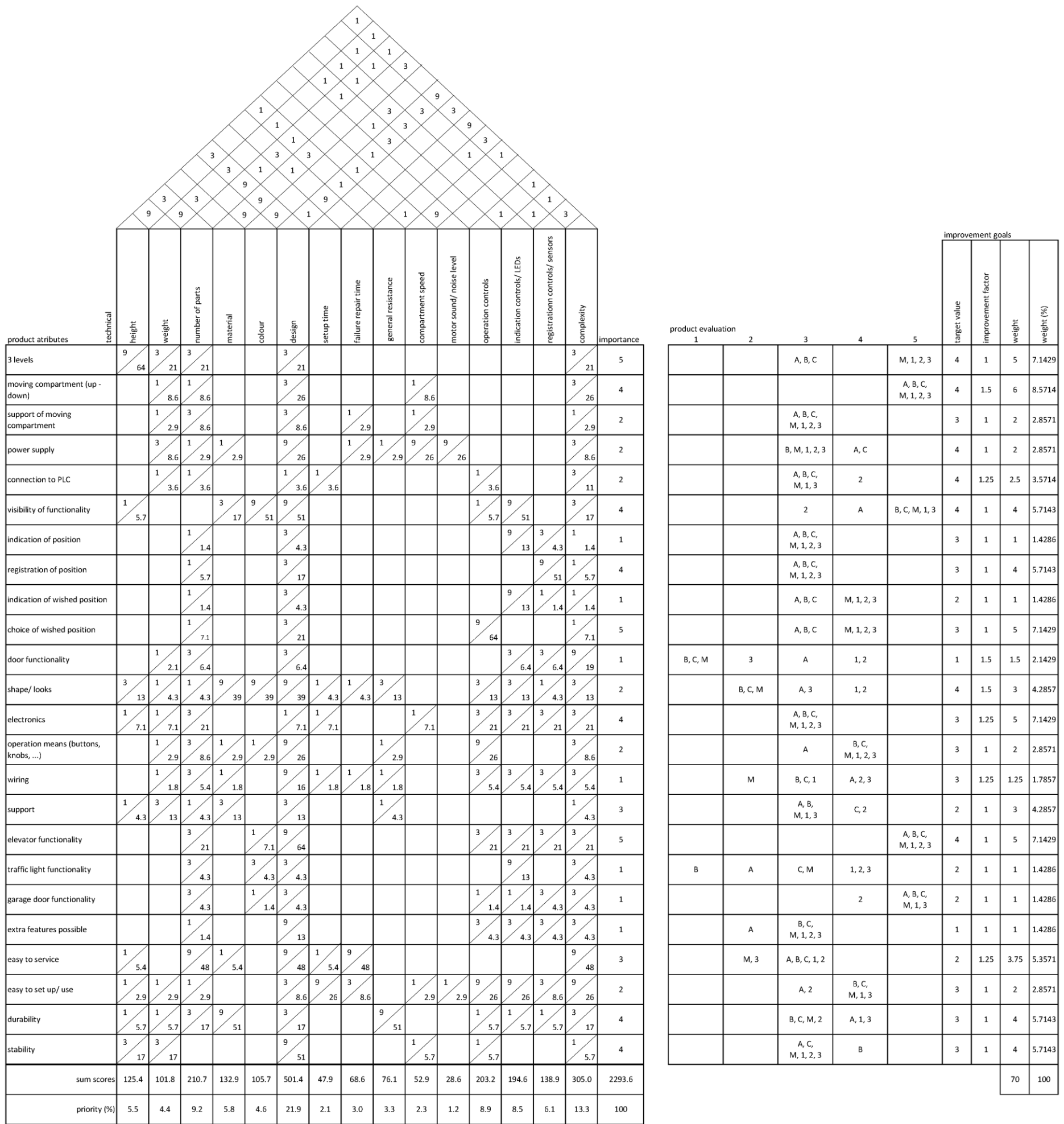

Figure 19: Overview of the connections [13]

Appendix 3: QFD-house A3



measure unit	cm	kg	#	type	type	type	# mi- minutes	# mi- minutes	x	cm/s or rpm	dB(A)	type and #	type and #	type and #	x
our product	46	2,66	medium	depending on design	transparent	transparent shaft	5	5 - 15	good	10 cm/s - adjust-tablet	55 - 65	both on panel and each level	both on panel and each level	magnet sensor	simple/medium
competitor products	55 - 111	mostly higher than 5, up to 20	medium	depending on design	depending on design	depending on design	5 - 15	depending on design	good	depending on design	depending on design	depending on design	depending on design	depending on design	simple/medium
target value	min. 35 - max. 55	2,5 (excl. PLC)	small - medium	depending on design	transparent	transparent shaft	5	5	good	10 cm/s	max. 60	both on panel and each level	both on panel and each level	magnet sensor	simple

A = Model elevator Feedback
 B = Model elevator Dolang Education DLPLC-DT1
 C = Model elevator Industrial Concepts LLC
 M = Current model
 1 = concept 1
 2 = concept 2
 3 = concept 3

Figure 20: QFD-house model elevator

Appendix 4: PLS program for model elevator (created in Syswin)

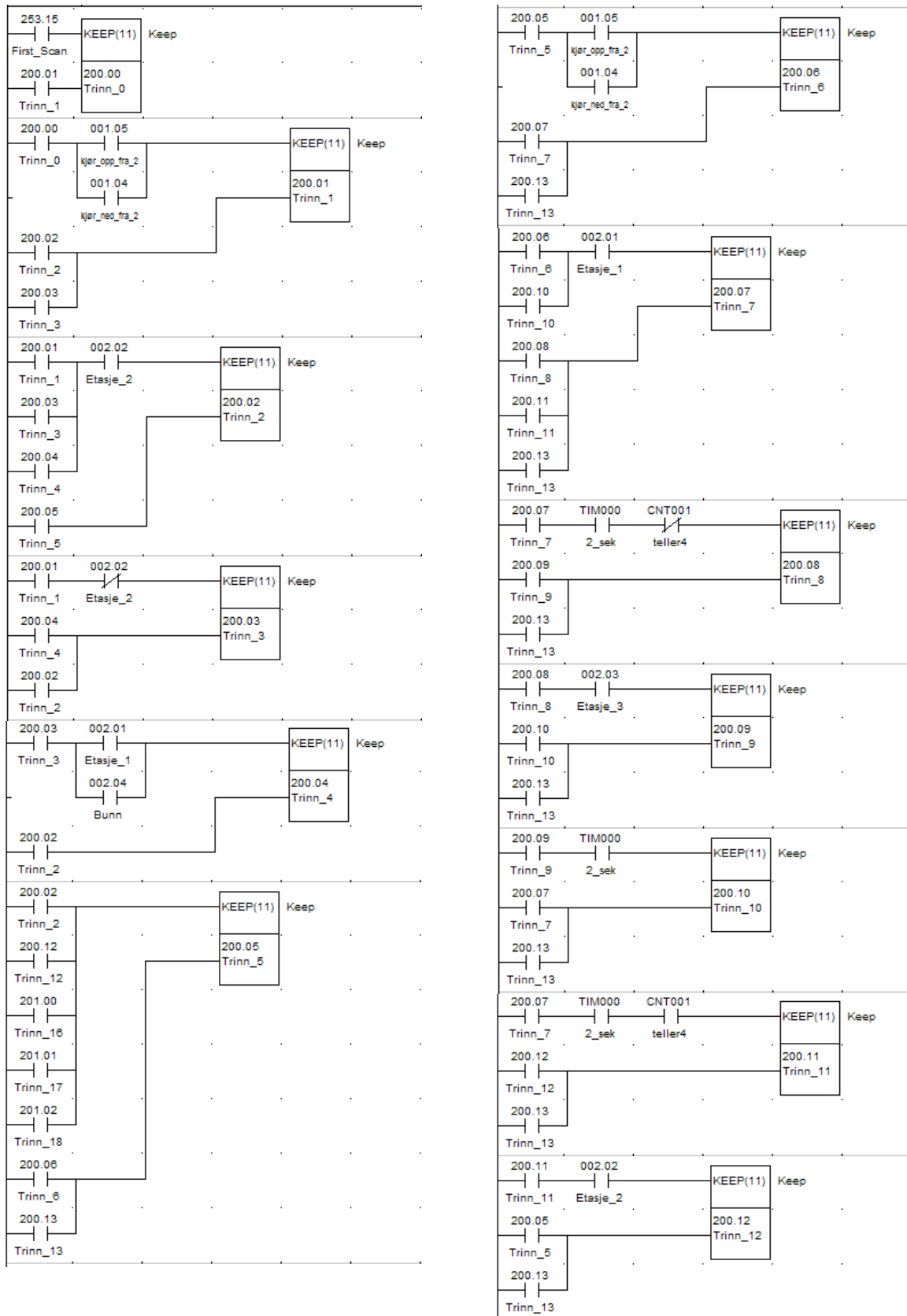

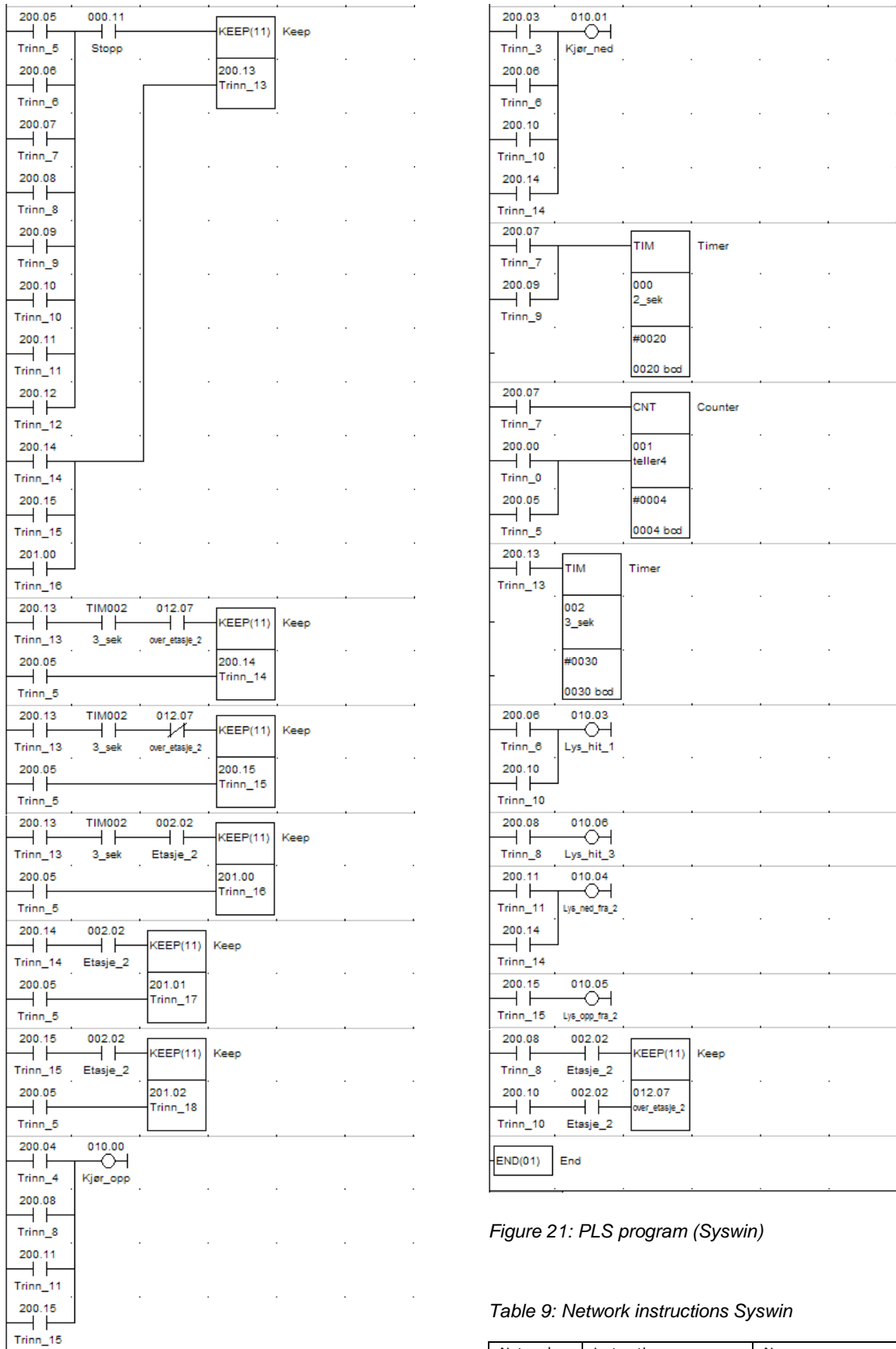

Figure 21: PLS program (Syswin)

Table 9: Network instructions Syswin

Network	Instructions	Name
1	LD 253.15	First_Scan
	LD 200.01	Trinn_1
	KEEP 200.00	Trinn_0

2	LD 200.00 LD 001.05 OR 001.04 AND LD LD 200.02 OR 200.03 KEEP 200.01	Trinn_0 kjør_opp_fra_2 kjør_ned_fra_2 Trinn_2 Trinn_3 Trinn_1
3	LD 200.01 OR 200.03 OR 200.04 AND 002.02 LD 200.05 KEEP 200.02	Trinn_1 Trinn_3 Trinn_4 Etasje_2 Trinn_5 Trinn_2
4	LD 200.01 AND NOT 002.02 LD 200.04 OR 200.02 KEEP 200.03	Trinn_1 Etasje_2 Trinn_4 Trinn_2 Trinn_3
5	LD 200.03 LD 002.01 OR 002.04 AND LD LD 200.02 KEEP 200.04	Trinn_3 Etasje_1 Bunn Trinn_2 Trinn_4
6	LD 200.02 OR 200.12 OR 201.00 OR 201.01 OR 201.02 LD 200.06 OR 200.13 KEEP 200.05	Trinn_2 Trinn_12 Trinn_16 Trinn_17 Trinn_18 Trinn_6 Trinn_13 Trinn_5
7	LD 200.05 LD 001.05 OR 001.04 AND LD LD 200.07 OR 200.13 KEEP 200.06	Trinn_5 kjør_opp_fra_2 kjør_ned_fra_2 Trinn_7 Trinn_13 Trinn_6
8	LD 200.06 OR 200.10 AND 002.01 LD 200.08 OR 200.11 OR 200.13 KEEP 200.07	Trinn_6 Trinn_10 Etasje_1 Trinn_8 Trinn_11 Trinn_13 Trinn_7
9	LD 200.07 AND TIM000 AND NOT CNT001 LD 200.09 OR 200.13 KEEP 200.08	Trinn_7 2_sek teller4 Trinn_9 Trinn_13 Trinn_8
10	LD 200.08 AND 002.03 LD 200.10 OR 200.13 KEEP 200.09	Trinn_8 Etasje_3 Trinn_10 Trinn_13 Trinn_9
11	LD 200.09 AND TIM000 LD 200.07 OR 200.13 KEEP 200.10	Trinn_9 2_sek Trinn_7 Trinn_13 Trinn_10
12	LD 200.07 AND TIM000 AND CNT001 LD 200.12 OR 200.13 KEEP 200.11	Trinn_7 2_sek teller4 Trinn_12 Trinn_13 Trinn_11
13	LD 200.11 AND 002.02 LD 200.05 OR 200.13 KEEP 200.12	Trinn_11 Etasje_2 Trinn_5 Trinn_13 Trinn_12

14	LD 200.05 OR 200.06 OR 200.07 OR 200.08 OR 200.09 OR 200.10 OR 200.11 OR 200.12 AND 000.11 LD 200.14 OR 200.15 OR 201.00 KEEP 200.13	Trinn_5 Trinn_6 Trinn_7 Trinn_8 Trinn_9 Trinn_10 Trinn_11 Trinn_12 Stopp Trinn_14 Trinn_15 Trinn_16 Trinn_13
15	LD 200.13 AND TIM002 AND 012.07 LD 200.05 KEEP 200.14	Trinn_13 3_sek over_etasje_2 Trinn_5 Trinn_14
16	LD 200.13 AND TIM002 AND NOT 012.07 LD 200.05 KEEP 200.15	Trinn_13 3_sek over_etasje_2 Trinn_5 Trinn_15
17	LD 200.13 AND TIM002 AND 002.02 LD 200.05 KEEP 201.00	Trinn_13 3_sek Etasje_2 Trinn_5 Trinn_16
18	LD 200.14 AND 002.02 LD 200.05 KEEP 201.01	Trinn_14 Etasje_2 Trinn_5 Trinn_17
19	LD 200.15 AND 002.02 LD 200.05 KEEP 201.02	Trinn_15 Etasje_2 Trinn_5 Trinn_18
20	LD 200.04 OR 200.08 OR 200.11 OR 200.15 OUT 010.00	Trinn_4 Trinn_8 Trinn_11 Trinn_15 Kjør_opp
21	LD 200.03 OR 200.06 OR 200.10 OR 200.14 OUT 010.01	Trinn_3 Trinn_6 Trinn_10 Trinn_14 Kjør_ned
22	LD 200.07 OR 200.09 TIM 000 #0020	Trinn_7 Trinn_9 2_sek
23	LD 200.07 LD 200.00 OR 200.05 CNT 001 #0004	Trinn_7 Trinn_0 Trinn_5 teller4
24	LD 200.13 TIM 002 #0030	Trinn_13 3_sek
25	LD 200.06 OR 200.10 OUT 010.03	Trinn_6 Trinn_10 Lys_hit_1
26	LD 200.08 OUT 010.06	Trinn_8 Lys_hit_3
27	LD 200.11 OR 200.14 OUT 010.04	Trinn_11 Trinn_14 Lys_ned_fra_2
28	LD 200.15 OUT 010.05	Trinn_15 Lys_opp_fra_2
29	LD 200.08 AND 002.02 LD 200.10 AND 002.02 KEEP 012.07	Trinn_8 Etasje_2 Trinn_10 Etasje_2 over_etasje_2
30	END	

Appendix 5: Cost price calculation

Table 10: Cost price calculation information

Part:	Websites & information:
Frame front, Frame back and right side, Frame left side, Frame top, Frame bottom, Frame print plate protection, Elevator compartment back, Elevator compartment front, Elevator compartment side, Elevator compartment top, Elevator compartment bottom, Elevator compartment door, Panel front, Panel back, Panel side, Panel top and bottom, Base	<p>https://plexiglasstunter.nl/plexiglas-xt-glashelder-plaat Price per square meter: €123,75</p> <p>https://plexiglasstunter.nl/goedkoopste-plexiglas-xt-plaat-glashelder Price per piece: €1,-</p> <p>In the cost price calculation slightly higher prices than 1 euro are taken into account, due to square meter price.</p>
Pipe	<p>https://www.pvc24.nl/kopen/transparante-pvc-buizen/12mm-transparante-pvc-buis/ Price per 100 cm: €3,26</p>
Rubber feet	https://www.ebay.co.uk/p/Furniture-Non-slip-Tapered-Rubber-Foot-Washer-22mm-X-10mm-12-Pcs-V-K3v4/2070435783?iid=222186564115
LED green, LED yellow, LED red	https://www.elfadistrelec.no/en/optoelectronics/leds/leds-through-hole/through-hole-leds-single-colour/c/cat-DNAV_PL_020103?q=*&filter_Buyable=1&filter_Category4=Through+Hole+LEDs+-+Single+Colour&filter_Category3=LEDs+-+Through+Hole&pageSize=100&sort=Bulb+Size+%28Diameter%29~m%3Adesc&scroll=862
Tactile switch	https://www.elfadistrelec.no/en/switches-relays/switches/tactile-switches/c/cat-DNAV_PL_050115?sort=Price%3Aasc
Reed relay	https://www.elfadistrelec.no/en/switches-relays/relays/reed-relays/c/cat-DNAV_PL_050207?q=*&filter_Buyable=1&filter_Category3=Reed+Relays&pageSize=100&sort=Price%3Aasc
Wires	https://www.amazon.com/Electronix-Express-Hook-Wire-Solid/dp/B00B4ZRPEY?ref=Oct_BSellerC_495310_6&pf_rd_p=7d87df11-afce-5e10-8550-2f8cd728ee66&pf_rd_s=merchandised-search-6&pf_rd_t=101&pf_rd_i=495310&pf_rd_m=ATVPDKIKX0DER&pf_rd_r=HVP7J9SE8R6AY1DSA6ZQ&pf_rd_r=HVP7J9SE8R6AY1DSA6ZQ&pf_rd_p=7d87df11-afce-5e10-8550-2f8cd728ee66
Banana plug connectors	https://www.ebay.com/sch/i.html?_nkw=banana+plug+connectors&ul_noapp=true
Countersunk head screws	<p>https://www.microscrews-shop.nl/c-3785397/verzonken-kopschroef-din-963-staal/</p> <p>https://www.elfadistrelec.no/en/mechanical-components/screws-dowels/screws/c/cat-DNAV_PL_170101?q=*&filter_Buyable=1&filter_Category3=Screws&pageSize=100&sort=Thread%3Aasc</p>
Nut	<p>https://www.elfadistrelec.no/en/mechanical-components/screws-dowels/nuts/c/cat-DNAV_PL_170102</p> <p>https://www.conrad.nl/o/schroeven-bouten-moeren-c19749</p>
Magnet elevator door, Magnet elevator top, Magnet rope	https://www.imagnetshop.com/en/neodymium-magnets/disc-magnets-neodymium/
Rope	https://www.kbeads.com/p-1065121-1-roll-clear-nylon-wire-fishing-line-0-4mm-about-40m-roll.html?currency=GBP&gclid=CjwKEAjuwue3nBRCCyrqY0c7bw2wSJACslmGZeb2lXM9Mltiku2csK4FtgcGkthmDkSJT3K8VWQmVmRoCUX7w_wcB
Motor	https://www.elfadistrelec.no/en/automation/motion-drives/dc-motors/iron-core-dc-motors-with-gear-drive/c/cat-DNAV_PL_12100402?q=*&sort=Price%3Aasc&filter_Buyable=1&filter_Category4=Iron-Core+DC+Motors+with+Gear+Drive&filter_Category3=DC+Motors&pageSize=100
Motor clamps	https://pvcbuis.com/gaspijzadels/
Lego man	https://shop.lego.com/nl-NL/product/THE-LEGO-MOVIE-2-71023