



UiT The Arctic University of Norway

## Electric ships in Norway

*Experiences and Future Trends*

Bjarte Hoff

*Associate professor  
Department of Electrical Engineering  
Head of research group "Electromechanical systems"  
ARC – Arctic Centre for Sustainable Energy*



# Electric transport is not new

- The inventor Thomas Parker –  
First electric vehicle in production  
in 1884 by Elwell-Parker Company
- First German made EV in 1888 by  
Andreas Flocken
- First American EV in 1891 by  
William Morrison



- Thomas Edison charging  
station for EVs  
(1897?)

# Maritime electric propulsion



- Known technology from diesel-electric vessels
- Diesel generators can be replaced by batteries

# Battery prices are being reduced

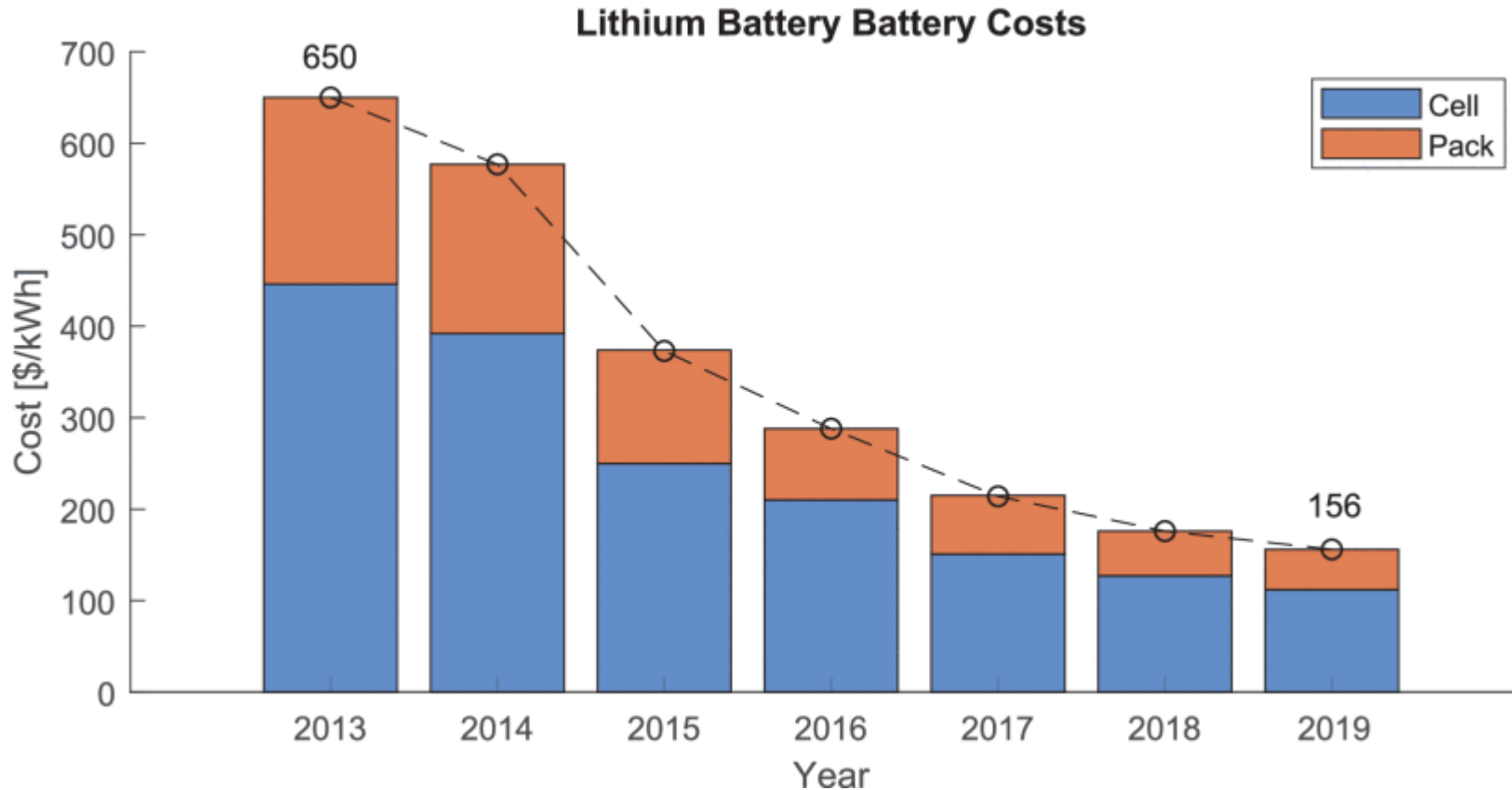

M. Stecca, L. R. Elizondo, T. B. Soeiro, P. Bauer and P. Palensky, "A Comprehensive Review of the Integration of Battery Energy Storage Systems Into Distribution Networks," in *IEEE Open Journal of the Industrial Electronics Society*, vol. 1, pp. 46-65, 2020, doi: 10.1109/OJIES.2020.2981832.

# Electric transport in Norway



- All car ferries should be fossil free by 2030

Antall elektriske biler over tid

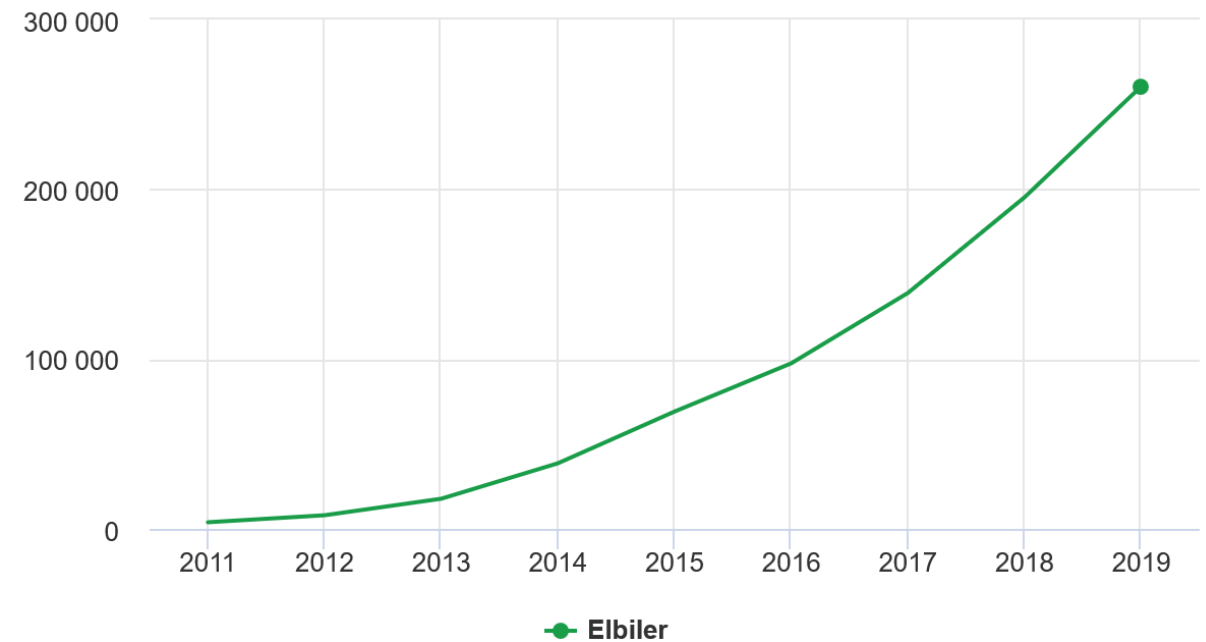

Kilde: Bilparken, Statistisk sentralbyrå

- Electric vehicles in Norway



# Worlds first electric car ferry



- Produced by Fjellstrand AS for Norled
- Electric propulsion system by Siemens
- Battery capacity 1040 kWh
- Transit duration 20 minutes, uses 130 – 200 kWh

# Development of electric ferries



- World's first electric ferry in 2015: Ampere
- Norwegian government: All (200) on electricity within 2025 (more realistic with 2030)
- In addition comes biofuel and hydrogen

# Fish farming goes electric



Illustrasjon: ABB



[Sea trial movie](#)

## Health and safety:

- No exhaust fumes
- Reduced noise
- Less vibration

## Environment:

- No local CO<sub>2</sub> emissions
- No NOX emissions



# Electric fishing boats



Image: Selfa

## Selfa Arctic EI-Max 1099

- Electric hybrid
- 195 kWh battery + diesel generator



Image: VM boats

## VM 900 Fischer

- Electric fishing boat
- 120 kWh battery
- Range of 25 nmi at 6 knop



# Hybrid fishing boat – “Angelsen Senior”



# Typical electric propulsion system

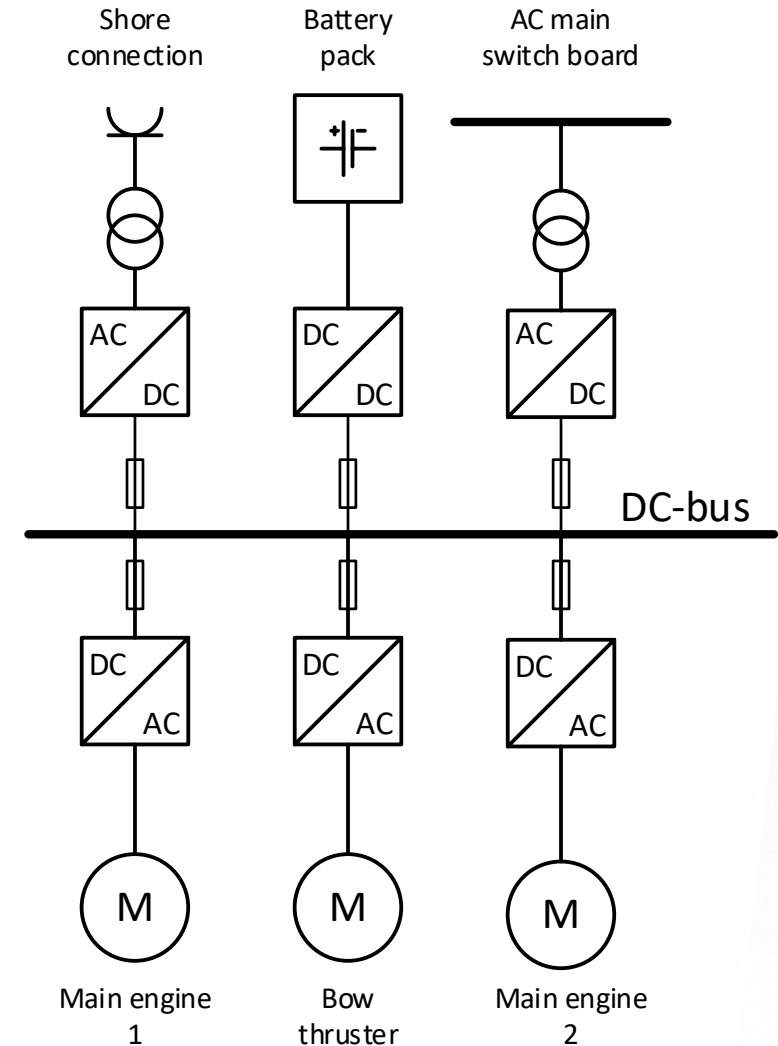
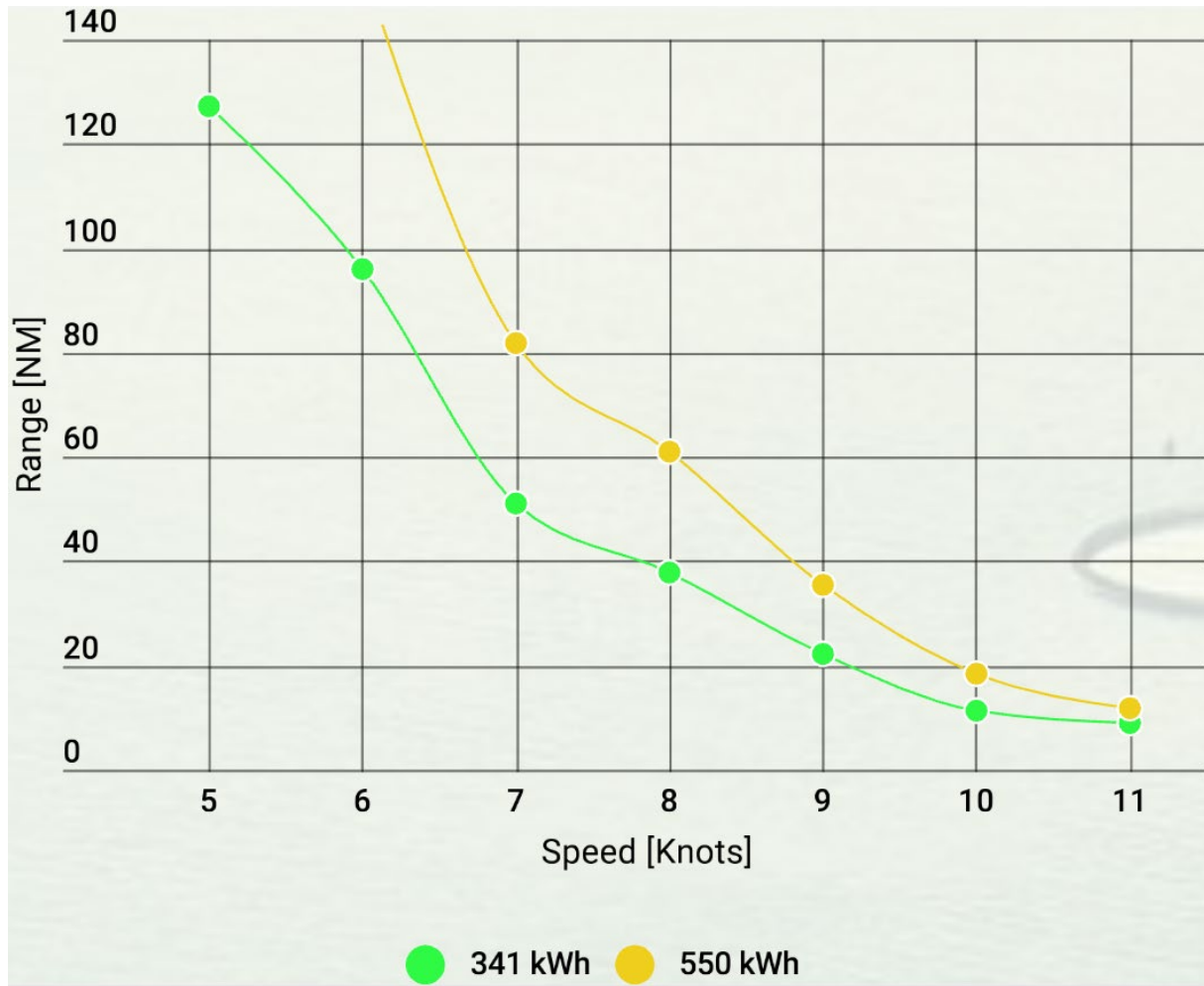



# Charging requirement and technology



Vessel	Battery capacity	Charging power	Charging solution
Karoline (Hybrid)	195 kWh	44 kW	63 A plug 400 V
Angelsen Senior (Hybrid)	270 kWh	50 kW 850 kW gen.	125 A 3~ 230 V
GMV Zero	350 kWh	2 x 87 kW	2 x 125 A plug 400 V
MF Folgefonn (Hybrid)	1000 kWh	1 MW	Inductive + NG3 plug
MF Ampere	1040 kWh	1.2 MW	ST.Pantograf Cavotec plug
MF Future of the Fjords	1800 kWh	2.1 MW	Cavotec plug
Color Hybrid	5000 kWh	7 MW	NG3 plug

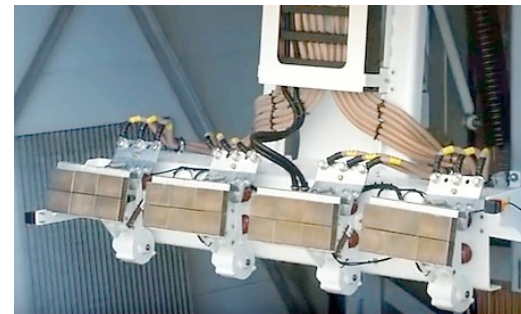
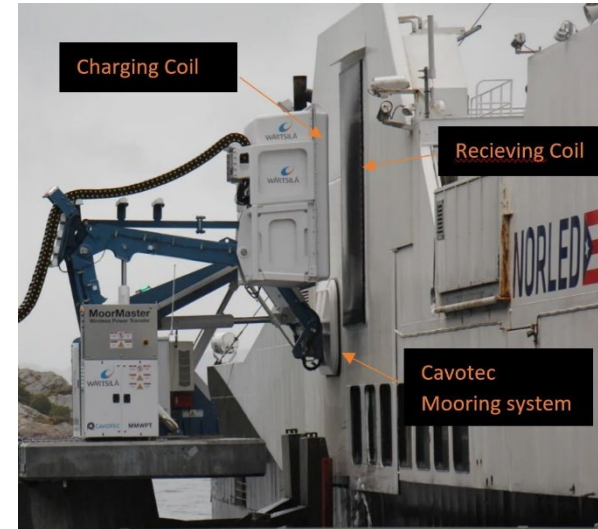



# Floating charging points

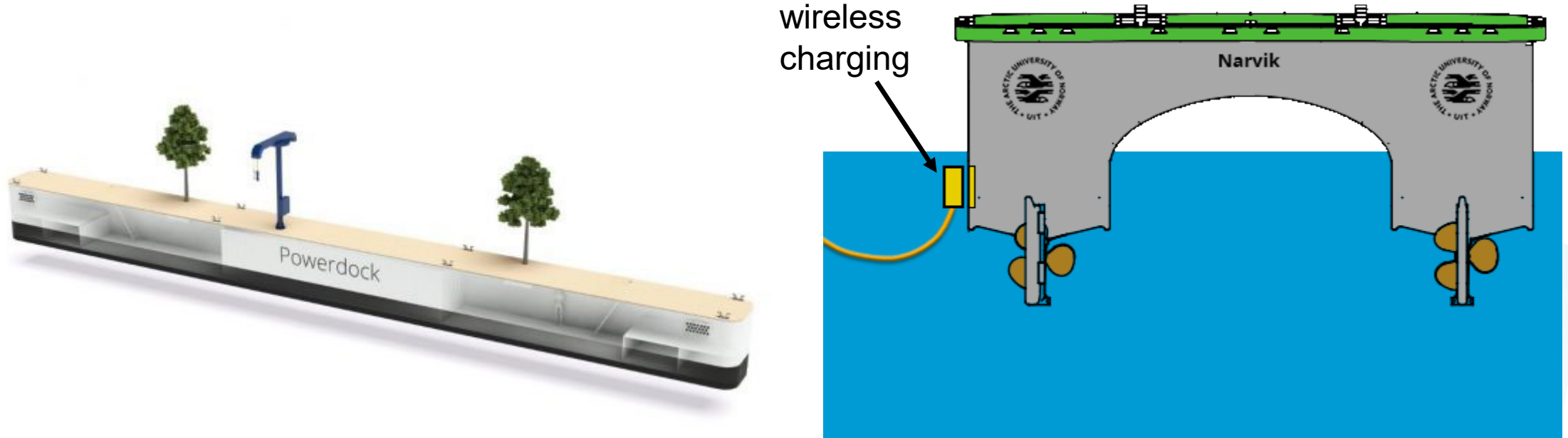

- Power dock with integrated battery pack
- UiT research – Underwater wireless charging

# Students interested in electric vessels

Søkte én til to – ansatte ni personer



**LADING PÅ HJERNEN:** BAK FRA VENSTRE: SURAJ TIMILSINA, JONAS NYSTAD, SIMON FJELLSTRØM JENSEN, SHAMRAIZ KHAN, ABDALLA ALAAELDIN MAHMOUD ABDELLATIF. FORAN FRA VENSTRE: JEEWAN YOUSUF ADEEL. IKKE TIL STEDE: HAFEZ ABOLADE OMOSENYA OG HENRIK FJELD NILSEN. FOTO: PRIVAT

UiT i Narvik søkte i utgangspunktet én til to forskningsassistenter til prosjekt. Etter stor interesse endte de opp med å tilsette hele ni.



**Ladeteknologi**  
for elektrifisert framdrift av  
maritime fartøy og luftfart

<http://www.ladeteknologi.no>



# Electric boat collecting plastic waste





# Armada



Grovfjord Mek. Verksted is building nine autonomous hybrid vessels for Ocean Infinity