



BIO-3930 MASTER 'S THESIS IN BIOLOGY

The antioxidant system of arctic seabirds and the effect of HOCs on antioxidant capacity of kidney tissue

Marta Karoline Jansen

May, 2010



Faculty of Health Sciences
Department of Medical Biology
University of Tromsø



BIO-3930 MASTER 'S THESIS IN BIOLOGY

The antioxidant system of arctic seabirds and the effect of HOCs on antioxidant capacity of kidney tissue

Marta Karoline Jansen

May, 2010



Faculty of Health Sciences
Department of Medical Biology
University of Tromsø

Front cover photo by

Anne Svenstrup
(herring gull chicks)

Guttorm Christensen
(kittiwake, common eider and northern fulmar)

**Master Thesis in Biology
Pharmacology and toxicology**

**The antioxidant system of arctic seabirds and the effect of
HOCs on antioxidant capacity of kidney tissue**

Marta Karoline Jansen
May 2010

**Faculty of Health Sciences
Department of Medical Biology
University of Tromsø**

This thesis has been done in collaboration with

Akvaplan-Niva AS

Preface

This master thesis has been written at Akvaplan-Niva AS (APN) at the Polar Environmental Center in Tromsø and the Department of Medical Biology of the University of Tromsø in collaboration with the Norwegian Polar Institute and the Università Politecnica Delle Marche, Ancona, Italy. The project was financed by the Norwegian Research Council. The field work was performed at Ringvassøya, havbruksstasjon. The laboratory analysis for biomarkers have been performed at the eco-toxicology laboratory in Akvaplan-Niva AS and at the laboratory of Prof. Regoli the Università Polytecnica Delle Marche, Ancona, Italy. This thesis is a part of the project “Biotransformation of halogenated organic compounds and associated biological effects in Arctic seabirds”. My supervisors have been Associate Professor Lionel Camus (Akvaplan-niva and University Center In Svalbard), Associate Professor Lisbeth Aasmoe (University of Tromsø), and Marit Hegseth (Akvaplan-niva and University of Tromsø). I want to give my sincere thanks to you all for the good help and support you have provided through all parts of this thesis. Thanks are also deserved to the COPOL project, Guttorm Christensen (Akvaplan-niva) and Anita Evenset (Akvaplan-niva) especially, for providing me with samples. This study has been approved by the animal welfare authorities in Norway. Thanks to the team in Kårvika, the very talented gull-mamas! It was an experience I’ll never forget. During the last year I have spent a lot of time in Akvaplan-Niva. I’m very grateful for the care I’ve received in this company and for the great parties with amazing arrangements. I would also like to thank my office mates for providing a merrily, yet productive atmosphere, even through my most frustrating times of thesis writing. My dear friends outside the office that I think barely will recognise me after finishing thesis and finally exit the office. To my family back home who patiently has given me support through all my studies. I thank you for this and look forward to be more present in the future. And to Dima for always knowing what I need.

The front page photos are taken by Guttorm Christensen and Anne Sveistrup. Thank you very much for excellent photographic skills.

Abstract

The arctic is exposed to a wide range of pollutants which originate from industrialized areas located in temperate regions. Halogenated organic contaminants (HOCs) are of special concern due to their persistency and ability to bioaccumulate. Consequently, animals high in the food chain, such as marine seabirds, are prone to accumulate high levels of these compounds. The HOCs are known to increase the formation of free radicals through metabolism and thereby jeopardise the balance between pro and antioxidant forces, which could lead to oxidative stress and therefore severe biological cell dysfunctions. The antioxidant system of kidney tissue of arctic seabirds has previously not been investigated as an organ for measuring effects of HOCs. In this study, single antioxidant parameters were measured in kidney tissue of three species of seabirds to investigate their species specific differences in antioxidant defences. The antioxidant parameters, catalase and glutathione peroxidase, glutathione reductase and total glutathione levels, revealed different species-specific antioxidant strategies in common eider, kittiwake and northern fulmar which are related to abiotic and biotic factors. In addition an experimental study was performed on herring gull chicks to assess the cause-effect relationship of exposure to HOCs, following parental transfer during feeding, and fasting on the total oxidative scavenging capacity (TOSC) of their kidney tissue. The TOSC assay provides an antioxidant scavenging profile, showing that exposure to HOCs significantly decrease the TOSC towards hydroxyl radicals and that exposure and fasting significantly increase the TOSC towards peroxynitrite and peroxy radicals. We can conclude that parental transfer of HOCs to bird chicks can lead to biological effects in kidneys and effects are different between non fasting and fasting treatment. Finally, TOSC can be used as a biomarker on effects of HOCs in birds.

Table of Contents

1	Introduction	1
1.1	HOCs in the Arctic	1
1.2	HOCs properties.....	1
1.3	Metabolism and storage	2
1.4	Seabirds as indicator species	3
1.5	Reactive oxygen and nitrogen species	3
1.6	The antioxidant defence system.....	6
1.6.1	Single antioxidant parameters	6
1.6.2	Scavenging capacity	8
1.6.3	Kidneys.....	8
1.7	Aim of study	8
2	Materials and methods.....	10
2.1	The sampling site and the specimens.....	10
2.2	Species description	11
2.2.1	Common eider (<i>Somateria mollissima</i>)	11
2.2.2	Kittiwakes (<i>Rissa tridactyla</i>).....	12
2.2.3	Northern fulmars (<i>Fulmarus glacialis</i>).....	12
2.2.4	Herring gull (<i>Larus argentatus</i>).....	12
2.3	Tissue preparation.....	13
2.4	Bradford protein assay	13
2.5	The catalase assay	14
2.6	Glutathione reductase (GR) assay.....	15
2.7	Glutathione peroxidase (GPX) assay	16
2.8	Total glutathione levels (Oxidized and reduced).....	17
2.9	Total Oxyradical Scavenging Capacity (TOSC) assay.....	18
2.10	Chemical analysis	19
2.10.1	Chemicals and standards	19
2.10.2	Quantification by GC/MS.....	21
2.11	Statistical processing	21
3	Results.....	22
3.1	Assessment of the species-specific antioxidant defences.....	22
3.1.1	Catalase.....	22
3.1.2	Glutathione reductase	24
3.1.3	GPX	25
3.1.4	Total glutathione levels	27
3.2	Experimental analysis.....	28
3.2.1	Chemical analysis of HOCs	29
3.2.2	Hydroxyl radicals.....	32
3.2.3	Peroxynitrite	33

3.2.4	Peroxyl radicals.....	34
3.2.5	Relationships between PCB concentration and TOSC value	34
4	DISCUSSION.....	36
4.1	Assessment of the species-specific antioxidant defences.....	36
4.2	Quantification of HOC exposure-mediated formation of free radicals	40
4.2.1	Contaminant levels	40
4.2.2	Antioxidant capacity and relationship with PCB concentration.....	40
5	Conclusions	43
6	References	45
	Appendix:	51

1 Introduction

1.1 *HOCs in the Arctic*

The general idea of the Arctic as an untouched environment is inaccurate when it comes to the prevalence of environmental pollution. Compounds produced in industrial areas located in the temperate regions are transported to the Arctic by the wind, ocean currents and rivers (AMAP 2004). A certain group of contaminants called halogenated organic contaminants (HOCs) are known to cause detrimental effects on enzyme-, immune-, hormone- and vitamin systems, leading to serious reproductive and hormonal disruptive effects (Gabrielsen 2007). HOCs have long half life and high volatility, which makes them available in the Arctic and in arctic biota. Because of their lipophilic character HOCs are able to enter the biota and accumulate. This is especially of concern for the top predator species, as they will experience biomagnification of HOCs because of the several accumulating steps through the food chain (Letcher et al. 2010). Arctic seabirds follow the same trend (Borgå et al. 2005), as a result of this, high levels have been reported in many arctic avian species: northern fulmars, kittiwakes, glaucous gull, great black-backed gull and great skua (Mehlum et al. 1995; Gabrielsen et al. 1997; Bustnes et al. 2003). Exposure to contaminants occurs mainly through the diet and pollutants are either accumulated in lipid rich tissue or metabolised and excreted (Borgå et al. 2005).

1.2 *HOCs properties*

Halogenated organic compounds (HOCs) include among others dioxins, pesticides (e.g., DDTs and chlordanes), polychlorinated biphenyls (PCBs) and brominated flame retardants (PBDEs). All characterised by complex aromatic ring structures and variable numbers of chlorine substituents or other halogens (see figure 1). These molecules are persistent and the degradation in nature and metabolism in the body is very slow. Legacy HOCs like PCB and DDT has been phased out of production since the 70's, but are still highly present in the environment (Gabrielsen 2007). The persistency and high volatility of many of these compounds makes them easily transported from industrial areas in North America and Eurasia to the Arctic. Adherence to particles in the atmosphere can contribute to transport as well as

wind current transport of highly volatile compounds. The wind and water currents cause wide spreading of HOCs to the arctic, where almost no such sources are present (Gabrielsen 2007).

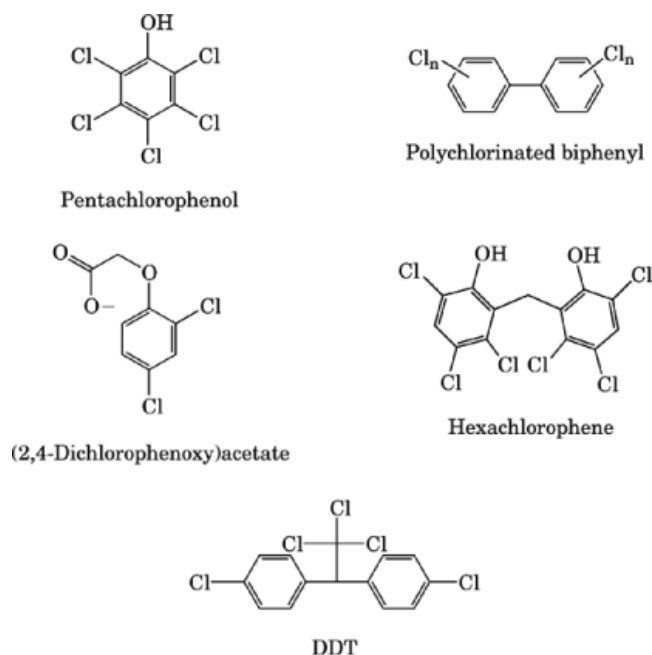

Figure 1: Examples of halogenated organic compounds (*Kirk-Othmer Encyclopedia of Chemical Technology Published by John Wiley & Sons, Inc.*).

1.3 Metabolism and storage

The high levels of halogenated organic compounds (HOCs) in the arctic environment are of great concern regarding the health of arctic animals (AMAP 2009). Such contaminants are degraded very slowly in the environment and are thereby thought to cause high contaminant levels up in the food chain. The substances are highly lipophilic and thereby are accumulated in high amounts in adipose tissue of arctic animals and especially in seabirds due to their relatively slow degradation of these contaminants (Gabrielsen et al. 1997). During starvation the compounds can be released from the adipose tissues to the circulation and transported to different organs in the body. Starvation of mammalian and fish species is known to have pro-oxidant effects and is one of the main factors causing reduced health during food deprivation (Robinson et al. 1997; Morales et al. 2004). The body mass of a breeding arctic seabird fluctuates greatly throughout the year (Gabrielsen et al. 1992). Stressful periods (e.g., breeding and food deprivation) have shown to mobilise the contaminants located in fat and result in highly elevated levels in glaucous gulls (Sagerup et al. 2009).

Metabolism can be divided in two phases; phase I and phase II. For HOCs phase I metabolism include oxidation by CYP 450 enzymes (Helgason et al. 2010). The specific enzymes vary according to species and the specific compound (Letcher et al. 2000; AMAP 2004). CYP 450 enzymes activity is highly induced by HOCs (AMAP 2004), and this high activity leads to production of hydrogen peroxides and superoxides (figure 3), two highly potent radical species. One link between pollution and free radical production is phase I degradation of HOCs, which results in great formation of free radicals (Lech et al. 1980; Lehtinen 1990). Another more direct link is redox cycling, where a chemical/toxin is reduced by the cellular system to give a molecule oxidised by O₂, resulting in production of superoxide (O₂⁻), and regeneration of the original compound (Lehtinen 1990; Winston et al. 1991; Halliwell et al. 1999).

1.4 Seabirds as indicator species

Marine birds are a major link between marine and terrestrial ecosystems. They are an important element in the marine food web as top predators (Anker-Nilssen et al. 2000; Timofeev 2001). Outside breeding season arctic seabirds spend most of their time at sea foraging fish, for the kittiwake, northern fulmar and herring gull, or mussels, for the common eider. Newly hatched chicks are readily exposed to the environmental contaminants due to parental transfer. This is done partly by egg deposition from parents with high contaminant levels and partly by parents through the diet. Seabirds are an important animal group to investigate the anthropogenic effects on the ecosystem. In fact the marine food chains are particularly exposed to accumulation of HOCs (Gabrielsen et al. 1997). Therefore looking at the top predators of the marine ecosystem is highly relevant when trying to assess the effects of natural and anthropogenic influences. Changes to their body function might reflect the changes in the lower trophic levels as well, providing an early sign on ecosystem changes. The arctic seabirds used in this project are common eider, kittiwake, northern fulmar and herring gull. Further species descriptions on biology are included in section 2.1.

1.5 Reactive oxygen and nitrogen species

Relatively high HOC exposure in arctic seabirds due to their high trophic level in the food chain may lead to the generation of reactive oxygen species and consequently oxidative stress

which can harm cell functions. This occurs when the balance between the reactive oxygen species and the oxidative defence system is no longer maintained, which can cause severe damage to many of the most important molecules in the body (e.g., lipids, proteins and DNA) (Halliwell et al. 1999). However, it is important to distinguish between natural levels of reactive species and harmful levels as when ROS formation exceeds antioxidant defence capacity, called oxidative stress. It is also noteworthy that reactive species is useful for the biological system to some extent as a messenger molecule (e.g. nitric oxide, NO) (Bredt et al. 2003).

Reactive oxygen species (ROS) and nitrogen species (RNS) are produced through many biological processes by partial reduction of molecular oxygen. During general cell activity reactive species formation is produced at different sites in the cell (see figure 2), including various cytochrome P450 enzymes, phagocytose, oxygenase enzymes, oxidase, and the mitochondrial electron transport chain (Kehrer 1993; Winston et al. 1998; Halliwell et al. 1999).

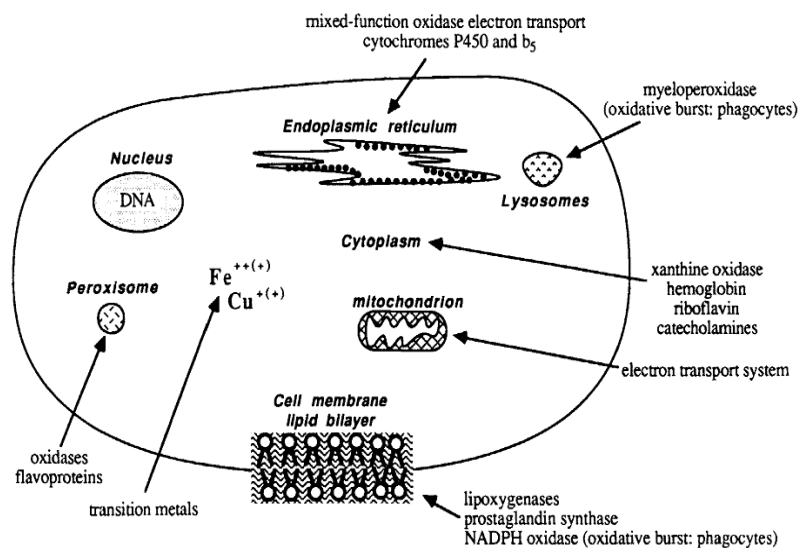

Figure 2: Cellular sources of free radicals. Free radicals are produced by cells through the action of various soluble and membrane-bound enzymes. (Kehrer 1993)

The reactivity of free radicals (e.g., hydroxyl, superoxide, peroxy radicals (LOO, ROO) and nitric oxide) and chemically important non-radicals (e.g., hydrogen peroxide and peroxyxynitrite) depends highly upon the reactive species and its target, but the main action of reactive species are to oxidise other compounds by subtracting an electron. The eagerness to retrieve an electron is explained by the free radical molecules' unpaired electron in outer orbit

(McCord 2000). This makes them generally unstable and highly reactive, making a threat to important biochemical molecules in the body. A free radical reacting with a non-radical molecule can potentially be cytotoxic by creating a new radical starting a cascade of reactive molecules (Kehrer 1993; Halliwell et al. 1999). Superoxide is the first radically reactive product of oxygen entering the cell and is a highly reactive molecule ready to interact with other elements. The most toxic/ harmful product of free radicals are the hydroxyl(OH) that directly can damage lipid of cell membranes, DNA and proteins. The production and reaction pathways of oxidative species in mammalian cells are summed up in figure 3, assuming homogeneity with bird cells.

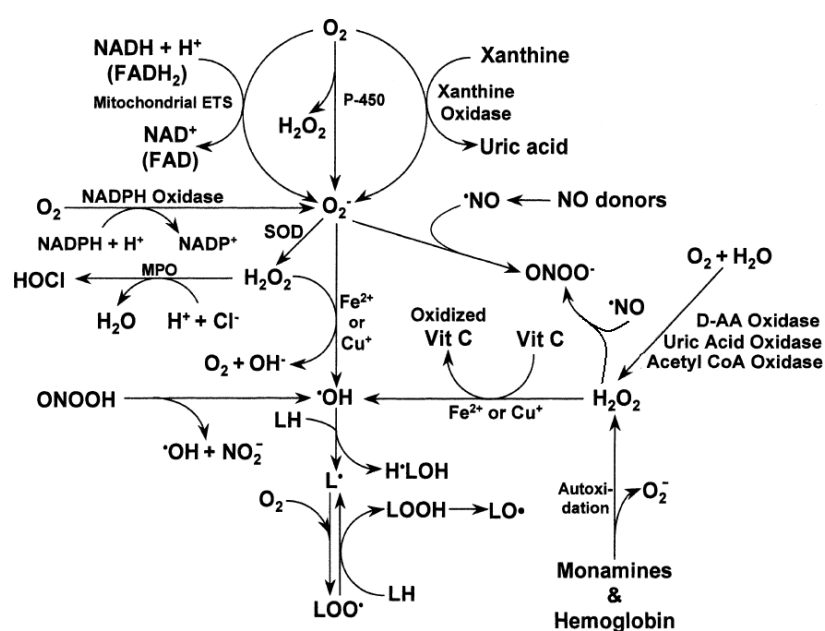

Figure 3: Production of oxygen and nitrogen reactive species in mammalian cells. AA, amino acid; Cit, L-citrulline; ETS, electron transport system; H₂O₂, hydrogen peroxide; HOCl, hypochlorous acid; H•LOH, hydroxy lipid radical; L•, lipid radical; LH, lipid (unsaturated fatty acid); LO•, lipid alkoxy radical; LOO•, lipid peroxy radical; LOOH, lipid hydroperoxide; MPO, myeloperoxidase; NAD⁺, nicotinamide adenine dinucleotide (oxidized); NADH, nicotinamide adenine dinucleotide (reduced); NADP⁺, nicotinamide adenine dinucleotide phosphate (oxidized); NADPH, nicotinamide adenine dinucleotide phosphate (reduced); •NO, nitric oxide; O₂⁻, superoxide anion radical; •OH, hydroxyl radical; ONOO⁻, peroxynitrite; P-450, cytochrome P-450; SOD, superoxide dismutase; Vit C, vitamin C. Reproduced from (Fang et al. 2002).

Several environmental pollutants are known to stimulate the free radical formation (Regoli 2000). No such studies have been performed on arctic seabirds. Their close connection to the marine environment where the levels are high of HOCs and their relatively low ability

efficiently to metabolise HOCs (Gabrielsen et al. 1997), may provoke an imbalanced antioxidant defence and lead to oxidative stress.

1.6 The antioxidant defence system

The antioxidant system is an intricate defence that is highly depending on several components (Halliwell et al. 1999). There is a fine cooperation of different cellular enzymes (e.g. catalase and glutathione peroxidase) and low molecular weight scavengers (e.g. vitamins and reduced glutathione) to disarm reactive species.

1.6.1 Single antioxidant parameters

A complex antioxidant system has evolved to protect the cells against damaging reactive species (Winston et al. 1991), summed up in Figure 4. Detection of ROS and NRS can be a difficult task because they undergo numerous cellular mechanisms of both enzymatic (e.g. catalase and glutathione peroxidase) and non-enzymatic (e.g. vitamins and reduced glutathione) involvement (Tarpey et al. 2004). The antioxidant system is an intricate defence that is highly depending on its several components with a complex overlapping nature of the antioxidant activity (Tarpey et al. 2004). The enzymes metabolize selectively reactive species (e.g. catalase scavenge hydrogen peroxidase), while the non-enzymatic approach of the low molecular weight scavengers is to passively adhere to the ROS/NRS and thereby disarm its damaging reactivity (Winston et al. 1991).

The glutathione complex and its cycling process is a highly important element of the antioxidant system. Reduced glutathione (GSH) is one of the most important non-enzymatic oxidant defence element within the body, due to its high abundance and contribution in detoxification of hydroxyl radicals, peroxy radicals and support to other important antioxidants (Vitamin E and C) (Tarpey et al. 2004). Reduction of glutathione is a continuously cyclic process driven by glutathione peroxidase (GPX) to form oxidised glutathione (GS-SG) and glutathione reductase (GR) to form GSH (see figure 4). This makes it interesting to look at these enzymes activity when trying to assess the topic of antioxidant system.

The enzyme activity of catalase is mainly constrained to peroxisomes where much of the H_2O_2 is generated by oxidases. Its distribution throughout all animal tissue makes it highly interesting as a single antioxidant parameter when trying to assess the state of the antioxidant system. Catalase enzymes catalyses the following decomposition



With fixed concentration of H_2O_2 the concentration of catalase will be proportional to its abundance and can be used to assess catalase activity.

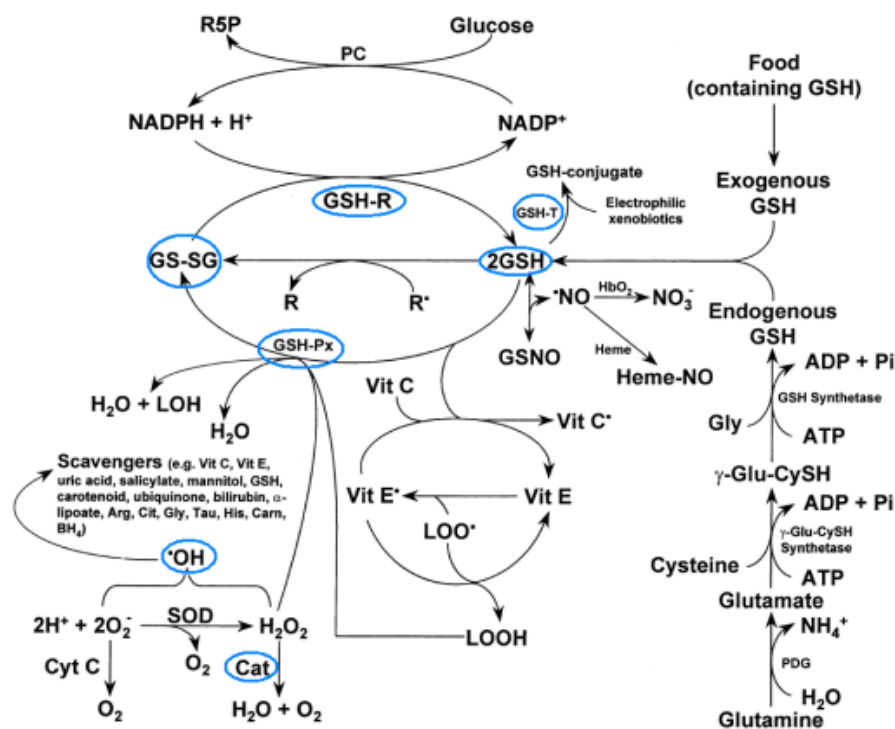

Figure 4: Removal of oxygen and nitrogen reactive species in mammalian cells. The targets outlined have been investigated in this paper. ADP, adenosine diphosphate; Arg, arginine; BH₄, (6R)-5,6,7,8,-tetrahydro-L-biopterin; Carn, carnosine; Cat, catalase; Cit, citrulline; Cyt C, cytochrome C; ETS, electron transport system; Glu, L-glutamate; Gly, glycine; γ -Glu-CySH, γ -glutamyl-cysteine; GS-SG, oxidized glutathione (glutathione disulfide); GSH, glutathione (reduced form); GSH-Px, glutathione peroxidases; GSH-R, glutathione reductase; GSH-T, glutathione S-transferase; GSNO, nitrosylated glutathione; HbO₂, oxyhemoglobin; Heme-NO, heme-nitric oxide; His, histidine; LOH, lipid alcohol; LOO•, lipid peroxy radical; LOOH, lipid hydroperoxide; •NO, nitric oxide; NO₃⁻, nitrate; O₂⁻, superoxide anion radical; ONOO⁻, peroxynitrite; PC, pentose cycle; R•, radicals; R, non-radicals; R5P, ribulose 5-phosphate; SOD, superoxide dismutase; Tau, taurine; Vit C, vitamin C (ascorbic acid); Vit C•, vitamin C radical; Vit E, vitamin E (α -tocopherol); Vit E•, vitamin E radical. Reproduced from (Fang et al. 2002).

1.6.2 Scavenging capacity

Total oxidant scavenging capacity is a method to quantitatively measure the antioxidant defence system to remove/scavenge reactive species from the tissue environment (Regoli 2000). This assay opens up for the possibility of measuring the overall resistance of the cell to certain reactive species like hydroxyl radicals (OH), peroxy radicals (ROO) and peroxynitrite (ONOO). The method is based on the reaction between the reactive species and α -keto- γ -methiolbutyric acid (KMBA) which is oxidised to ethylene. The production of ethylene gas measured by a highly sensitive gas-chromatograph is proportional to the ROS scavenging capacity of the tissue (Winston et al. 1998).

1.6.3 Kidneys

After digestion and metabolism of HOCs through the diet, the contaminants will be available in the blood, circulating throughout the whole body. Therefore, the kidney is a filter organ that is continuously exposed to HOCs and its metabolites present in the blood. The organ is therefore a highly relevant object of investigation of effects of HOCs on the antioxidant system. The levels of antioxidant enzymes are generally lower in kidney compared to the liver organ, but it is mostly elevated compared to other organs in the body (Halliwell et al. 1999). The effects of HOCs exposure to the kidney tissue of arctic seabirds are still unknown regarding oxidative stress, and needs to be explored to understand the whole impact on the organism. There is no information present on the antioxidant defences in kidney tissue of seabirds and very little on the avian group in general (Costantini 2008).

1.7 Aim of study

The aim of the study is to assess the species-specific antioxidant defences in northern fulmars, common eider and kittiwake through the single antioxidant parameters: Catalase, glutathione reductase, glutathione peroxidase and levels of glutathione (reduced and oxidised). These parameters will provide a comprehensive understanding of the oxidative status of the bird in relation to biotic and abiotic factors. The second aim of the study was to carry out an experimental study under controlled conditions to reproduce the parental transfer of HOC to

herring gull chicks. Additionally, combined effect of HOCs and fasting was performed. The effect of HOCs and/or fasting on the antioxidant defence system of herring gull chicks was measured using a method to quantify the total oxidant scavenging capacity of the kidney cells.

2 Materials and methods

2.1 *The sampling site and the specimens*

Kidney tissue of northern fulmars (*Fulmarus glacialis*, $n=8$), common eider (*Somateria mollissima*, $n=10$) and kittiwakes (*Rissa tridactyla*, $n=10$) were sampled in Kongsfjorden (figure 5, green dot) summer 2009. Kongsfjorden is a sub-Arctic fjord, situated on the Western side of the Svalbard archipelago in the Norwegian Arctic. The fjord is influenced by both the Atlantic current and the arctic water currents. The research settlement of Ny-Ålesund is situated in the inner part of this fjord. Non-breeding and adult individuals were shot with shotgun in end of July, dissected and frozen (-80) immediately to retrieve among other the kidney tissue used in this thesis.

40 Newly hatched herring gull chicks (*Larus argentatus*) were collected at Sommarøy, Troms (figure 5, blue dot) in June, 2008. They were kept in outdoor cages and were separated into two treatment groups, control and exposed. The chicks were exposed to HOCs through their diet. Exposed group was served herring and natural fish oil, while the control group was given herring and rinsed fish oil. At the end of the experiment half of the individuals in each treatment group were fasted 15 % of their body weight. After eight weeks in captivity the kidney tissues of the four different treatment groups were compared to a reference group (wild living individuals) caught from boat near Sommarøy in 2007. All treatment groups analysed consisted of eight individuals. The tissue was instantly frozen with liquid nitrogen (-80) after dissection. The sex was determined and turned out to be evenly distributed throughout the treatment groups.

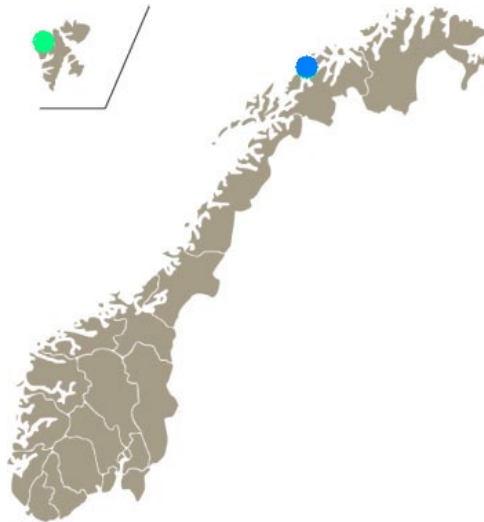

Figure 5: Map of Norway, Sommarøy and Svalbard, Kongsfjorden with the sampling site of Herring gull (blue dot) and Kittiwake, Common eider and Northern fulmar (green dot).

2.2 *Species description*

These species represent different trophic levels with eider duck being the lowest, followed by kittiwake, northern fulmar and on top the herring gull (Gabrielsen 2007).

2.2.1 *Common eider (Somateria mollissima)*

Common eider is a large maritime duck of approximately 1200-2800 g. It has a circumpolar distribution and nest mostly on small islands isolated from mammalian predators along coast of Europe, North America, Greenland, Siberia and Svalbard. This seabird species represents a lower step on the food chain than subsequent species to be described. They belong to the benthic food chain, having a diet consisting of mussels, other benthic animals and amphipods. In Svalbard the male duck goes off to moult 1-2 weeks after start of incubation, whereas the female stays to rely on her fat deposits while taking care of the offspring development. The oldest specimen registered is 24 years old (Strøm 2006). The important role of blue mussel in their diet is posing a threat to the common eider and especially for the female duck after starvation during incubation. The blue mussels as filter feeders easily accumulate toxins and eider ducks may eat 2 kg mussels per day. (Bustnes et al. 2000; Strøm 2006).

2.2.2 Kittiwakes (*Rissa tridactyla*)

Kittiwake is the most numerous gull in the world and very oceanic. It thrives in the Arctic and boreal zone, having a pelagic lifestyle outside breeding season and before adult stage of life. Long foraging trips during breeding is characteristic (Strøm 2006). They have a relatively high metabolic rate and consequently a high cost of flying (Gabrielsen et al. 1987; Gabrielsen et al. 1988). The diet consist mainly of capelin (*Mallotus villosus*), polar cod (*Boreogadus saida*) and amphipods (Mehlum et al. 1993). The highest known age recording is 19 years old (Barett et al. 2000).

2.2.3 Northern fulmars (*Fulmarus glacialis*)

Northern fulmar is distributed in the north Atlantic and high Arctic. This pelagic species spends its whole life at sea except from breeding season, having a nomadic life. They have a low metabolic rate, low body temperature, good insulation and the ability to store oils. All these factors contribute in surviving the harsh climate of the Arctic (Gabrielsen et al. 1988). It is very abundant on Svalbard with 125 colonies, breeding on the upper part of steep cliffs (Strøm 2006). Due to late maturity (11 year old) and one egg per year it implies that it invests a lot in its offspring. It has been recorded extremely long distance flying during chick rearing period (from fjords in west Spitsbergen to Bjørnøya and Novaya Zemlya). Its lifespan is measured up to 50 years old (Strøm 2006). The diet is mainly crustaceans, cephalopods, fish, offal, discards and carrion, squids, polar cod and a many marginal ice zone species (Bakken et al. 2000). Relative high levels of organochlorinated compounds (OCs) are reported as a threat to this species (Mehlum et al. 1994).

2.2.4 Herring gull (*Larus argentatus*)

Herring gull is distributed in connection to the Atlantic sea, highly abundant on the coast of northern Europe. It colonizes on grassy inlands or bird cliffs in the breeding season. This migratory bird feed on capelin, crabs, seabird chicks/eggs and offal (Lorentsen et al. 2000). When the fish stocks are low, the herring gull scavenges at garbage dumps and is a highly adaptive opportunist. Its general food consumption displays a role in the highest trophic level of the food chain (Lorentsen et al. 2000). Environmental contaminants are known to cause several physiological changes especially to arctic seabirds in the top levels of the food chain and herring gull is regarded to be a top predator in category with glaucous gull on natural exposure level (Gabrielsen 2007).

2.3 Tissue preparation

For single antioxidant measurements:

Kidney tissue from seabirds from Kongsfjorden were homogenised in 5x volume of ice cold 0.05 M PBS, phosphate buffer, pH 7.4, and centrifuged at 15 000 g for 25 minutes at 4°C in eppendorf tubes. The S9 fraction (1:5, supernatant) was aliquoted in ten tubes (approximately 100 µl in each). Samples were immediately frozen and stored at -80°C until analysis.

For the TOSC assay:

Kidneys were dissected from 32 Herring gull individuals, divided into four replicates, immediately frozen in liquid nitrogen and stored at -80°C. The samples were homogenized in five volumes (volume = five times (ml) the weight of kidney tissue (mg)) of 50 mM potassium phosphate buffer (100 mM KH₂PO₄, 1.8% NaCl), pH 7.5 and centrifuged at 100 000 x g for 70 min. The cytosolic fraction of the samples was aliquoted in 5 tubes and kept at -80°C.

2.4 Bradford protein assay

The protein concentrations in the samples were determined using the Bradford protein assay, a standard curve with bovine serum albumin as the protein standard (Bradford 1976). The standard curve was made of the readings of eight different dilutions of standard solution (1mg/ml). End concentration was 0, 0.01, 0.02, 0.03, 0.04, 0.05, 0.06 and 0.08 mg/ml. Bradford solution (comassie blue) was diluted with water 1:5 before 250 µl was added to the wells containing either 100 µl standard or sample-S9 fraction (diluted with PBS buffer 1:2000). Absorbance of standard (triplets) and samples (quartets) were measured with a plate reader (Perkin Elmer's Victor³ 1420 Multilabel Counter) for 2 min at 595 nm and data was processed by using the software Wallace 1420 Workstation.

2.5 The catalase assay

Measurements of the decomposition of hydrogen peroxide (H_2O_2) was performed spectrophotometrically (Aebi et al. 1984) in the UV area of light spectra (240 nm, reading every 0.1 sec. for 65 sec.) using Software Lambda to handle the data computation. The cuvette with the blank sample) contained only PBS buffer (1450 μl), and 10 mM H_2O_2 was added. The blank signal was a steady line at absorbance = 1. Sample-S9 fraction was diluted 10x, 13 μl added to buffer and 10 mM H_2O_2 per reading, in triplets.

Absorbance (A) is defined by the Beer Lambert equation

$$A = -\log(I_1/I_0)$$

Where I_0 is the initial light intensity and I_1 is the intensity after absorption of light by the sample in the cuvette (figure 6).

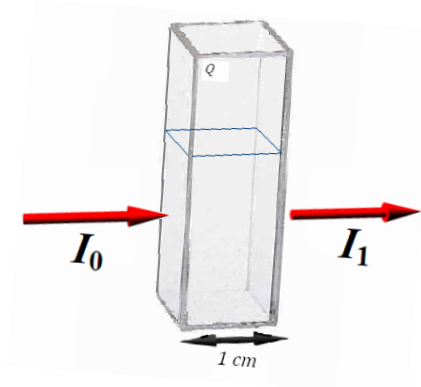

Figure 6: Measurements of optical density in a spectrophotometer. The initial light intensity I_0 is compared to the light intensity after transmittance I_1 .

The activity of catalase enzyme can be calculated from the linear slope registered as concentration of H_2O_2 in the cuvette decreases. The reaction rate is proportionally when catalase is present, and thereby calculation can be done according to the formula:

$$\text{Activity (U/mg protein)} = \text{Slope}/(\epsilon_{\text{H}_2\text{O}_2} \times (\text{Protein reading/ml sample in assay}))$$

The extinction coefficient ($\epsilon_{\text{H}_2\text{O}_2}$) is a unit of measure describing how strongly a specific substance, in this case H_2O_2 , absorbs light at a given wavelength. The spectrophotometer measurements were performed at room temperature.

Bradford assay was used to obtain the protein concentration of the individual samples S9-fraction. One catalase unit (U) is the amount of enzyme decomposing $1.0 \mu\text{mol}$ of hydrogen peroxide per minute, with initial H_2O_2 concentration of 10.3 mM .

2.6 Glutathine reductase (GR) assay

The activity of Glutathione reductase (see figure 7), GR, is measured by investigating the rate of Nicotinamide adenine dinucleotide phosphate (NADPH) oxidation (Carlberg et al. 1985).

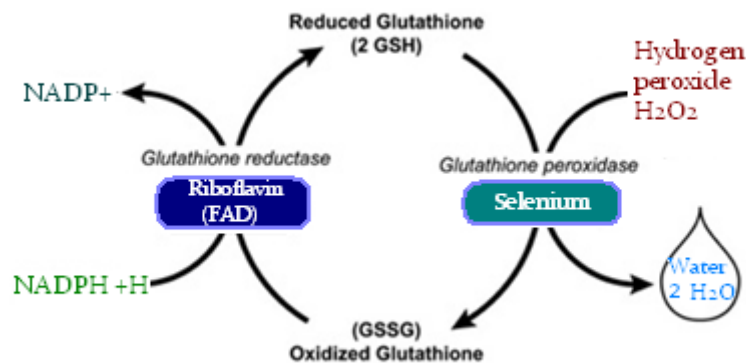

Figure 7: The glutathione cycle: Two molecules of GSH are oxidised to GSSG by glutathione peroxidase, while in the same process a molecule of hydrogen peroxide are reduced to two molecules of water. To complete the cycle oxidized glutathione (GSSG) may be reduced by the flavin adenine dinucleotide (FAD)-dependent enzyme, glutathione reductase. Modified figure from <http://lpi.oregonstate.edu/infocenter/vitamins/riboflavin/gsh.html>.

During oxidation the absorbance at 340 nm decreases and is directly proportional to the GR activity in the sample. The plate wells were added assay buffer containing 0.05 M PBS, pH 7.4 and 1 mM EDTA (ethylenediaminetetraacetic acid), 1 mM GSSG (oxidized glutathione) and $20 \mu\text{l}$ blank (PBS) or $20 \mu\text{l}$ sample homogenate, and incubated for 5 min . To initiate the reactions, 1 mg/ml NADPH was added, giving a total volume of $190 \mu\text{l}$ in the well. After a quick and careful shaking, absorbance was measured once every minute with 5 time points at

340 nm, using Perkin Elmer's Victor³ 1420 Multilabel Counter with software Wallace 1420 Workstation. Each sample and blank was run in triplets. The mean delta absorbance per minute (ΔA_{min}) of the blank value was subtracted from the sample-S9 values. Following equation was used to calculate the activity of GR:

$$\text{Activity (U/mg protein)} = \text{Slope}/(\text{Ex. co}^x (\text{Protein reading}^x \text{ml sample in assay}))$$

With the extinction coefficient (Ex. co) of NADPH.

2.7 *Glutathione peroxidase (GPX) assay*

Spectrophotometrically reading (see figure 6) of GPX activity is a two-sided analysis, first investigating the selenium dependent GPX isotypes, and second measuring the total activity of GPX (used to determine the selenium independent GPX) (Griffith 1980). The assay buffer mix containing PBS buffer with 1 mM EDTA and 1 mM NaN₃ sodium azide was mixed with 2 mM reduced glutathione (GSH), 1U glutathione reductase, GR ($1U = 1 \text{ nmol NADPH oxidized min}^{-1} \text{ cm}^{-3}$) and 30 μl diluted homogenate (1:10) and incubated for 10 min. The reaction was started adding approximately 4 mM ice-cold NADPH to the cuvette, followed by approximately 0.1 mM hydrogenperoxide. The last step is necessary for the investigation of selenium dependent GPX activity. For the investigation of total GPX activity, approximately 2 mM cumene hydroperoxide, diluted in ethanol, was added to the cuvette. Each step was followed by a quick shaking. These two reactions were run in triplets for all samples at 340 nm for 2 min at a steady temperature of 27°C using Perkin Elmer's Lambda 35 UV/VIS Spectrometer. The mean delta absorbance per minute (ΔA_{min}) of the blank value was subtracted from the sample-S9 value. Further calculation was done according to the equation:

$$\text{The GPX activity (U/mg)} = (\Delta A_{\text{min H}_2\text{O}_2/\text{CHP}/0.00622) \times \text{mg protein in the cuvette}^*$$

*amount protein in the cuvette = (protein reading from Bradford assay/10) \times 0.03

2.8 Total glutathione levels (Oxidized and reduced)

Determination of glutathione levels was performed with a plate reader (Perkin Elmer's Victor³ 1420 Multilabel Counter) measuring the absorbance of reduced and oxidised glutathione at wave length of 405 nm with 8 measurements during 15 min (Baker et al. 1990). First, deproteination of the S9-samples are performed to avoid interference by sulfhydryl groups on proteins in the assay. This is accomplished by adding 25% sulfosalicylic acid (SSA) to dilute the homogenate (1:5), resulting in a concentration of 1:6 homogenate with 5% SSA. This solution was immediately mixed, followed by incubation for 10 min in room temperature. After centrifugation (8000g, 4°C, 10 min), the supernatant was diluted 1:100 in assay buffer (PBS with 1 mM EDTA) and aliquoted in 2 tubes. The standards and tube 1 was added 1M solution 2-vinylpyridinine (2-VP diluted in ethanol) with a final concentration of 0.01 M 2-VP, then mixed and incubated for 1 hour in room temperature. Tube 2 was not added 2-VP and was immediately ready for analyses. The standards were prepared according to table 1. Reduced glutathione (GSH) and oxidised glutathione (GSSG) was diluted with buffer (PBS) for a double set of standards, one set was added 2-VP to derivatize (altered chemically) GSH and thus prevent it to be read during assay.

Table 1: Standard concentrations for total glutathione assay.

	St 1	St 2	St 3	St 4	St 5	St 6	St 7	St 8
GSSG (μM)	0	0.063	0.125	0.25	0.5	1	2	4
GSH (μM)	0	0.125	0.25	0.5	1	2	4	8

50 μ l glutathione standard or S9-sample, 50 μ l DTNB (light sensitive), 50 μ l GR and 50 μ l NADPH were added to the well and then incubated for 5 min before reading the plate. All samples and standards were run both with 2-VP and without 2-VP.

Oxidation of GSH by 5,5'-dithiobis-(2-nitrobenzoic acid) (DTNB) results in accumulation of GSSG, which is subsequently reduced by GR and NADPH to yield GSH. This recycling process is causing reduction of DNTB by GSH, hence a colour increase is monitored by the plate reader. The intensity of colour is proportional to the total glutathione concentration. The unknown values of the S9-samples are thereby determined by comparison to the equivalent values on the standard curve. The S9-samples containing 2-PV were compared to the GSSG

standard curve, while S9-samples without 2-PV was compared to the GSH standard curve. All samples were run in triplets.

The mean absorbance value of standard 1 was subtracted from all other standards and S9-samples to obtain the corrected absorbance (Δ Abs). The delta absorbance (Δ Abs) slopes for each sample attained from the readings were:

[Total GSH] or [GSSG]= (Δ Abs of sample/slope of standard curve) x sample dilution

The concentration of total GSH or GSSG is presented as μ M GSH or GSSG/mg sample.

2.9 Total Oxyradical Scavenging Capacity (TOSC) assay

Peroxyntirite was produced from decomposition of 0.08 mM 3-morpholinopyridone *N*-ethylcarbamide (SIN-1) in the presence of 0.1 mM DTPA and 100 mM potassium phosphate buffer. Hydroxyl radicals were generated through Fenton reaction (1.8 mM Ascorbic acid + Fe³⁺/EDTA, with respectively 18 μ M and 36 μ M concentration in assay) in 100 mM potassium phosphate buffer. Peroxyl radicals were generated by the thermal homolysis of 20 mM 2,2'-azobis(2-methylpropionamide) dichloride (ABAP) and 100 mM potassium phosphate buffer. The individual reactions are performed in 10 ml rubber septa-sealed vials with a total volume of 1 ml added 0.2 mM α -keto- γ -methiolbutyric acid (KMBA), while kept in a 35°C bath for constant generation of oxyradicals. Each of these radicals reacts with 0.2 mM α -keto- γ -methiolbutyric acid (KMBA) to form ethylene, sequentially monitored by taking 200 μ l from the head space of the reaction vials every 12 minutes for in total assay duration of 96 min (figure 8). Hewlett-Packard (HP 5890 series II) gas chromatograph equipped with a Supelco SPB-1 capillary column (30 m \times 0.32 mm \times 0.25 μ m) and a flame ionisation detector (FID) was used to measure ethylene formation. The temperatures of the oven, injection and the FID were 35°C, 160°C and 220°C, respectively and helium was used as the carrier gas.

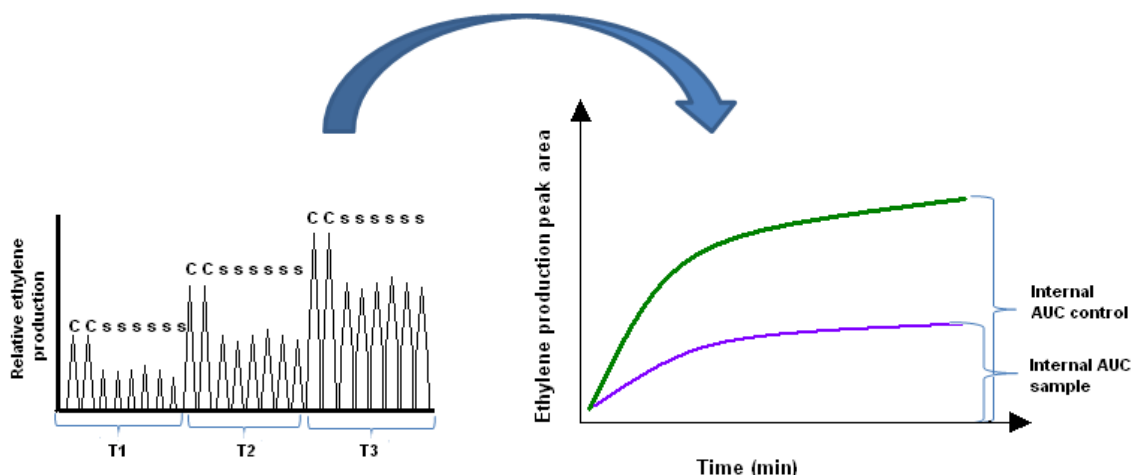

Figure 8: TOSC assay data out put from the gas chromatogram. Each peak represents one injection of ethylene from the head space of the samples. Ethylene production peaks are converted to kinetic curves, allowing integration of area under the curve (AUC) for sample and control.

TOSC values were quantified based on the difference of ethylene production between control (absence of antioxidant) and samples (including biological tissue) to out rule small variations in instrumental sensitivity or reagents. The area under the kinetic curves for the sample (SA) and control (CA) is used to calculate TOSC values according to the equation:

$$\text{TOSC} = 100 - \left(\frac{\text{SA}}{\text{CA}} * 100 \right)$$

Further more the TOSC values were related to the protein content of each individual by dividing the experimental TOSC to the protein concentration used in assay and presented as TOSC unit/ mg protein. Analysis was conducted in accordance to Winston (Winston et al. 1998) and Regoli (Regoli et al. 1999).

2.10 Chemical analysis

2.10.1 Chemicals and standards

All chemical analyses followed international requirements for quality assurance and control (QA/QC), e.g., recommendations of the Arctic Monitoring and Assessment Programme (AMAP) and the requirements in the European quality norm EN 17049. The analysis was performed by NILU. The samples were analyzed for PBDEs, chlordanes, DDTs and PCBs

(22 congeners) and their MeSO₂-PCBs metabolites (15 congeners), and 3-MeSO₂-DDE. Only the analytes which were detected above the detection limit are presented in tables and figures. Isotope dilution method was using ¹³C internal standards and surrogate standard for the analysis of MeSO₂ PCBs.

Extraction and clean-up of PBDEs, PCBs, DDTs, chlordanes and MeSO₂ PCBs in plasma samples were done as described: 2 ml of plasma sample was transferred to 15 ml glass tubes and 2 ml purified water with formic acid and 10 µl ¹³C-labeled internal standard mixture. Samples were then vortexed for 2 minutes. The plasma samples were later extracted on an Oasis HLB (540 mg; Waters Corp.) solid phase extraction column on the Zymark Rapidtrace. Further clean-up and fractionation was carried out on a Zymark Rapidtrace Automated SPE workstation (Zymark Corp.) using columns packed with 1 g Florisil (Alltech) based on a method by Sandanger (Sandanger et al. 2007). Three fractions were collected: Fraction 1: 7.2 ml of dichloromethane/n-hexane (1/4 v/v) as the eluting solvent containing neutral compounds, fraction 2: 9 ml acetone/n-hexane (1/10 v/v) containing MeSO₂ PCBs and finally fraction 3: 15 ml methanol/dichloromethane (1/5 v/v) containing the HPCs. The third fraction was evaporated to dryness and derivatized using 1 ml of diazomethane in n-hexane. A final clean-up was performed on the Zymark Rapidtrace using a column of 0.7g of 25% sulfuric acid silica with 0.2 g neutral silica on top and extracted using 8 ml of dichloromethane. Evaporation steps were performed on a Zymark RapidVap. One method blank were run for each sample set (10) and standard reference material consisting of human serum (NIST SRM 1589a), were run for quality assurance and control for parent compounds. All plasma extracts were transferred to GC vials with 150 µl inserts and isooctane were added before a gentle evaporation with nitrogen gas to the final volume and finally the addition of 10 µl octachloronaphtalene as recovery standard.

Lipid content was determined enzymatically and total amounts of lipids were calculated according to the following equation:

$$\mathbf{TL = 1.677(TC - FC) + FC + TG + PL}$$

where TL = total lipids, TC = total cholesterol, FC = cholesterol, TG = triacylglycerol and PL = phospholipids (Akins et al. 1989).

2.10.2 Quantification by GC/MS

The analysis of the compounds were performed by high-resolution gas chromatography (HRGC) on an Agilent 7890A gas chromatograph (GC) equipped with an Agilent 7683B automatic injector and an Agilent 5975C mass spectrometer (MS) (Agilent, Folsom, CA). The GC was fitted with a 30 m DB-5 MS column (5% phenyl-methylpolysiloxane; 0.25 mm i.d., 0.25 mm film thickness) from J&W Scientific (CA, USA). Splitless injection of 1 μ l aliquot of the sample extract and helium as a carrier gas at a constant flow of 1.5ml/min. Temperature program was as followed: initial temperature 70°C (2 min), 15°C/min to 180°C, 5°C/min to 280°C (5 min). The MS was running in the negative ion chemical ionization mode (NICI) for the metabolites and in EI for PCBs and DDTs, the instrument was operated in single ion monitoring mode (SIM). PBDEs were analyzed with HRGC/HRMS in EI mode.

2.11 Statistical processing

Statistical analysis was performed using open source software R (<http://cran.r-project.org>), using the results from different analysis as response variables to test the significance of difference between the groups or species within one treatment. The distributions were tested for normality and homogeneity with Shapiro test and Fligner-Killeen test, respectively. Data that fulfilled the two assumptions above were analysed with analysis of variance (One-way anova, $p < 0.05$). The non-normally distributed data were run with the non-parametric Wilcoxon rank-sum test for the paired data sets.

3 Results

3.1 *Assessment of the species-specific antioxidant defences*

The species individual means and standard deviations of all the assays on common eider, kittiwake and northern fulmar are summed up in table 4 of appendix. The box plot summarizes information about the datasets. The horizontal line is the median value for each species, the bottom and top of the box show the 25th and 75th percentiles, respectively (contains the middle 50% of the data). The whiskers show maximum and minimum value of the dataset. U/mg protein means $\mu\text{mol}/\text{min}/\text{mg}$ protein.

3.1.1 *Catalase*

Mean catalase activity of common eider, kittiwake and northern fulmar was 30.71, 19.92 and 24.72 $\mu\text{mol}/\text{min}/\text{mg}$ proteins, respectively (table 4, appendix). Kittiwake was found to have significantly lower catalase activity (ANOVA: $p\text{-value}<0.005$) than common eider when removing outliers. A total of 3 individuals were observed as extreme outliers. A reason for the strongly deviating numbers could be pipette error during assay measurements. Box plot of the data used in the statistical analysis are visualised in figure 9. Common eider was found to have approximately three times greater variation in the dataset than the other species.

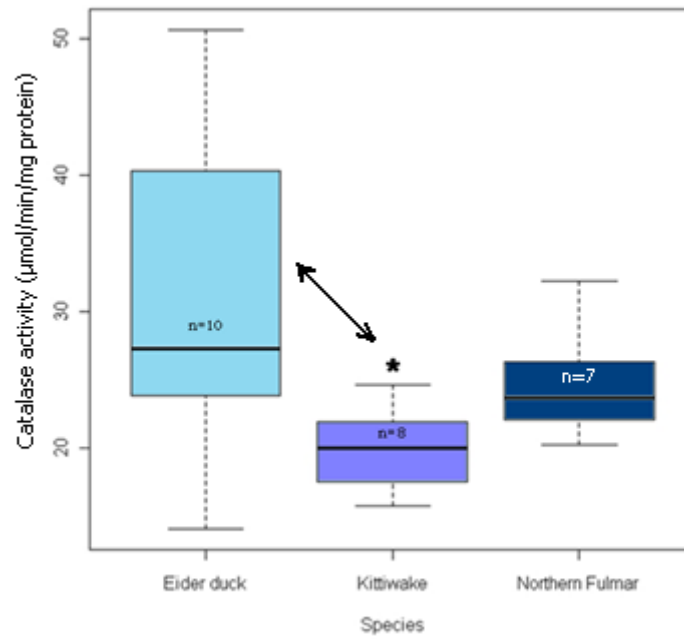

Figure 9: Catalase activity in kidney tissue from common eider (*Somateria mollissima*), kittiwake (*Rissa tridactyla*) and northern fulmar (*Fulmaris glacialis*) collected in Kongsfjorden, Svalbard 2009. The values are expressed as $\mu\text{mol}/\text{min}/\text{mg}$ protein (median values, +/- max/min value, 3 extreme outliers removed). Asterisks indicate significantly different from the common eider ($p < 0.05$, ANOVA).

3.1.2 Glutathione reductase

The mean GR activity of common eider, kittiwake and northern fulmar were 18.93, 16.96 and 27.97 $\mu\text{mol}/\text{min}/\text{mg}$ proteins, respectively (table 4, appendix). One-way ANOVA was chosen as statistical model because the dataset fulfilled the criteria: normal distribution and homogeneity in the residuals. The GR activity of northern fulmar was found to be significantly different from the other species (ANOVA: $p < 0.05$). Box plot (figure 10) shows the data set overview.

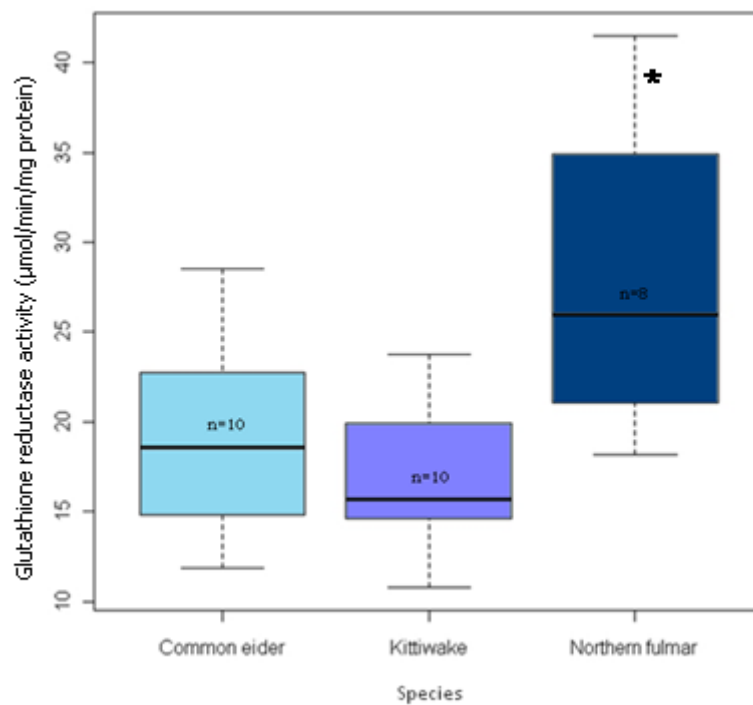

Figure 10: Glutathione reductase activity in kidney tissue from common eider (*Somateria mollissima*), kittiwake (*Rissa tridactyla*) and northern fulmar (*Fulmaris glacialis*) collected in Kongsfjorden, Svalbard 2009. The values are expressed as $\mu\text{mol}/\text{min}/\text{mg}$ protein (median values, +/- max/min value). Asterisk indicate significantly different from the other species ($p < 0.05$, ANOVA).

3.1.3 GPX

The mean Selenium independent GPX activity of common eider, kittiwake and northern fulmar were 33.76, 46.12 and 48.11 $\mu\text{mol}/\text{min}/\text{mg}$ proteins, respectively (table 4, appendix). Wilcoxon was chosen as statistical model because the dataset was not normally distributed, but had homogeneity of the residuals. None of the species selenium independent GPX activity was found to be significantly different from another (Wilcoxon: $p>0.05$). Two outliers are removed from the box plot (figure 11). This did not change the outcome of the statistical analysis. Both kittiwake and northern fulmar had respectively six times and four times higher variation in the dataset than common eider.

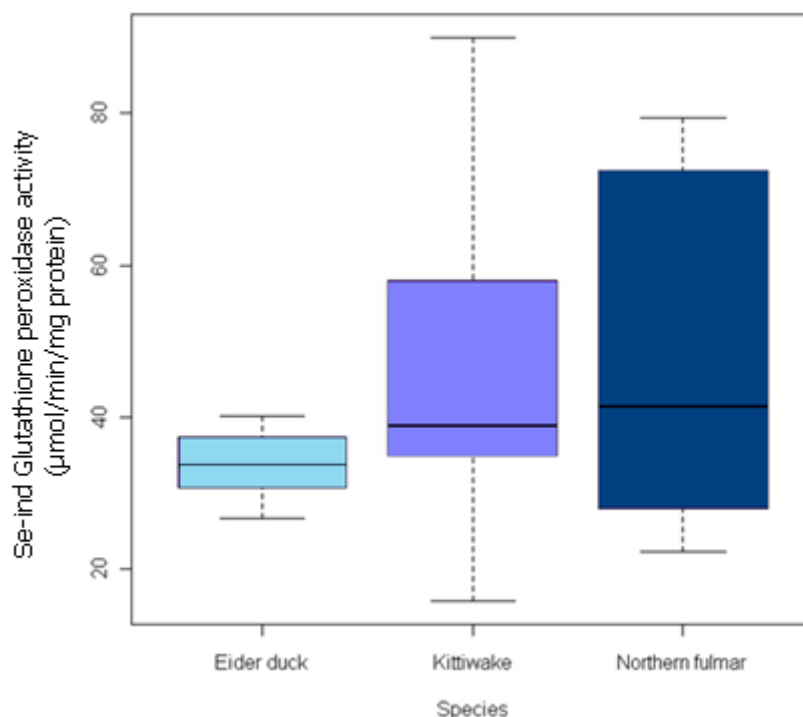

Figure 11: Selenium independent glutathione peroxidase activity in kidney tissue from common eider (*Somateria mollissima*), kittiwake (*Rissa tridactyla*) and northern fulmar (*Fulmarus glacialis*) collected in Kongsfjorden, Svalbard 2009. The values are expressed as $\mu\text{mol}/\text{min}/\text{mg}$ protein (median values, +/- max/min value). All groups are $n=8$.

The mean Selenium dependent GPX activity of common eider, kittiwake and northern fulmar were 75.48, 89.15 and 162.48 $\mu\text{mol}/\text{min}/\text{mg}$ proteins, respectively (table 4, appendix). One-way ANOVA was chosen as statistical model because the dataset fulfilled the criteria: normal distribution and homogeneity of the residuals. Northern fulmar revealed to be significantly different in selenium dependent activity from each other (ANOVA: $p < 0.05$). Four outliers were removed from the box plot (figure 12). Northern fulmar display two times as high variation in the dataset compared to the other species.

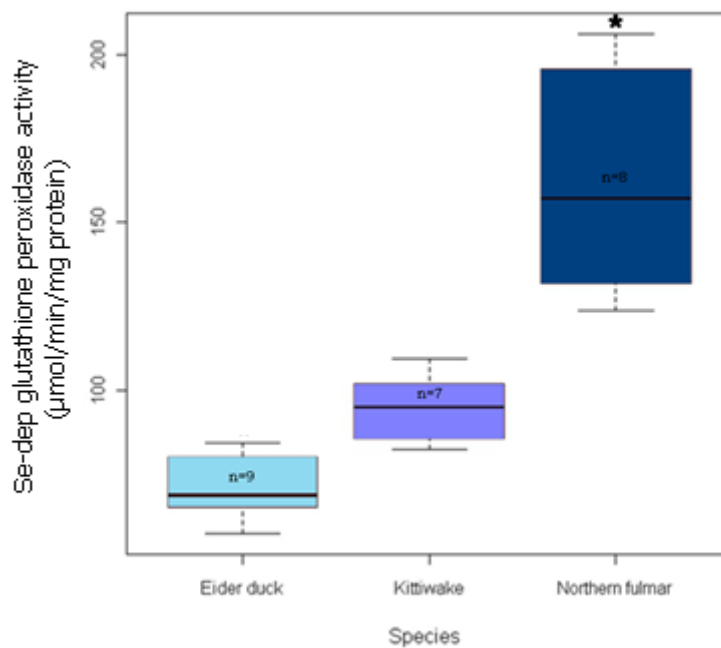

Figure 12: Selenium dependent glutathione peroxidase activity in kidney tissue from common eider (*Somateria mollissima*), kittiwake (*Rissa tridactyla*) and northern fulmar (*Fulmarus glacialis*) collected in Kongsfjorden, Svalbard 2009. The values are expressed as $\mu\text{mol}/\text{min}/\text{mg}$ protein (median values, +/- max/min value, extreme outliers removed). Asterisks indicate significantly different from the other species ($p < 0.05$, ANOVA).

3.1.4 Total glutathione levels

The mean total GSH levels of common eider, kittiwake and northern fulmar were 55.14, 58.38 and 124.78 $\mu\text{M}/\text{mg}$ proteins, respectively (table 4, appendix). One-way ANOVA was chosen as statistical model because the dataset fulfilled the criteria: normal distribution and homogeneity of the residuals. Northern fulmar show a significantly increased total GSH concentration compared to the other species (ANOVA: $p < 0.05$). One outlier was removed from the northern fulmar when run through the statistical tests, because of its extreme deviation (value=384.78) from the mean. However it did not affect the outcome of the ANOVA model. The dataset used when processing the statistics are displayed in figure 13.

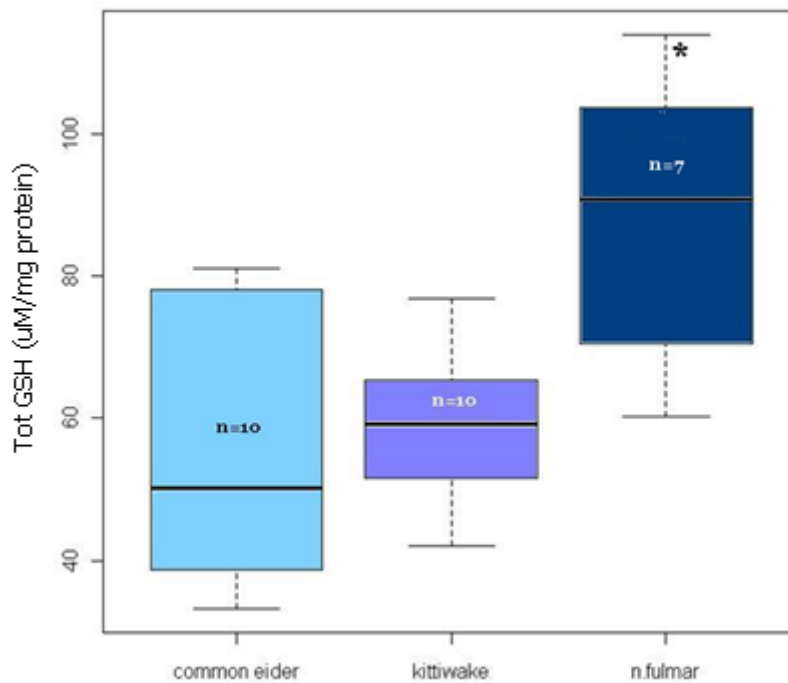

Figure 13: Total GSH levels in kidney tissue from common eider (*Somateria mollissima*), kittiwake (*Rissa tridactyla*) and northern fulmar (*Fulmarus glacialis*) collected in Kongsfjorden, Svalbard 2009. The values are expressed as concentration ($\mu\text{M}/\text{mg}$ protein) (median values, +/- max/min value, one extreme outlier removed). Asterisks indicate significantly different from the other species ($p < 0.05$, ANOVA).

The mean ratio GSH/GSSG levels of common eider, kittiwake and northern fulmar were 4.54, 3.89 and 5.36, respectively (table 4, appendix). One-way ANOVA was chosen as statistical model because of the dataset fulfilled the criteria: normal distribution and homogeneity of the residuals. No significant difference was revealed in ratio GSH/GSSG levels of the three species (ANOVA: $p < 0.05$). One outlier was removed from the northern fulmar when run through the statistical tests, because of its extreme deviation (value=384.78) from the mean. However it did not affect the outcome of the ANOVA model. The dataset used when processing the statistics are displayed in (figure 14).

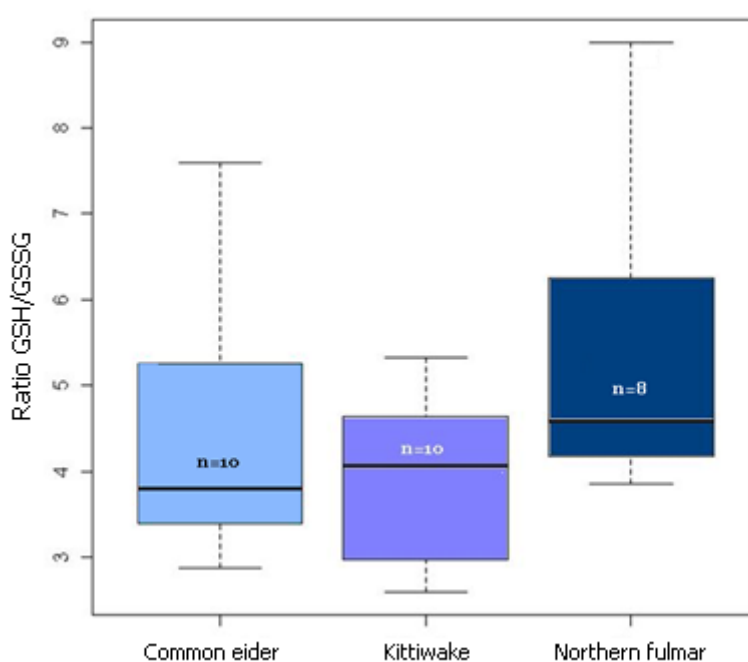

Figure 14: Ratio of GSH/GSSG levels in kidney tissue from common eider (*Somateria mollissima*), kittiwake (*Rissa tridactyla*) and northern fulmar (*Fulmarus glacialis*) collected in Kongsfjorden, Svalbard 2009. The values are expressed as concentration ($\mu\text{M}/\text{mg}$ protein) (median values, +/- max/min value).

3.2 Experimental analysis

This experiment had three cases of mortality among the experimental birds (total of 37 individuals), however this was not a result from the exposure it self. The deceased birds belonged to both exposure and control group and died before sampling time had begun. Only eight individuals per treatment group were used for tissue analysis, due to time limitations.

3.2.1 Chemical analysis of HOCs

The full list of chemicals and concentrations are put in table 2. The group values for the different assays are listed in table 5 of appendix. In herring gull kidney samples analysis detected PCB, DDT, MeSO-PCB, OH-PCB, OH-BDE and chlordanes (ng/g wet weight). . The control group had the lowest mean concentration of all chemicals analysed followed by fasted group < exposed < exposed+fasted group in an increasing manner (table 2). However, plasma lipid levels are displaying the opposite trend, with highest mean percentage in the control group (1.24%) followed by the fasted group (1.20%), exposed group (1.04%) and the exposed+fasted group (0.86%) (table 2).

Table 2: Sum PCB (22 congeners), DDT, Chlordane, MeSO PCB, OH PCB and OH BDE levels in plasma from herring gull (*Larus argentatus*) chicks collected on Sommarøy, Northern Norway 2008. The different treatment groups were fed herring and fish oil (clean or contaminated) until capable to flight. The values are expressed as mean (ng/g ww), standard deviation (SD) and numbers of individuals over minimum detection level (N>MDL).

ng/g ww	Control			Fasted			Exposed			Exposed+Fasted		
	Mean	SD	N>MDL	Mean	SD	N>MDL	Mean	SD	N>MDL	Mean	SD	N>MDL
∑PCB	6.65	2.69	8.00	14.39	8.61	8.00	144.75	41.77	8.00	743.34	477.14	8.00
∑DDT	2.39	1.00	8.00	5.14	2.76	8.00	50.09	18.66	8.00	176.40	135.87	8.00
∑Chlordanes	0.55	0.13	8.00	1.59	0.89	8.00	13.12	8.70	7.00	50.42	24.53	8.00
∑MeSO PCB	0.03	-	1.00	0.15	0.03	4.00	0.87	0.37	7.00	16.42	0.37	8.00
∑OH-PCB	0.25	0.19	8.00	1.43	3.05	8.00	6.57	3.55	8.00	19.37	8.24	8.00
∑OH-BDE	-	-	0.00	-	-	0.00	0.03	0.02	2.00	0.05	0.04	7.00
% Lipids	1.24	0.17	8.00	1.20	0.23	8.00	1.04	0.12	8.00	0.86	0.21	8.00

There was a significant difference in sum PCB (log transformed) levels of all treatment groups except of control group and fasted group (table 6 in appendix). Figure 15 displays the sum PCB accumulated in plasma of the different treatment groups and figure 16 display the three most abundant contaminant levels.

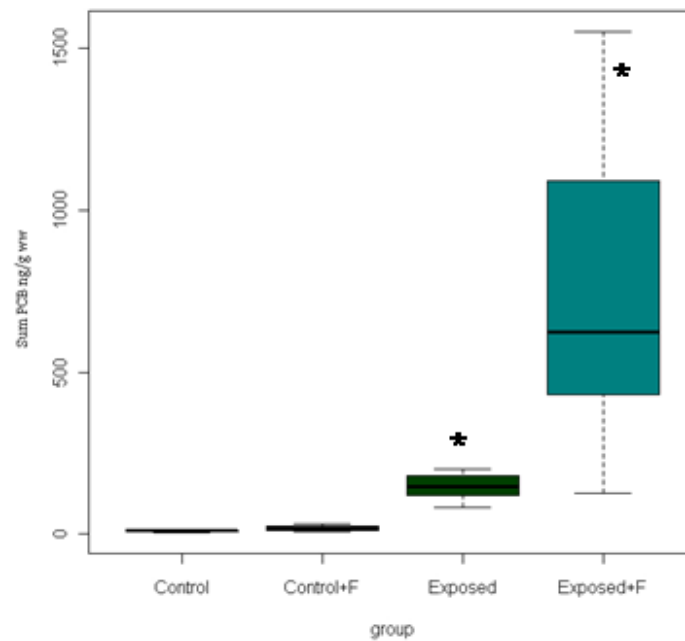

Figure 15: Sum PCB levels in four treatment groups of herring gull chicks collected outside Sommarøy, northern Norway 2008. The letter F represents fasted birds. Asterisks indicate significantly different from the other species ($p < 0.05$, ANOVA).

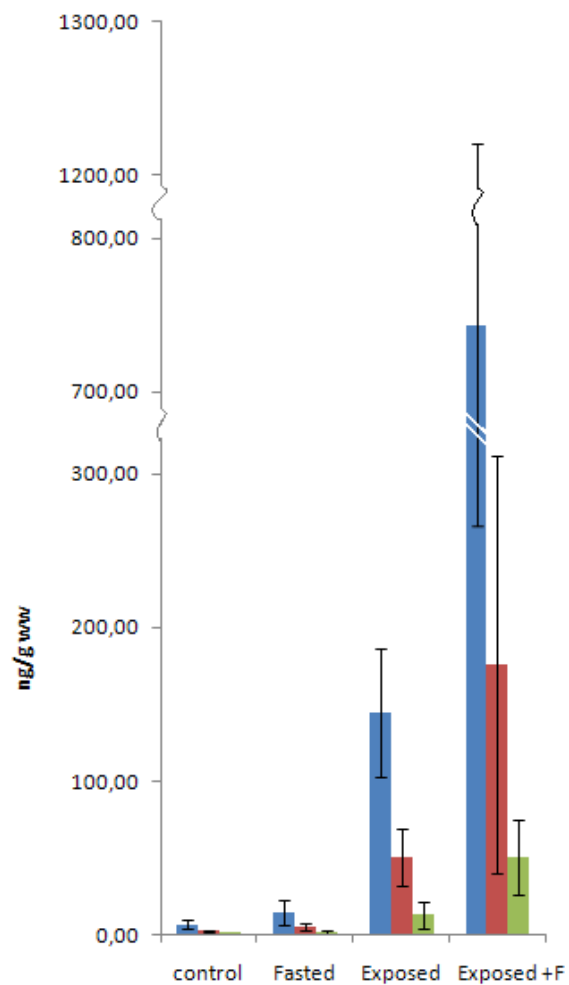

Figure 16: Sum PCB (blue), DDT (red) and chlordanes (green) levels of the four treatment groups of herring gull chicks collected outside Sommarøy, northern Norway 2008. The letter F represents fasted birds.

3.2.2 Hydroxyl radicals

The mean TOSC-OH of control, fasted and exposed, exposed+fasted (E+F) and reference group were 745.66, 598.76, 545.04, 726.84 and 1179.85 TOSC unit/mg proteins, respectively (table 5, appendix). One-way ANOVA was chosen as statistical model because the dataset fulfilled the criteria: normal distribution and homogeneity of the residuals. Fasted group and exposed group revealed to have a significantly lower capacity towards OH than the control group (ANOVA: $p < 0.05$). Three outliers were removed from the dataset for statistical analysis, based on their extreme values. However it did not affect the outcome of the ANOVA model. The dataset used when processing the statistics are displayed in figure 17. The variation of the exposed+fasted group is at least twice the variation of the other groups.

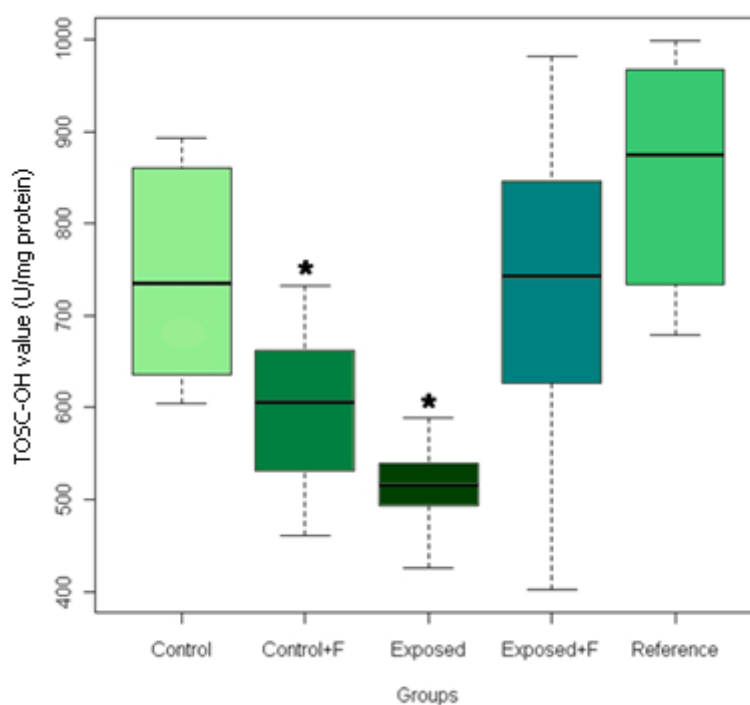

Figure 17: Total oxyradical scavenging capacity towards hydroxyl radical from kidney tissue from herring gull (*Larus argentatus*) chicks collected on Sommarøy, Northern Norway 2008. The different treatment groups were fed herring and fish oil (clean or contaminated) until capable to fly. The values are expressed as TOSC units/ mg protein (median values, +/- max/min value, extreme outliers removed, n=8 for all except the exposed group n=7 and the reference group n=6). Asterisks indicate significantly different value compared to the control ($p < 0.05$, ANOVA). The letter F represents fasted birds.

3.2.3 Peroxynitrite

The mean TOSC-NOO of control, fasted and exposed, exposed+fasted (E+F) and reference group were 1094.70, 1054.71, 1039.90, 1426.93 and 1347.12 TOSC unit/mg proteins, respectively (table 5, appendix). One-way ANOVA was chosen as statistical model because the dataset fulfilled the criteria: normal distribution and homogeneity of the residuals. E+F group and reference group revealed to have a significantly higher capacity towards NOO than the control group (ANOVA: $p < 0.05$). One outlier was removed from the dataset for statistical analysis, based on its extreme value. However it did not affect the outcome of the ANOVA model. The dataset used when processing the statistics are displayed in figure 18.

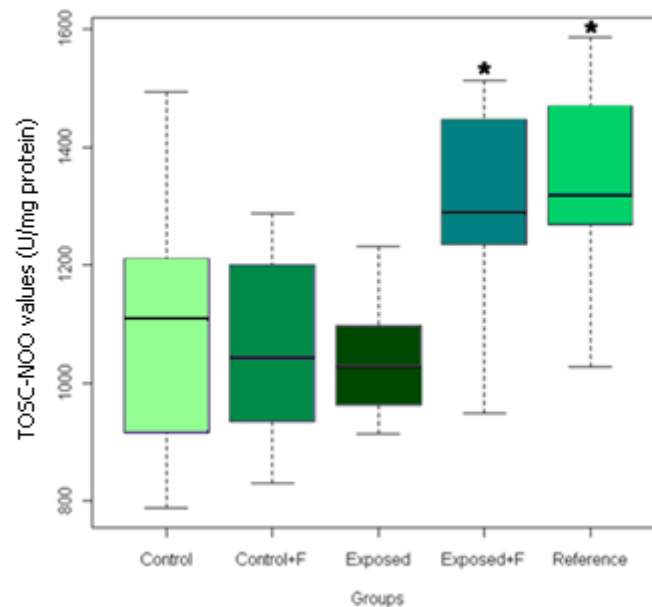

Figure 18: Total oxyradical scavenging capacity towards peroxynitrite from kidney tissue from herring gull (*Larus argentatus*) collected on Sommarøy, Northern Norway 2008. The different treatment groups were fed herring and fish oil (clean or contaminated) until capable to fly. The values are expressed as TOSC units/ mg protein (median values, +/- max/min value, extreme outliers removed, n=8 for all except the fasted group n=7). Asterisks indicate significantly different value compared to the control ($p < 0.05$, ANOVA). The letter F represents fasted birds.

3.2.4 Peroxyl radicals

The mean TOSC-ROO of control, fasted and exposed, exposed+fasted (E+F) and reference group were 571.07, 518.23, 468.32, 736.82 and 542.37 TOSC unit/mg proteins, respectively (table 5, appendix). One-way ANOVA was chosen as statistical model because the dataset, when log transformed, fulfilled the criteria of normal distribution and homogeneity of the residuals. E+F group revealed to have a significantly higher capacity towards ROO than the control group ($p < 0.05$, ANOVA). The dataset used when processing the statistics are displayed in figure 19.

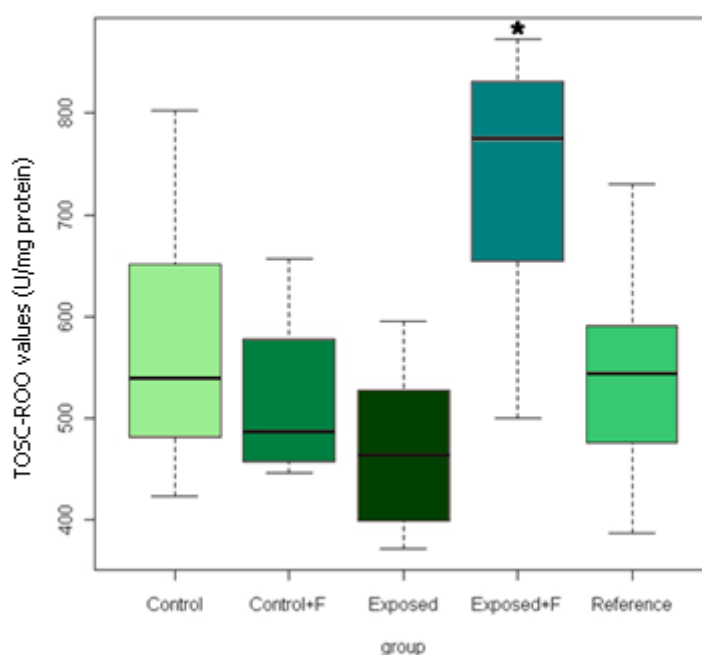

Figure 19: Total oxyradical scavenging capacity towards peroxy radicals from kidney tissue from herring gull (*Larus argentatus*) collected on Sommarøy, Northern Norway 2008. The different treatment groups were fed herring and fish oil (clean or contaminated) until capable to fly. The values are expressed as TOSC units/ mg protein (median values, +/- max/min, $n=8$). Asterisk indicates significantly different value compared to the control ($p < 0.05$, ANOVA). The letter F represents fasted birds.

3.2.5 Relationships between PCB concentration and TOSC value

The relationship between antioxidant capacity and levels of PCB was calculated using two and two groups to out rule any confounding factors. Even with only two different treatments (exposed and fasted) there can be a misinterpretation of the statistical model if all groups are put together. In addition all groups were run one by one to make sure there was no internal

relationship. Sum PCB and TOSC towards NOO was positively related in fasted group and the exposed+fasted group, but the relationship is very weak (adj r^2 = 0.20, slope = 0.06) (table 3). In contrast sum PCB and TOSC towards HO were negatively related in the control and exposed group. Sum PCB and TOSC towards ROO were positively related in two comparisons, control vs exposed+fasted and fasted vs exposed+fasted, although the relationship was very weak for the first (adj r^2 = 0.22, slope = 0.05). Data from linear regression testing relationship between the treatment groups are summed up shortly in table 3, further details are shown in Table 7.

Table 3: Regression relationship between log transformed PCB level and log transformed TOSC level of two treatment groups of herring gull (*Larus argentatus*) collected at Sommarøy, Troms summer 2008. The different treatment groups were fed herring and fish oil (clean or contaminated) until capable to fly. The values highlighted are significantly correlated ($p < 0.05$), the slope reveals positive or negative correlation and the adjusted r^2 gives an estimate of how well the data plots fit with the respective slope. E+F means exposed+fasted group.

		ONOO	HO	ROO
Control vs Exposed	Slope	-0.02	-0.12	-0.06
	adj r2	-0.04	0.52	0.15
Control vs E+F	Slope	0.05	-0.02	0.05
	adj r2	0.11	-0.04	0.22
Fasted vs Exposed	Slope	0.01	-0.07	-0.02
	adj r2	-0.07	0.17	-0.04
Fasted vs E+F	Slope	0.06	0.03	0.09
	adj r2	0.20	-0.02	0.49

4 DISCUSSION

4.1 *Assessment of the species-specific antioxidant defences*

The single antioxidant parameters offer information on the defence mechanism changes related to the presence of reactive oxygen species in the cell. The parameters chosen for this study are key antioxidant defence parameters of bird's cells or any animals for scavenging deleterious reactive species (Regoli 2000; Tarpey et al. 2004). Their relative background activity levels are known to be species-specific as they reflect the oxidative metabolism which depends on many fundamental biological features such as feeding status, aerobic scope, reproduction status etc. Seabird's antioxidant defence in kidney tissue has to our knowledge not been investigated to this date and the antioxidant system of seabird's kidney tissue is not documented. However, several studies on antioxidant defences have been performed on avian species in blood plasma (Galvani et al. 2000; Corsolini et al. 2001; Isaksson et al. 2005; Isaksson et al. 2007) and liver (Mateo et al. 2001; Berglund et al. 2007; Isaksson et al. 2009). Nevertheless, the antioxidant system in kidney has been reported in rats and voles (Selman et al. 2000; Kaushik et al. 2003). Thus in this study, the values has to be compared to either birds liver or rats and voles kidney antioxidant values.

The catalase enzyme is widely distributed through all cells of the body. The role of Catalase is to decompose hydrogen peroxide (H_2O_2), a product of superoxide dismutation and peroxisomal enzyme activity. This results in a termination of a potential reactive cascade by decomposing H_2O_2 to water and oxygen. The mean catalase activity levels (19-31 U/mg protein) measured in kidney of all three species considered in this study are above the range of rat kidney levels (15 U/mg protein) (Kaushik et al. 2003), but lower than voles kidney tissue (1,2 kU/mg protein) (Selman et al. 2000) flycatcher liver levels (180 kU/mg protein) (Berglund et al. 2007) and great tits liver levels (300 kU/mg protein) (Isaksson et al. 2009). The two latter studies use the cytosol fraction of the homogenate instead of S9 fraction. The cytosol fraction has a higher activity level than S9 fraction and is therefore not ideal for comparison. However it gives a certain estimate of where the values are.

Within bird species, it can be noted that, similarly to the study of arctic seabird chicks by Hegseth et al. (2010) the kittiwake had a reduced catalase activity compared to the other arctic seabirds. This indicates that the kittiwake has a less effective H_2O_2 decomposing catalase enzyme.

Glutathione peroxidase (GPX), similarly to catalase, decomposes H_2O_2 , but by reducing a NADPH molecule (figure 7). This process oxidises reduced glutathione (GSH) and form GSSG, which is a selenium dependent process. Another antioxidant feature of the GPX enzymes, the selenium independent GPX, are the capability to reduce fatty acid hydroperoxides (ROOH) to water and lipid alcohol (ROH), thus protecting the cell membranes from lipid oxidation. Total mean GPX levels (108-210 U/mg protein) from this study (Se-dep+Se-indep) are similar compared to rat kidney tissue (91 U/mg protein) (Scott et al. 2000), but elevated compared to flycatcher liver levels (57 mU/mg protein) (Berglund et al. 2007), liver levels of canada goslings (267 mU/mg protein) and mallard ducklings (342 mU/mg protein) and broiler chicks (2198 mU/mg protein) (Mahmoud et al. 2003). Interestingly, these studies reveal a specific antioxidant mechanism. Indeed, these studies show that to an elevated catalase activity corresponds a low GPX activity. There is a biological trade off between catalase and GPX to scavenge H_2O_2 . Surprisingly, this is in contradiction to our study, where all seabirds investigated show much higher values for se-dependant GPX activity than for catalase activity. Considering that the bird species investigated are located on top of the food chain, this finding supports the statement of McCord (2000) that the antioxidant system of higher organisms are characterised by a low catalase activity and a high GPX activity. The two enzymatic processes overlap in function, but the GPX system is much more advanced due to its capability to reduce hydrogen peroxide as well as lipid peroxides and thereby maintaining the structure and function of cell membranes.

High concentrations of glutathione are generally found in almost all cells. To assess the effect of the glutathione complex (figure 7), it is of importance to measure not only the activity levels of glutathione reducing/oxidising enzymes but also to quantify the amount of GSH and the ratio of GSH/GSSG, a sensitive index of oxidative stress. If the ratio is skewed towards oxidised glutathione, it indicates a poor intracellular oxidative state and a higher saturation of the glutathione complex by reactive oxygen species. The GSH/GSSG ratio levels measured of common eider, kittiwake and northern fulmar are even (3.89-5.36), and above kidney values of rat (2.95) (Scott et al. 2000), plasma levels of adult urban great tits (1.2) (Isaksson et al. 2005) blood levels of Japanese quail (1.2) (Galvani et al. 2000). The cited data rats/birds indicate that the rats cell are in reduced state and that the birds cell are more exposed to oxidative stress. Glutathione reductase (GR) require one molecule of NADPH to reduce oxidised glutathione (GSSG) to gain two GSH, which can again act as a scavenger of reactive

oxygen species in the cell. The GR activity levels (16.96-27.97 U/mg protein) in kidney of the seabirds measured are higher than liver tissue levels from broiler chicks (187 mU/mg protein) (Mahmoud et al. 2003), mallard ducklings (103 mU/mg protein) and canada goslings (68 mU/mg protein) (Mateo et al. 2001) and liver levels measured in flycatcher (17 mU/mg protein) (Berglund et al. 2007), but lower than rat kidney levels (132 U/mg protein) (Scott et al. 2000). The northern fulmar showed to have higher GR activity than common eider and kittiwake. This means that the northern fulmar is more efficient in the turnover of GSSG→GSH, and subsequently should have a higher GSH/GSSG ratio compared to the other species. This is confirmed by the elevated level of GSH/GSSG ratio for northern fulmar, although not significantly higher than the other species.

In the last decade, differences in antioxidant defence system have been related to the oxidative status at the different life stages, time of year, migratory pattern, diet, gender and health in general (Costantini 2008; Cohen et al. 2009). The individuals collected for this study are mainly adult, non-breeding individuals, but of different sexes. The kittiwakes consist of only males, whereas the common eiders are represented by all females except for one individual while the northern fulmars are evenly represented of both sexes. Northern fulmar was tested to see if there was any gender specific difference and revealed no significant different values. Because of too few individuals (3 males + 3 females + 2 unknown), the samples of this study are not suited to say anything about such trends. Owing to the limited permit delivered by the authorities to collect only 10 birds per species, the effect of sex on the background levels of the antioxidant parameters selected in this study could not be investigated. This remains to be elucidated in the future.

Migratory birds might have periods of high production of reactive species, during their seasonal relocation. Although the common eider is a highly migratory bird with great body mass (Bustnes et al. 2000), it is rarely flying during mid summer (which was the sampling time of this study). Moulting is the most energetic process at this time of year, but this state was not observed for the birds sampled. One can therefore assume that the common eider had a relative low metabolic rate. The data support this assumption since relatively low activity of the parameters of the GSH complex was reported. Kittiwakes on the other hand displayed relatively low antioxidant activities, despite its resting high metabolic rate and high flying intensity (Gabrielsen et al. 1987; Barrett et al. 2000). A high metabolic rate is thought to increase respiratory stress and free radical formation as a by-product through the electron transport chain (Cohen et al. 2008). Kittiwakes had a significantly reduced catalase activity

compared to the others. However, the analysis of se-dependent GPX showed to have elevated levels of activity compared to common eider, suggesting that kittiwake supplement poor catalase activity with elevated GPX activity. This might support the theory of individual different strategies to cope with reactive species (Helmut 1993). In that context, common eiders show a slightly different strategy than kittiwake and to some degree northern fulmar, with relative low value of GPX activity, total glutathione levels and GR activity. Compared to kittiwake, northern fulmar is a less migratory bird, has less energy consumption, higher lipid storage, but relatively similar diet (Gabrielsen et al. 1988; Bakken et al. 2000). Our study of the antioxidant parameters shows that northern fulmar also differs in antioxidant activities. It displayed an elevated activity of se-dependent GPX, GR and total [GSH] compared to common eider and kittiwake as well as higher activity of catalase than the kittiwake. It is a contradiction to the theory of birds having an efficient antioxidant system to compensate for great free radical production due to elevated metabolic rate (Costantini 2008), considering the low energy consumption of the species (Furness et al. 1996). To conclude, northern fulmar antioxidant defence system is characterised by a high capacity to scavenge free radicals using the GSH complex.

Longevity is positively associated with a highly protective antioxidant defence system (Munshi-South et al. 2010). Birds are relatively long-lived compared to other species of similar size. The energy expenditure of flying requires high fuel supply such as oxygen. Because of the high aerobic scope, birds must have an elevated antioxidant defence to cope with the potentially elevated production of reactive oxygen species during flying activity. It is a mystery how birds can be so long-lived compared to their metabolic expenditure and body size. The link between species maximum ages, aerobic scope and oxidative mechanisms is difficult to elucidate (Costantini 2008). However, the results from this study points towards the above theory that long lived species are characterized by high antioxidant defence system, especially when comparing the enzymatic activity of se-dependant GPX and total glutathione of the three birds investigated. Kittiwakes and common eider exhibit a much lower overall antioxidant activity than northern fulmar. Figure 12 and figure 13 display activity levels that fit the increasing maximum age observed for the birds, with common eider and kittiwake being the least long-lived (24 and 19 years, respectively) and northern fulmar being the most long lived (50 year).

4.2 Quantification of HOC exposure-mediated formation of free radicals

4.2.1 Contaminant levels

In contrast to the control group fed with clean fish oil, the exposure group was fed with concentrated fish oil from herring known to naturally contain high levels of PCBs. This was done to use a “natural” mixture of contaminants rather than making an artificial mixture of PCBs. The treatment resulted in twenty times higher Σ PCB levels in the exposure group compared to the control group at the end of the exposure period. The Σ PCB levels of plasma show that fasting increased mobilisation of the lipophilic compounds of the control group and the exposure groups, thus increasing the contaminant stress in the birds. Indeed, fasting resulted in doubling the Σ PCB levels in the control group, while fasting and exposure (E+F) resulted in hundred times more elevated Σ PCB values compared to the control. The values of exposed and E+F group are high above Σ PCB blood levels of free ranging great black-backed gull (95 ng/g ww) (Helberg et al. 2005) and lesser black-backed gull (28 ng/g ww) (Bustnes et al. 2008) from northern Norway, but less than liver levels of glaucous gull from Bear Island (20114 ng/g ww) and Northern Baffin Bay (1680 ng/g ww) (Borgå et al. 2005; Verreault et al. 2007). Hence, the levels of Σ PCB are in the same range as field levels measured in birds of the same trophic level, simulating realistic exposure levels. Due to limited amount of kidney tissue, it could not be analysed for contaminants. For this study on the antioxidant defence properties of the kidney, we decided to measure the HOC concentration in the blood plasma. Indeed, kidney's main function is to filter large volume of blood, which makes this organ highly susceptible to be exposed to PCBs present in the plasma. The complete HOC mix had a main contribution of PCBs, hence the Σ PCB was chosen as representative contaminant parameter.

4.2.2 Antioxidant capacity and relationship with PCB concentration

The TOSC assay allows measuring of the overall antioxidant capacity towards certain reactive species. The selected prooxidants for this study (OH, ROO and NOO) are highly reactive and can cause important damage to the cell constituents (DNA, enzymes, lipid etc.). Many studies have been conducted on TOSC of marine species, like bivalves, crustaceans, and fish (Regoli 2000; Regoli et al. 2000; Camus et al. 2002; Regoli et al. 2002; Camus et al. 2004). One study has been performed on the plasma of a few avian species (Corsolini et al. 2001), but not in relation to contaminant exposure. Therefore, no known earlier published results can be

compared to TOSC tissue levels of kidney tissue reported in this study. However, the liver TOSC values of herring gull chicks from 2007 have been measured in one study by Hegseth et al. (2010).

Animals exposed to HOCs showed a decreased scavenging capacity toward OH compared to the control group. The mean value of TOSC-NOO and TOSC-ROO of this group are slightly reduced, but not significantly. Similar physiological response has been observed in a study of fish exposed to dioxin by Regoli et al. (2002). A lowered mean TOSC value in these groups may indicate saturation of the antioxidant defenses to some extent and the difficulty for the cell to replenish the stock of reduced low molecular weight scavengers (Camus et al. 2002). Decreased TOSC-OH is also known to be correlated to severe biological effects such as destabilization of the membrane of the lysosomes in mussels and to an increased DNA damage (Regoli et al. 2002). The levels of TOSC-OH in herring gull compared to studies of scallops (Regoli et al. 2000) are quite similar. However, in mussels (Regoli 2000) the values are substantially lower (350 U/mg protein). This might be an effect of the high energy consumption of birds, leading to more intense free radical production and subsequently a greater defense system has evolved to maintain homeostasis. The mean levels for TOSC-OH in the kidney tissue is approximately the same as the mean liver levels of the same individuals (Hegseth et al. 2010). This indicates that the kidney tissue experiences as high exposure to OH radicals and has developed a sophisticated antioxidant defense to cope with it. This confirms that the blood filtering activity of the kidney makes this organ a good indicator for effects of contaminants. A negative correlation was found for TOSC-OH and Σ PCB level when looking at the exposure group and the control group, indicating a reduction of TOSC-OH scavenging capacity following an increasing contaminant burden. This is coherent with the research of mean TOSC-OH in liver tissue of the same species (Hegseth et al. 2010). We would therefore recommend TOSC-OH as an indicator of exposure to Σ PCB.

Simultaneous treatment of exposure to HOCs and fasting to animals was found to induce the TOSC-NOO and TOSC-ROO but not TOSC-OH. Therefore the antioxidant defence system responds differently to the PCB during fasting. During fasting, lipids and proteins stored in the body will be mobilized and catabolised to supply energy to the cell. Protein are nitrogen rich biomolecules, therefore, their catabolism will generate a high level of nitrogen which is necessary to form peroxyxynitrite. The combination of fasting and HOC exposure has triggered the antioxidant defense to increase its capacity to scavenge the reactive species. The mean levels for TOSC-NOO in kidney tissue are twice as high as mean levels for liver tissue of free

living herring gull chicks (Hegseth et al. 2010). This might be explained by the great occurrence of nitric oxide (as a messenger signal of blood regulation) in the kidneys. In addition, NO is a byproduct of arginine, an important component of the urea cycle, which after release to the bloodstream is continuously filtered by the kidneys. A positive correlation was found for TOSC-NOO and TOSC-ROO with Σ PCB level among E+F birds, although weak for TOSC-NOO. This implies that TOSC-NOO and TOSC-ROO are induced by Σ PCB during fasting. This may indicate that SOD and the glutathione system have been induced (Winston et al 1998; Regoli et al. 1999). In this case it would be really interesting to look at the single antioxidant parameters to see which could have contributed to the increased levels in the antioxidant capacity. Due to the small size of the kidney, the TOSC assay and the single antioxidant parameters could not be measured altogether. However, the TOSC assay provides a more holistic picture of the oxidative state and cell health. In our study, high inter individual variability was observed in the E+F group for TOSC-OH. The inter-individual variability might indicate effect of exposure (Depledge et al. 1996). This high variability in the response, indicate that some individuals have an induced TOSC while some have a reduced TOSC. It would have been more informative in this case to have a dose-effect relationship, by introducing different levels of doses. With higher doses the antioxidant defence system would have been either induced or repressed for all animals.

Reference group are wild living chicks collected from a different year (2007) than the chicks used for the experiment (2008). This makes them less comparable to the experimental group. They were initially included to reflect on the field validation of the experimental studies, although, they were not included in the toxicology analysis to avoid misinterpretation.

5 Conclusions

This is the first study to assess antioxidant systems in kidney tissue of arctic seabirds towards species-specific differences and levels of HOCs. The tools used to investigate this complex system are both single antioxidant parameters, useful as response biomarkers, and quantitative measurements, useful as effect biomarkers focusing on the whole antioxidant capacity.

This study reports the bird species differences on the antioxidant system among a selection of arctic seabirds from Kongsfjorden. Common eider, kittiwake and northern fulmar display different species-specific antioxidant strategies. Common eider had similar levels to kittiwake in all parameters except from catalase assay. The increase in catalase activity and a lower GPX (Se-dep) may indicate that this species has a slightly different antioxidant strategy than the other birds, relying more on the catalase system than the other species. Northern fulmar is characterized by a similar catalase activity, GPX (Se-indep) and glutathione ratio, but higher levels for GR, GPX (Se-dep) and glutathione levels than the other species investigated. Kittiwake's antioxidant system does not reflect its high metabolic rate and may therefore be more vulnerable to natural or anthropogenic influences in than other species. Although many biotic and abiotic (life stages, sex, seasonality, diet) can affect the antioxidant defence, this study revealed the importance to further study single antioxidant parameters to better understand bird's physiology. The experimental study using herring gull chicks exposed to PCB indicated that fasting had very different effect on the antioxidant defence response. Exposure only led to reduced capacity to scavenge OH. However, the combination of exposure and fasting resulted in increased scavenging capacity towards NOO and ROO, suggesting that new underlying mechanisms are induced to cope with the stressors. The overall levels for kidney antioxidant defences were relatively high compared to liver levels. TOSC-OH was negatively correlated to Σ PCB, demonstrating that this index can be used as biomarker of contaminants in birds. We conclude that antioxidant defences measured in kidney of seabirds are well suited as biomarkers of Σ PCB in the Arctic marine environment. Finally, this study demonstrated that parental transfer of HOCs via feeding of the chicks can lead oxidative stress in kidneys and potential adverse effects (ie. DNA damage, lysosomal membrane instability)

Top predators reflect the health of the ecosystem, giving early warning sign to changes in the environment. Most toxicity studies of HOCs or POPs to investigate biologic effect on arctic sea birds focus on contaminant relationship with different biological parameters (e.g., EROD and thyroid hormone)(Henriksen et al. 2000; Verreault et al. 2004). These studies do not rule

out the natural changes of the environment and also the biology of the animal, thus anthropogenic originated contaminants may not be the only cause of the measured effect. In this study we successfully investigated the effect of two parameters, exposure to PCBs and fasting and compared the data to a control group treated the exact same way as exposed birds.

6 References

- Aebi, H. and P. Lester (1984). [13] Catalase in vitro. Methods in Enzymology, Academic Press. **Volume 105**: 121-126.
- Akins, J. R., K. Waldrep and J. T. Bernert Jr (1989). "The estimation of total serum lipids by a completely enzymatic 'summation' method." Clinica Chimica Acta **184**(3): 219-226.
- AMAP (2004). Assessment 2002: Persistent organic pollutants in the arctic. Arctic monitoring and assessment programme (AMAP). S. J. Wilson and G. Packman. Oslo, Norway, AMAP: 21-31.
- AMAP (2009). Arctic pollution 2009. Arctic monitoring and assessment programme (AMAP). Oslo, Norway, AMAP: 1-34.
- Anker-Nilssen, T., V. Bakken, Y. Strom, A. N. Golovkin, V. V. Bianki and I. P. Tatarinkova (2000). The Status of Marine Birds Breeding in the Barents Sea Region. Tromsø, The Norwegian Polar Institute. **1**: 94-96.
- Baker, M. A., G. J. Cerniglia and A. Zaman (1990). "Microtiter plate assay for the measurement of glutathione and glutathione disulfide in large numbers of biological samples." Analytical Biochemistry **190**(2): 360-365.
- Bakken, V. and M. V. Gavrilov (2000). Northern fulmar. The Status of Marine Birds Breeding in the Barents Sea Region. T. Anker-Nilssen, V. Bakken, Y. Strom, A. N. Golovkin, V. V. Bianki and I. P. Tatarinkova. Tromsø, The Norwegian Polar Institute. **1**: 16-19.
- Barett, R. T. and G. M. Tertitski (2000). Black legged kittiwake. The Status of Marine Birds Breeding in the Barents Sea Region. T. Anker-Nilssen, V. Bakken, Y. Strom, A. N. Golovkin, V. V. Bianki and I. P. Tatarinkova. Tromsø, The Norwegian Polar Institute. **1**: 100-103.
- Berglund, Å. M. M., J. Sturve, L. Förlin and N. E. I. Nyholm (2007). "Oxidative stress in pied flycatcher (*Ficedula hypoleuca*) nestlings from metal contaminated environments in northern Sweden." Environmental Research **105**(3): 330-339.
- Borgå, K., H. Wolkers, J. U. Skaare, H. Hop, D. C. G. Muir and G. W. Gabrielsen (2005). "Bioaccumulation of PCBs in Arctic seabirds: influence of dietary exposure and congener biotransformation." Environmental Pollution **134**(3): 397-409.
- Bradford, M. M. (1976). "A rapid and sensitive method for the quantitation of microgram quantities of protein utilizing the principle of protein-dye binding." Analytical Biochemistry **72**(1-2): 248-254.
- Bredt, D. S. and S. H. Snyder (2003). "Nitric Oxide: A Physiologic Messenger Molecule." Annual Review of Biochemistry **63**(1): 175-195.
- Bustnes, J. O., K. E. Erikstad, S.-H. Lorentsen and D. Herzke (2008). "Perfluorinated and chlorinated pollutants as predictors of demographic parameters in an endangered seabird." Environmental Pollution **156**(2): 417-424.

Bustnes, J. O., K. E. Erikstad, J. U. Skaare, V. Bakken and F. Mehlum (2003). "Ecological effects of organochlorine pollutants in the Arctic: A study of the Glaucous Gull." Ecological Applications **13**(2): 504-515.

Bustnes, J. O. and G. M. Tertitski (2000). Common eider. The Status of Marine Birds Breeding in the Barents Sea Region. T. Anker-Nilssen, V. Bakken, Y. Strom, A. N. Golovkin, V. V. Bianki and I. P. Tatarinkova. Tromsø, The Norwegian Polar Institute. **1**: 46-50.

Camus, L. and B. Gulliksen (2004). "Total oxyradical scavenging capacity of the deep-sea amphipod *Eurythenes gryllus*." Marine Environmental Research **58**(2-5): 615-618.

Camus, L., M. B. Jones, J. F. Børseth, F. Regoli and M. H. Depledge (2002). "Heart rate, respiration and total oxyradical scavenging capacity of the Arctic spider crab, *Hyas araneus*, following exposure to polycyclic aromatic compounds via sediment and injection." Aquatic Toxicology **61**(1-2): 1-13.

Carlberg, I., B. Mannervik and M. Alton (1985). [59] Glutathione reductase. Methods in Enzymology, Academic Press. **Volume 113**: 484-490.

Cohen, A. A., M. Hau and M. Wikelski (2008). "Stress, metabolism, and antioxidants in two wild passerine bird species." Physiological and Biochemical Zoology **81**(4): 463-472.

Cohen, A. A. and K. J. McGraw (2009). "No simple measures for antioxidant status in birds: complexity in inter- and intraspecific correlations among circulating antioxidant types." Functional Ecology **23**(2): 310-320.

Corsolini, S., M. Nigro, S. Olmastroni, S. Focardi and F. Regoli (2001). "Susceptibility to oxidative stress in Adélie and emperor penguin." Polar Biology **24**(5): 365-368.

Costantini, D. (2008). "Oxidative stress in ecology and evolution: lessons from avian studies." Ecology Letters **11**(11): 1238-1251.

Depledge, M. H. and A. K. Lundebye (1996). "Physiological monitoring of contaminant effects in individual rock crabs, *Hemigrapsus edwardsi*: The ecotoxicological significance of variability in response." Comparative Biochemistry and Physiology Part C: Pharmacology, Toxicology and Endocrinology **113**(2): 277-282.

Fang, Y.-Z., S. Yang and G. Wu (2002). "Free radicals, antioxidants, and nutrition." Nutrition **18**(10): 872-879.

Furness, R. W. and D. M. Bryant (1996). "Effect of Wind on Field Metabolic Rates of Breeding Northern Fulmars." Ecology **77**(4): 1181-1188.

Gabrielsen, G. W. (2007). Levels and effects of persistent organic pollutants in arctic animals. Arctic Alpine Ecosystems and People in a Changing Environment. J. B. Ørbæk, R. Kallenborn, I. Tombre, E. N. Hegseth, S. Falk-Petersen and A. H. Hoel, Springer Berlin Heidelberg. **4**: 377-412.

Gabrielsen, G. W., I. G. Alsos and B. Brekke (1997). Undersøkelser av PCB i jord, fisk og sjøfugl i området rundt avfallsfyllingen på Jan Mayen, Norsk polarinstitutt. **104**: 31 pp.

Gabrielsen, G. W. and M. Ryg (1992). Fugl og pattedyr. Økosystem Barentshavet. A. B. E. Saxhaug, B. Gulliksen, H. Loeng and F. Mehlum, Editors. Trondheim, NINA: pp. 209–229.

Gabrielsen, G., F. Mehlum and H. Karlsen (1988). "Thermoregulation in four species of arctic seabirds." Journal of Comparative Physiology B: Biochemical, Systemic, and Environmental Physiology **157**(6): 703-708.

Gabrielsen, G. W., M. Fridtjof and K. A. Nagy (1987). "Daily Energy Expenditure and Energy Utilization of Free-Ranging Black-Legged Kittiwakes." The Condor **89**(1): 126-132.

Galvani, P., A. Cassani, P. Fumagalli and A. Santagostino (2000). "Effect of Paraquat on Glutathione Activity in Japanese Quail." Bulletin of Environmental Contamination and Toxicology **64**(1): 74-80.

Griffith, O. W. (1980). "Determination of glutathione and glutathione disulfide using glutathione reductase and 2-vinylpyridine." Analytical Biochemistry **106**(1): 207-212.

Halliwell, B. and J. M. C. Gutteridge (1999). Ch 2: The chemistry of free radicals and related "reactive species". Free Radical Biology and Medicine. B. Halliwell, Gutteridge, J.M.C. Oxford, Oxford University Press. **10**: 36-104.

Halliwell, B. and J. M. C. Gutteridge (1999). Ch. 3: Antioxidant defences. Free Radicals in Biology and Medicine. B. Halliwell, Gutteridge, J.M.C. Oxford, Oxford University Press: 105-245.

Halliwell, B. and J. M. C. Gutteridge (1999). "Free radicals in biology and medicine, second edition : 540 pp. 1989." Free Radical Biology and Medicine **10**(6): 449-450.

Hegseth, M., L. Camus, L. Helgason, F. Regoli, R. Bocchetti and G. Gabrielsen (2010). "Hepatic antioxidant responses in three species of Arctic seabird chicks, species differences and relationships to halogenated organic contaminant levels. MS in prep, May 2010."

Helberg, M., J. O. Bustnes, K. E. Erikstad, K. O. Kristiansen and J. U. Skaare (2005). "Relationships between reproductive performance and organochlorine contaminants in great black-backed gulls (*Larus marinus*)." Environmental Pollution **134**(3): 475-483.

Helgason, L. B., A. Arukwe, G. W. Gabrielsen, M. Harju, M. N. Hegseth, E. S. Heimstad, E. H. Jørgensen, A. S. Mortensen and J. Wolkers (2010). "Biotransformation of PCBs in Arctic seabirds: Characterization of phase I and II pathways at transcriptional, translational and activity levels." Comparative Biochemistry and Physiology Part C: Toxicology & Pharmacology **In Press, Corrected Proof**.

Helmut, S. (1993). "Strategies of antioxidant defense." European Journal of Biochemistry **215**(2): 213-219.

Henriksen, E. O., G. W. Gabrielsen, S. Trudeau, J. Wolkers, K. Sagerup and J. U. Skaare (2000). "Organochlorines and Possible Biochemical Effects in Glaucous Gulls (*Larus hyperboreus*) from Bjørnøya, the Barents Sea." Archives of Environmental Contamination and Toxicology **38**(2): 234-243.

Isaksson, C., P. McLaughlin, P. A. T. Monaghan and S. Andersson (2007). "Carotenoid pigmentation does not reflect total non-enzymatic antioxidant activity in plasma of adult and nestling great tits, *Parus major*." Functional Ecology **21**: 1123-1129.

Isaksson, C., J. Sturve, B. C. Almroth and S. Andersson (2009). "The impact of urban environment on oxidative damage (TBARS) and antioxidant systems in lungs and liver of great tits, *Parus major*." Environmental Research **109**(1): 46-50.

Isaksson, C., J. Örnborg, E. Stephensen and S. Andersson (2005). "Plasma Glutathione and Carotenoid Coloration as Potential Biomarkers of Environmental Stress in Great Tits." EcoHealth **2**(2): 138-146.

Kaushik, S. and J. Kaur (2003). "Chronic cold exposure affects the antioxidant defense system in various rat tissues." Clinica Chimica Acta **333**(1): 69-77.

Kehrer, J. P. (1993). "Free Radicals as Mediators of Tissue Injury and Disease." Critical Reviews in Toxicology **23**(1): 21-48.

Lech, J. J. and J. R. Bend (1980). "Relationship between Biotransformation and the Toxicity and Fate of Xenobiotic Chemicals in Fish." Environmental Health Perspectives **34**: 115-131.

Lehtinen, K.-J. (1990). "Mixed-Function Oxygenase Enzyme Responses and Physiological Disorders in Fish Exposed to Kraft Pulp-Mill Effluents: A Hypothetical Model." Ambio **19**(5): 259-265.

Letcher, R., E. Klasson-Wehler and A. Bergman (2000). Methyl Sulfone and Hydroxylated Metabolites of Polychlorinated Biphenyls. Volume 3 Anthropogenic Compounds Part K: 315-359.

Letcher, R. J., J. O. Bustnes, R. Dietz, B. M. Jenssen, E. H. Jørgensen, C. Sonne, J. Verreault, M. M. Vijayan and G. W. Gabrielsen (2010). "Exposure and effects assessment of persistent organohalogen contaminants in arctic wildlife and fish." Science of The Total Environment **In Press, Corrected Proof**.

Lorentsen, S.-H. and I. P. Tatarinkova (2000). Herring gull. The Status of Marine Birds Breeding in the Barents Sea Region. T. Anker-Nilssen, V. Bakken, Y. Strom, A. N. Golovkin, V. V. Bianki and I. P. Tatarinkova. Tromsø, The Norwegian Polar Institute. **1**: 91-93.

Mahmoud, K. Z. and F. W. Edens (2003). "Influence of selenium sources on age-related and mild heat stress-related changes of blood and liver glutathione redox cycle in broiler chickens (*Gallus domesticus*)." Comparative Biochemistry and Physiology Part B: Biochemistry and Molecular Biology **136**(4): 921-934.

Mateo, R. and D. J. Hoffman (2001). "Differences in oxidative stress between young Canada geese and mallards exposed to lead contaminated sediment." Journal of Toxicology and Environmental Health, Part A: Current Issues **64**(7): (531 - 545).

McCord, J. M. (2000). "The evolution of free radicals and oxidative stress." The American Journal of Medicine **108**(8): 652-659.

- Mehlum, F. and F. F. Daelemans (1995). "PCBs in arctic seabirds from the svalbard region." Science of The Total Environment **160-61**: 441-446.
- Mehlum, F. and V. Bakken (1994). Seabirds in Svalbard (Norway): status, recent changes and management. Seabirds on islands: threats, case studies and action plans. D. N. Nettleship, J. Burger and M. Gochfield, Birdlife conservation series. **No. 1**: 155-171.
- Mehlum, F. and G. W. Gabrielsen (1993). "The diet of high-arctic seabirds in coastal and ice-covered, pelagic areas near the Svalbard archipelago." Polar Research **12**(1): 1-20.
- Morales, A. E., A. Pérez-Jiménez, M. Carmen Hidalgo, E. Abellán and G. Cardenete (2004). "Oxidative stress and antioxidant defenses after prolonged starvation in *Dentex dentex* liver." Comparative Biochemistry and Physiology Part C: Toxicology & Pharmacology **139**(1-3): 153-161.
- Munshi-South, J. and G. S. Wilkinson (2010). "Bats and birds: Exceptional longevity despite high metabolic rates." Ageing Research Reviews **9**(1): 12-19.
- Regoli, F., S. Gorbi, G. Frenzilli, M. Nigro, I. Corsi, S. Focardi and G. W. Winston (2002). "Oxidative stress in ecotoxicology: from the analysis of individual antioxidants to a more integrated approach." Marine Environmental Research **54**(3-5): 419-423.
- Regoli, F. (2000). "Total oxyradical scavenging capacity (TOSC) in polluted and translocated mussels: a predictive biomarker of oxidative stress." Aquatic Toxicology **50**(4): 351-361.
- Regoli, F., M. Nigro, S. Bompadre and G. W. Winston (2000). "Susceptibility to oxyradical toxicity in Antarctic, Arctic, and Mediterranean scallops." Marine Environmental Research **50**(1-5): 547-547.
- Regoli, F. and G. W. Winston (1999). "Quantification of Total Oxidant Scavenging Capacity of Antioxidants for Peroxynitrite, Peroxyl Radicals, and Hydroxyl Radicals." Toxicology and Applied Pharmacology **156**(2): 96-105.
- Robinson, M. K., R. R. Rustum, E. A. Chambers, J. D. Rounds, D. W. Wilmore and D. O. Jacobs (1997). "Starvation Enhances Hepatic Free Radical Release Following Endotoxemia." Journal of Surgical Research **69**(2): 325-330.
- Sagerup, K., L. B. Helgason, A. Polder, H. Strøm, T. D. Josefsen, J. U. Skåre and G. W. Gabrielsen (2009). "Persistent organic pollutants and mercury in dead and dying glaucous gulls (*Larus hyperboreus*) at Bjørnøya (Svalbard)." Science of The Total Environment **407**(23): 6009-6016.
- Sandanger, T. M., M. Sinotte, P. Dumas, M. Marchand, C. D. Sandau, D. Pereg, S. Bérubé, J. Brisson and P. Ayotte (2007). "Plasma Concentrations of Selected Organobromine Compounds and Polychlorinated Biphenyls in Postmenopausal Women of Québec, Canada." Environ Health Perspect **115**(10).

- Scott, R. B., K. S. Reddy, K. Husain, E. C. Schlorff, L. P. Rybak and S. M. Somani (2000). "Dose response of ethanol on antioxidant defense system of liver, lung, and kidney in rat." Pathophysiology **7**(1): 25-32.
- Selman, C., J. S. McLaren, M. J. Himanka and J. R. Speakman (2000). "Effect of long-term cold exposure on antioxidant enzyme activities in a small mammal." Free Radical Biology and Medicine **28**(8): 1279-1285.
- Strøm, H. (2006). Common eider, *Somateria mollissima*. Birds and mammals of Svalbard. K. M. Kovacs and C. E. Lydersen. Tromsø, Norsk Polarinstitutt: 104-107.
- Strøm, H. (2006). Krykkje, *Rissa tridactyla*. Birds and mammals of Svalbard. K. M. Kovacs and C. E. Lydersen. Tromsø, Norsk Polarinstitutt: 147-150.
- Strøm, H. (2006). Northern fulmar, *fulmarus glacialis*. Birds and mammals of Svalbard. K. M. Kovacs and C. E. Lydersen. Tromsø, Norsk Polarinstitutt: 91-94.
- Tarpey, M. M., D. A. Wink and M. B. Grisham (2004). "Methods for detection of reactive metabolites of oxygen and nitrogen: in vitro and in vivo considerations." Am J Physiol Regul Integr Comp Physiol **286**(3): R431-444.
- Timofeev, S. F. (2001). "About the Book "The Status of Marine Birds Breeding in the Barents Sea Region" [Eds. T. Anker-Nilssen, V. Bakken, Y. Strom, A.N. Golovkin, V.V. Bianki, I.P. Tatarinkova], Tromsø: The Norwegian Polar Institute, 2000, 213 pp." Russian Journal of Marine Biology **27**(3): 195-195.
- Verreault, J., S. Shahmiri, G. W. Gabrielsen and R. J. Letcher (2007). "Organohalogen and metabolically-derived contaminants and associations with whole body constituents in Norwegian Arctic glaucous gulls." Environment International **33**(6): 823-830.
- Verreault, J., J. U. Skaare, B. M. Jenssen and G. W. Gabrielsen (2004). "Effects of Organochlorine Contaminants on Thyroid Hormone Levels in Arctic Breeding Glaucous Gulls, *Larus hyperboreus*." Environmental Health Perspectives **112**(5): 532-537.
- Winston, G. W. and R. T. Di Giulio (1991). "Prooxidant and antioxidant mechanisms in aquatic organisms." Aquatic Toxicology **19**(2): 137-161.
- Winston, G. W., F. Regoli, A. J. Dugas, J. H. Fong and K. A. Blanchard (1998). "A Rapid Gas Chromatographic Assay for Determining Oxyradical Scavenging Capacity of Antioxidants and Biological Fluids." Free Radical Biology and Medicine **24**(3): 480-493.

Appendix:

Table 4: Values for all parameters in all individuals of the three species common eider (E61-E70), kittiwake (K61-K70) and northern fulmar (F3-F10). The parameters are protein concentration, catalase activity, glutathione reductase (GR) activity, selenium independent glutathione peroxidase (GPX) activity, selenium dependent GPX, total levels of glutathione (GSH) and ratio between (GSH/ GSSG, oxidised glutathione). The values highlighted in red are outliers of the dataset.

Individ	Proteins (mg)	Catalase/ mg protein	GR/mg protein	GPX se ind/ mg protein	GPX se dep /mg protein	µM Tot. GSH/ mg protein	µM GSH/GSSG pr mg protein
E61	38.54	40.33	17.22	37.31	113.45	45.49	7.13
E62	37.08	35.51	20.00	50.01	65.09	78.05	3.87
E63	35.22	50.69	25.98	68.73	82.53	78.32	4.75
E64	44.18	28.13	22.76	37.44	84.50	38.68	7.60
E65	36.04	23.87	28.53	31.97	80.36	81.13	3.39
E66	49.69	25.39	20.50	30.85	57.34	36.99	3.72
E67	49.76	26.46	14.81	35.40	67.20	62.94	5.25
E68	49.18	14.10	11.85	26.59	73.51	33.20	3.44
E69	51.12	19.18	12.76	30.47	68.73	54.77	2.88
E70	48.23	43.38	14.88	40.08	62.08	41.81	3.34
Mean	43.90	30.71	18.93	38.88	75.48	55.14	4.54
SD	6.49	11.47	5.62	12.33	16.09	18.71	1.65
K61	27.91	48.81	23.78	90.06	144.78	76.80	2.87
K62	48.76	24.70	15.21	71.22	46.46	65.38	4.83
K63	45.88	19.91	19.94	36.48	109.34	60.34	5.32
K64	62.22	20.80	16.16	37.21	87.57	48.97	4.64
K65	53.79	23.04	19.11	40.52	82.50	52.44	3.36
K66	49.06	18.20	20.76	33.21	101.66	42.03	4.18
K67	49.05	20.11	15.02	44.58	95.10	59.08	4.11
K68	54.12	16.85	10.77	-	37.79	51.53	4.02
K69	46.00	31.53	14.18	15.69	102.44	67.98	2.97
K70	49.04	15.78	14.64	-	83.89	59.29	2.59
Mean	48.58	23.97	16.96	46.12	89.15	58.38	3.89
SD	8.73	9.82	3.85	23.48	30.56	10.13	0.91
F3	25.01	32.25	28.80	79.37	202.96	111.87	3.86
F4	33.27	23.68	18.18	39.41	123.78	95.45	4.09
F5	25.49	24.77	35.37	71.98	206.27	113.98	7.02
F6	23.38	27.89	41.52	72.74	188.74	384.78	4.29
F7	34.60	8.54	23.21	32.79	140.09	77.37	5.49
F8	41.54	22.34	21.74	22.19	145.13	63.62	9.00
F9	39.14	20.24	20.42	23.00	123.69	60.30	4.88
F10	25.31	21.83	34.49	43.41	169.19	90.83	4.25
Mean	30.96	22.69	27.97	48.11	162.48	124.78	5.36
SD	7.09	6.87	8.42	23.26	34.01	106.93	1.79

Table 5: Mean values and standard deviation (SD) for all the treatment groups of herring gull (*Larus argentatus*) chicks collected at Sommarøy, Northern Norway 2008. The different treatment groups (n=8) were fed herring and fish oil (clean or contaminated) until capable to flight. The values are expressed as TOSC units/ mg protein and ng/g ww PCB.

Group		Σ PCB	ROO	OH	NOO	Protein conc.
Control	Mean	9.39	571.07	745.06	1094.70	179.74
	SD	3.34	125.52	120.13	223.74	23.13
Fasted	Mean	17.98	518.23	598.76	1059.71	180.63
	SD	8.18	80.32	93.13	165.46	12.77
Exposed	Mean	147.38	468.32	545.04	1039.90	186.58
	SD	41.59	82.09	101.98	102.71	13.12
Exposed + Fasted	Mean	746.38	736.82	726.84	1426.93	137.11
	SD	477.11	126.61	181.39	394.16	22.62
Reference	Mean	-	542.37	1179.85	1341.12	164.44
	SD	-	105.90	631.90	178.28	8.33

Table 6: Difference and 95% confidence interval (lower-upper) and adjusted p-value given for each comparison of log transformed sum PCB levels between treatment groups of herring gull (*Larus argentatus*), derived from Tukey's Honestly Significant Difference test, after verifying significant difference between species by ANOVA. Significant values are highlighted.

		Exposed		
		+fasted	Control	Fasted
Control	Difference	4.74		
	95% CI	3.91-5.56		
Fasted	Difference	4.07	0.67	
	95% CI	3.24-4.89	-0.15-1.49	
Exposed	Difference	1.61	3.13	2.46
	95% CI	0.78-2.43	2.30-3.95	1.63-3.28

Table 7: Regression relationship between log transformed PCB level and log transformed TOSC level of two treatment groups of herring gull (*Larus argentatus*) collected at Sommarøy, Troms summer 2008. The different treatment groups were fed herring and fish oil (clean or contaminated) until capable to fly. The values highlighted with asterix are significantly correlated ($p < 0.05$), the slope reveals positive or negative correlation, the adjusted r^2 gives an estimate of how well the data plots fit with the respective slope, whereas the F_{1-14} is the F ratio.

		NOO	HO	ROO
Control vs Exposed	Slope	-0.02	-0.12	-0.06
	adj r2	-0.04	0.52	0.15
	F 1-14	0.48	17.47	3.66
	p-value	0.498	0.001	0.076
Control vs Exposed+F	Slope	0.05	-0.02	0.05
	adj r2	0.11	-0.04	0.22
	F 1-14	2.76	0.48	5.24
	p-value	0.12	0.502	0.038
Fasted vs Exposed	Slope	0.01	-0.07	-0.02
	adj r2	-0.07	0.17	-0.04
	F 1-14	0.04	4.14	0.47
	p-value	0.848	0.0614	0.506
Fasted vs Exposed+F	Slope	0.06	0.03	0.09
	adj r2	0.20	-0.02	0.49
	F 1-14	4.84	0.77	15.32
	p-value	0.045	0.395	0.00016

Table 8: Values for all parameters in all individuals of the four treatment groups of herring gull chicks (*Larus argentatus*) exposed to HOCs. The parameters are protein concentration, sum PCB levels, total oxidant scavenging capacity towards peroxyradicals (ROO), hydroxyl radicals (OH) and peroxyntirite (NOO). The values highlighted in red are outliers of the dataset.

Group	Σ PCB	ROO	OH	NOO	Protein conc.
Control	12.76	556.12	788.71	891.60	180.90
	10.55	802.68	604.40	940.33	154.23
	9.38	687.09	893.33	1494.62	155.42
	10.67	423.47	649.85	787.73	185.04
	9.05	461.48	893.94	1176.09	222.80
	3.65	614.49	827.51	1132.88	187.47
	13.46	501.44	681.08	1087.86	192.33
	5.61	521.83	621.66	1246.50	159.71
Fasted	8.86	471.29	629.73	1018.26	157.66
	7.36	457.23	690.83	984.84	200.42
	28.05	620.69	460.22	1266.33	177.38
	18.46	445.82	632.06	830.79	190.66
	19.05	657.00	487.83	1288.47	177.04
	13.71	457.33	732.23	1068.61	188.14
	30.27	534.45	573.88	1136.47	179.52
	18.06	502.01	583.28	883.89	174.23
Exposed	82.04	371.11	766.84	945.08	176.09
	161.46	379.66	424.92	1232.08	187.76
	161.86	595.75	521.96	1022.90	192.90
	134.51	426.81	480.82	1031.10	170.66
	197.55	501.28	589.02	913.72	213.38
	132.06	501.87	515.15	980.91	189.71
	107.85	552.62	556.23	1125.84	178.57
	201.69	417.49	505.40	1067.57	183.61
Exposed + Fasted	919.52	499.82	982.40	1289.87	150.19
	541.18	638.59	784.75	1513.18	133.04
	1260.74	873.36	706.26	1465.14	171.85
	127.84	824.29	778.97	1258.65	129.90
	536.46	837.64	907.55	1213.41	102.71
	708.22	669.81	627.89	1429.20	113.85
	1552.90	810.54	401.68	948.83	157.38
	324.20	740.47	625.18	2297.18	138.00
Reference	NA	730.01	2455.43	1315.29	161.85
	NA	527.61	905.04	1587.51	172.47
	NA	386.50	733.61	1250.24	161.14
	NA	560.69	679.37	1565.42	178.14
	NA	604.73	844.90	1288.17	163.95
	NA	428.65	999.76	1375.00	162.00
	NA	577.78	967.67	1027.90	165.90
	NA	523.00	1853.03	1319.39	150.04