



**UIT**

THE ARCTIC  
UNIVERSITY  
OF NORWAY

Faculty of science and technology

Department of technology and safety

# **Investigation and analysis of the ‘cold’ sensation relation with respect to associated parameters: wind velocity, ambient temperature, humidity, and irradiance**

**Amir Nadem Leyli**

*Master's thesis in technology and safety in the high north/July 2019*





## Project report – Page 2

University of Tromsø – The Arctic

University of Norway

Department of Technology and Safety



<b>Field of study:</b> Technology and Safety in the High North	<b>Year:</b> 2019
<b>Title:</b> Investigation and analysis of the ‘cold’ sensation relation with respect to associated parameters: wind velocity, ambient temperature, humidity, and irradiance	<b>Date:</b> 14.07.19 <b>Number of pages:</b> 145
<b>Author:</b> Amir Nadem Leyli	
<b>Confidentiality:</b> Classified	
<b>Supervisor:</b> Abbas Barabadi	<b>Co-supervisor:</b> Hassan Abbas Khawaja
<b>Client:</b> WINDTECH AS	<b>Client contact person:</b> Hassan Abbas Khawaja
<b>Abstract:</b> <p>The Arctic is considered as one of the regions in the world with various resources including oil and gas. Many industries are moving further up north to this area or new industries are being established. Technologies and industries in the Arctic have many challenges regarding harsh cold climate. One of the main challenges which is of importance in this thesis is human exposure to the cold that affect operation conditions and can increase HSE risks.</p> <p>WINDTECH team has devised a tool for measuring the sensation of the ‘cold’. The ‘cold’ is measured with an electrical heater. The heater is exposed to the different weather conditions with a fixed power and it will be stabilized within a short period of time which it referred to as ‘heated temperature’. The higher values of ‘heated temperature’ indicate lower heat loss and less values mean higher heat loss. Therefore, to manage the risks for human exposure to cold it is important to measure all the parameters that affect the ‘heated temperature’, including ambient temperature, humidity, wind velocity, and irradiance. WINDTECH team device is equipped with sensors that measure ambient temperature, humidity, irradiance, pressure and ‘heated temperature’. It is challenging to measure wind velocities however, analysis have showed wind velocity can be estimated with decent accuracy using pressure values. In this thesis the WINDTECH device is implemented to perform the experiments both in the lab and in the field in various conditions to collect data, all the parameters have been measured with the device and analyzed separately to investigate their effects on the ‘heated temperature’ and their cumulative effect, to give an estimation of ‘heated temperature’ values which indicates the heat loss amount. The analysis can be implemented to decrease the risks involved with operation conditions.</p> <p>Since the WINDTECH device is under patenting process this report is confidential.</p>	
<b>Keywords:</b> Cold sensation, Heated temperature, Heat loss, wind velocity, pressure, humidity, irradiance	

## **Preface and acknowledgments**

The presented thesis is the final assignment in my master's degree in "Technology and Safety in The High North" at the faculty of science and technology (NT-Fak) – UiT – The Arctic University of Norway, Tromsø.

In autumn 2018 I started working with professor Hassan Abbas Khawaja on a project to test various sensors installed on a board which could be used to measure wind velocity implementing pressure values. Then I decided to work more deeply into this project for my MSc thesis. In January 2019 I started to work with WINDTECH AS to test a newly prototyped device which can give a more realistic measure of 'cold' sensation. Part of the thesis was conducted in pre-projects. The thesis is completed from January to July 2019 and is focused on the investigation and analysis of 'heated temperature' associated parameters: wind velocity, ambient temperature, humidity and irradiance.

I would like to give my most sincere thanks to professor Hassan Abbas Khawaja for all the benevolent dedications and guidings during this work. The dearest regards to professor Abbas Barabadi who he always was a great help during my master's degree. I also want to thank Ståle Antonsen for being so supportive, creative and helpful in prototyping the device and making the equipment needed to carry out the experiments.

Amir Nadem Leyli

Tromsø 14th of July 2019

# Abstract

The Arctic is considered as one of the regions in the world with various resources including oil and gas. Many industries are moving further up north to this area or new industries are being established. Technologies and industries in the Arctic have many challenges regarding harsh cold climate. One of the main challenges which is of importance in this thesis is human exposure to the cold that affect operation conditions and can increase HSE risks.

WINDTECH team has devised a tool for measuring the sensation of the 'cold'. The 'cold' is measured with an electrical heater. The heater is exposed to the different weather conditions with a fixed power and it will be stabilized within a short period of time which it referred to as 'heated temperature'. The higher values of 'heated temperature' indicate lower heat loss and less values mean higher heat loss. Therefore, to manage the risks for human exposure to cold it is important to measure all the parameters that affect the 'heated temperature', including ambient temperature, humidity, wind velocity, and irradiance. WINDTECH team device is equipped with sensors that measure ambient temperature, humidity, irradiance, pressure and 'heated temperature'. It is challenging to measure wind velocities however, analysis have showed wind velocity can be estimated with decent accuracy using pressure values. In this thesis the WINDTECH device is implemented to perform the experiments both in the lab and in the field in various conditions to collect data, all the parameters have been measured with the device and analyzed separately to investigate their effects on the 'heated temperature' and their cumulative effect, to give an estimation of 'heated temperature' values which indicates the heat loss amount. The analysis can be implemented to decrease the risks involved with operation conditions.

Since the WINDTECH device is under patenting process this report is confidential.

## Abbreviations

ALARP	As low as reasonably possible
AM	Additive manufacturing
CHT	Conjugate heat transfer
EM	Electromagnetic spectrum
Ta	Ambient temperature
Th	Heated temperature
WRF	Weather research and forecasting model

# Table of Contents

1	Introduction .....	1
1.1	Background .....	1
1.2	Problem description.....	2
1.3	Aim and objectives .....	2
1.4	Research questions .....	3
1.5	Limitations .....	3
1.6	Structure of the thesis .....	3
2	Literature review.....	5
2.1	Physics.....	5
2.1.1	Conjugate heat transfer.....	5
2.2	Wind chill.....	6
2.3	Human body .....	7
2.3.1	Human reaction to cold .....	8
2.3.2	Human exposure to cold.....	9
2.3.3	Cold-related injuries .....	9
2.3.4	Human error .....	10
2.4	Risk management .....	10
2.5	Arctic environment.....	11
2.5.1	Low temperature.....	12
2.5.2	Darkness .....	13
2.5.3	Icing.....	14
2.5.4	Polar low.....	15
2.5.5	Arctic weather and climate .....	15
2.6	Weather research and forecasting model (WRF) .....	17
2.7	Irradiance.....	17
2.8	3-D printing .....	19
2.8.1	Potential use of 3-D printing in the high north.....	20
2.8.2	3-D printing risk matrix development .....	21
3	Methodology.....	23
3.1	Pre-projects.....	23
3.1.1	Pressure difference, wind velocity and ambient temperature analysis .....	23
3.1.2	Wind velocity and pressure difference relation .....	27
3.1.3	Pressure, wind velocity and ambient temperature relation .....	30
3.2	Device setup, design and prototyping .....	31
3.2.1	Sensors on the device .....	32
3.2.2	Battery life.....	35
3.3	Data collection.....	35
3.3.1	Lab experiments .....	35
3.3.2	Field experiments .....	36
3.3.3	Meteorological data.....	37
3.3.4	Equipment .....	38
3.3.5	Termite .....	41
3.3.6	Ambient temperature.....	42

3.3.7	Velocity .....	43
3.3.8	Pressure .....	43
3.3.9	Humidity.....	43
3.3.10	Irradiance.....	43
4	Results and discussion .....	45
4.1	Data analysis.....	45
4.1.1	MATLAB code.....	45
4.1.2	‘Heated temperature’ .....	46
4.2	The influence of ‘heated temperature’ associated parameters.....	48
4.2.1	Velocity .....	48
4.2.2	Pressure .....	51
4.2.3	Irradiance.....	51
4.2.4	Humidity.....	54
4.2.5	Connection between parameters .....	56
5	Conclusion .....	57
6	Suggestion for further work.....	58
7	References .....	59



## Appendix

Appendix I	Pressure and wind velocity graphs
Appendix II	Meteorological data
Appendix III	Sample of raw data
Appendix IV	Heated temperature behaviour examples
Appendix V	Pressure sensor sensitivity analysis

## List of Tables

Table 1 - Windchill chart (Osczevski & Bluestein, 2005) .....	7
Table 2 - Darkness times in some regions of the Arctic ("The Polar Night – a time of colour,").....	14
Table 3 - Icing class and rate by Overland .....	14
Table 4 - 3-D printing risk analysis.....	21
Table 5 - risk matrix before mitigating barriers .....	22
Table 6 - Risk matrix after mitigating barriers.....	22
Table 7 - Irradiance and voltages values .....	51
Table 8 - Field test parameters for 2.4.19.....	55

## List of Figures

Figure 1 - An example of conjugate heat transfer problem (John et al., 2019).....	6
Figure 2 - Swiss cheese model (Gabbert, 2013).....	10
Figure 3 - Risk management process.....	11
Figure 4 - The Arctic map (www.worldatlas.com) .....	12
Figure 5- Daily air temperature for the Arctic (Weisberger & Writer, 2018) .....	13
Figure 6 - Polar lows formed places ("Polar lows explained," 2014) .....	15
Figure 7 - Average wind speed in Tromsø ("Average Weather in Tromsø,").....	16
Figure 8 - EM spectrum (Crockett, 2017) .....	18
Figure 9 - Irradiance changes with time (Landsberg & Sands, 2011).....	18
Figure 10 - Board setup.....	23
Figure 11 - Side wide direction .....	24
Figure 12 - Top wind direction.....	24
Figure 13 - P, V and ambient temperatures (top wind, ref inside) .....	25
Figure 14 - P, V and ambient temperatures (side wind, ref inside).....	26
Figure 15 - P, V and ambient temperatures (top wind, ref outside) .....	26
Figure 16 - P, V and ambient temperatures (side wind, ref outside).....	27
Figure 17 - P & V relation for -5° (top wind, ref inside).....	28
Figure 18 - P & V relation for -5° (side wind, ref inside) .....	29
Figure 19 - P & V relation for -5° (top wind, ref outside).....	29
Figure 20 - P & V relation for -5° (side wind, ref outside).....	30
Figure 21 - BME280 block diagram (Bosch, 2014).....	32
Figure 22 - Si1145 block diagram (LABS, 2014).....	33
Figure 23 - Si7020 sensor block diagram.....	33
Figure 24 - WINDTECH device .....	34
Figure 25 - WINDTECH device internal parts.....	35
Figure 26 - Cold box .....	36
Figure 27 - Field test in Svalbard .....	37
Figure 28 - Field test in Tromsø.....	37

Figure 29 - Cardboard box and other equipment in the cold box.....	38
Figure 30 - Fans.....	39
Figure 31 - Honeycomb used in carton box air entrance.....	39
Figure 32 - Halogen light .....	40
Figure 33 - Voltage regulator .....	40
Figure 34 - Anemometer and regulator .....	41
Figure 35 - Termite software settings.....	42
Figure 36 - Termite commands and main page .....	42
Figure 37 - Sample of data extracted to Excel .....	45
Figure 38 - Data extraction MATLAB code .....	46
Figure 39 - an example of heated temperature behavior in a field test .....	47
Figure 40 - Example of 'heated temperature' behavior in a lab test.....	48
Figure 41 - Th, Ta and Velocity (0 v) .....	49
Figure 42 - Th, Ta and velocity (6 v) .....	49
Figure 43 - Th, Ta and wind velocity (9 v) .....	50
Figure 44 - Th, Ta and wind velocity (12 v) .....	50
Figure 45 - Th, Ta and Irradiance (V=0).....	52
Figure 46 - Th, Ta and Irradiance (V=1).....	52
Figure 47 - Th, Ta and Irradiance (V=2).....	53
Figure 48 - Th, Ta and Irradiance (V=3).....	53
Figure 49 - Th, Ta and Irradiance (V=4).....	54
Figure 50 - Meteorological data for 2.4.19.....	55
Figure 51 - Humidity and heated temperature graph.....	55

## List of equations

Equation 1 - Wind chill .....	7
Equation 2 - PPR .....	14
Equation 3 – Heated temperature .....	57

# 1 Introduction

In this chapter the background information, problem description, aim and objective of the thesis in addition to the limitations exist will be provided.

## 1.1 Background

Many industries are moving up north for the great potential of the Arctic in resources, however, the Arctic environment has different challenges such as harsh cold climate almost all over the year, remoteness which makes any logistics much more difficult, lack of infrastructure due to its remoteness, storms, icing, polar lows, fog, low temperature, wind and polar nights and days in which there is 2 months with no sun above the horizon and two months with no sunset (Barabadi, Garmabaki, & Zaki, 2016) (Swart, 2017).

The main challenge regarding the Arctic is the cold climate which makes working conditions more challenging and sometimes impossible to operate. The coldness influences the body and brain, therefore, it decreases the performability of workers in cold conditions. According to a research lab, SIRRIS in Belgium and oil and gas companies there is a need for a device which monitors the working conditions in cold environments (Swart, 2017).

In 2016 a student and at the University of Tromsø started working on the device. The device can give a more realistic measure of 'cold' sensation on workers operating in cold conditions. This endeavor led to a device developed by WINDTECH team. The device is made of sensors which measure ambient temperature, relative humidity, irradiance, pressure and, 'heated temperature' which is an indication of heat loss in different conditions.

Prior to this thesis, two master theses has been done by students at the University of Tromsø in collaboration with WINDTECH team. The projects led to prototyping and testing the WINDTECH device in the laboratory. There are different parameters affecting the 'heated temperature' (Th), including wind speed, irradiance, humidity and ambient temperature. The effects of each of these parameters towards 'heated temperature' had been analyzed in a master thesis done in June 2018. The results showed increased wind velocity decreases heated temperature which means greater heat loss. In the case of humidity, the results showed that at higher humidity and higher ambient temperatures the heated temperature is lower. However, at relatively lower ambient temperature the humidity works positively, and the 'heated temperature' was higher. The experiments for irradiance showed that 'heated temperatures' are higher with higher amounts of irradiance as it is expected and we all have experienced feeling warmer when standing in the sun rather than in shadows, in addition, the angle of irradiance shows different 'heated temperatures' that are similar to different sense of cold during a day with same temperature (Kaspersen, 2018). In the previous works done, there were some limitations like no velocity

sensor on the board. In this thesis, new sensors have been added to the device which can measure pressure. One sensor on the device will measure the pressure on the exposed condition and another sensor will measure a reference pressure the difference between these two gives a more precise measure of wind speed on the device.

## **1.2 Problem description**

Places with temperatures lower than 10 degrees Celsius are considered cold (Irzmańska, Wójcik, & Adamus - Włodarczyk, 2018). Exposure to cold exists in certain degrees in every activity being done in cold regions (Mäkinen, 2007). People should live and work in the cold climates thus, they try to adapt to conditions by using proper clothing, taking shelter or changing the workplace, all of these solutions cannot be applied sometimes, and the cold environment conditions can decrease human performability both motorically and cognitively which leads to increased risk (Castellani & Young, 2016; Kaspersen, 2018). In harsh cold climates, another issue is wind, human feel colder in windy conditions rather than conditions with no wind this effect is known as wind chill. In order to ensure the workers' safety, the operation condition of the people exposed to cold should be monitored (Swart, 2017). To monitor the operation conditions parameters such as wind speed, irradiance, humidity should be considered as contributing factors to what human really feels in the cold. In this thesis, the focus will be the analysis of the data gathered using WINDTECH device to decide how ambient temperature, wind velocity, irradiance and humidity affects 'heated temperature'. The more precise data on the wind speed can help knowing the 'heated temperature' in a specific working condition which leads to providing more accurate and appropriate risk management plan for humans working condition in the cold.

## **1.3 Aim and objectives**

There are different factors affecting the 'heated temperature' including wind velocity, irradiance, ambient temperature and humidity. 'Heated temperature' which is a measure of cold can be used for the heat loss amount in the conditions that workers are exposed to. The aim of the thesis is to find out:

1. How ambient temperature, wind velocity, humidity and irradiance each affect 'heated temperature'?
2. How wind velocity can be calculated using pressure values?
3. What is the cumulative effect of all the parameters together on 'heated temperature'?

For finding the relation the WINDTECH device is equipped with sensors that measure pressure, heated temperature, humidity and ambient temperature and irradiance. The device is tested in the cold box and in the field. The sensors are exposed to different ambient temperatures and conditions and the heater was set to the maximum power and sensitivity. To find the relation of each parameter with 'heated

temperature' experiments with various conditions and tools is conducted. The data gathered is analysed using MATLAB and Excel.

## **1.4 Research questions**

The thesis is focused on finding the relation and effect of each parameter individually on 'heated temperature' the thesis will try to answer the following questions:

- How 'heated temperature' is affected by wind velocity, humidity, irradiance and ambient temperature individually?
- What is the cumulative effect of wind velocity, humidity, irradiance and ambient temperature towards 'heated temperature'?

## **1.5 Limitations**

Wind velocity has great importance and effect on 'heated temperature' but there is no sensor that can measure it directly on the device thus a wind blower had been used for the experiments and an anemometer which shows the wind blower speed, therefore, the wind velocity being blown on the sensors has some errors however the wind velocity on the sensors can be measured indirectly with pressure. The limitations can be mentioned are:

- There were some inconsistencies in the cold box ambient temperature thus the temperatures measured by the sensor is used for analysis
- Limited field test was performed in this study
- Field tests should be conducted outside in which can have some challenges
- The device is not water proof so it can fail due to rain or snow
- The device may fail due to different possible reasons like excessive heater active time or short circuit

## **1.6 Structure of the thesis**

Chapter one consists of the introduction, background information, the thesis description, aims and the objectives, the thesis research questions, limitations and the thesis structure.

Chapter two includes the literature review, which provides the theoretical information needed and used in the thesis also the previous works done as a basis for this thesis.

In chapter three the methodology used to carry out the experiments and data collection process is discussed.

Chapter four presents the results of the experiments, data analysis and discussing the graph and plots.

Chapter five includes the conclusion and section six introduces some suggestions for further work.

## **2 Literature review**

In this chapter, the theoretical knowledge needed and used for carrying out the thesis is provided. The subjects in this chapter can help better understanding of the whole concept of human exposure to cold in the harsh cold climate.

### **2.1 Physics**

The physics related to this thesis involves heat transfer and more specifically conjugate heat transfer (CHT) where human body and skin works as a solid and have conduction heat transfer and human blood flow and atmosphere airflow are the fluids which they have convection heat transfer with human body, therefore, conjugate heat transfer that considers both convection and conduction is of interest in analysing the human exposure to cold. Furthermore, wind chill effect is closely related to heat transfer (Brauner & Shacham, 1995; Steadman, 1971) which will be discussed later.

#### **2.1.1 Conjugate heat transfer**

Conjugate heat transfer analysis has more than 50 years of history. CHT analysis method has been developed over the years as the most practical way to study heat transfer. In this method the combined effects of the conduction heat transfer in the solid and convection heat transfer in the fluid are considered together (John, Senthilkumar, & Sadasivan, 2019). The vast research area of this field help scientists to develop their work. Most of the recent technologies involve heat transfer from electronic circuits, space vehicles, nuclear reactors, turbine blade heating or cooling to solar panels (Pelletier, Ignat, & Ilinca, 1995).

Heat flux and heat transfer coefficient of the surfaces having heat transfer with the environment are the most important parameters needed for CHT analysis. To calculate the heat transfer coefficient, the combination of fluid and solid field boundary condition is required. This condition is so complex since the wall and freestream parameters change with time. Thus, to solve this problem, various simplified assumptions as in isothermal wall boundary condition should be implemented which is not realistic in practical cases that lead to inaccuracy of the results. For obtaining the close heat transfer coefficient from numerical analysis and experiments, studying the conjugate heat transfer, which is, the boundary condition at the solid-fluid interface is necessary. Basically, CHT analysis is of importance where heat transfer consists of several differential equations. An example, where heat transfer in the fluid is governed by energy, momentum and three-dimensional continuity equations is a solid surface with heat conduction from inside and a fluid flow on the external surface as presented in figure 1 (John et al., 2019).

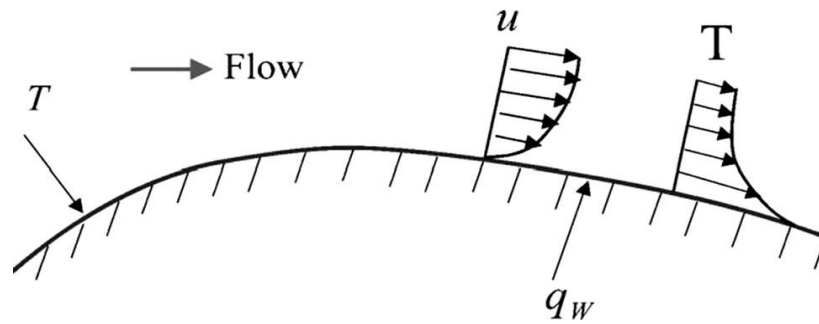

Figure 1 - An example of conjugate heat transfer problem (John et al., 2019)

CHT problems can be solved either by numerical models or analytical methods. Analytical solutions for convection and conduction problems individually are easier, while, CHT problems are much more challenging to solve. Analytical CHT has been presented by many researchers in the past but the numerical methods of CHT analysis became more common in the last decades (Shah & Jain, 2015). Analytical methods require complete knowledge of the problem and many assumptions. The accuracy of results depends on the extent of assumptions validity. Numerical solutions are simpler, each numerical algorithm can be used for several CHT problems. The main equations in CHT problems are:

- The mass conservation law or continuity equation
- Momentum conservation
- Energy conservation law

These equations are governed in steady or unsteady fluid flows. Moreover, for steady and unsteady heat transfer in solid the governing equations are:

- Two dimensional or three-dimensional unsteady energy equation
- Laplace or Poisson equation
- One dimensional steady or unsteady conduction equation

Equation and strategy selection in the solid domain is based on the nature of heat conduction as an example choosing one-dimensional heat equation helps to have a simple analytical solution in the solid-fluid interface. For conjugating the solid and fluid domain there are mainly two different methods. The first method is the approach when all equations in the fluid and solid domain are solved together. The second method is the iterative approach where the solid and fluid domain is solved separately and only the solutions are combined at the interface (John et al., 2019).

## 2.2 Wind chill

The wind chill temperature is an air temperature that in a condition of no wind speed will have the same result in wind chill index when there is wind speed present (Osczevski & Bluestein, 2005). It can also be defined as human discomfort and exposure to danger (Keimig & Bradley, 2002).



Wind chill factor can be explained as a sensation to cold due to the wind in any environment. High wind chill factors can bring health hazard for human operating the cold (Ahmad, Rashid, Khawaja, & Moatamedi, 2016). The wind chill factor considers the combined effect of air temperature and wind speed on humans. It can be used for potentially dangerous conditions humans are exposed to (Bluestein, 1998). Table 3 shows the wind chill chart that illustrates the temperature humans feel when exposed to wind speed using the formula below:

$$WCT (C^\circ) = 13.12 + 0.6215T - 2.37V^{0.16} + 0.3965TV^{0.16} \tag{1}$$

Where T is in Celsius degrees and V is the wind velocity in kilometers per hour.

		Air Temperature (°C)												
		10	5	0	-5	-10	-15	-20	-25	-30	-35	-40	-45	-50
Wind Speed (km h <sup>-1</sup> )	Calm	9	3	-3	9	-15	-21	-27	-33	-39	-45	-51	-57	-63
	10	8	2	-4	-11	-17	-23	-29	-35	-41	-48	-54	-60	-66
	15	7	1	-5	-12	-18	-24	-31	-37	-43	-49	-56	-62	-68
	20	7	1	-6	-12	-19	-25	-32	-38	-45	-51	-57	-64	-70
	25	7	0	-7	-13	-19	-26	-33	-39	-46	-52	-59	-65	-72
	30	6	0	-7	-14	-20	-27	-33	-40	-47	-53	-60	-66	-73
	35	6	-1	-7	-14	-21	-27	-34	-41	-48	-54	-61	-68	-74
	40	6	-1	-8	-15	-21	-28	-35	-42	-48	-55	-62	-69	-75
	45	6	-1	-8	-15	-22	-29	-35	-42	-49	-56	-63	-70	-76
	50	5	-2	-9	-15	-22	-29	-36	-43	-50	-57	-63	-70	-77
	55	5	-2	-9	-16	-23	-30	-37	-43	-50	-57	-64	-71	-78
	60	5	-2	-9	-16	-23	-30	-37	-44	-51	-59	-66	-73	-80
	70	4	-3	-10	-17	-24	-31	-38	-45	-52	-60	-67	-74	-81
80														

Table 1 - Windchill chart (Osczevski & Bluestein, 2005)

NORSOK S-002 standard proposes restrictions for outdoor work. It says for wind chill index of 1000 W/m<sup>2</sup> only 10 minutes of work is allowed and working should be stopped for wind chill index of more than 1600 W/m<sup>2</sup> (Kaspersen, 2018).

### 2.3 Human body

The human body is transmitting energy all the time like any other system. It transmits the energy received from food to work and heat. The 1<sup>st</sup> law of thermodynamics states that the energy always conserves and it only transmits from one form to another (Lucas, 2015). The human metabolism or energy consumption has a direct relation with cells activities. The energy intake from food will be transmitted to work or heat and the rest will be stored as fat (Swart, 2017). The humans are endothermic in which they have the constant core temperature of 37 degrees Celsius, however, there is 1.5 degrees difference between males and females.

### 2.3.1 Human reaction to cold

When humans are exposed to cold the body tries to conserve the heat in the core by reducing the blood flow in the other parts of the body starting with the outermost layer which is the skin. Human performance and reaction to cold is influenced by various factors including temperature, wind, humidity, age, gender, body morphology, the surface to volume ratio, activity level, physical fitness, cold adaptation, clothing, and food intake (Leon, Sandal, & Larsen, 2011). These physical and environmental factors contribute to the cooling of the body core (Auerbach, 2007; Castellani et al., 2006; Heckert, 2011; Medicine, 1996; Rintamäki, 2006; Swart, 2017; Van Ooijen, Van Marken Lichtenbelt, Van Steenhoven, & Westerterp, 2004)

**Ambient temperature:** the surrounding temperature influences the heat production and human metabolism.

**Humidity:** humid air conduction is better than dry air, therefore higher humidity increases heat loss, breathing becomes more difficult in cold air with low humidity

**Wind:** the air blowing on the surface of the skin removes the layer of heat and leads to a colder sensation

**Age:** human older than 60 years of age have less tolerance to low temperatures due to less vasoconstriction. Physical fitness is decreased. Elders feel tired sooner and less sharpen sensitivity to cold which leads to a higher risk of hypothermia.

**Gender:** woman have a lower surface to volume ratio thus the heat loss is bigger. In addition, the menstrual cycle has negative effects on thermoregulatory responses.

**Body:** body size and fat influences heat loss. Fat works as a layer of insulation which works positively when being exposed to cold.

**Surface to volume ratio:** the heat loss is faster in smaller size bodies this is also correct for smaller body parts such as fingers and feet.

**Activity level:** doing physical activities can help maintaining the core temperature

**Good physical fitness:** decent physical fitness leads to higher metabolism and helps the body keep the core temperature in the normal level

**Clothing:** clothing should be implemented wisely; tight clothes can decrease blood flow and loose clothes can lead to bulkiness and decrease performance efficiency. Normal clothing consists of an inner layer, middle layer and outer layer, trapping the air between the layers or in the layer can decrease heat loss.

**Food intake:** the energy consumption usually increases due to extra weight of clothing and increased metabolism to keep the core temperature also dehydration can happen because of unrealistic feeling of full bladder.

### 2.3.2 Human exposure to cold

Humans are endotherm on which we implement the energy received from food to produce heat, doing the daily work and functioning. The heat production should maintain the core temperature of 37 degrees of Celsius. With higher wind speed the body cooling will be faster (Wu et al., 2016). When we are exposed to cold more energy will be used for heat production. Humans respond differently to cold physiologically based on anthropometry, age, sex, race, thermoregulatory fatigue, fitness (Castellani & Young, 2016; Swart, 2017). These factors considered for every individual. There is a certain working condition that one can tolerate although using different equipment and facilities such as proper clothing and protection from cold or wall protecting working areas from wind, snow, etc. At some conditions protections can improve the efficiency of workers however, In many cases the protection cannot help or maybe so expensive or even impossible to implement thus, in these scenarios the only possible solution will be work stoppage. Other than that it may lead to different degrees of injury for human operating in cold and risk increase.

### 2.3.3 Cold-related injuries

There are some certain types of injuries which occur when humans being exposed to cold they are explained briefly below (Castellani et al., 2006; Swart, 2017):

**Frostnip:** frostnip is the freezing in the skin and outer layer tissues which happens in fingers, toes, nose, cheeks and ears. The signs appear with stings and whitening of the skin. Frostnip can be prevented by clothing.

**Frostbite:** frostbite usually influences toes, nose, cheeks, fingers and ears. It is the freezing of tissues in the skin and deeper level. The first-degree frostbite happens when the skin changes color but there would not be any peeling. The second-degree frostbite leads to bruises and peeling of the skin and the third degree kills the skin tissues and maybe deeper level tissues, pain increases, and numbness happen.

**Chill blains:** chill blain cause inflammation. Hand and feet swell and there would be low pains. These signs may remain for some days after stoppage of cold exposure.

**Trench foot:** being exposed to cold, damp and water causes trench foot it can develop to inflammation, redness, itches, numbness and some severe cases tissue death.

**Fingertip fissures:** when being exposed to cold for a long time deep and painful fissuring may happen in the fingertips.

**Cold burn:** superficial freezing of the skin and tissues when touching a super cold surface is called cold burn.

**Hypothermia:** hypothermia is the body's core chilling the normal temperature e.g. 35 degrees Celsius. It can happen be mild from 33 to 35 degrees, moderate (29-32) or severe (9-28).

### 2.3.4 Human error

The terms human factor and human error are used interchangeably as the root cause of accidents happened, referred to people instead of technological failures. However, human factors can be considered as underlying causes of accidents and human error can be defined as immediate causes. Human factors can be categorized to (1) individual factors such as competence, stress and motivation, (2) group factors including management, supervision and crews, and (3) organisational factors like company policies, standards, systems and procedures. Human errors can be divided to three different groups which are (1) skill-based that consists of action and checking errors, (2) rule-based like retrieval and transmission errors and (3) knowledge-based including diagnostic and decision errors (Gordon, 1998). Near 80% of the accidents happen due to human error (Swart, 2017). To decrease the losses human errors should be reduced to the greatest extent. In order to decrease the human errors some barriers can be implemented that leads to reduced risk. Swiss cheese model which can be used to decrease the losses implementing blocks in each level to mitigate the consequences or probabilities of hazards is illustrated in figure 2.

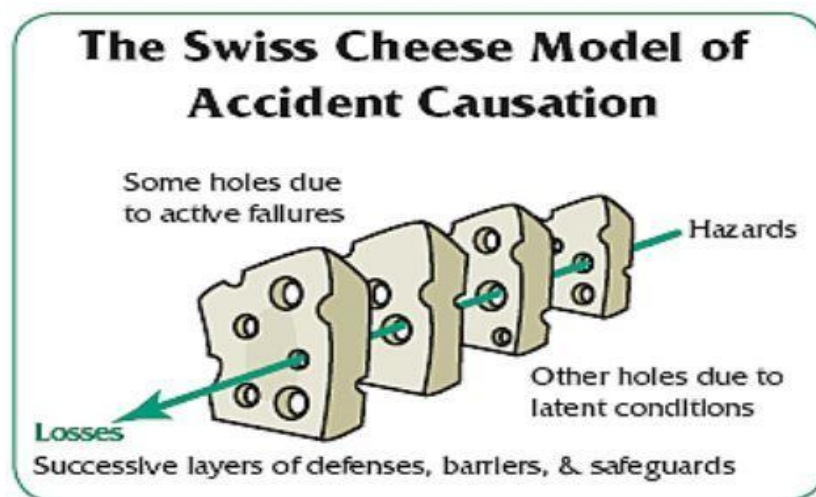

Figure 2 - Swiss cheese model (Gabbert, 2013)

## 2.4 Risk management

Risk can be defined as the effect of uncertainties on objectives. An effect is a difference from expectation which can be positive or negative. Risk is usually expressed as the probability of a failure and its consequences. Risk management can be referred to as all the actions taken to control an organization

considering risk (Luko, 2013). A risk management method for organizations developed based on ISO 31000 standard is presented in figure 3.

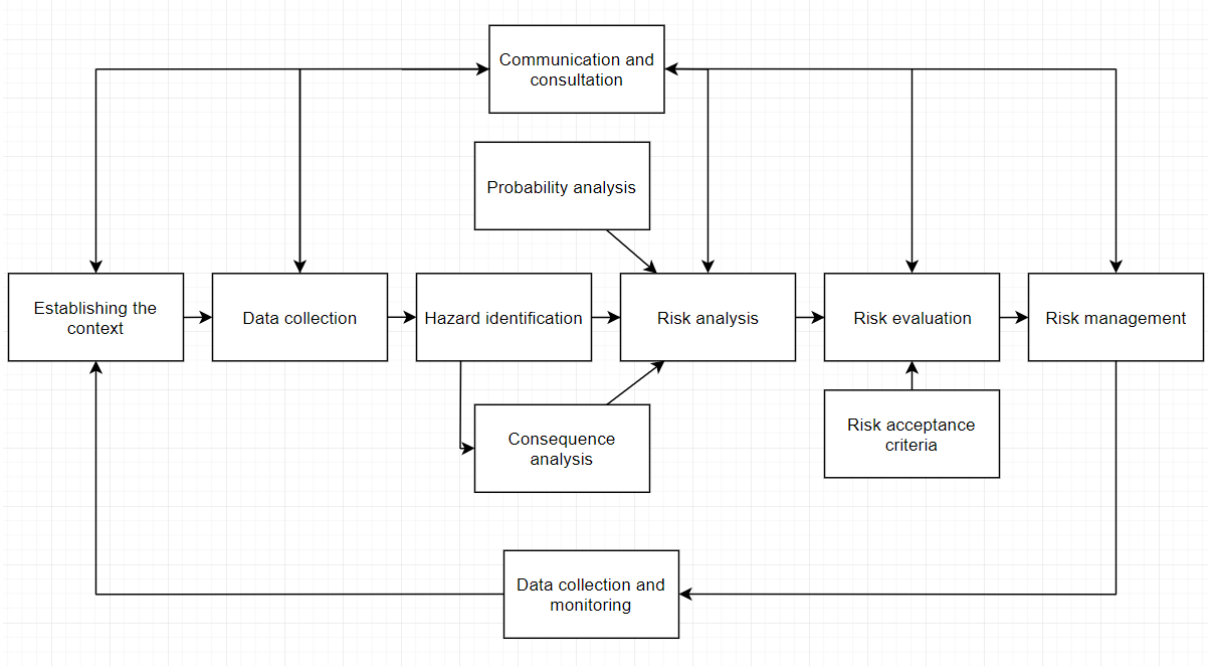

Figure 3 - Risk management process

Any organization, system or technology is influenced by uncertainties which makes it unsure if they can achieve their goal or not that is referred to as “risk”. To decrease the losses and increase the efficiency having a decent risk management system is of importance. The first stage in risk management process is to establish the context by defining the effective parameters and setting the risk criteria. The next stage is data and information collection about any types of hazards and unwanted events this also helps identifying risks more accurately and prioritize on the most important hazards. Risk analysis comes in the next stage where the probability and consequences of events should be considered. Evaluation of the risks should be performed to assess how important each hazard is and how they should be treated. Implementing risk acceptance criteria, it can be decided how the risks should be controlled. All these processes will lead to risk management. Different groups which they work on each part should communicate and consult about their decision on each level. After introducing the risk management data collection and monitoring may suggest that there should be some modification or there would be some unforeseen events which have been neglected and they shall also be considered in all the stages to have a new risk management system.

**2.5 Arctic environment**

The Arctic is the region of the planet above the imaginary line located at 66°, 30'N latitude referred to as the Arctic circle which includes: Arctic Ocean, Greenland, Baffin Island, some other smaller islands, Alaska, Finland, Iceland, Northern Canada, Norway and Sweden.

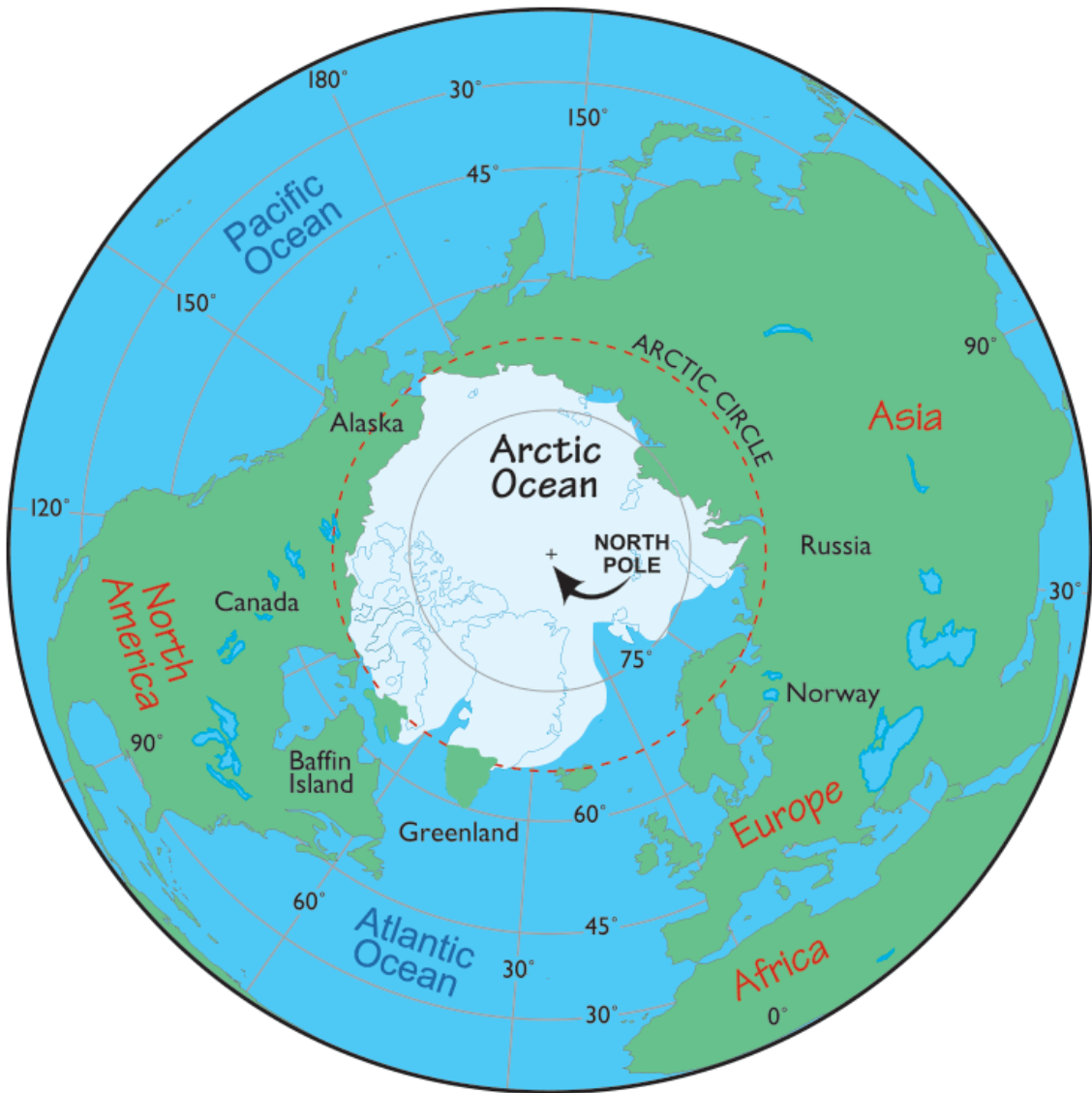

Figure 4 - The Arctic map ([www.worldatlas.com](http://www.worldatlas.com))

The environments in which humans cannot be comfortable in and they need to adapt themselves with atmosphere can be presumed as extreme environments, therefore, the Arctic and polar regions are considered as extreme harsh environments (Pibernat, Ellis-Evans, & Hinghofer-Szalkay, 2007).

These regions have different challenges for operation conditions such as low temperature, icing, darkness, wind etc.

### 2.5.1 Low temperature

Usually during winter when there is no sun above the horizon in the Arctic the average temperature is around minus 20 degrees Celsius. The air temperature pattern 2 meters above the surface in the Arctic is shown in the figure 5. Blue, purple and yellow lines are respectively related to years 1958-2016 and the red line is for the year 2018 (Weisberger & Writer, 2018).

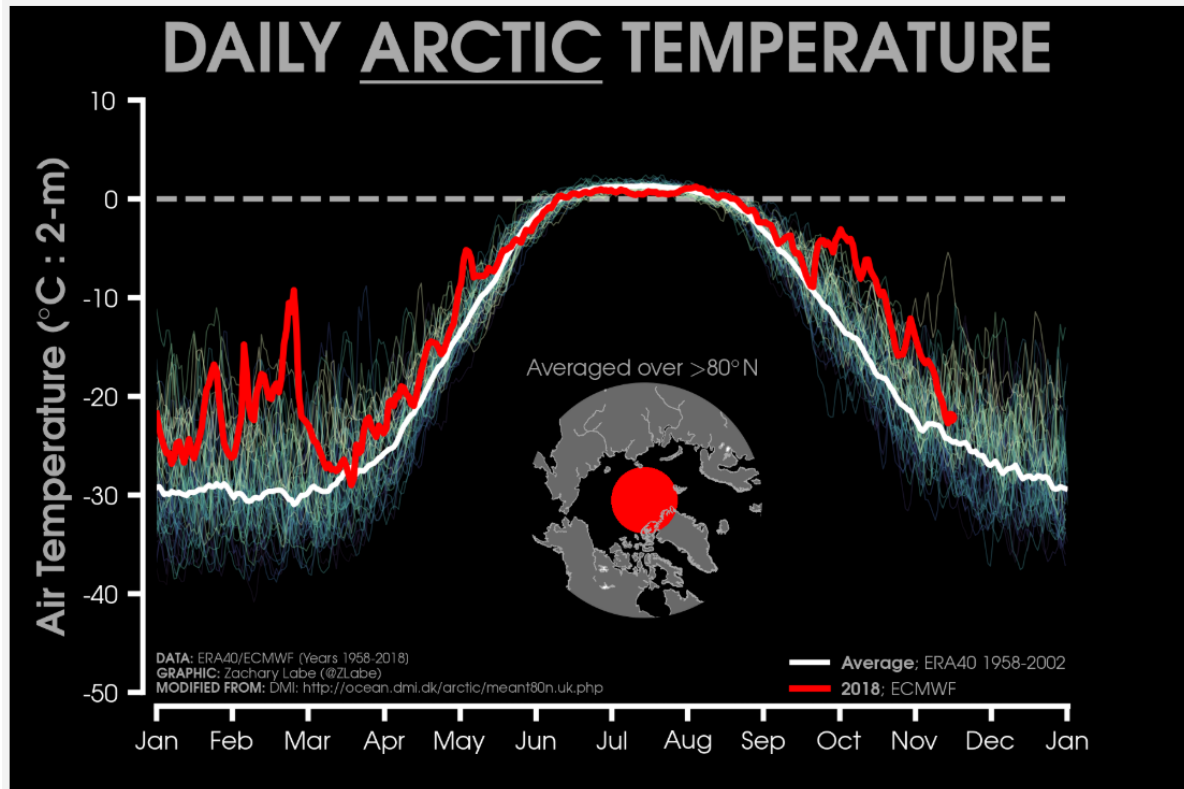

Figure 5- Daily air temperature for the Arctic (Weisberger & Writer, 2018)

The low temperature in the Arctic cause challenges for marine industries and ships, offshore oil and gas platforms, melting of ice due to general global warming but still as long as the temperatures are low for human operating in these regions it has negative effects on the efficiency of workers. The extremely low temperature in polar and sub-polar regions causes ice formation, in these areas all precipitation is in the form of freezing rain, snow or ice pellets. Ice buildup happens in temperatures below 2 degrees of Celsius and wind speeds over 10 m/s (ABS). Some of these challenges can be addressed with equipping the human with proper gloves and clothing however in some situations the working should be stopped due to high levels of risk.

## 2.5.2 Darkness

One of the problems which make some challenges for working conditions in high latitudes is darkness. In these regions in certain times of the year sun sets much sooner than other parts of the world and even does not rise above the horizon from almost end of November to the middle of January, this is exactly all the way around in the summer when sun does not set at all and there is no darkness which is referred to as polar day phenomenon. The higher the latitude the polar night and day becomes more extreme in terms of hours of darkness and daytime. For example, table 2 shows the darkness and daytime of some locations in the Barents Sea which is a part of the Arctic ("The Polar Night – a time of colour,").

Region	Hammerfest	Nordkapp	Vardø	John Castberg	Bjørnøya	Longyearbyen	North pole
No sun above horizon	22 November	20 November	23 November	14 November	7 November	26 October	25 September
Sun return	20 January	22 January	19 January	28 January	4 February	16 February	18 March

Table 2 - Darkness times in some regions of the Arctic ("The Polar Night – a time of colour,")

### 2.5.3 Icing

Icing is a function of wind speed, air temperature, cloud liquid water content, cloud droplet spectra etc.

Icing can generally divide into two categories: 1) Sea spray icing and 2) Atmospheric icing.

Sea spray icing happens so fast when there is high wind speed, low sea temperature, low air temperature. The amount of salt in the sea water that affects the density has an impact on the sea spray icing in addition to sea waves and spray flux volume influence the rate of sea spray icing. This type of icing is the main icing type that occurs in the Arctic. When the air temperature is less than the freezing temperature of sea water in addition to wind speed over 11 m/s the freezing spray will happen. Regarding this, many parts of the Arctic will have the problem of sea spray icing (Jones & Andreas, 2012). Overland has developed a formula for estimating the sea spray icing (Overland, 1990):

$$PPR = \frac{V_a(T_f - T_a)}{1 + 0.3(T_w - T_w)} \quad (2)$$

PPR = Icing Predictor (m C°/s)

$V_a$  = Wind Speed (m/s)

$T_f$  = Freezing point of seawater (-1.7 C° for North Pacific)

$T_a$  = Air Temperature (C°)

$T_w$  = Sea Temperature (C°)

PPR	<0	0-22.4	22.4-53.3	53.3-83	>83.0
Icing Class	None	Light	Moderate	Heavy	Extreme
Icing Rates (Cm/hour)	0	<0.7	0.7-2.0	2.0-4.0	>4.0
(Inches/hour)		<0.3	0.3-0.8.	0.8-1.6	>1.6

Table 3 - Icing class and rate by Overland

Atmospheric icing happens due to a combination of in-cloud water and precipitation in low air temperatures with lead to snow accumulation, glaze, sleet and frost. Sea spray icing will lead to more



ice accretion than atmospheric icing and it occurs when the air temperature is between 0 and 20 degrees Celsius in combination with wind velocities less than 10 m/s (Ryerson, 2009, 2011).

## 2.5.4 Polar low

Polar lows are the small and strong low-pressure system which happens in the Arctic waters. Polar lows happen when the cold air from lands flows over the warmer sea. This flow takes warmth and humidity from the water and makes weather features of thunderstorms. Polar low happens in the whole Norwegian and Barents Sea from October to May. It has a diameter of 200-600 kilometers. Polar low can change weather conditions from calm to strong storms in a very short time and people should stay alert ("Polar lows explained," 2014).

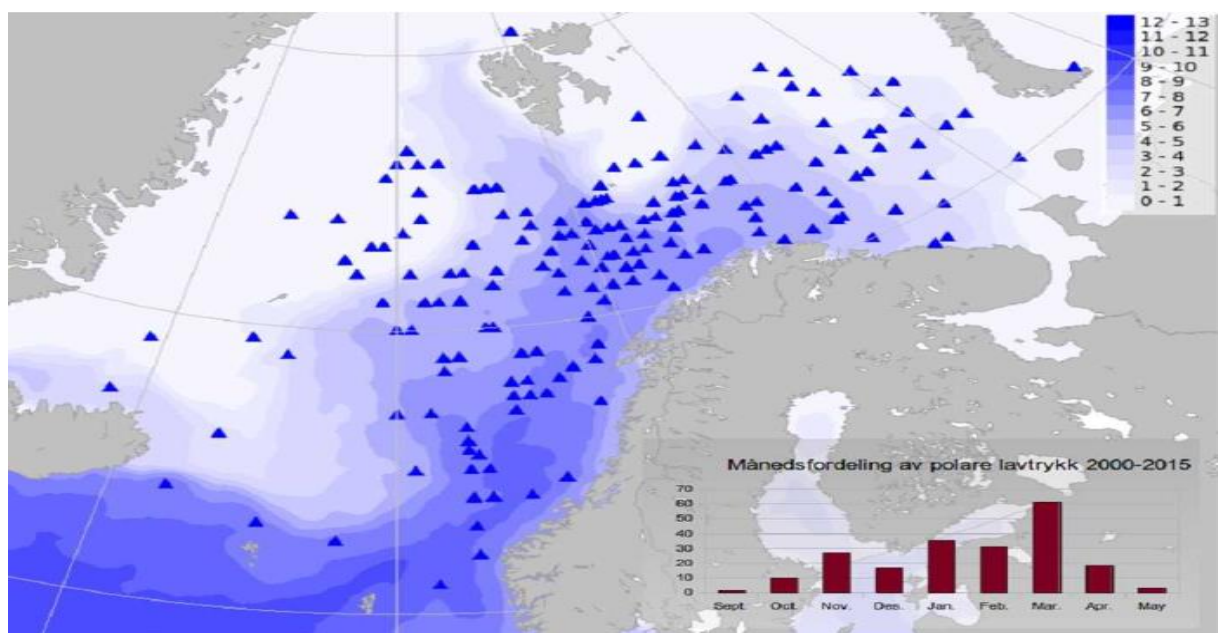

Figure 6 - Polar lows formed places ("Polar lows explained," 2014)

## 2.5.5 Arctic weather and climate

Like any other place, the Arctic weather is influenced by various factors. The weather is affected by latitude, pressure, temperature, geography, wind, humidity, clouds and precipitation ("Factors Affecting Arctic Weather and Climate,"). Each of these factors influences the Arctic weather to a certain extent.

### 2.5.5.1 Pressure

Meteorologists say how weather changes by considering the changes in air pressure. Air pressure or atmospheric pressure is the weight of the column of air above a point. At high latitudes of earth, the pressure is lower due to less air compared to sea level. Changes in air pressure can be an indication of weather forecasting. A pressure decrease causes low-pressure system that leads to cloudy and rainy weather and high pressure causes dry and clear. Researchers study the changes in different types of

pressure patterns to see how they affect temperature, precipitation and winds ("Factors Affecting Arctic Weather and Climate,").

### 2.5.5.2 Wind

The root cause of wind formation is solar radiation. Sun energy transfer heat to the surface of the earth and it is absorbed variously depending on each surface thus the air temperature and pressure changes in different surfaces causing air to move and form winds. The bigger the pressure changes are, the wind will be faster. The wind is a result of all acting forces on the atmosphere including pressure gradient force, gravity, Coriolis force, friction, centrifugal force. Wind speed can be measured by anemometers, pitot tube, drag cylinder, heat dissipation, speed of sound, and cups and propellers (Kirmayer, 2017).

Arctic winds are typically light meanwhile strong gales which reach hurricane power can occur and stay for days. In winter strong winds move the snow towards sheltered areas. Strong winds cause higher wind chill factor which is an indication of body heat loss. Figure 7 shows the average wind speed in Tromsø which is a city above the Arctic circle.

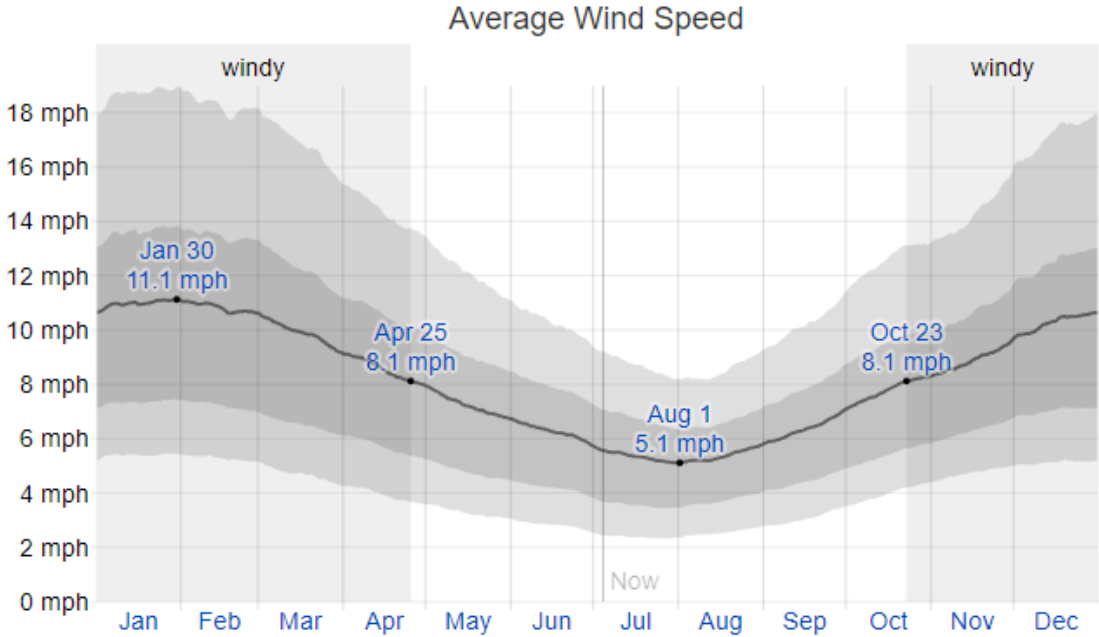

Figure 7 - Average wind speed in Tromsø ("Average Weather in Tromsø,")

### 2.5.5.3 Humidity

Humidity is the water content in the air. Humidity is essential for living. Too dry air can bring health risk for kids or elders. Humidity is usually expressed in two terms relative and absolute humidity. The Relative humidity is absolute humidity in current condition divided by the highest possible absolute humidity in the same condition. Absolute humidity depends on the air temperature. When the relative humidity is 100% it means the air cannot contain more vapor. Humans are sensitive to humidity changes.

Our bodies feel colder in low humidity due to faster sweat evaporation also high humidity can make an uncomfortable situation and quicken the sweating (Chandler).

## **2.6 Weather research and forecasting model (WRF)**

The weather research and forecasting model is the most common numerical weather prediction model from its release in 2000. It is designed both for operational needs and research and it can provide various capabilities for a wide range of applications such as: air chemistry, hydrology, wildland fires, hurricanes and regional climate. WRF is widely accepted since it is free and there are no restrictions on modification and copyright. WRF has two processes first it configures models type, take the inputs and establishes the initial condition, secondly it runs the prediction model. The prediction model operates through WRF's software that analyses input and output data. WRF is usually written in Fortran and also can be written with different compilers and runs on UNIX-like operating systems such as laptops or supercomputers according to data. Simulations in WRF starts with the pre-processing system, it first takes the geographical information to establish user's model then it processes and interpolates the needed atmospheric data and lastly the input data are put on the model and boundary conditions are generated then WRF can run. WRF can also be used for specific predictions including: large-eddy currents, tropical cyclones, supercell convection etc. In addition, individuals can make their own configurations according to their needs (Powers et al., 2017). For example, WRF applications in wind energy use large-eddy currents to forecast wind velocity in wind turbine heights also polar WRF can provide predictions in high latitudes and ice sheets using the latest Arctic system reanalysis dataset from polar WRF (Powers et al., 2017).

## **2.7 Irradiance**

Electromagnetic (EM) radiation is a flow of waves having energy and moving at the speed of light. The electromagnetic spectrum can be expressed regarding wavelength or frequency. EM spectrum consists of all EM radiation. EM spectrum includes radio waves, microwaves, infrared, visible light, ultraviolet, X-ray and gamma ray. Waves with the shorter wave length have higher energy and vice versa ("The Electromagnetic Spectrum," 2013).

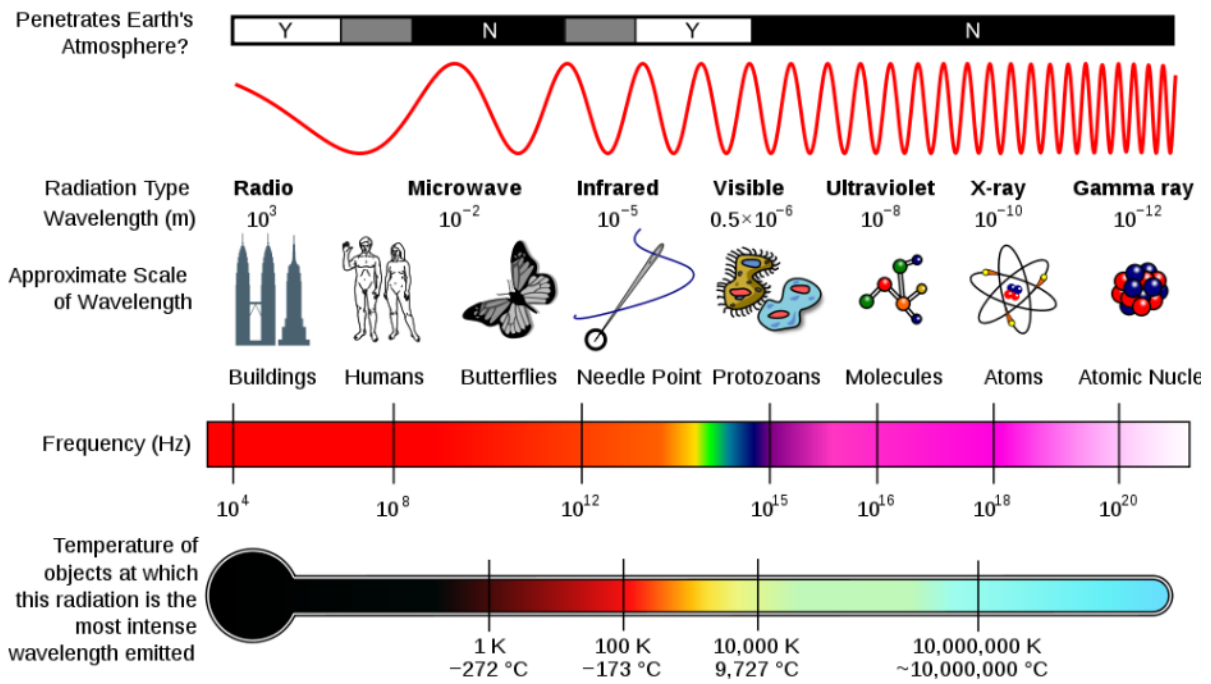

Figure 8 - EM spectrum (Crockett, 2017)

The rate which solar energy is received by a surface is irradiance or flux density. In the SI system irradiance unit is  $W/m^2$  that is Watt per square meter. Irradiance depends on the angle of beam direction. Irradiance changes with the time of the day figure 9 show how irradiance varies in different times of the days in  $42.9^\circ S$  (Landsberg & Sands, 2011).

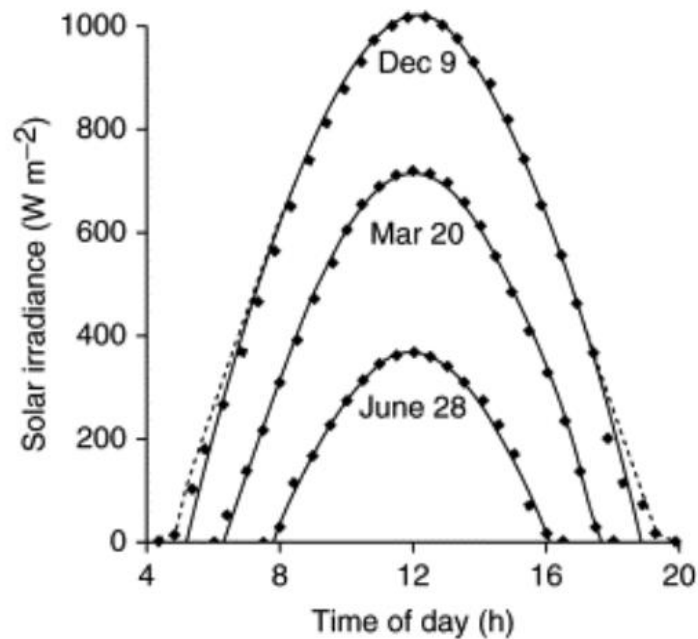

Figure 9 - Irradiance changes with time (Landsberg & Sands, 2011)

The energy being received by humans working in the cold climate changes with time. Since the angle of sun varies with time, during midnight sun period the sun angle and the time the solar energy can be received increases which have a positive effect on cold exposure, on the other hand during darkness in high latitudes there is almost no direct sun light above the horizon, so the irradiance decreases considerably.

## 2.8 3-D printing

About Twenty-five years ago world wide web changed the world, now another technology is gaining popularity that may do this another time 3D printing or additive manufacturing (AM) is a process of making three dimensional solid objects from a 3D model. In the creation of 3D printed objects layers of materials add to each other and form the whole object. AM processes can be categorized to seven different methods which are: VAT photopolymerization-material jetting-material extrusion-powered fusion-binder jetting-direct energy deposition and sheet lamination (Yakout, Elbestawi, & Veldhuis, 2018).

3D printing is opposed to subtractive manufacturing like milling process in which the object is formed by hollowing out or cutting out the material, this small difference makes the whole change. Some of the advantages are listed below (Campbell, Williams, Ivanova, & Garret, 2011).

- Assembly lines and supply chains can be reduced for many products
- The product designs can simply be sent anywhere in the world as a digital file
- Products can be made on demand without inventories and spare parts need
- Manufacturers can be able to produce ranges of products without retooling and additive cost
- Production and distribution of materials could begin to be de-globalized as production can happen close to the consumer
- Manufacturing can be moved away from the manufacturing platform
- The global resource productivity can greatly enhanced, and the use of fossil fuels can be reduced
- Reduced need for labor in manufacturing
- Parts can be more complex
- Reduced inaccuracies due to computer design
- Instant production on a global scale
- Waste reduction

3D printing enables manufacturers to produce complex shapes using less material than traditional manufacturing. 3D printing starts with making a 3D model in a computer software, this digital design is usually a CAD (computer-aided design) file. 3D scanner or 3D printers range from expensive ones which have industrial use to cheap ones anyone can afford and have at home. 3D modeling software

come in different ranges also, from thousand per license a year to some free ones. Software usually are made to work for different fields of technology thus, nowadays, it is possible to find 3D printing software for aerospace, transportation, furniture fabrics, etc.

Different range of materials is now available for 3D-printing such as Plastics, resins, and metals with this range of materials many objects can be made and used in different technologies. Knowing the properties and features of every material that can be used in 3D-printing can help the users have better choices according to what they desire.

### **2.8.1 Potential use of 3-D printing in the high north**

Northern Norway region is full of natural resources, offshore the coast of Finnmark, Nordland and Troms and in Nordic part of Barents Sea oil and natural gas can be found. In addition, these regions are dense resources of flora and fauna, mushrooms and special kinds of berries. Furthermore, the fishing industry is pretty much strong, cod, haddock, polar cod, salmon, perch, capelin and herring are the popular types of fish in this county. Finnmark county of Norway is the main iron ores mines, high-quality slate, and nepheline syenite. Hydropower is the other large resource in northern Norway in Troms, Nordland and Finnmark counties almost all needed electricity is produced with hydropower (Valkonen & Lausala, 1999).

Northern Norway countries have colder climate in comparison to rest of the country, it snows more and accumulates a lot which can lead to roads being closed, electricity loss, transportation challenges or even sometimes airplanes cannot fly due to bad weather conditions. These regions are also remote due to their geographical situation and being captivated by sea and many mountains. For instance, Norway railway only exist to Fauske. This shows that it was not possible or cost efficient to make more railways higher up north although still, ships can transport the equipment or machines used in any technology, but it has its own limits. In these cases, 3D printing can be a great help. With 3D printing the objects can just be printed on the place and on demand with no need for transportation however, It may not be efficient right now for every industry to invest much in 3D printing but for big industries like offshore gas and oil platforms or any other technology which will lose a lot in case of stoppage in production having proper 3D printers for producing the spare parts needed in case of no spare parts to make the system work continuously is essential.

3D printing, in oil and gas technology can be used for manufacturing the equipment needed for extraction, refining, supplying or distribution, since there is much potential for offshore technologies in the high north regions with implementing 3D printers the downtime can be reduced significantly in case of failure, or the need for spare parts can be decreased due to availability of production on demand by 3D printers. In addition, the transportation is always challenging and expensive for offshore technologies which can be reduced using 3D printers.

Also, in other industries like fishing, hydropower plants and mining the same situation quietly exists, they all have the challenges regarding harsh cold climate and remoteness, although 3D printing has limitations but in many situations in can be a proper mean of production with great potential for manufacturing or making any object, technologies can also move towards additive manufacturing by changing their design and materials and make their products and parts printable. By implementing the 3D printing industries can enhance sustainability, survivability, maintainability thus, performability of systems will improve.

## 2.8.2 3-D printing risk matrix development

Like other kinds of technology, there are some risks involved in 3D printing process, in this section some of the hazards in 3D printing will be presented and some solutions regarding those hazards will be brought out, finally, a risk matrix will be developed.

Risks and hazards involved in 3D printing process in cold remote regions and barriers regarding hazards also the probability and consequence of each hazards is presented qualitatively using 5\*5 risk matrix.

HAZARDS	PROBABLITY	CONSEQUENCES	MITIGATING MEASURES	UPDATED PROBABLITY	UPDATED CONSEQUENCE
Reduced functionality due to low temperature (H1)	Frequently	Marginal	Covering 3D printer	Unlikely	Negligible
Fumes or ultrafine particles release (H2)	Likely	Marginal	Using filters and ventilation	unlikely	Negligible
Chemicals contact (H3)	Likely	Marginal	Enclosed system and personnel wearing proper clothing	Unlikely	Minor
Fire (H4)	Quite unlikely	Catastrophic	Regular maintenance	Very unlikely	Catastrophic
Electric shock (H5)	Likely	Catastrophic	Restricted access Maintenance	Unlikely	Critical
Entanglement (H6)	Likely	Critical	Enclosed system around moving parts Skilled staff	Unlikely	Marginal

Table 4 - 3-D printing risk analysis

The risk matrix before mitigating the barriers is presented in table 5. The green area is the acceptable risk, the yellow area is ALARP zone which means the risks which are in these areas should be as low as possibly practical which means if a risk mitigation measure exists it should be implemented as long as it is economically beneficial otherwise, the system can work with the existing risk. The red area is the unacceptable risk zone which must be reduced using barriers.

Frequently (once per month)			H1		
Likely (once per year)			H2-H3	H6	H5
Quite unlikely (once per 10 year)					H4
Unlikely (once per 100 year)					
Very unlikely (less than once per 1000 year)					
Probability/consequences	Negligible (less than occupational malfunction)	Minor (occupational illness)	Marginal (operational damage)	Critical (severe malfunction and damage)	Catastrophic (death or system loss)

Table 5 - risk matrix before mitigating barriers

It can be seen that all the risks involved in 3D printing process are in the unacceptable zone thus, they must be reduced using mitigating barriers. Below the risk matrix after implementing the mitigation methods is presented in table 6.

Frequently (once per month)					
Likely (once per year)					
Quite unlikely (once per 10 year)					
Unlikely (once per 100 year)	H1-H2	H3	H6	H5	
Very unlikely (less than once per 1000 year)					H4
Probability/consequences	Negligible (less than occupational malfunction)	Minor (occupational illness)	Marginal (operational damage)	Critical (severe malfunction and damage)	Catastrophic (death or system loss)

Table 6 - Risk matrix after mitigating barriers

It can be seen that if the barriers applied H1, H2 and H3 would be in the acceptable risk zone so the system can function well with these hazards. H6, H5 and H4 are in the ALARP zone so if there is any other mitigation method available it should be applied otherwise, the risks will be accepted, and the system will work with the existing risks.

In this thesis the WINDTECH device outer shell and honeycomb used to stabilize the flow field in the cold box used for experiments were 3-D printed which will be explained in more details later.



## 3 Methodology

In this chapter the project conducted prior to this thesis, the methodology implemented for the thesis, equipment used for carrying out experiment will be explained.

### 3.1 Pre-projects

In advance of this thesis, a project carried out in relation to the thesis. The project found a relation to measuring the wind velocity using pressure difference values.

#### 3.1.1 Pressure difference, wind velocity and ambient temperature analysis

In the project, a pressure sensor was installed on a circuit board and another pressure sensor was attached to the board to measure the reference pressure. Board setup can be seen in figure 9.

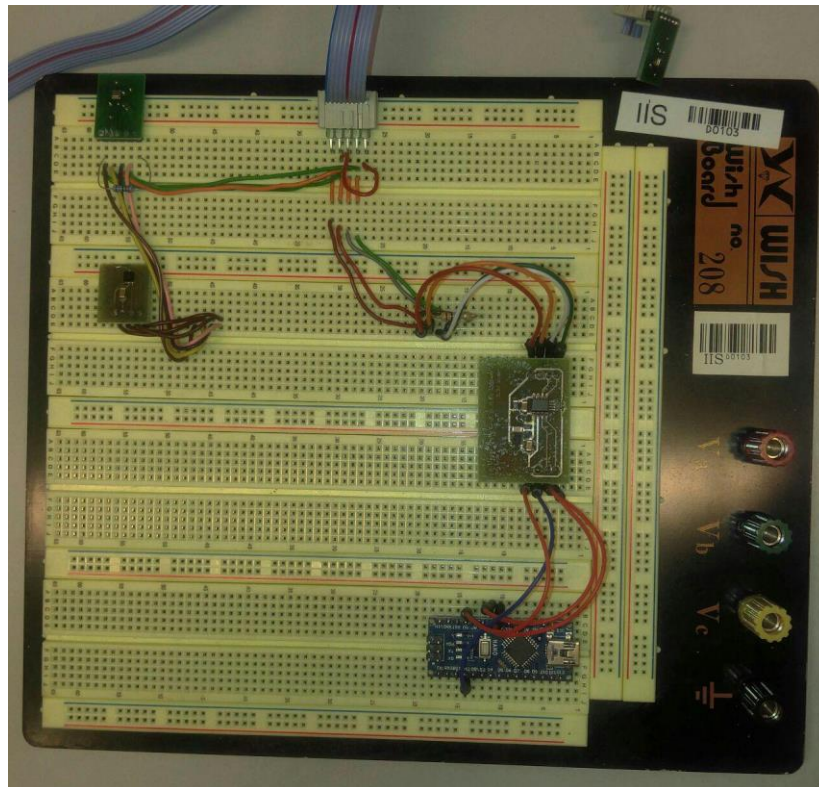

Figure 10 - Board setup

To find the relation between pressure and wind velocity a hair dryer was used to control the wind velocities was being blown to the sensor. The wind was controlled with a voltage regulator and varied from 1 m/s to 7 m/s. The wind was blown to the pressure sensor from the top and side direction (figure 11, 12). The reference pressure sensor also been tested in the cold box and out of the cold box. The difference of the averages for pressure sensor on the board and reference pressure values used to make an estimation of wind velocity being blown to the sensors.



*Figure 11 - Side wide direction*



*Figure 12 - Top wind direction*

In the both wind directions, the reference pressure sensors were put into a box for protection from wind. In each wind direction experiments ambient temperatures varied from -5 to -45. Figures 13 and 14 shows how wind velocity changes with pressure difference values. In the case of top wind, the pressure difference increases with higher wind velocities, but side wind causes lower pressures on the pressure sensor thus, the plots are showing a decrease in the wind velocities.

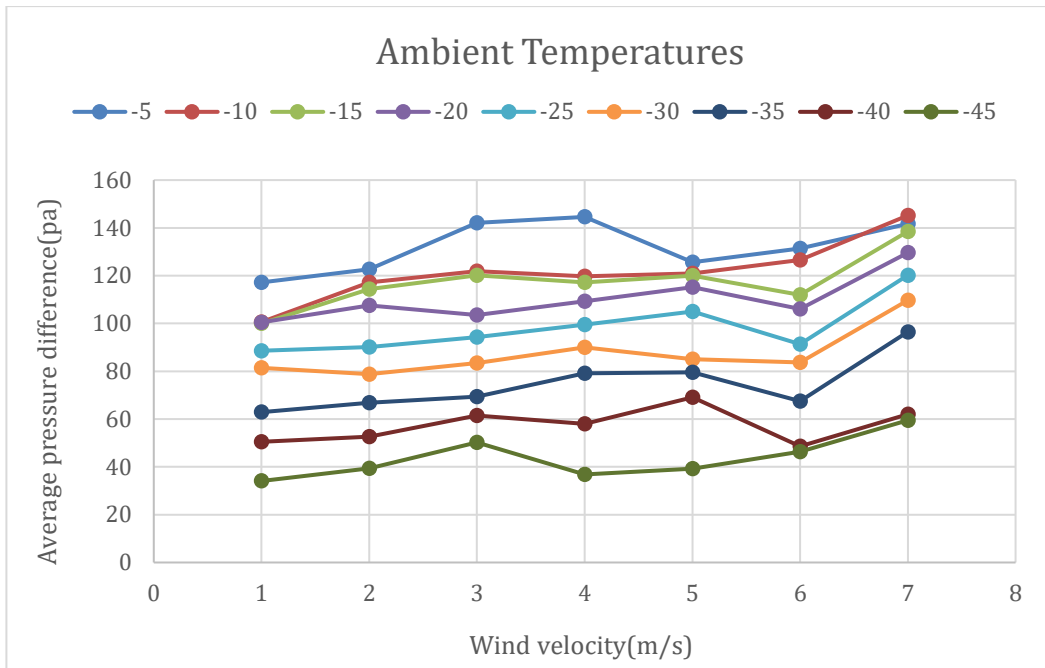

Figure 13 - P, V and ambient temperatures (top wind, ref inside)

Figure 13 illustrates how pressure difference changes with velocity in different ambient temperatures the graph been plotted for the data regarding the reference pressure sensor **inside** the cold box and wind blowing from the **top** to the main sensor. The total trend is positive in this case, which indicates the pressure difference increases with wind speed. If this graph compared with figure 24 which is related to the same scenario but with the reference pressure out of the box it can be seen that the distances between each ambient temperature is bigger that indicates the higher differences in the average pressure difference when the reference pressure is out of the cold box.

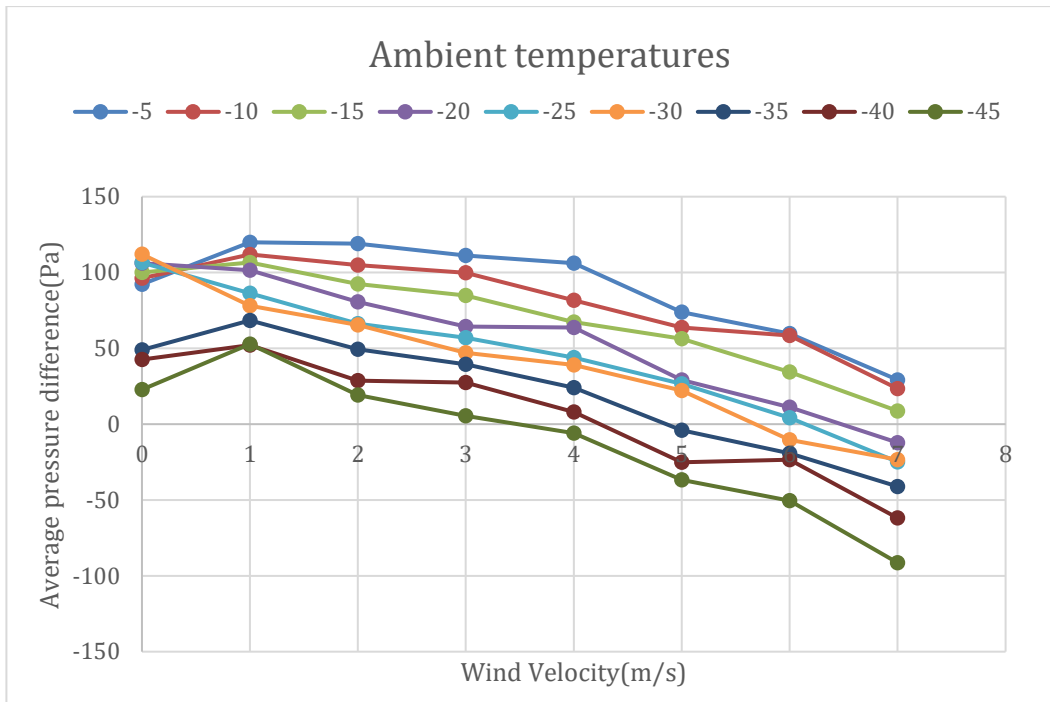

Figure 14 - P, V and ambient temperatures (side wind, ref inside)

Figure 14 shows the graphs regarding the reference pressure sensor **inside** the cold box. What stands out from this graph is that the negative trend is due to wind blowing to the main sensor from the **side** which causes a decrease in the pressure compared to the reference pressure not exposed to the wind from top. The graphs in this case are closer to each other compared to figure 25 which relates to the same condition but with the reference pressure sensor out of the cold box.

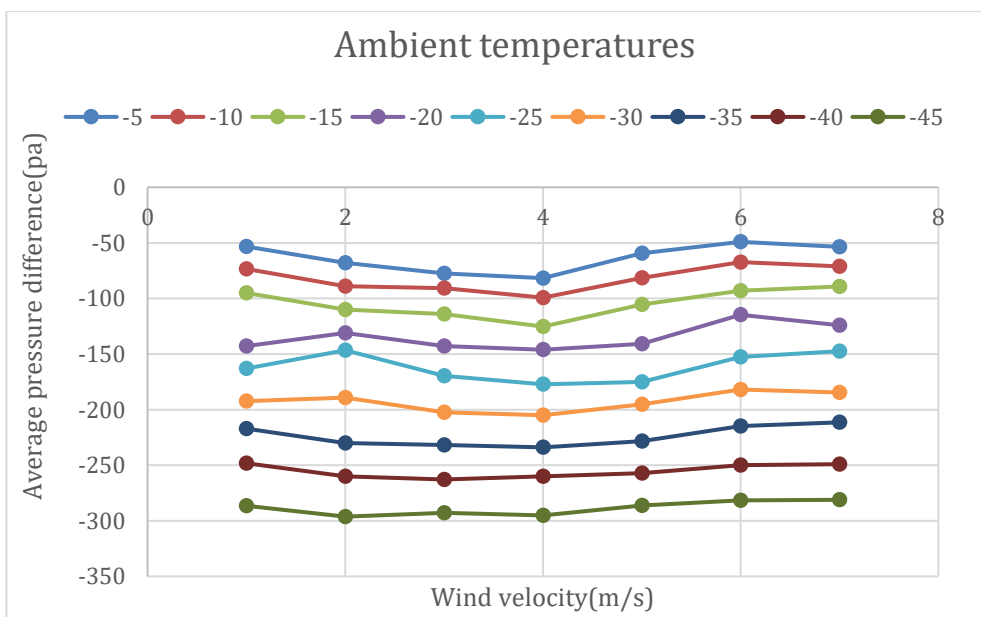

Figure 15 - P, V and ambient temperatures (top wind, ref outside)

Figure 15 depicts the pattern in which wind velocity changes with pressure difference in different ambient temperatures. This graph been plotted for the experiments regarding the reference pressure **out** of the cold box and wind blowing from the **top** to the main sensor. The graphs are further from each other that shows the average pressure difference is higher compared to the case which reference pressure is inside the cold box as it has been shown in figure 13.

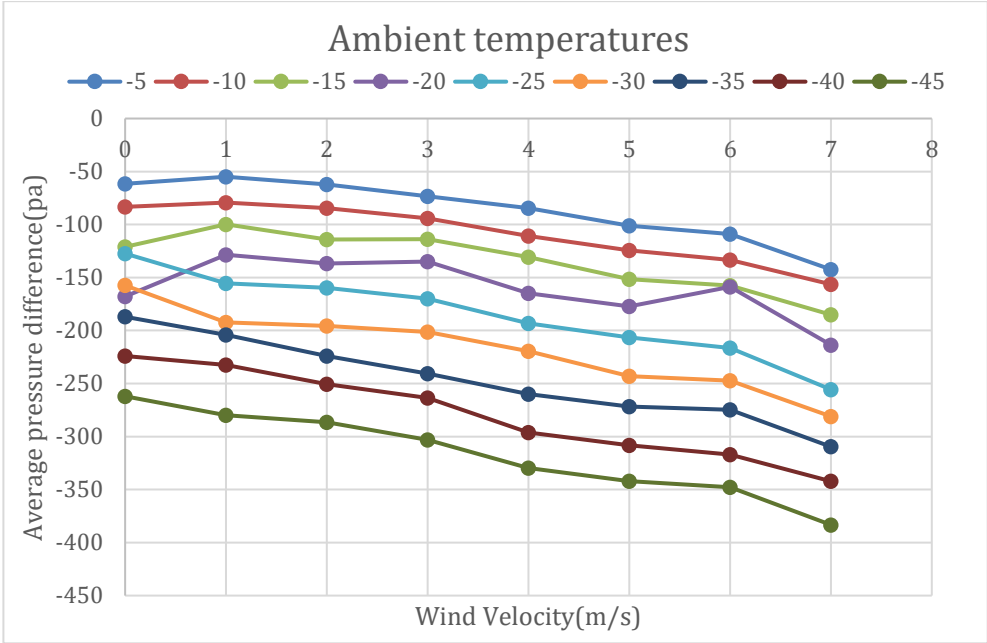

Figure 16 - P, V and ambient temperatures (side wind, ref outside)

Figure 16 shows how pressure difference changes with different wind velocities in various ambient temperatures. The graph been plotted with the data collected from the experiments regarding the reference pressure **out** of the cold box and wind blowing to the main sensor the **side**. The downward trend in the graphs depicts the decrease in pressure due to wind being blown to the sensor from the side. The distances between each graph for different ambient temperatures are higher in comparison to the figure 13 due to reference pressure sensor situated out of the cold box.

### 3.1.2 Wind velocity and pressure difference relation

In this part the graphs for pressure difference as a function of wind speed is presented using the graphs and the data collected for each ambient temperature a linear relation established with a specific constant and certain error of  $R^2$ . The relation is shown in each graph for every ambient temperature as  $y = ax + b$  which  $y$  is pressure difference and  $x$  is wind velocity. Four graphs for the ambient temperature of -5 for the cases of **top** wind and **side** and reference pressure being **inside** and **outside** the cold box will be presented in this part and the rest is in **APPENDIX I**.

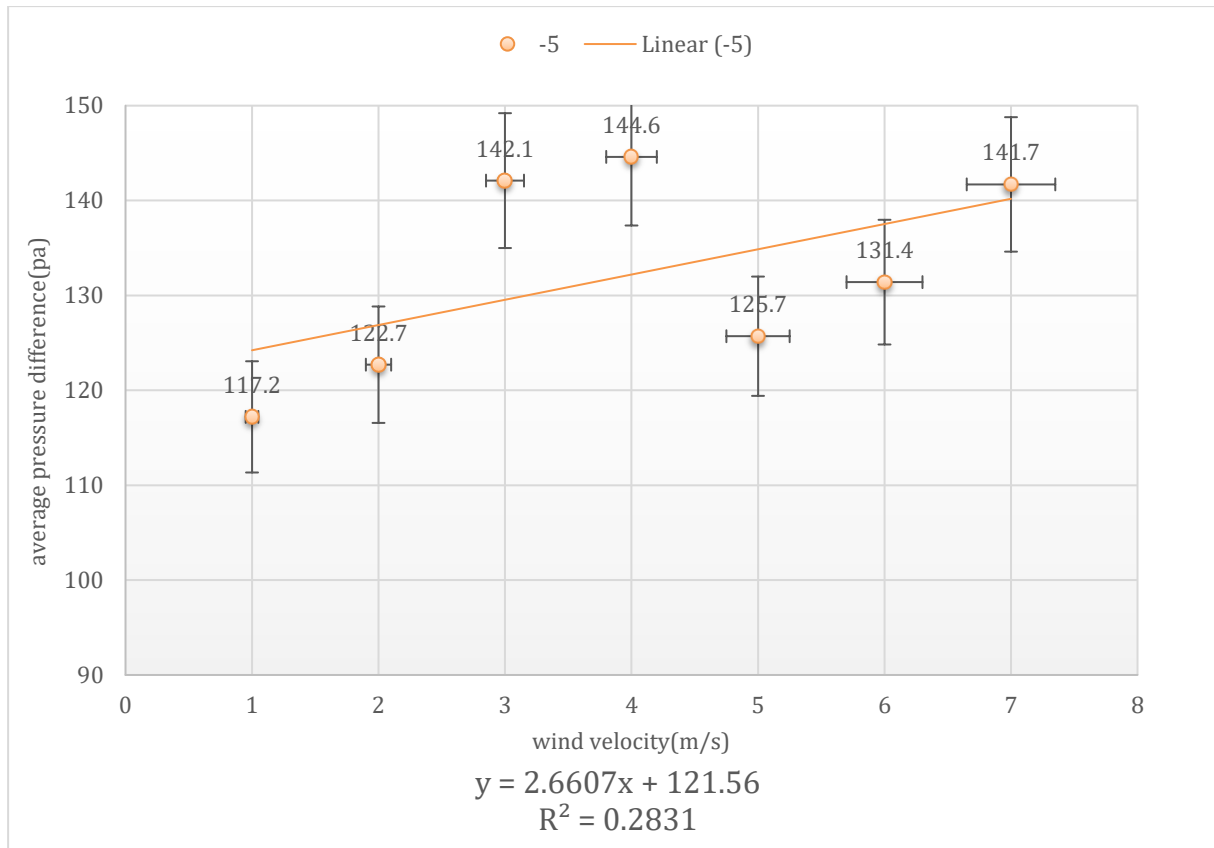

Figure 17 - P & V relation for -5° (top wind, ref inside)

Figure 17 presents the graph for pressure difference and wind velocity in ambient temperature of **-5** degrees of Celsius for the case of wind blowing from the **top** to sensor and reference pressure sensor being **inside** the cold box. The wind speed can be calculated with having the pressure difference value as  $y$ .  $R^2$  is the error value which indicates the wind speed calculated using the equation can have 2.8% error in this case. The line has a positive gradient due to direction of wind. The wind being blown from the top to sensor causes higher pressure on the main sensor in comparison to the reference sensor not exposed to wind.

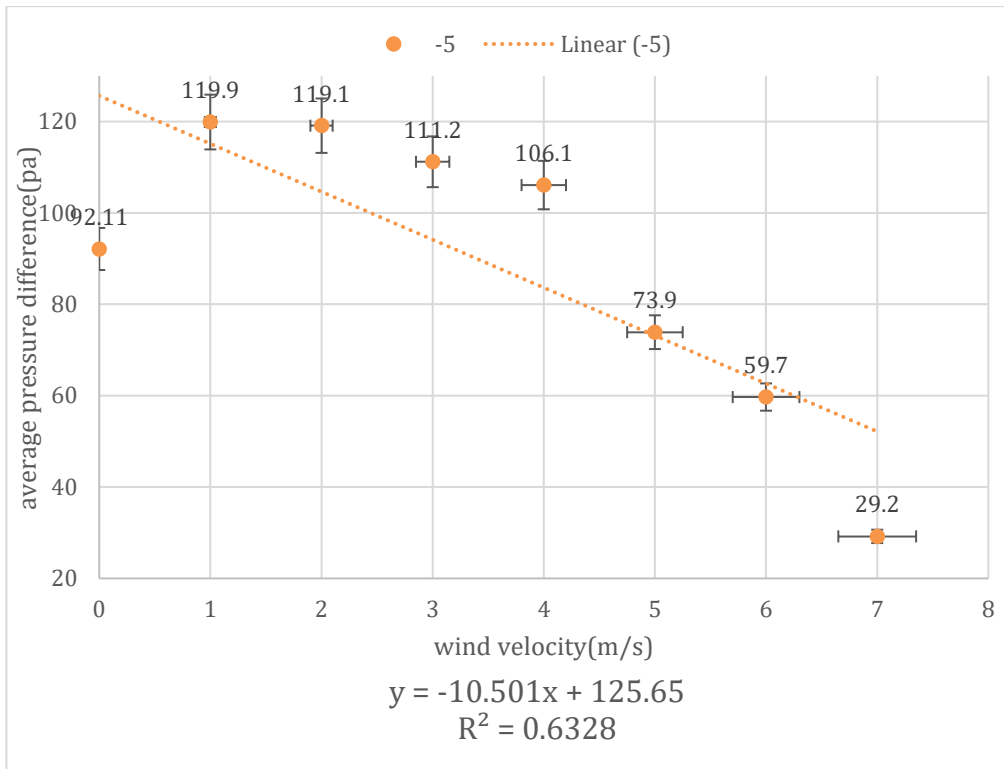

Figure 18 - P & V relation for -5° (side wind, ref inside)

Figure 18 presents the graph for pressure difference and wind velocity relation in ambient temperature of -5. The graph has negative gradient due to wind blown to sensor from the side which causes lower pressures compared to reference pressure. The relation between pressure difference and wind velocity is presented in the graph with error value of  $R^2 = 0.6328$ .

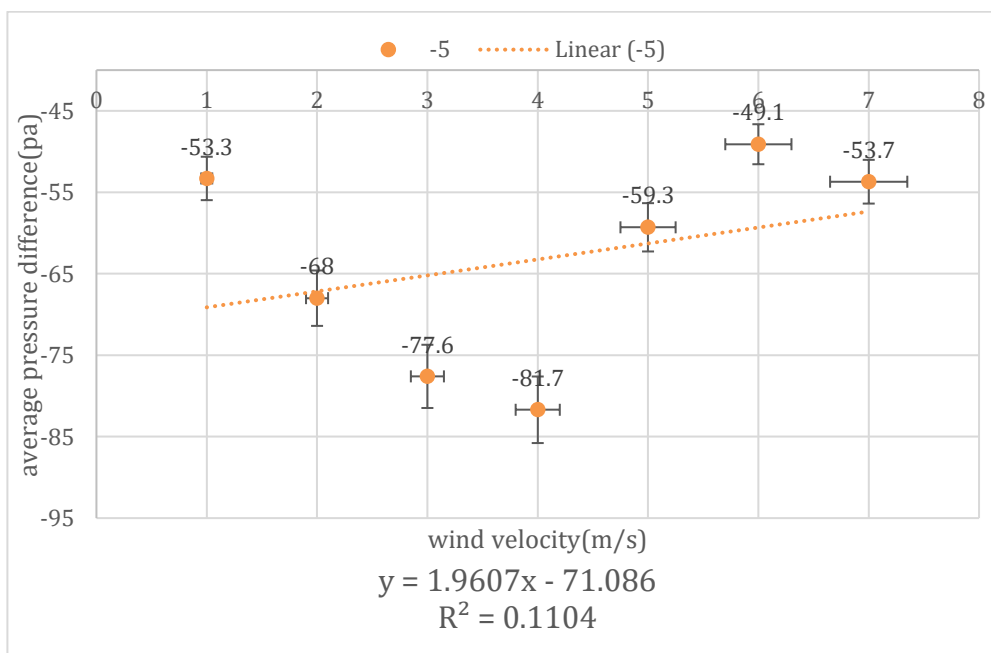

Figure 19 - P & V relation for -5° (top wind, ref outside)

Figure 19 shows the graph for pressure difference and wind velocity relation in the ambient temperature of -5 degrees in can be seen that the due to wind blown to sensor from top the gradient of the line is positive showing the pressure increase due to wind direction.

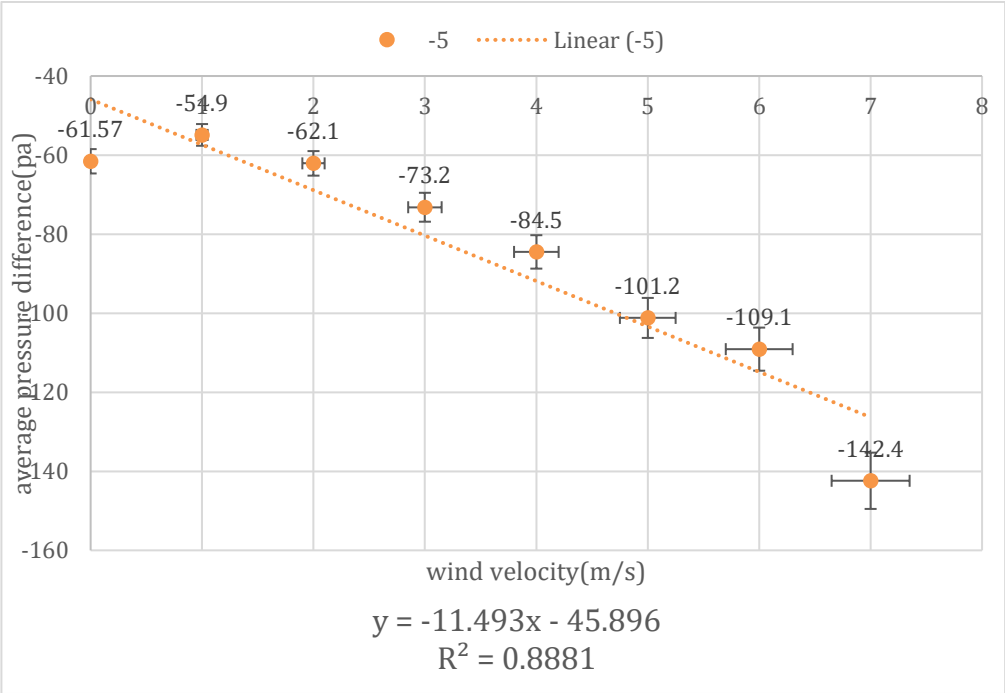

Figure 20 - P & V relation for -5° (side wind, ref outside)

Figure 20 illustrates the relation between average pressure difference and wind velocity in the ambient temperature of -5 degrees the gradient is negative for the line presenting the function since the wind was blown to the sensor from the **side** and caused a decrease in the main sensor pressure in comparison to reference pressure which is **out** of the cold box.

**3.1.3 Pressure, wind velocity and ambient temperature relation**

In the experiments it was chosen to have two different situations for the reference pressure sensor (1) outside the cold box and (2) inside the cold box and protected from wind using a cartoon box. It can be said that the sensors are quite sensitive to this change since the distance between each graph for different ambient temperatures changed in these two cases. The distances were bigger when the reference pressure was out of the cold box which indicates the pressure differences are higher compared to the case with reference pressure sensor inside the cold box.

The wind was blown to the sensor from top and side. The results showed that wind blowing from the top to sensor will increase the pressure to a certain extent in each ambient temperature and wind blowing from side to the sensor will decrease the pressure.



Choosing different ambient temperatures showed that the pressure is also sensitive to ambient temperature. The pressure decreases with lowering the ambient temperature as it is expected the viscosity of air changes with temperature which lead to decrease in pressure.

After they analysis and examining the graphs it can be concluded that:

- Pressure is sensitive to ambient temperature and the pressure difference increases with higher wind speeds and decreases with lower wind velocities.
- Pressure difference changes with ambient temperature in which it increases with higher ambient temperatures and decreases with lower ambient temperatures.
- A linear relation can be established for pressure difference and wind velocity.
- Wind velocity can be calculated using the linear equation, by knowing the pressure difference in any condition the wind velocity can be calculated for a certain ambient temperature.
- Wind direction affects the pressure difference in which the pressure difference is negative when wind blowing from side and it is positive when wind is blowing from top.
- The biggest challenge in finding the heated temperature or the real feel temperature is unknown values of wind speed however, it can be calculated knowing the other parameters values such as: ambient temperature and pressure difference
- With knowing all the parameters affecting the heated temperature it can be calculated implementing the values of wind velocity, humidity, ambient temperature and irradiance.
- Heated temperature can be further used as basis for developing a risk management program for workers operation conditions in cold climate.

### **3.2 Device setup, design and prototyping**

The device was designed by WINDTECH team in advance of this thesis. The device is designed to gather ‘cold’ sensation associated parameters. It can be attached to the uniforms humans wearing in the cold climate working condition or can be installed where the local ‘cold’ sensation is of importance such as cruise ships, wind farms or oil platforms, etc. The device outer and back shell is prototyped by a desktop 3D-printer at the University of Tromsø. The device is equipped with temperature, humidity, pressure, irradiance and ‘heated temperature’ sensor. The irradiance sensors are installed with 45 degree angle from the horizontal and vertical direction to absorb the lights as most as possible. The device is also equipped with a small display which shows data logging status, battery voltage, and battery ampere. The black button at the side turns data logging on and off with keeping the button for 7 seconds. The red button is the device power on and off button. The device has a memory stick for saving the data and can be connected to a computer via USB cable to extract the data.

### 3.2.1 Sensors on the device

The device is equipped with seven sensors in total. Three BME280 sensors on each side of device measure ambient temperature, humidity and pressure (sensors 0, 1 and 3) also a same sensor is installed inside (sensor 2) the device to measure reference pressure. Two Si1145 light sensors on the edge of the device collect irradiance data and Si7020 is implemented with a heater to collect 'heated temperature' values.

**BME280:** This sensor is a combined humidity, pressure and temperature sensor. It can be used for context detection, health monitoring, smart homes, GPS modification, weather forecast and vertical velocity measurements. Figure 20 shows a simplified block diagram of BME280 sensor (Bosch, 2014).

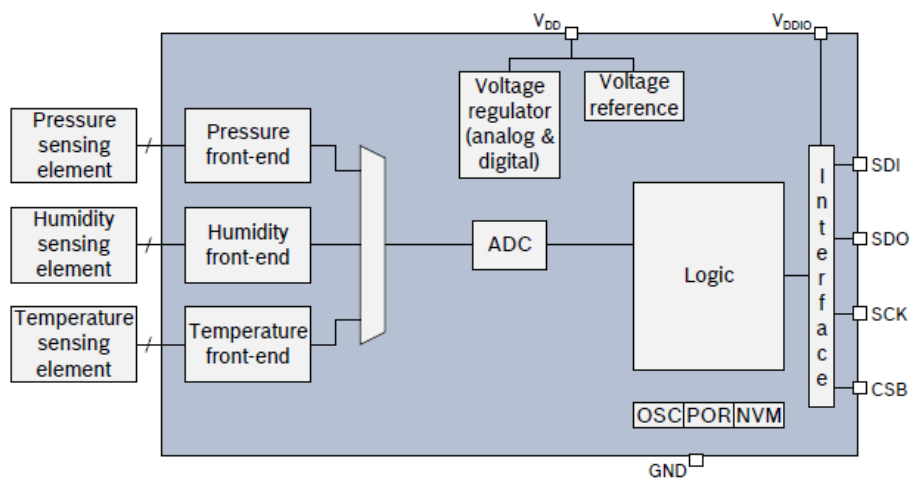

Figure 21 - BME280 block diagram (Bosch, 2014)

**Si1145:** The Si1145 is an ultraviolet (UV), low-power, reflectance-based, infrared proximity, and visible light sensor which is programmable. This sensor has an analog to digital converter and highly sensitive visible and infrared photodiodes. It can be used in smoke detectors, electronics, automation, dispensers, etc. (LABS, 2014). The sensor's block diagram is shown in figure 21.

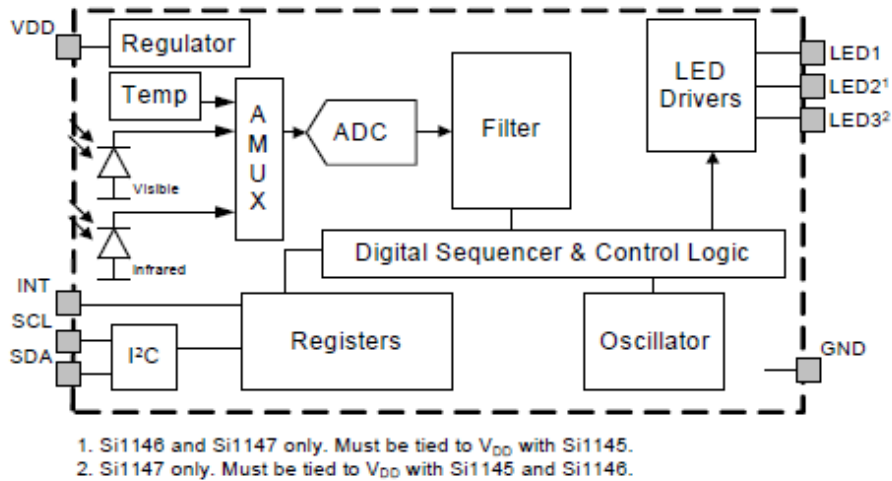

Figure 22 - Si1145 block diagram (LABS, 2014)

**Si7020:** This sensor is a combined humidity and temperature sensor. Its applications can be mentioned in thermostats, white goods, indoor weather stations, electronics, etc (LABS, 2016). The functional block diagram of this sensor is illustrated in figure 23.

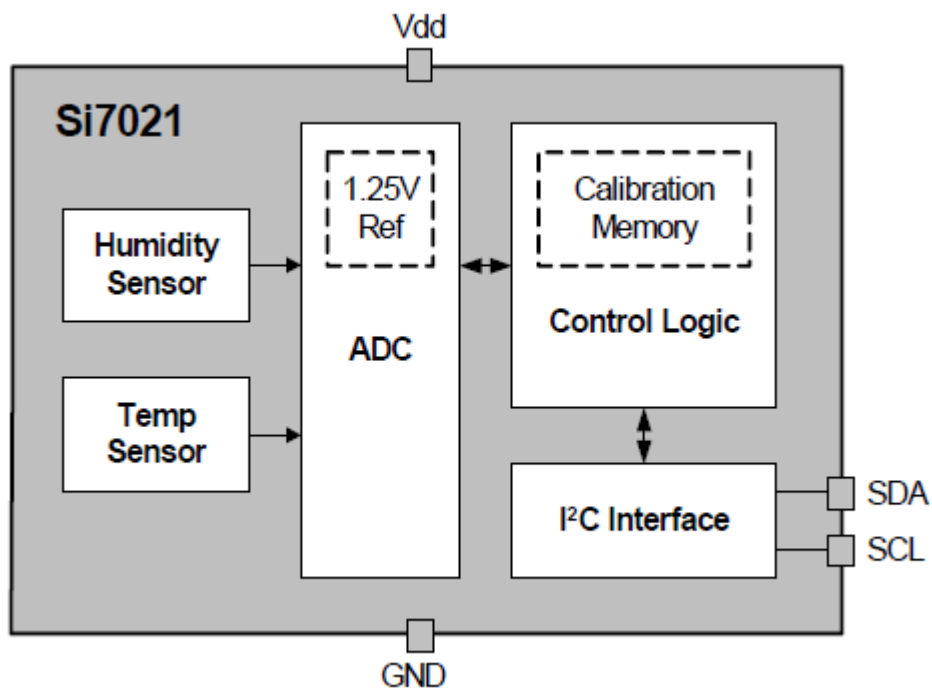

Figure 23 - Si7020 sensor block diagram

All sensors are factory calibrated and the calibration data is stored in the non-volatile memory and they do not need recalibration.

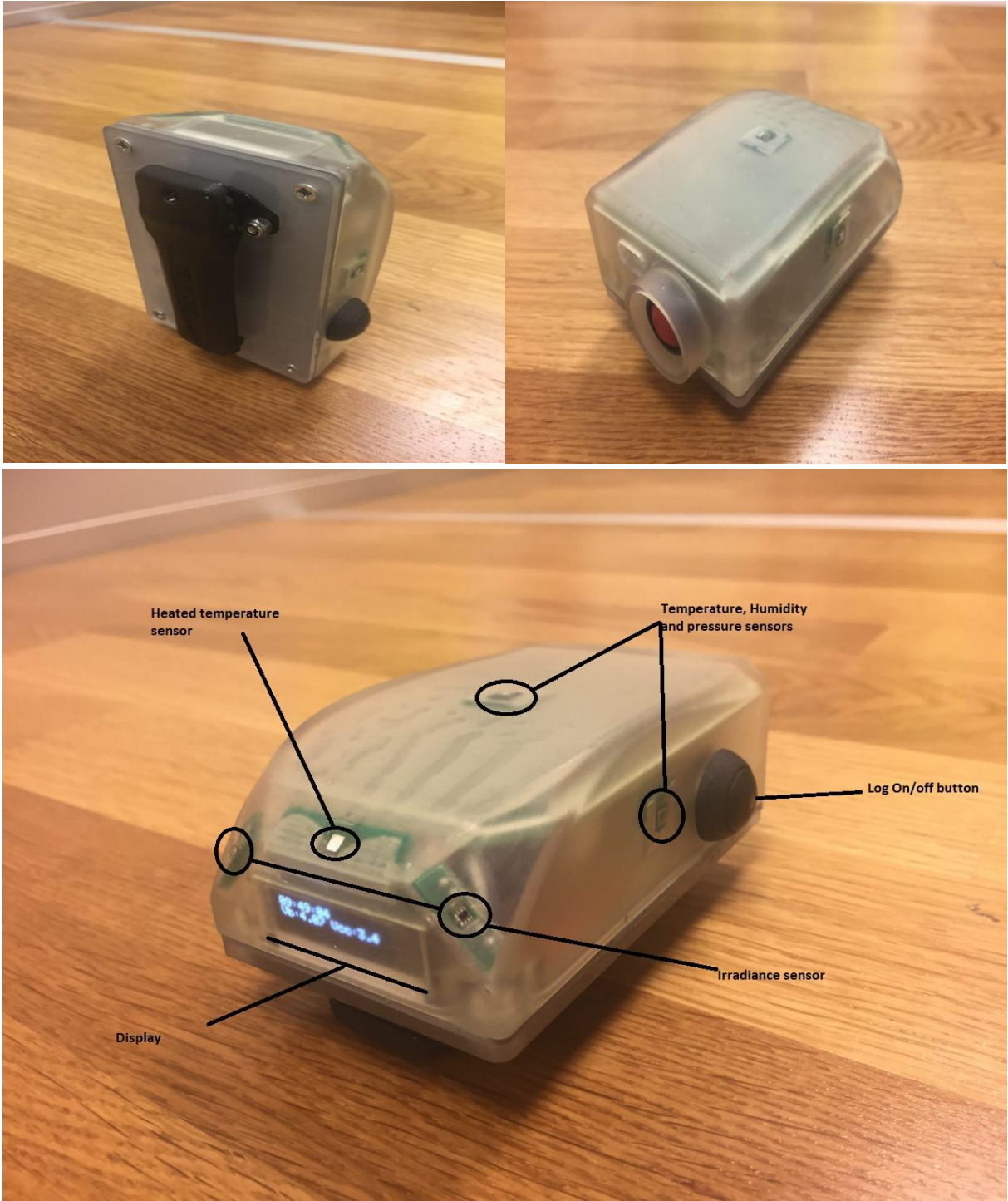

Figure 24 - WINDTECH device

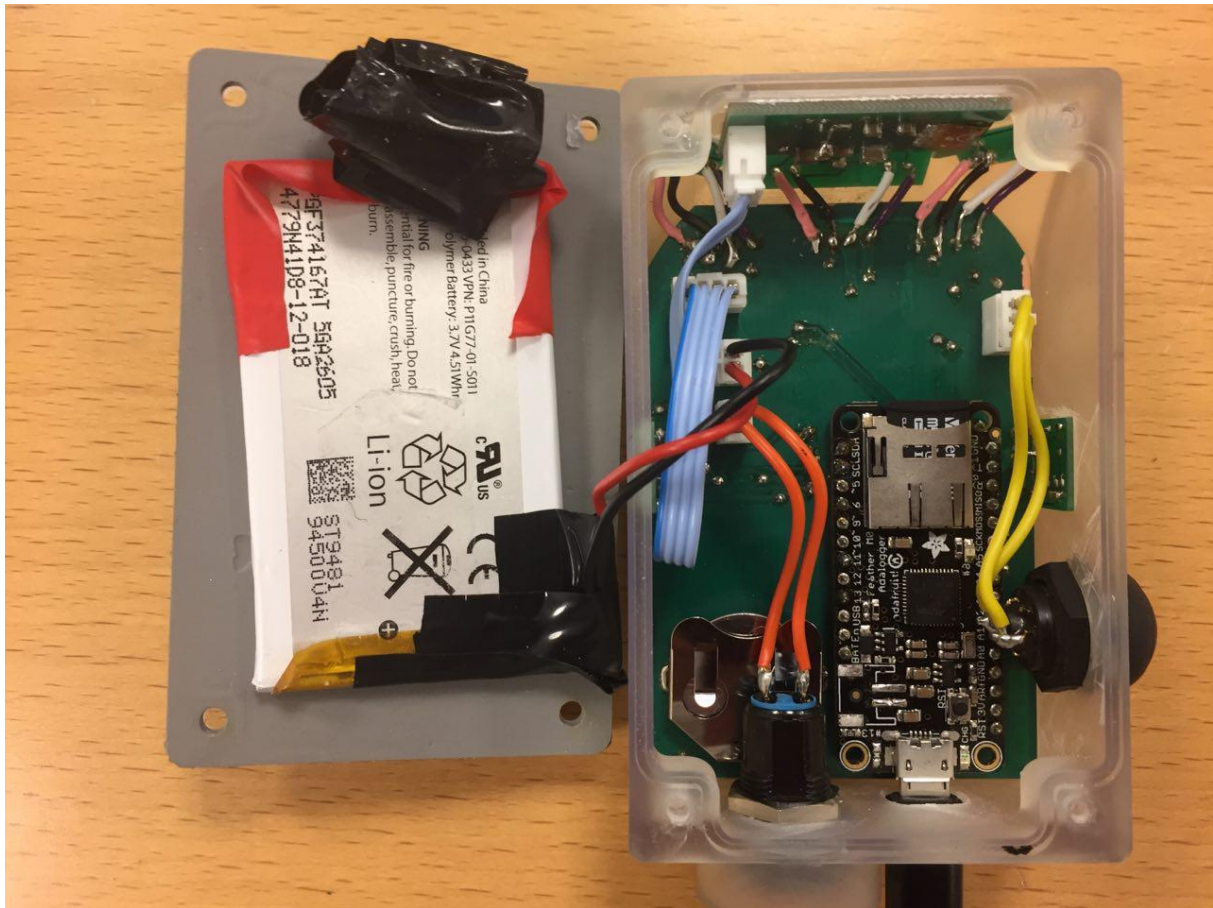

Figure 25 - WINDTECH device internal parts

### 3.2.2 Battery life

The battery used on this device is Li-Ion 1440 mAh. The battery showed a good performance. During field tests the device survived more than 48 hours and in the cold box test the device had no problem functioning in minus degrees up to -45 degrees Celsius.

## 3.3 Data collection

Data collection consists of all the procedures that had been followed to conduct the experiments in the lab with different conditions and gather the data in the field.

### 3.3.1 Lab experiments

The lab experiments were carried out in the safety lab at the Arctic University of Norway. All the experiments were done inside a cold box which is a heating machine that can be used both for heating and cooling. The cold box has a nominal range of -108.1 to 198.2 Celsius degrees. The temperatures used to test the device were from 0 to -45 degrees of Celsius. The device was put in a carton box inside the cold box. The device was tested in three different humidity condition, four different irradiance condition and four wind velocities in temperatures from 0 to -45 degrees Celsius with 5 degrees difference for each experiment therefore 432 readings on data has been done. For each reading, the

waiting time to gather the data was at least 25 minutes. The device needs some time to stabilize at each temperature therefore, after each change in temperature and wind velocity the waiting time to collect the data was 45 to 60 minutes.



Figure 26 - Cold box

### 3.3.2 Field experiments

The field tests were done in the open environment in Tromsø and Svalbard where the weather conditions are cold, and it is a realistic condition that usually humans working in the cold climate are exposed to. Field tests were conducted during March, April and May 2019 in 42 different days and in various weather conditions to consider different values of ambient temperature, pressure, wind velocity, humidity and irradiance in real. The field tests were done by putting the device in an open space to collect the data over longer periods of time.



*Figure 27 - Field test in Svalbard*

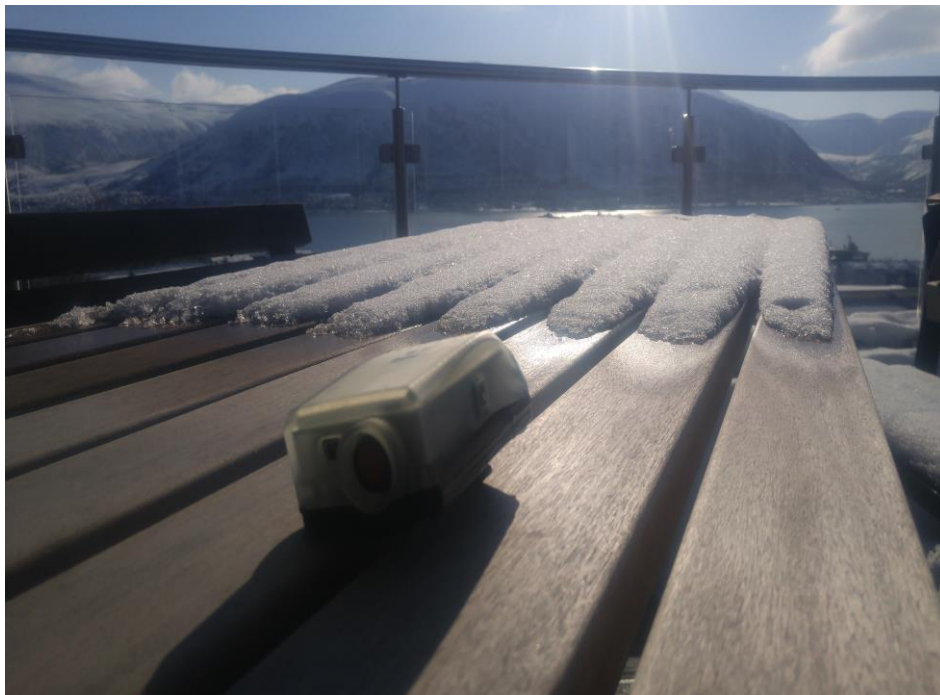

*Figure 28 - Field test in Tromsø*

### **3.3.3 Meteorological data**

To compare the field tests with meteorological data provided by weather stations they also gathered each time the device was tested in the field. Meteorological data were gathered from [www.yr.no](http://www.yr.no)

webpage. Yr database is reported based on weather stations located in Tromsø. The meteorological data is available in appendix II.

### 3.3.4 Equipment

To carry out the experiments in the lab various equipment were used. Each equipment has its own functionality and purpose and helped getting more accurate and reliable results. The equipment used are described below.

**Cardboard box:** to have a consistent and unchanged flow field inside the cold box and better control on wind velocity blown to device and sensors a carton box was used. In all the lab experiments the device was put in the carton box and inside the cold box beside other equipment used to control humidity and irradiance.



*Figure 29 - Cardboard box and other equipment in the cold box*



**Fans:** a big fan on one end of the carton box is used to control the wind velocity. The fan is attached to a voltage regulator and fan speed can be changed. Another fan is put in front of the main fan and it is attached to an anemometer to monitor the wind velocity on the device.



*Figure 30 - Fans*

**3-D printed honeycomb:** a honeycomb shaped entrance is used on the other end of the box to make it possible for the fan on the other side of the carton to suck the cold box air in the carton box and make the wind blowing situation on the device.

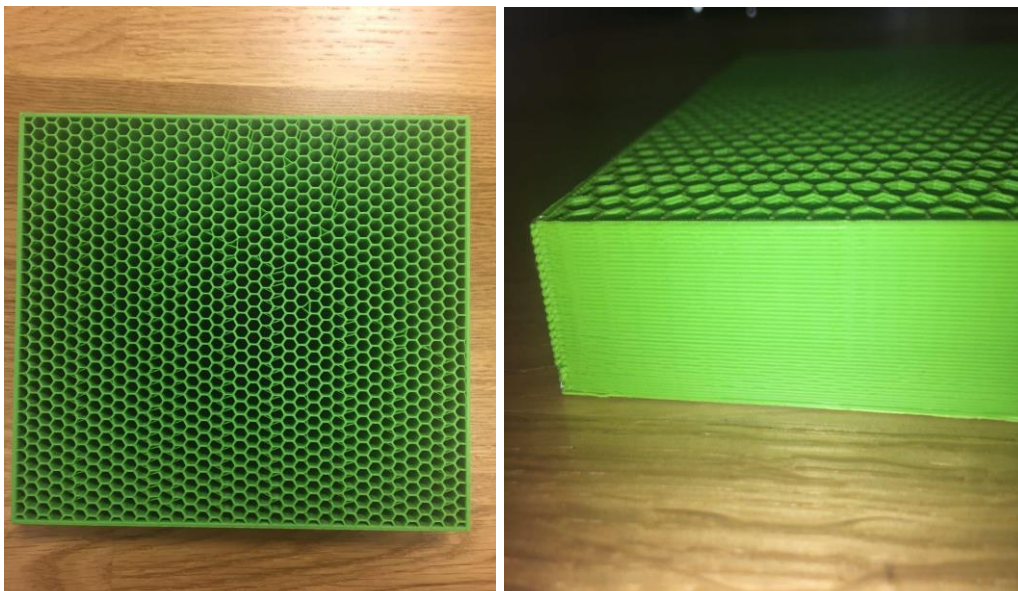

*Figure 31 - Honeycomb used in carton box air entrance*

**Halogen light:** a halogen light bulb was used to control the irradiance. It was attached to a voltage regulator. The voltages used were 0, 6, 9, and 12 volts.

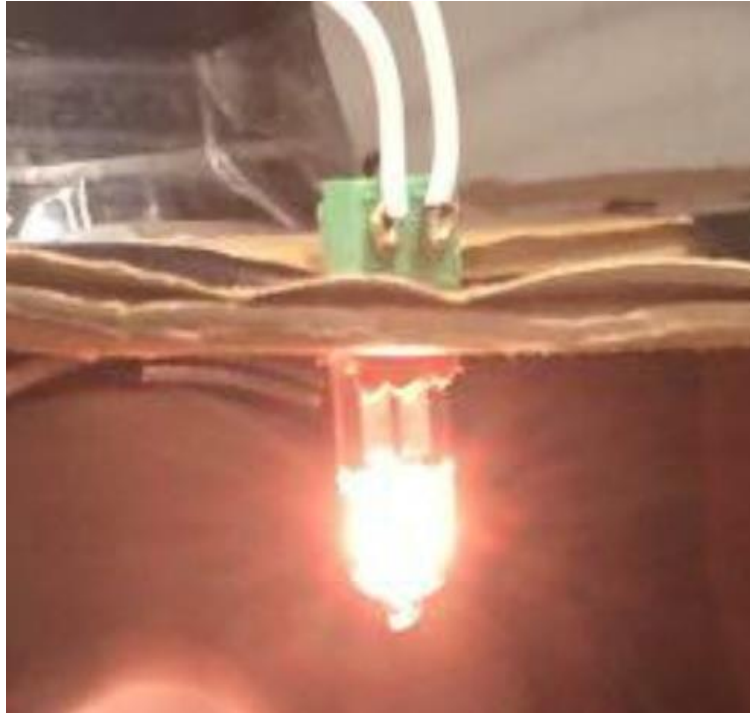

Figure 32 - Halogen light

**Cups of water:** two small cups filled with water were put inside the carton box beside the device to control the humidity.

**Voltage regulator:** a voltage regulator was implemented to control the light on the halogen light bulb.

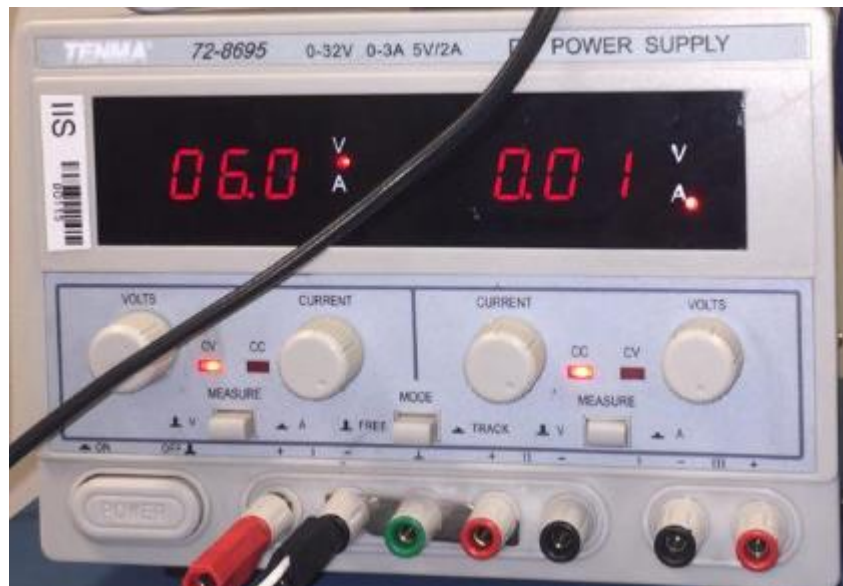

Figure 33 - Voltage regulator

**Anemometer with regulator:** an anemometer was attached to a fan with a sensor to monitor the wind velocities blown on the device.



*Figure 34 - Anemometer and regulator*

### **3.3.5 Termite**

Prior to this thesis the codes needed to collect the data from the device board were uploaded to Aurdino. Termite is software which is used to extract the data. The codes uploaded to Aurdino makes some certain commands available in Termite. The time and date can be changed. The heater's active and passive time can be set which means the time the heater is on and off can be changed. The command 'LISTFILES' shows all the files been stored in the device memory and command 'PRINTFILENAME' prints all the collected data on a certain time and data. The codes have been designed to gather and save data in each hour, so each file is referred to every exact time. All the experiments have been done using sixty second active time and five hundred and forty seconds for the time the heater stops working. For some experiments it was chosen to increase the time heater is working to 120 seconds. In this case, the battery is drained more, and the device showed about 24 hours of life. The higher active time leads to better stabilization of 'heated temperature' therefore the data would be more accurate however it decreases the battery life and also risks the failure of the sensor due to overheating.

### Serial port settings

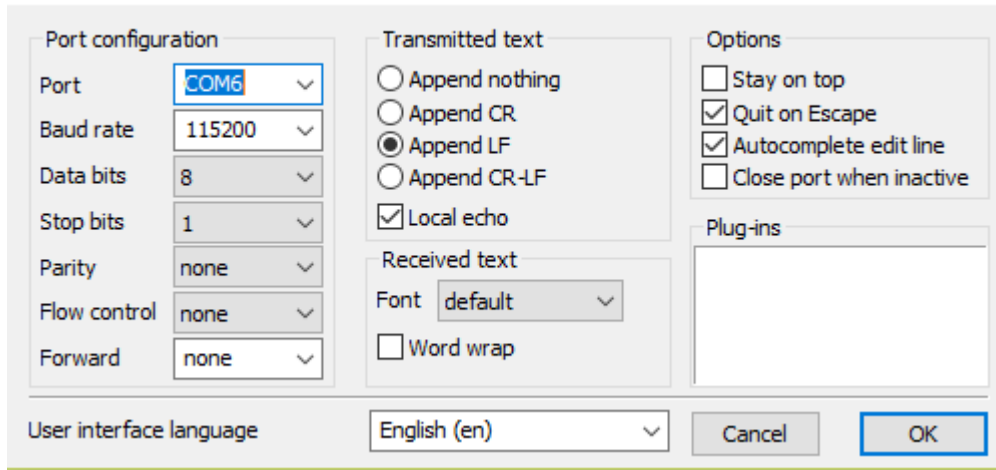

Figure 35 - Termit software settings

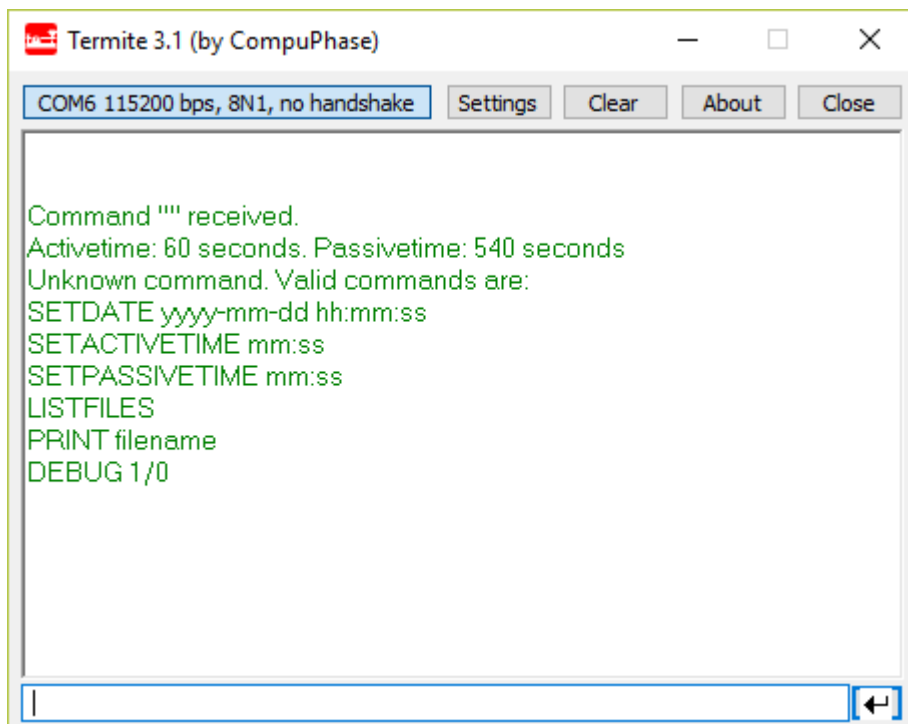

Figure 36 - Termit commands and main page

An example of raw data is attached in appendix III.

### 3.3.6 Ambient temperature

The ambient temperature in the field tests could not be controlled thus, the ambient temperature data collected by device sensors and the ambient temperatures of meteorological data is implemented for analysis. Since, the device is focused on humans exposure to cold the minus degrees temperatures were of focus therefore, in the cold box tests the ambient temperatures were varied from 0 to -45 degrees Celsius with 5 degrees interval. The cold box nominal ambient temperature showed about 4 degrees difference from the temperatures that gathered by device.

### **3.3.7 Velocity**

In the lab tests, the wind was blown to the device using a fan. According to the orientation of the device in the carton box, the wind is blown over all sensors from the side. The fan speed is controlled by a regulator. Another fan was put in front of the main fan and it is attached to an anemometer to monitor the wind velocity. The wind velocities varied from 0 to 4 m/s due to average wind speed in the Arctic which is average 4 m/s second during a year. In the field tests the wind velocity provided by meteorological data and estimated wind velocity based on pressure difference values collected with the device can be compared.

### **3.3.8 Pressure**

Pressure values are collected in the device implementing three sensors on each side of the device's outer shell and a sensor inside the device to obtain reference pressure values. The wind velocity being blown to each sensor can be estimated by the difference of pressure on each sensor and reference pressure values. Since, the wind was blown to sensors from the side a decrease in pressure is expected.

### **3.3.9 Humidity**

The humidity on the lab experiments was changed to two different ones. (1) default humidity of the cold box (not putting any equipment in the carton box), (2) changing the humidity by putting two cups of water inside the test box. In the field test, the meteorological data and the humidity data collected by sensors can be compared.

### **3.3.10 Irradiance**

In the field tests, the irradiance data which includes infrared, ultraviolet and visible light values were collected by the device and it can be compared with values from meteorological data. In the cold box tests the irradiance was controlled by a LED light. The voltages used to change the irradiance was 0, 6, 9 and 12 volts.



## 4 Results and discussion

In this chapter, the results obtained from data collection and analysis in the field, lab and meteorological data is discussed using graphs and tables.

### 4.1 Data analysis

The data collected by the device were transferred to a text document and further transferred to Excel for the analysis. The thesis is focused on finding a relation between ‘heated temperature’ and its associated parameters wind velocity, ambient temperature, humidity and irradiance. The ‘heated temperature’ graphs are plotted using MATLAB code and the other plots been drawn by Excel.

time	bme0_hum	bme0_press	bme0_temp	bme1_hum	bme1_press	bme1_temp	bme2_hum	bme2_press	bme2_temp	bme3_hum	bme3_press	bme3_temp	light0_uv	light0_ir	light0_vis	light1_uv	light1_ir	light1_vis	s77021_temp	vbat	vcc
9:58:09 AM	40.68	100354.07	-9.77	39.8	100194.11	-9.85	28.55	100163.94	-7.68	42.97	100083.12	-9.91	0.03	252	260	0.03	252	262	4.02	3.88	3.4
9:58:10 AM	40.69	100348.59	-9.77	39.83	100202.86	-9.85	28.56	100148.19	-7.68	42.98	100101.23	-9.91	0.04	251	264	0.02	254	261	10.41	3.8	3.4
9:58:11 AM	40.67	100352.75	-9.78	39.87	100199.48	-9.85	28.55	100151.61	-7.68	42.99	100099.11	-9.91	0.03	252	262	0.03	253	262	16.24	3.8	3.4
9:58:12 AM	40.62	100358.95	-9.78	39.83	100196.14	-9.86	28.55	100193.35	-7.69	43	100091.95	-9.92	0.03	251	262	0.02	252	260	19.85	3.8	3.4
9:58:13 AM	40.72	100348.89	-9.78	39.83	100198.2	-9.86	28.56	100154.29	-7.7	43.01	100088.61	-9.92	0.02	252	261	0.03	252	262	22.39	3.68	3.4
9:58:14 AM	40.72	100358.95	-9.78	39.88	100204.84	-9.87	28.56	100162.03	-7.71	43.03	100085.23	-9.93	0.02	252	261	0.03	253	262	24.41	3.79	3.4
9:58:15 AM	40.69	100352.17	-9.79	39.88	100204.4	-9.87	28.56	100162.52	-7.71	43.03	100090.7	-9.93	0.03	252	262	0.03	253	262	26.06	3.8	3.4
9:58:16 AM	40.67	100354.2	-9.8	39.89	100204.78	-9.87	28.57	100170.19	-7.71	43.04	100088.2	-9.94	0.03	251	263	0.02	253	260	27.46	3.8	3.4
9:58:17 AM	40.75	100343.26	-9.81	39.9	100195.16	-9.88	28.57	100149.77	-7.72	43.06	100100.39	-9.94	0.03	253	262	0.02	253	261	28.69	3.79	3.4
9:58:18 AM	40.75	100350.8	-9.81	39.96	100198.03	-9.88	28.58	100141.73	-7.73	43.07	100102.92	-9.94	0.02	253	261	0.02	252	262	29.75	3.79	3.4
9:58:19 AM	40.82	100356.57	-9.82	39.92	100209.28	-9.88	28.57	100153.25	-7.73	43.08	100097.45	-9.94	0.03	252	262	0.02	252	261	30.74	3.79	3.4
9:58:20 AM	40.85	100352.36	-9.82	39.86	100205.48	-9.89	28.58	100161.35	-7.73	43.11	100097.88	-9.96	0.03	250	262	0.02	254	260	31.63	3.79	3.4
9:58:21 AM	40.85	100359.03	-9.83	39.96	100195.83	-9.91	28.58	100160.55	-7.73	43.12	100094.09	-9.96	0.04	253	264	0.02	252	261	32.45	3.79	3.4
9:58:22 AM	40.9	100350.17	-9.83	39.92	100193.77	-9.9	28.58	100153.78	-7.74	43.13	100086.09	-9.96	0.02	253	261	0.03	253	262	33.26	3.79	3.4
9:58:23 AM	40.85	100350.98	-9.84	39.91	100198.33	-9.91	28.58	100164.92	-7.74	43.15	100087.36	-9.96	0.02	251	261	0.02	253	260	33.99	3.8	3.4
9:58:24 AM	40.89	100363.09	-9.84	39.9	100202.45	-9.91	28.59	100152.12	-7.74	43.17	100088.61	-9.97	0.02	251	261	0.03	254	262	34.67	3.79	3.4
9:58:25 AM	40.92	100350.08	-9.84	40	100208.65	-9.92	28.59	100147.92	-7.75	43.19	100090.7	-9.97	0.03	252	263	0.02	253	260	35.3	3.79	3.4
9:58:26 AM	40.9	100363.48	-9.84	39.96	100196.15	-9.92	28.59	100148.41	-7.76	43.2	100094.94	-9.97	0.03	252	262	0.03	252	262	35.93	3.79	3.4
9:58:27 AM	41.01	100359.27	-9.85	40	100194.9	-9.92	28.59	100152.62	-7.76	43.23	100099.56	-9.98	0.03	253	263	0.03	254	262	36.51	3.8	3.4
9:58:28 AM	40.87	100355	-9.85	40.02	100196.09	-9.93	28.6	100161.59	-7.76	43.24	100104.19	-9.98	0.02	251	261	0.02	252	261	37.04	3.79	3.4
9:58:29 AM	40.85	100358.33	-9.86	40.04	100194.84	-9.93	28.6	100159.56	-7.77	43.26	100103.78	-9.99	0.02	250	261	0.02	253	260	37.55	3.79	3.4
9:58:30 AM	40.97	100352.42	-9.86	40.08	100207.28	-9.93	28.6	100160.05	-7.77	43.27	100101.67	-9.99	0.03	251	262	0.02	252	261	38.04	3.79	3.4
9:58:31 AM	40.93	100347.3	-9.87	40.11	100208.47	-9.94	28.6	100158.77	-7.77	43.28	100097.03	-10	0.02	252	261	0.03	252	263	38.5	3.79	3.4
9:58:32 AM	41	100355.23	-9.88	40.18	100208.47	-9.94	28.6	100162.61	-7.77	43.3	100102.51	-10	0.02	252	261	0.03	253	262	38.97	3.79	3.4
9:58:33 AM	41.03	100347.69	-9.88	40.11	100205.1	-9.95	28.6	100155.4	-7.78	43.31	100097.45	-10	0.02	250	261	0.02	253	261	39.39	3.79	3.4
9:58:34 AM	41.06	100346.38	-9.89	40.08	100198.83	-9.95	28.6	100160.52	-7.78	43.32	100097.89	-10.01	0.04	252	264	0.02	252	261	39.82	3.79	3.4
9:58:35 AM	41.08	100356.38	-9.89	40.16	100199.64	-9.96	28.6	100151.56	-7.78	43.32	100093.26	-10.01	0.03	252	262	0.02	253	260	40.19	3.79	3.4
9:58:36 AM	41.11	100342.55	-9.89	40.19	100196.64	-9.97	28.61	100143.94	-7.78	43.29	100099.55	-10.02	0.03	252	263	0.02	252	260	40.59	3.79	3.4
9:58:37 AM	41.14	100352.95	-9.9	40.24	100203.27	-9.97	28.61	100146.5	-7.78	43.35	100083.15	-10.03	0.03	252	262	0.02	252	260	40.96	3.78	3.4
9:58:38 AM	41.12	100362.58	-9.9	40.11	100209.08	-9.97	28.61	100151.27	-7.79	43.36	100088.2	-10.02	0.03	253	262	0.02	253	261	41.31	3.79	3.4
9:58:39 AM	41.05	100358.75	-9.91	40.33	100209.03	-9.98	28.61	100147.84	-7.79	43.37	100085.7	-10.03	0.02	252	260	0.02	251	261	41.64	3.79	3.4
9:58:40 AM	41.12	100351.2	-9.91	40.22	100204.84	-9.98	28.61	100161.5	-7.79	43.38	100092.84	-10.03	0.03	253	261	0.02	254	261	41.96	3.79	3.4
9:58:41 AM	41.19	100364.16	-9.91	40.2	100193.16	-9.99	28.61	100161.98	-7.8	43.39	100084.84	-10.03	0.03	253	262	0.02	253	261	42.31	3.79	3.4
9:58:42 AM	41.16	100357.44	-9.92	40.21	100194.38	-9.99	28.61	100165.34	-7.79	43.4	100089.47	-10.04	0.03	253	262	0.02	252	261	42.61	3.79	3.4
9:58:43 AM	41.2	100346.94	-9.92	40.21	100189.77	-10	28.62	100165.41	-7.8	43.42	100091.56	-10.04	0.02	250	261	0.03	252	262	42.89	3.79	3.4
9:58:44 AM	41.2	100356.85	-9.93	40.26	100194.7	-10.01	28.61	100167.96	-7.8	43.42	100095.38	-10.05	0.03	251	262	0.03	253	263	43.18	3.79	3.4

Figure 37 - Sample of data extracted to Excel

#### 4.1.1 MATLAB code

To obtain the behaviour of ‘heated temperature’ a MATLAB code is written. It can be seen that the ‘heated temperature’ increases and stabilizes after a short period of time referred to as ‘heated temperature’. The code presented below.

```

clear
close all

data = [-0.62
-0.13
0.09
0.22
0.34
0.45
0.49
0.55
0.62
0.67|
4.18
4.19
4.17
];

Ta=zeros(size(data,1)/60,1);
Th=zeros(size(data,1)/60,1);

Ta(1) = data(1,1);
Th(size(data,1)/60) = data(size(data,1),1);

for i=60:60:size(data,1)-1
    Th(i/60,1) = data(i,1);
    Ta(i/60+1,1) = data(i+1,1);
end

delta_T = Th-Ta;

plot (delta_T);
axis equal

plot (data)

```

Figure 38 - Data extraction MATLAB code

The heated temperature values were obtained and plotted and further implemented in plotting the graphs for velocity and irradiance and other analysis using Excel.

#### 4.1.2 'Heated temperature'

Figure 37 shows an example of 'heated temperature' behaviour. The graph is plotted using a MATLAB code for 2883 data points gathered in a field test.



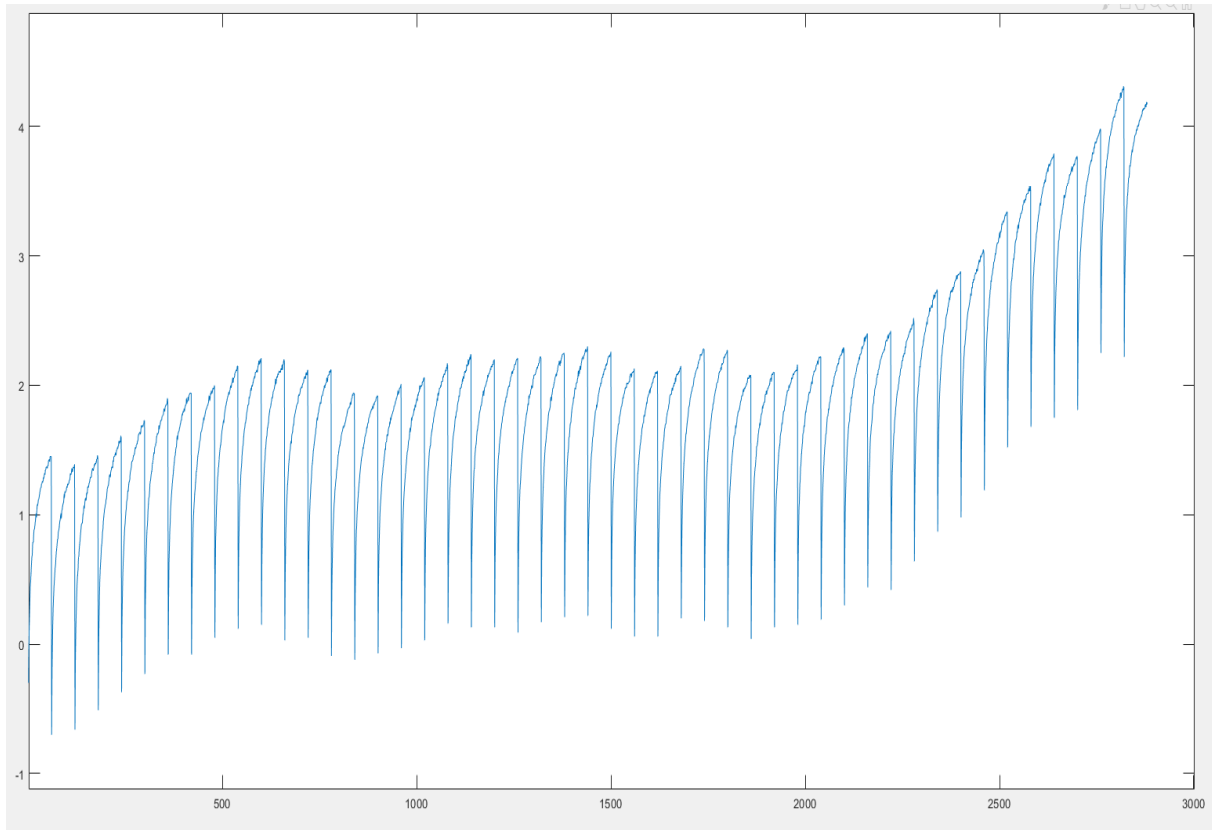

*Figure 39 - an example of heated temperature behavior in a field test*

The horizontal axis shows the number of data and the vertical axis is the temperature values it can be seen that the temperature rises from ambient temperature and stabilizes after a short period referred to as 'heated temperature'. The heater functions for sixty seconds and it makes the temperature rise to 'heated temperature' then the heater stops for 540 seconds and the temperature drops to almost ambient temperature. As it can be seen ambient temperature changes in each cycle to a small extent this, can be due to a local temperature change where the device is working or minor errors of the sensors on the device. The increase in sensor's active time and passive time improves stabilization but it has a negative effect on battery life and there is a risk of sensor failure because of overheating. Also, 'heated temperature' varies which is due to change and the cumulative effect of wind velocity, humidity, irradiance and ambient temperature. By looking at the graph, it can be mentioned that the 'heated temperature' alters with a pattern similar to ambient temperature, therefore, 'heated temperature' is very sensitive to ambient temperature beside other parameters.

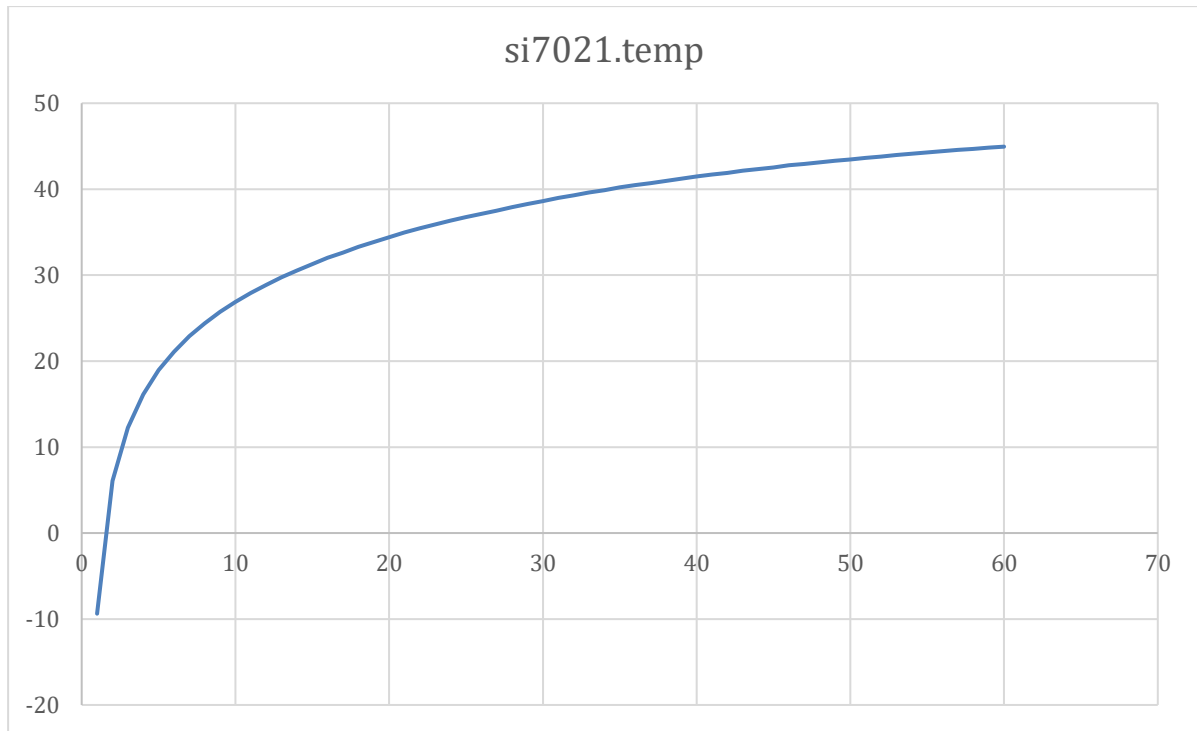

Figure 40 - Example of 'heated temperature' behavior in a lab test

In the lab tests the parameters were controlled individually to analyze the effect of each parameter on 'heated temperature' figure 39 refers to a wind velocity of 1 m/s and -20 degrees Celsius with no irradiance and default humidity. Some examples of 'heated temperature' graphs are attached in appendix IV.

## 4.2 The influence of 'heated temperature' associated parameters

In this section the 'heated temperature' associated parameters influence on 'cold' sensation is discussed based on the analysis and data collected in lab, field and meteorological data.

### 4.2.1 Velocity

In the lab experiments, wind velocity was controlled and monitored with a voltage regulator and anemometer therefore for each ambient temperature the wind velocity on each sensor can be calculated implementing the data gathered in the field and in the lab with the same strategy in section 3.1.2 and the linear equation  $ax+b=y$  with a reliable amount of error. Therefore, wind velocity value which is of importance in finding the cumulative influence of 'heated temperature' associated parameters is known.

In the lab tests, the wind velocity chose to be blown on the device was 0, 1, 2, 3 and 4 m/s in the field tests meteorological data is comparable with velocities estimated from pressure difference values.

Figures 41 to 44 show the heated temperature relation with velocity in ambient temperatures 0 to -45 in lab tests with the halogen light bulb voltage of 0, 6, 9 and 12 volts. For plotting the graphs, the 'heated temperature' for each velocity in each ambient temperature and irradiance has been used to consider the velocity influence on 'heated temperature' values.

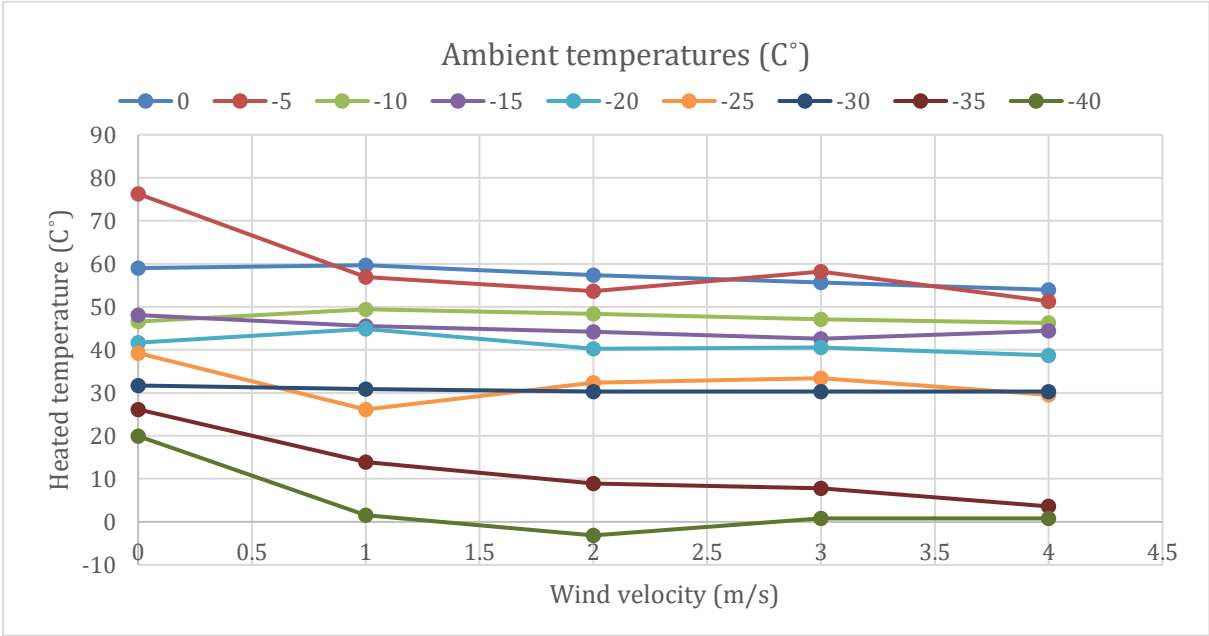

Figure 41 - Th, Ta and Velocity (0 v)

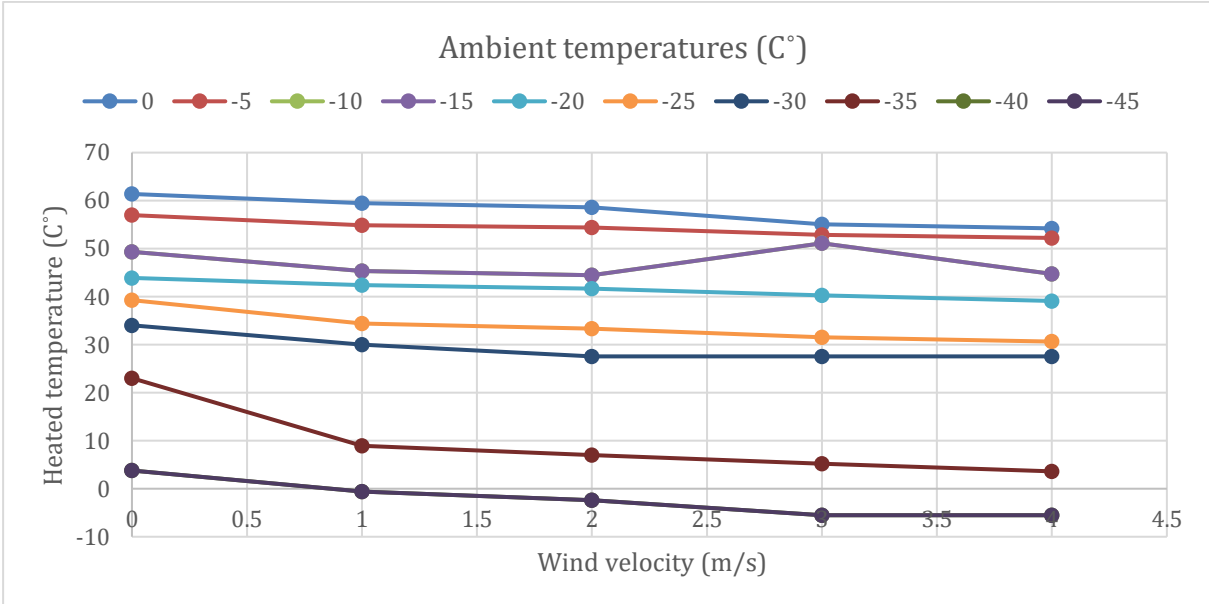

Figure 42 - Th, Ta and velocity (6 v)

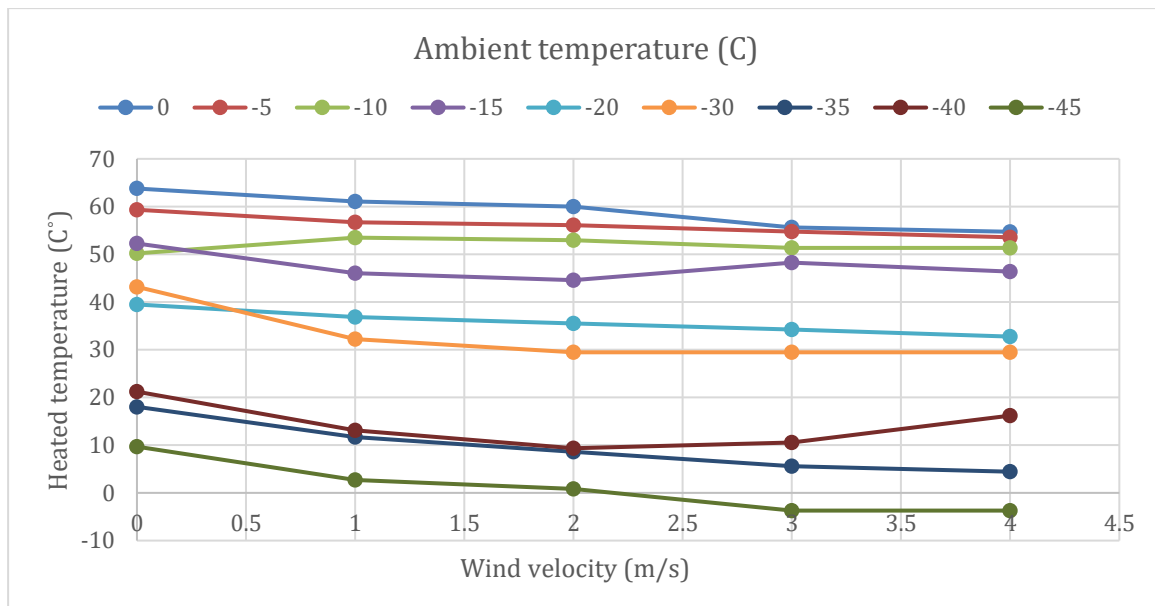

Figure 43 -  $T_h$ ,  $T_a$  and wind velocity (9 v)

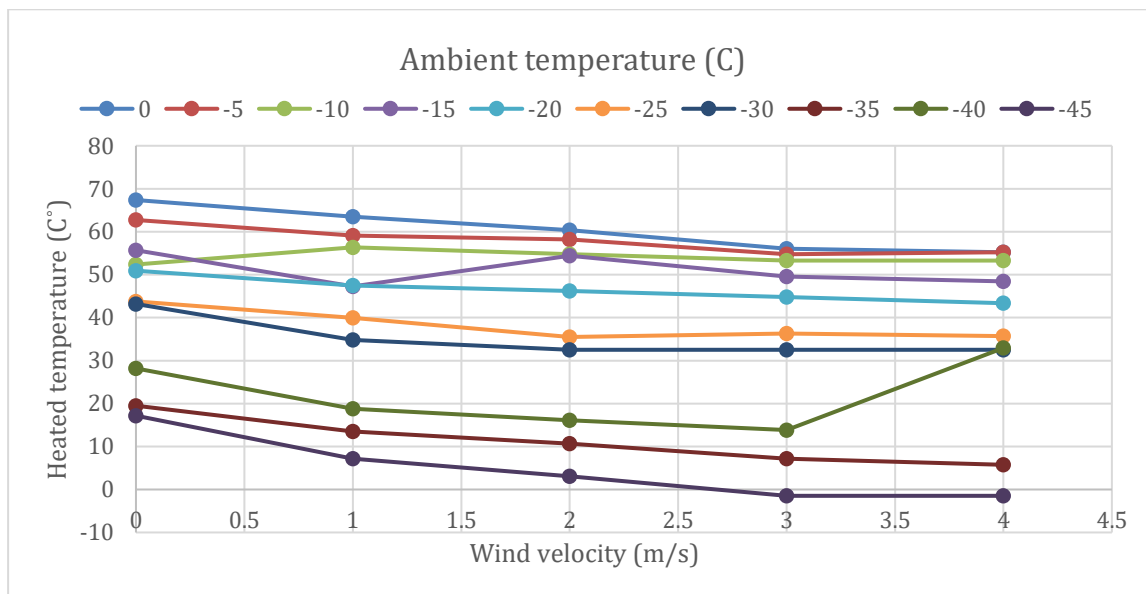

Figure 44 -  $T_h$ ,  $T_a$  and wind velocity (12 v)

The graphs above show the relation between wind velocity and 'heated temperature' in different ambient temperatures and irradiance strengths. It can be seen that there is a downward trend for each ambient temperature which means increasing the wind velocity decreases the 'heated temperature'. Also, lower ambient temperature leads to a reduction in 'heated temperature values'. Comparing the graphs in different irradiance strengths shows that the higher values of halogen light voltage have a higher 'heated temperature'. It can be said that the device is quite sensitive to changes in velocity and irradiance. The same process and graphs can be plotted for the data gathered in the field.

### 4.2.2 Pressure

In the section 3.1.2 had been discussed that pressure difference between the exposed sensor to wind and reference pressure can give an estimation of wind velocity. To see the effects of wind velocity on the pressure the device was tested by blowing the wind directly to each sensor. The result showed that the sensors are sensitive to winds blowing directly to them in way that there is a pressure reduction on the exposed sensor, therefore the wind velocity and pressure difference relation is reliable with e certain amount of error. The analysis which ensured the pressure sensor sensitivity in attached in appendix V.

### 4.2.3 Irradiance

In the lab experiments, the irradiance changed using a halogen light bulb and a voltage regulator. The halogen light bulb was installed straight to the top of the carton box. The angle of light influences the irradiance. for the experiments the angle was about 45 degrees, also the irradiance sensor has 45 degrees from the horizontal and vertical direction. The voltages changed from 0 to 6, 9 and 12 volts each voltage gave a specific value for infrared, ultraviolet and visible light in  $W/M^2$ . The table below is each irradiance voltage strength data based on the data gathered and averaged in different conditions by the device in the lab experiments.

Voltages (V)	0	6	9	12
Infrared light ( $W/M^2$ )	252.4	601.86	1378.95	2347.73
Ultraviolet light ( $W/M^2$ )	0.0283	0.056	0.157	0.308
Visible light ( $W/M^2$ )	261.34	267.53	285.94	314.1

*Table 7 - Irradiance and voltages values*

To see the influence of irradiance on ‘heated temperature’ the graphs below are plotted implementing the data gathered in the lab tests. In the experiments the device was tested in ambient temperatures from 0 to -45 with 5 degrees interval and the wind speed of the fans were varied to 0, 1, 2, 3 and 4 m/s. Figures 45 to 49 shows how ‘heated temperature’ changes with irradiance in different ambient temperatures and different wind velocities.

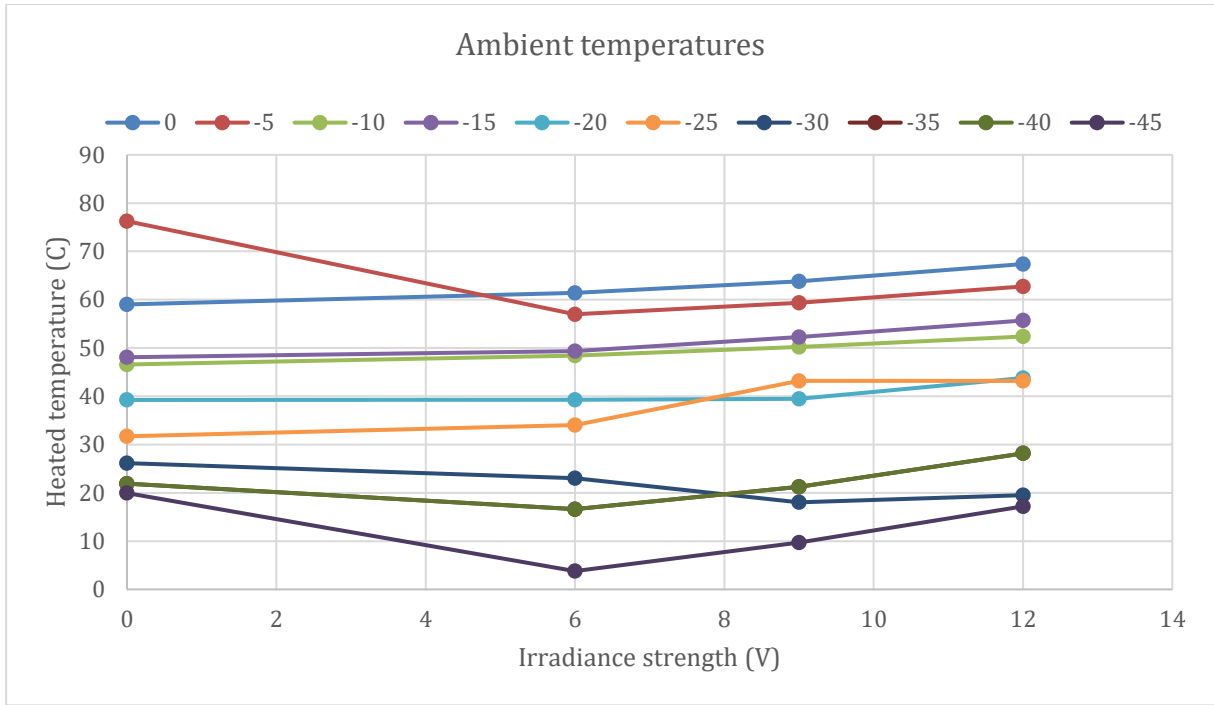

Figure 45 -  $T_h$ ,  $T_a$  and Irradiance ( $V=0$ )

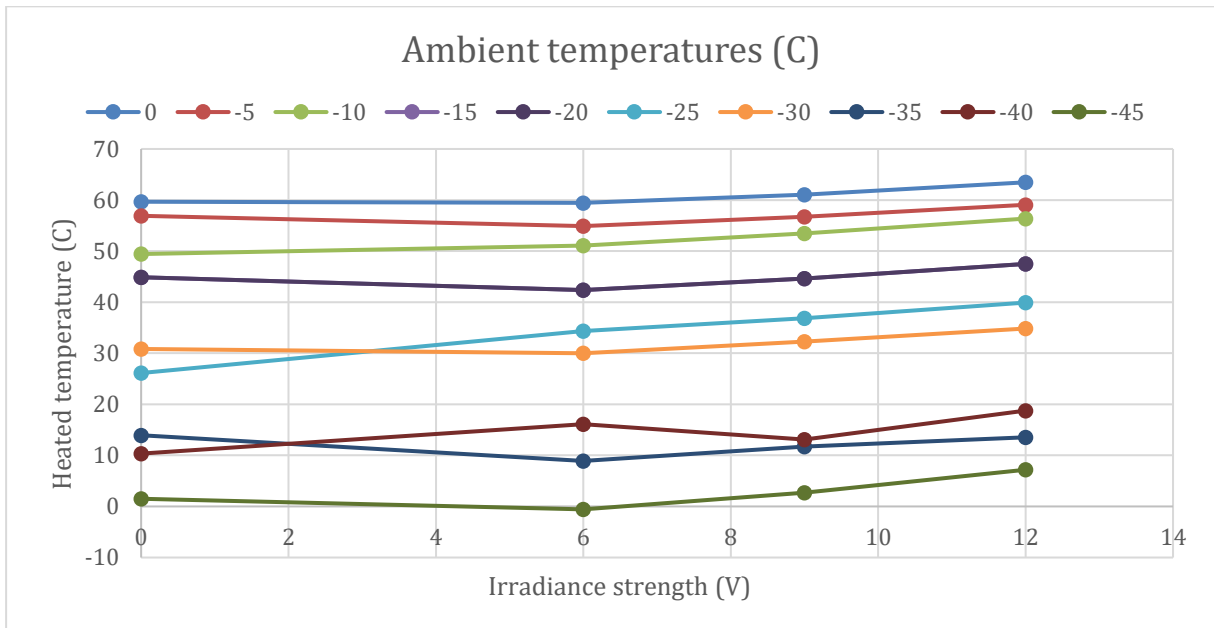

Figure 46 -  $T_h$ ,  $T_a$  and Irradiance ( $V=1$ )

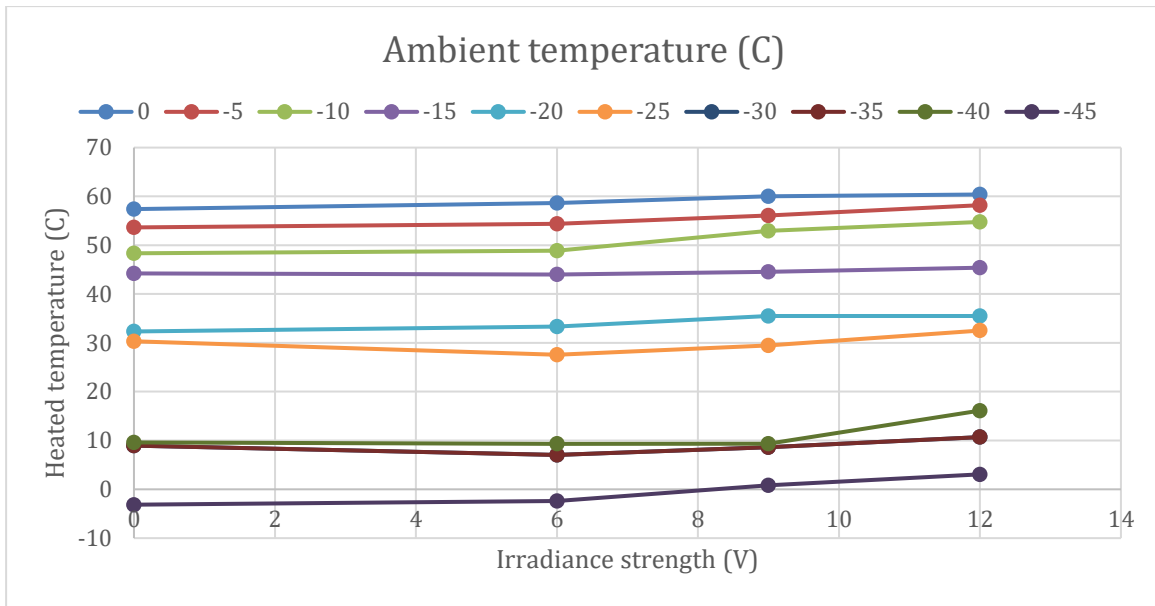

Figure 47 -  $T_h$ ,  $T_a$  and Irradiance ( $V=2$ )

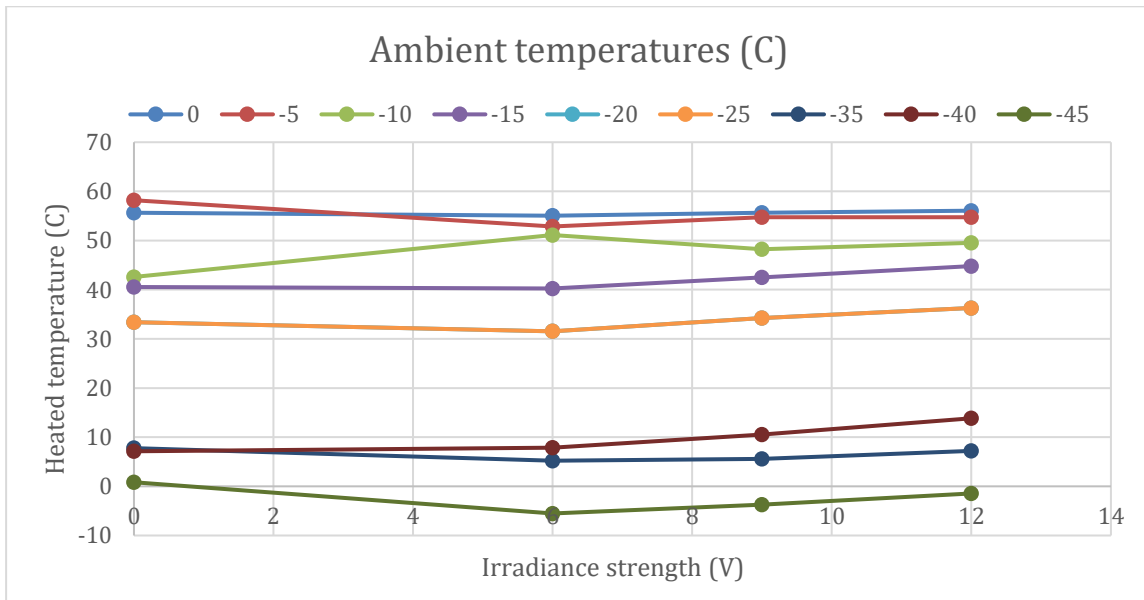

Figure 48 -  $T_h$ ,  $T_a$  and Irradiance ( $V=3$ )

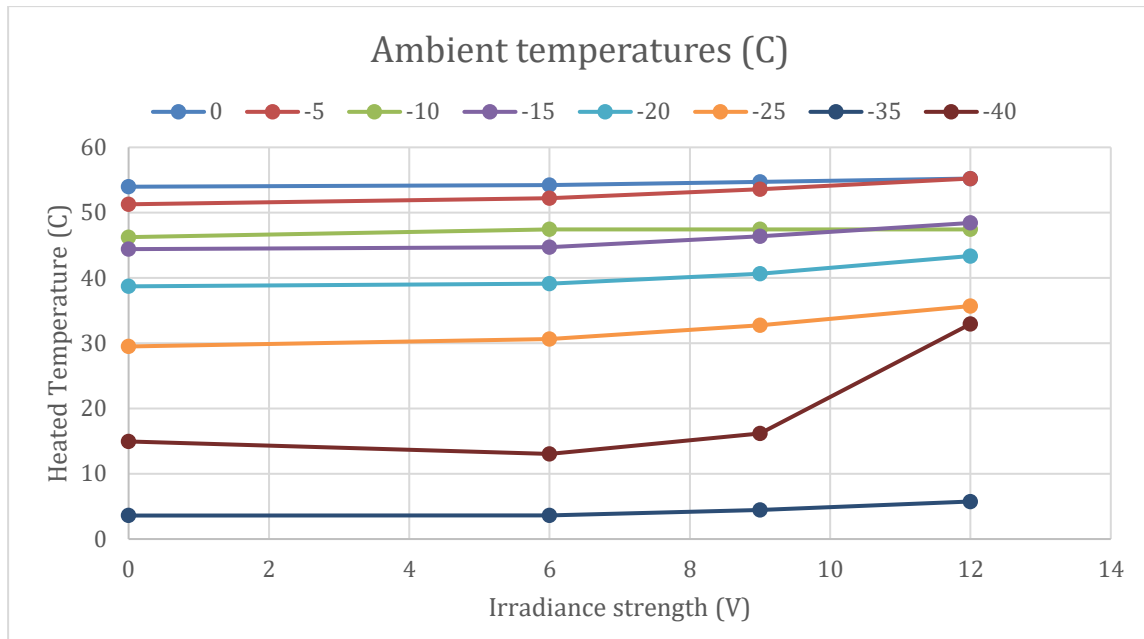

Figure 49 -  $T_h$ ,  $T_a$  and Irradiance ( $V=4$ )

By looking at the graphs it can be seen that there is a general upward trend in each ambient temperature which means increasing the irradiance gives higher values of ‘heated temperature’ also it can be seen that in higher ambient temperature the ‘heated temperature’ is bigger. By comparing the figures 45 to 49 it can be concluded that the higher wind velocities give a lower ‘heated temperature values’.

#### 4.2.4 Humidity

The humidity in the field tests was not controlled and they are collected by the device. In the lab tests, the humidity changed using two cups filled with water in -45 degrees Celsius and wind speeds varied from 0 to 1, 2 and 3 m/s. The humidity tests can be varied to several different forms by changing the humidity in the cold box. As an example, below is a comparison of meteorological data and field data in 02.04.2019 from 00:00 to 08:00. Also, a comparison between two different humidity changes in lab test is made to see the humidity effect on ‘heated temperature’.



Detailed forecast April 2, 2019

Time	Weather	Temp.	Precipitation	Wind	Pressure	Humidity	Dew point	Cloud cover				
								Total	Fog	Low clouds	Middle clouds	High clouds
00:00		-2°	0 – 0.1 mm	Gentle breeze, 4 m/s from south	1008 hPa	85 %	-5°	100 %	1 %	99 %	92 %	71 %
01:00		-2°	0.2 – 0.3 mm	Gentle breeze, 4 m/s from south	1008 hPa	83 %	-5°	100 %	1 %	95 %	95 %	100 %
02:00		-1°	0.2 – 0.3 mm	Gentle breeze, 4 m/s from south	1008 hPa	87 %	-3°	100 %	1 %	89 %	96 %	100 %
03:00		-1°	0.1 – 0.4 mm	Gentle breeze, 4 m/s from south-southeast	1008 hPa	87 %	-3°	100 %	1 %	99 %	94 %	100 %
04:00		0°	0.1 – 0.2 mm	Gentle breeze, 5 m/s from south	1007 hPa	85 %	-2°	100 %	1 %	94 %	100 %	100 %
05:00		1°	0.6 – 1.2 mm	Moderate breeze, 7 m/s from south	1007 hPa	86 %	-1°	100 %	1 %	100 %	100 %	100 %
06:00		1°	0.7 – 1.3 mm	Moderate breeze, 6 m/s from south	1006 hPa	89 %	0°	100 %	0 %	99 %	100 %	100 %
07:00		2°	0.5 – 1.1 mm	Fresh breeze, 8 m/s from south	1006 hPa	91 %	0°	100 %	1 %	97 %	100 %	100 %
08:00		2°	0.6 – 1.3 mm	Moderate breeze, 7 m/s from south	1006 hPa	91 %	1°	100 %	1 %	97 %	100 %	100 %

Figure 50 - Meteorological data for 2.4.19

Date	Average Humidity sensor 1	Average Humidity sensor 3	Average Temperature in sensors 1 & 3 (c°)
02.04.2019	88.25	85.65	0.74

Table 8 - Field test parameters for 2.4.19

Comparing the results from field test and meteorological data there is minor difference thus it can be said that field tests are reliable and accurate in terms of ambient temperature and humidity values.

As an example, two different humidity in -45 degrees Celsius is compared in figure 51.

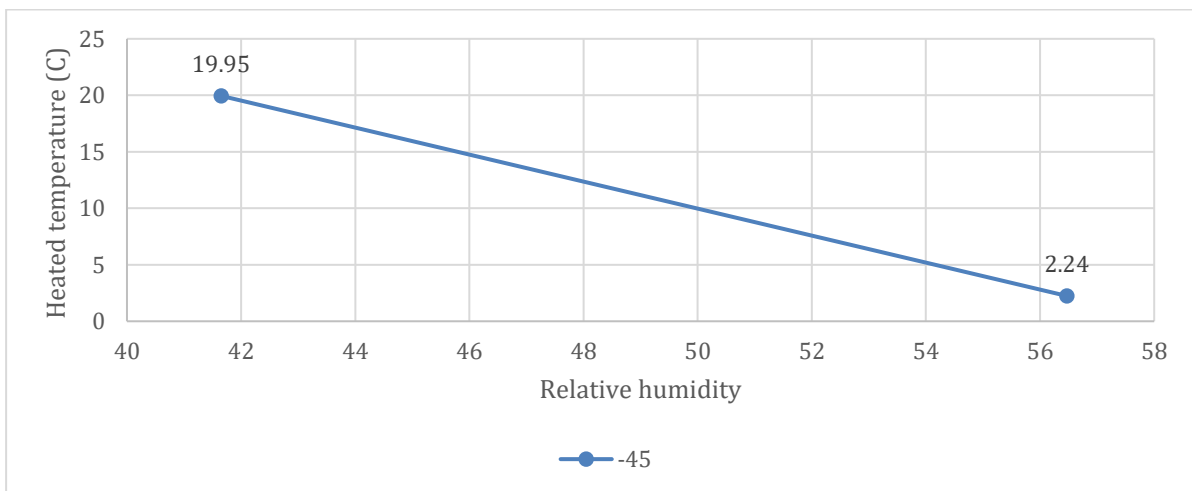

Figure 51 - Humidity and heated temperature graph

The graph above refers to -45 degree ambient temperature and two different humidity (1) is the default and (2) is the humidity with two cups of water inside the carton box. The two cups of water increased the humidity from 41.65 to 56.47. It can be seen that increased humidity led to a lower 'heated temperature' in this case, however, to make a more accurate conclusion the humidity tests should be conducted with more variability.

#### **4.2.5 Connection between parameters**

Based on the analysis it can be concluded that 'heated temperature' which can be a measure of 'cold' sensation is influenced by ambient temperature, wind velocity, humidity and irradiance.

Ambient temperature, humidity and irradiance values can be measured directly and quite accurately based on the comparison of the data collected and meteorological data. The challenging part for estimating the 'heated temperature' values is wind velocity. Wind velocity can be measured indirectly using pressure values. The results showed that the velocity values obtained from pressure difference values are reliable and close to the values controlled and measured by regulator and anemometer, thus finding a relation between 'heated temperature' and its associated parameters is possible. There can be an equation for measuring 'heated temperature'. The 'heated temperature' can be introduced as a function of ambient temperature, wind velocity, humidity and irradiance.

$$Th = f(Ta, V, H, I) \quad (3)$$

The equation above can be introduced implementing numerical and statistical methods. However, the 'heated temperature' associated parameters are also connected, and they affect each other. The results have shown their individual influence on 'heated temperature' values in lab tests by controlling each parameter.

## 5 Conclusion

In this part of the thesis conclusions which can be drawn from data analysis and results are presented.

This thesis is focused on finding the relation between ‘heated temperature’ and its associated parameters: ambient temperature, wind velocity, humidity and irradiance. To see this relation the WINDTECH device was tested both in the field and in the lab with various conditions and controlling each parameter to consider the influence of each parameter towards ‘heated temperature’. Based on the results it was clear that each parameter has an Influence on the ‘heated temperature’ values.

Regarding velocity, the graphs in section 4.2.1 showed that the higher wind velocity decreases the ‘heated temperature’ which means heat loss increases in higher wind velocities. Also ‘heated temperature’ values were lower in low ambient temperatures that mean in lower temperatures the heat loss is higher.

In irradiance experiments, results showed that higher irradiance values increase the ‘heated temperature’ values that mean, the heat loss is less when there is an exposure to light, this similar to experiencing less cold in sun rather than staying in shades. Also, for irradiance experiments the ambient temperature showed a similar pattern as in velocity experiments where higher ambient temperature gave a higher ‘heated temperature’ value.

Humidity values can be relatively controlled in lab tests however, field tests showed that the device can collect humidity values accurately. In lab tests the results indicated that higher humidity decreases the ‘heated temperature’.

The challenging part of the ‘heated temperature’ value estimation is wind velocity since there is no direct method to measure the wind velocity, however, results showed that wind velocities can be measured indirectly by measuring the pressure and having a reference pressure values. The difference between these two values can give an estimation of wind velocity which the device or humans are exposed to.

Finally, it can be concluded that ‘heated temperature’ is a function of parameters: ambient temperature, wind velocity, humidity and irradiance and a relation between all these parameters and ‘heated temperature’ can be established implementing numerical or machine learning algorithms.

Estimating the ‘heated temperature’ values in any weather condition can help measuring the heat loss and it can be used to introduce risk management plans for humans or any technologies working in harsh cold climate.

## 6 Suggestion for further work

There can be various suggestions on this thesis to further develop the research.

- The device can be prototyped again with a more robust shell and higher water and humidity resistance
- The battery life of the device can improve
- The device can be designed in a smaller package
- The field test can be conducted in much more various conditions
- Field tests can be done in controlled conditions such as making a shelter for the device from different sides to consider the irradiance and wind velocity on different sensors
- Lab experiments can be carried out in many more conditions of wind velocity, irradiance, ambient temperature and humidity
- The device can be tested by people wearing it in different age, sex, weight, physical fitness in several weather conditions and later interviewed about how they felt about the cold weather condition to consider the parameters affecting people on real situations
- Much more detailed analysis of the data considering each parameter and their potential influence towards each other and towards heated temperature can be done
- The data can be developed to machine learning algorithms to quantify the effect of each parameter towards 'cold' sensation

## 7 References

- ABS, G. *Low Temperature Operations*. Retrieved from Houston: <https://www.eagle.org/eagleExternalPortalWEB/ShowProperty/BEA%20Repository/References/Booklets/2009/LowTempOps>
- Ahmad, T., Rashid, T., Khawaja, H., & Moatamedi, M. (2016). Study of Wind Chill Factor using Infrared Imaging. *2016*, *10*(3). Retrieved from <http://journal.multiphysics.org/index.php/IJM/article/view/123>. doi:10.21152/1750-9548.10.3.325
- Auerbach, P. S. (2007). Hypothermia Frostbite and Other Cold Injuries, Second edition. *Wilderness & Environmental Medicine*, *18*(2), 155. Retrieved from [https://doi.org/10.1580/1080-6032\(2007\)18\[155:HFAOCI\]2.0.CO;2](https://doi.org/10.1580/1080-6032(2007)18[155:HFAOCI]2.0.CO;2). doi:10.1580/1080-6032(2007)18[155:HFAOCI]2.0.CO;2
- Average Weather in Tromsø. Retrieved from <https://weatherspark.com/y/84211/Average-Weather-in-Troms%C3%B8-Norway-Year-Round>
- Barabadi, A., Garmabaki, A. H. S., & Zaki, R. (2016). Designing for performability: An icing risk index for Arctic offshore. *Cold Regions Science and Technology*, *124*, 77-86. Retrieved from <https://www.scopus.com/inward/record.uri?eid=2-s2.0-84956975220&doi=10.1016%2fj.coldregions.2015.12.013&partnerID=40&md5=a970679e8de74b1ed4f54bd69f6ee940>. doi:10.1016/j.coldregions.2015.12.013
- Bluestein, M. (1998). An evaluation of the wind chill factor: Its development and applicability. *Journal of Biomechanical Engineering*, *120*(2), 255-258. Retrieved from <https://www.scopus.com/inward/record.uri?eid=2-s2.0-0032054198&doi=10.1115%2f1.2798309&partnerID=40&md5=fe324e0c899163c76c43abda098ec94d>. doi:10.1115/1.2798309
- Bosch. (2014). BME280 Combined humidity and pressure sensor. In (1 ed.).
- Brauner, N., & Shacham, M. (1995). Meaningful wind chill indicators derived from heat transfer principles. *International Journal of Biometeorology*, *39*(1), 46-52. Retrieved from <https://www.scopus.com/inward/record.uri?eid=2-s2.0-0029353828&doi=10.1007%2fBF01320893&partnerID=40&md5=ca368ea986603b59f2efca10e8bedbec>. doi:10.1007/BF01320893
- Campbell, T., Williams, C., Ivanova, O., & Garret, B. (2011). *Could 3D printing change the world?* Retrieved from <https://www.atlanticcouncil.org/publications/reports/could-3d-printing-change-the-world>
- Castellani, J. W., & Young, A. J. (2016). Human physiological responses to cold exposure: Acute responses and acclimatization to prolonged exposure. *Autonomic Neuroscience: Basic and Clinical*, *196*, 63-74. Retrieved from <https://www.scopus.com/inward/record.uri?eid=2-s2.0-84959115130&doi=10.1016%2fj.autneu.2016.02.009&partnerID=40&md5=1f4857dac8b3ccde21eeaf1b7f4fb334>. doi:10.1016/j.autneu.2016.02.009
- Castellani, J. W., Young, A. J., Ducharme, M. B., Giesbrecht, G. G., Glickman, E., & Sallis, R. E. (2006). Prevention of cold injuries during exercise. *Medicine and Science in Sports and Exercise*, *38*(11), 2012-2029. Retrieved from <https://www.scopus.com/inward/record.uri?eid=2-s2.0-33750729592&doi=10.1249%2f01.mss.0000241641.75101.64&partnerID=40&md5=1963c7e75f11f706c8b39ffb7f5fa489>. doi:10.1249/01.mss.0000241641.75101.64
- Chandler, N. What Is Relative Humidity and How Does it Affect How I Feel Outside? Retrieved from <https://science.howstuffworks.com/nature/climate-weather/atmospheric/question651.htm>
- Crockett, C. (2017). What is the electromagnetic spectrum? Retrieved from <https://earthsky.org/space/what-is-the-electromagnetic-spectrum>
- The Electromagnetic Spectrum. (2013). Retrieved from <https://imagine.gsfc.nasa.gov/science/toolbox/emspectrum2.html>
- Factors Affecting Arctic Weather and Climate. Retrieved from [https://nsidc.org/cryosphere/arctic-meteorology/factors\\_affecting\\_climate\\_weather.html](https://nsidc.org/cryosphere/arctic-meteorology/factors_affecting_climate_weather.html)
- Gabbert, B. (2013). Holes in the Yarnell Hill Fire swiss cheese. Retrieved from <https://wildfiretoday.com/2013/12/15/holes-in-the-yarnell-hill-fire-swiss-cheese/>

- Gordon, R. P. E. (1998). The contribution of human factors to accidents in the offshore oil industry. *Reliability Engineering & System Safety*, 61(1), 95-108. Retrieved from <http://www.sciencedirect.com/science/article/pii/S0951832098800033>. doi:[https://doi.org/10.1016/S0951-8320\(98\)80003-3](https://doi.org/10.1016/S0951-8320(98)80003-3)
- Heckert, P. A. (2011). Why Does Damp Cool Weather Make It Feel Colder? Retrieved from <https://www.decodedscience.org/why-does-damp-cool-weather-make-it-feel-colder/6736>
- Irzmańska, E., Wójcik, P., & Adamus - Włodarczyk, A. (2018). Manual work in cold environments and its impact on selection of materials for protective gloves based on workplace observations. *Applied Ergonomics*, 68, 186-196. Retrieved from <https://www.scopus.com/inward/record.uri?eid=2-s2.0-85035781001&doi=10.1016%2fj.apergo.2017.11.007&partnerID=40&md5=4b1b134e137b2d80ba79826093825f43>. doi:10.1016/j.apergo.2017.11.007
- John, B., Senthilkumar, P., & Sadasivan, S. (2019). Applied and Theoretical Aspects of Conjugate Heat Transfer Analysis: A Review. *Archives of Computational Methods in Engineering*, 26(2), 475-489. Retrieved from <https://www.scopus.com/inward/record.uri?eid=2-s2.0-85041123914&doi=10.1007%2fs11831-018-9252-9&partnerID=40&md5=77b6374a97de00afc326e57edca00f7b>. doi:10.1007/s11831-018-9252-9
- Jones, K. F., & Andreas, E. L. (2012). Sea spray concentrations and the icing of fixed offshore structures. *Quarterly Journal of the Royal Meteorological Society*(138), 131-144.
- Kaspersen, J. (2018). *Laboratory testing of the WindTech device*. (Master's), UiT, Tromsø.
- Keimig, F. T., & Bradley, R. S. (2002). Recent changes in wind chill temperatures at high latitudes in North America. *Geophysical Research Letters*, 29(8), 4-1. Retrieved from <https://www.scopus.com/inward/record.uri?eid=2-s2.0-0037092241&partnerID=40&md5=bf67773aa7bb5127600f2e72124d2af6>.
- Kirmayer, A. (2017). How Are Winds Formed? Retrieved from <https://sciencing.com/winds-formed-5145233.html>
- LABS, S. (2014). PROXIMITY/UV/AMBIENT LIGHT SENSOR IC WITH I2C INTERFACE. In.
- LABS, S. (2016). I2C HUMIDITY AND TEMPERATURE SENSOR. In.
- Landsberg, J., & Sands, P. (2011). Physiological Ecology of Forest Production. *Terrestrial Ecology*. Retrieved from <https://www.sciencedirect.com/topics/earth-and-planetary-sciences/irradiance>.
- Leon, G. R., Sandal, G. M., & Larsen, E. (2011). Human performance in polar environments. *Journal of Environmental Psychology*, 31(4), 353-360. Retrieved from <https://www.scopus.com/inward/record.uri?eid=2-s2.0-80053608934&doi=10.1016%2fj.jenvp.2011.08.001&partnerID=40&md5=597bf913e7e1bb7c23c04e51c47d6514>. doi:10.1016/j.jenvp.2011.08.001
- Lucas, J. (2015). What Is the First Law of Thermodynamics? Retrieved from <https://www.livescience.com/50881-first-law-thermodynamics.html>
- Luko, S. (2013). *Risk Management Principles and Guidelines* (Vol. 25).
- Mäkinen, T. M. (2007). Human cold exposure, adaptation, and performance in high latitude environments. *American Journal of Human Biology*, 19(2), 155-164. Retrieved from <https://www.scopus.com/inward/record.uri?eid=2-s2.0-33947434488&doi=10.1002%2fajhb.20627&partnerID=40&md5=d01923f4f537ed4c4be5ab1b0d7ef436>. doi:10.1002/ajhb.20627
- Medicine, I. o. (1996). *Nutritional Needs in Cold and High-Altitude Environments: Applications for Military Personnel in Field Operations*. Washington, DC: The National Academies Press.
- Osczevski, R., & Bluestein, M. (2005). The new wind chill equivalent temperature chart. *Bulletin of the American Meteorological Society*, 86(10), 1453-1458. Retrieved from <https://www.scopus.com/inward/record.uri?eid=2-s2.0-27844510544&doi=10.1175%2fBAMS-86-10-1453&partnerID=40&md5=080c22f15173c8f9fee78b4c04093d72>. doi:10.1175/BAMS-86-10-1453
- Overland, J. E. (1990). Prediction of Vessel Icing for Near-Freezing Sea Temperatures. *Weather and Forecasting*, 5(1), 62-77. Retrieved from <https://journals.ametsoc.org/doi/abs/10.1175/1520->

- [0434%281990%29005%3C0062%3APOVIFN%3E2.0.CO%3B2](#). doi:10.1175/1520-0434(1990)005<0062:Povifn>2.0.Co;2
- Pelletier, D., Ignat, L., & Ilinca, F. (1995). *An adaptive finite element method for conjugate heat transfer*. Paper presented at the 33rd Aerospace Sciences Meeting and Exhibit.
- Pibernat, R. A., Ellis-Evans, C., & Hinghofer-Szalkay, H. G. (2007). *Life in Extreme Environments*: Springer Netherlands.
- Polar lows explained. (2014, 11. July 2014). Retrieved from <https://www.barentswatch.no/en/services/polar-lows-explained/>
- The Polar Night – a time of colour. Retrieved from <https://nordnorge.com/en/?News=132>
- Powers, J. G., Klemp, J. B., Skamarock, W. C., Davis, C. A., Dudhia, J., Gill, D. O., . . . Duda, M. G. (2017). The weather research and forecasting model: Overview, system efforts, and future directions. *Bulletin of the American Meteorological Society*, 98(8), 1717-1737. Retrieved from <https://www.scopus.com/inward/record.uri?eid=2-s2.0-85027522405&doi=10.1175%2fBAMS-D-15-00308.1&partnerID=40&md5=a968106b46963d8abe837fd8548f9b4c>. doi:10.1175/BAMS-D-15-00308.1
- Rintamäki, H. (2006). Human responses to cold. *Alaska medicine*, 49(2 Suppl), 29-31. Retrieved from <https://www.scopus.com/inward/record.uri?eid=2-s2.0-38449108747&partnerID=40&md5=5b49a86f3ef2021d27a765a489c7c33f>.
- Ryerson, C. C. (2009). *Assessment of Superstructure Ice Protection as Applied to Offshore Oil Operations Safety*.
- Ryerson, C. C. (2011). Ice protection of offshore platforms. *Cold Regions Science and Technology*, 65(1), 97-110. Retrieved from <https://www.scopus.com/inward/record.uri?eid=2-s2.0-78649785822&doi=10.1016%2fj.coldregions.2010.02.006&partnerID=40&md5=801187ca8175f8aabe08670421f027ce>. doi:10.1016/j.coldregions.2010.02.006
- Shah, K., & Jain, A. (2015). An iterative, analytical method for solving conjugate heat transfer problems. *International Journal of Heat and Mass Transfer*, 90, 1232-1240. Retrieved from <https://www.scopus.com/inward/record.uri?eid=2-s2.0-84938614081&doi=10.1016%2fj.ijheatmasstransfer.2015.07.056&partnerID=40&md5=5f8c92841ed547b79859036d8792ad30>. doi:10.1016/j.ijheatmasstransfer.2015.07.056
- Steadman, R. G. (1971). Indices of windchill of clothed persons. *Journal of Applied Meteorology*, 10(4), 674-683. Retrieved from <https://www.scopus.com/inward/record.uri?eid=2-s2.0-0015108684&partnerID=40&md5=78c1cff8f382558688693cf6558e0492>.
- Swart, D. K. J. (2017). *Assessment and development of device for monitoring workers in cold environment*. (Master's), UiT, Tromsø.
- Valkonen, L., & Lausala, T. (1999). Economic geography and structure of the Russian territories of the Barents region. Retrieved from <https://www.barentsinfo.org/Contents/Nature/Natural-resources/Natural-resources-in-the-region#>
- Van Ooijen, A. M. J., Van Marken Lichtenbelt, W. D., Van Steenhoven, A. A., & Westerterp, K. R. (2004). Seasonal changes in metabolic and temperature responses to cold air in humans. *Physiology and Behavior*, 82(2-3), 545-553. Retrieved from <https://www.scopus.com/inward/record.uri?eid=2-s2.0-3242808118&doi=10.1016%2fj.physbeh.2004.05.001&partnerID=40&md5=01e23089b816d20fe047d91566a2f735>. doi:10.1016/j.physbeh.2004.05.001
- Weisberger, M., & Writer, S. (2018). Freakishly Warm Weather in the Arctic Has Climate Scientists 'Stunned'. Retrieved from <https://www.livescience.com/61864-arctic-temperatures-record-high.html>
- Wu, J., Pang, Z., Zhang, P., Yao, X., Li, H., Xu, H., & Li, C. (2016) Research on connection between wind-chill factor and human perception in extremely cold areas experiment environment. In: *Vol. 406. Lecture Notes in Electrical Engineering* (pp. 407-411).
- Yakout, M., Elbestawi, M. A., & Veldhuis, S. C. (2018) A review of metal additive manufacturing technologies. In: *Vol. 278 SSP. Solid State Phenomena* (pp. 1-14).





# APPENDIX I

## Pressure and wind velocity graphs

The figures below are graphs showing how pressure difference changes with wind velocity in different ambient temperature when wind is blowing from **top** and reference pressure sensor is **inside** of the cold box.

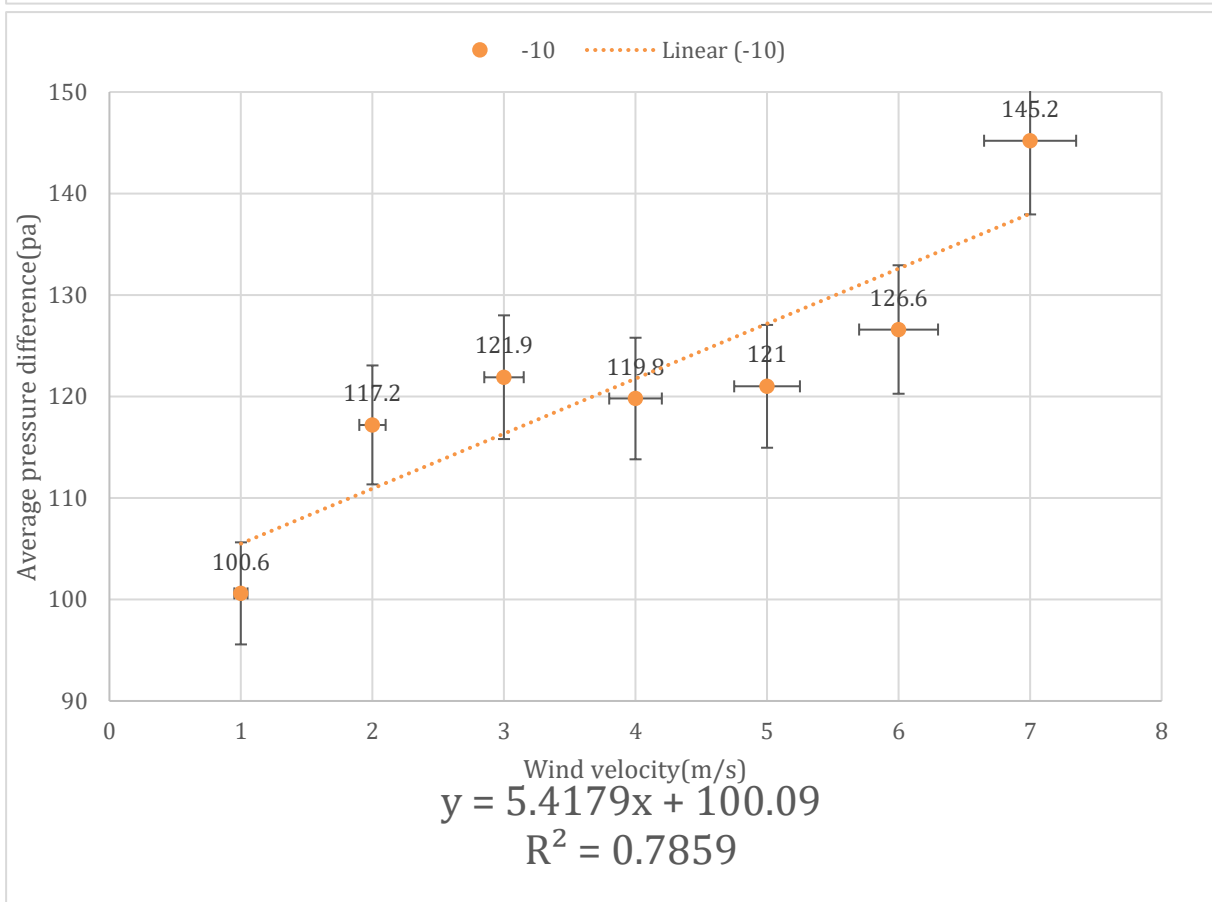
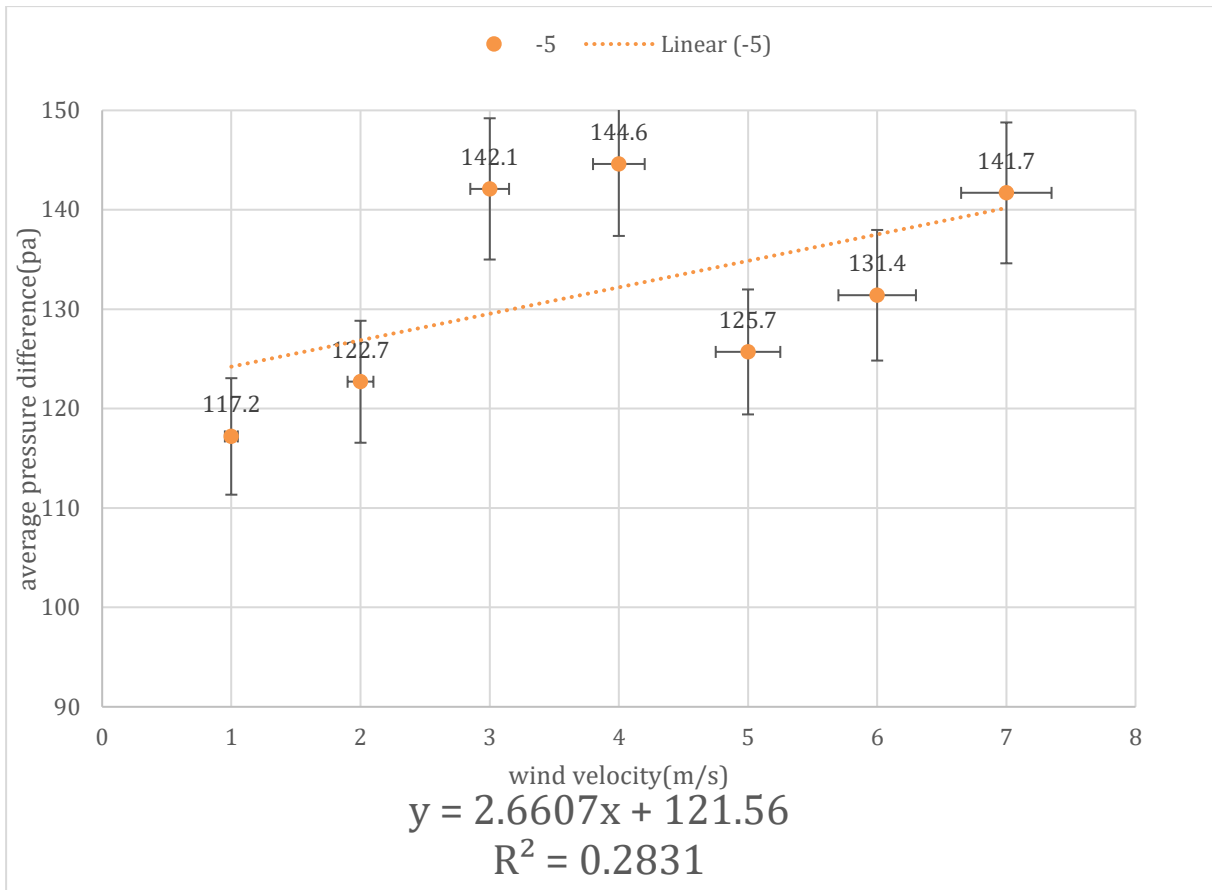

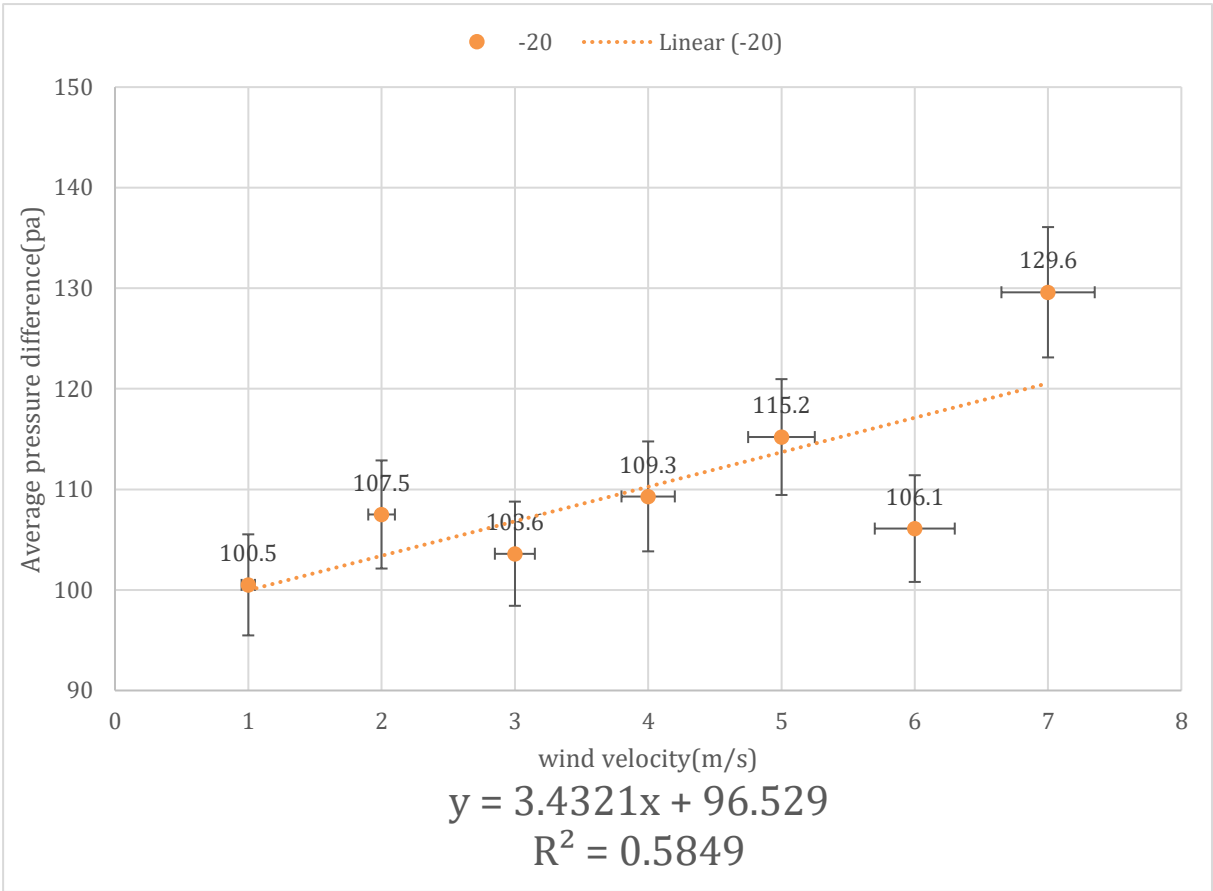
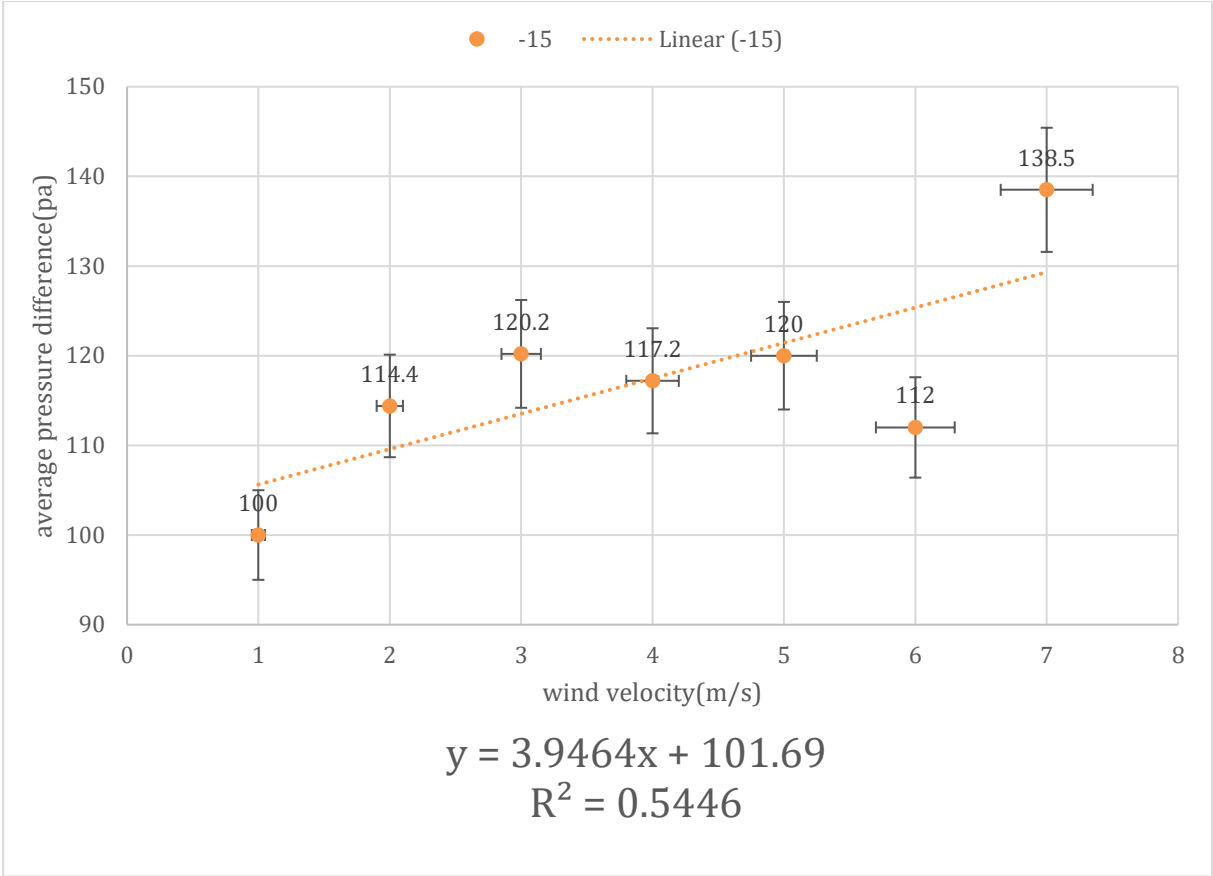

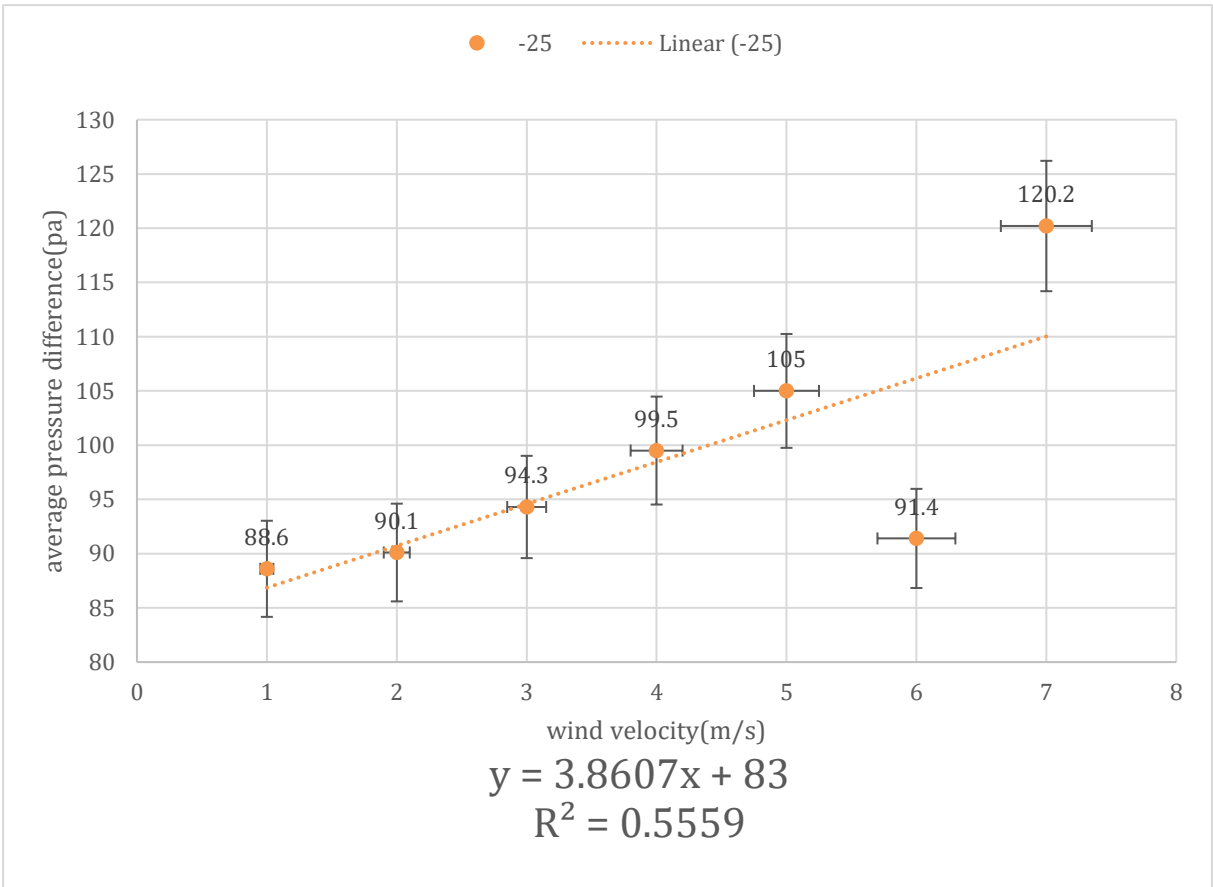
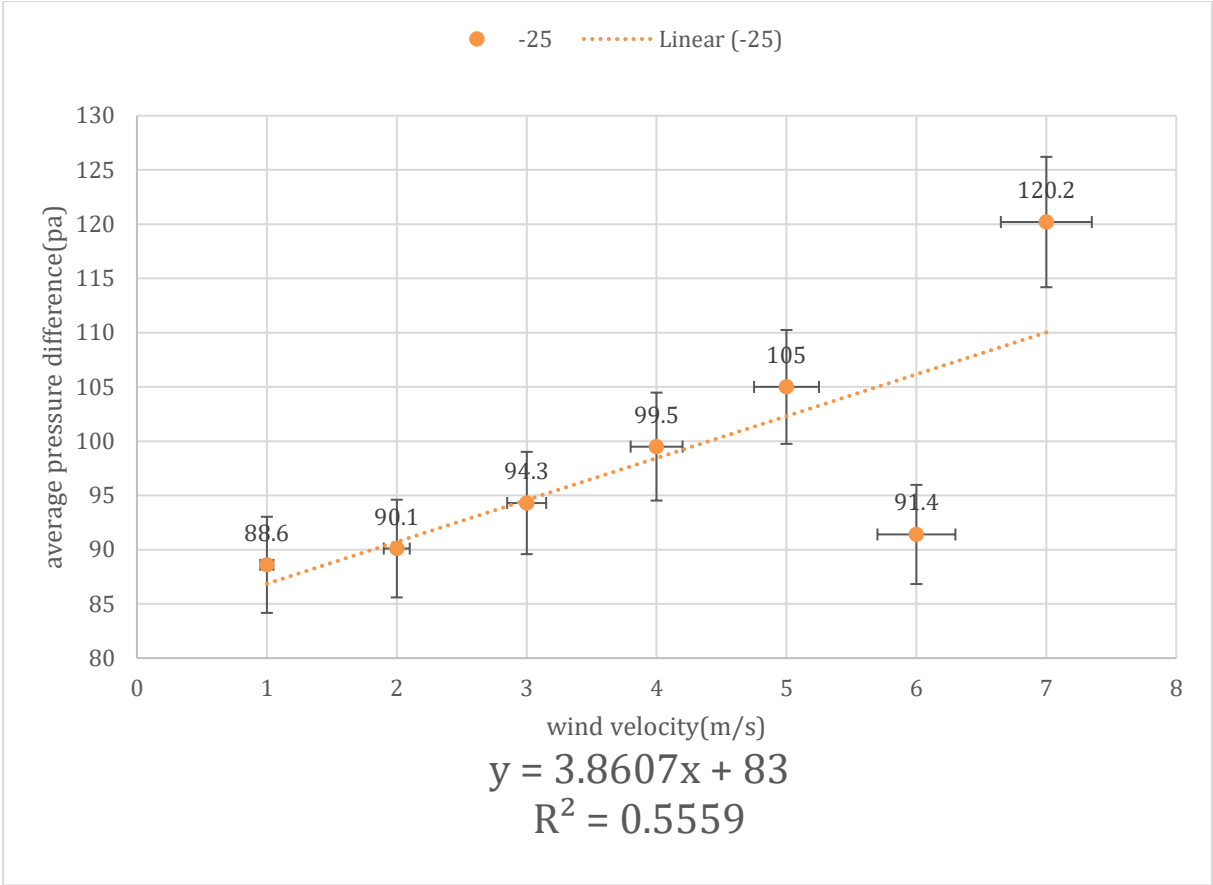

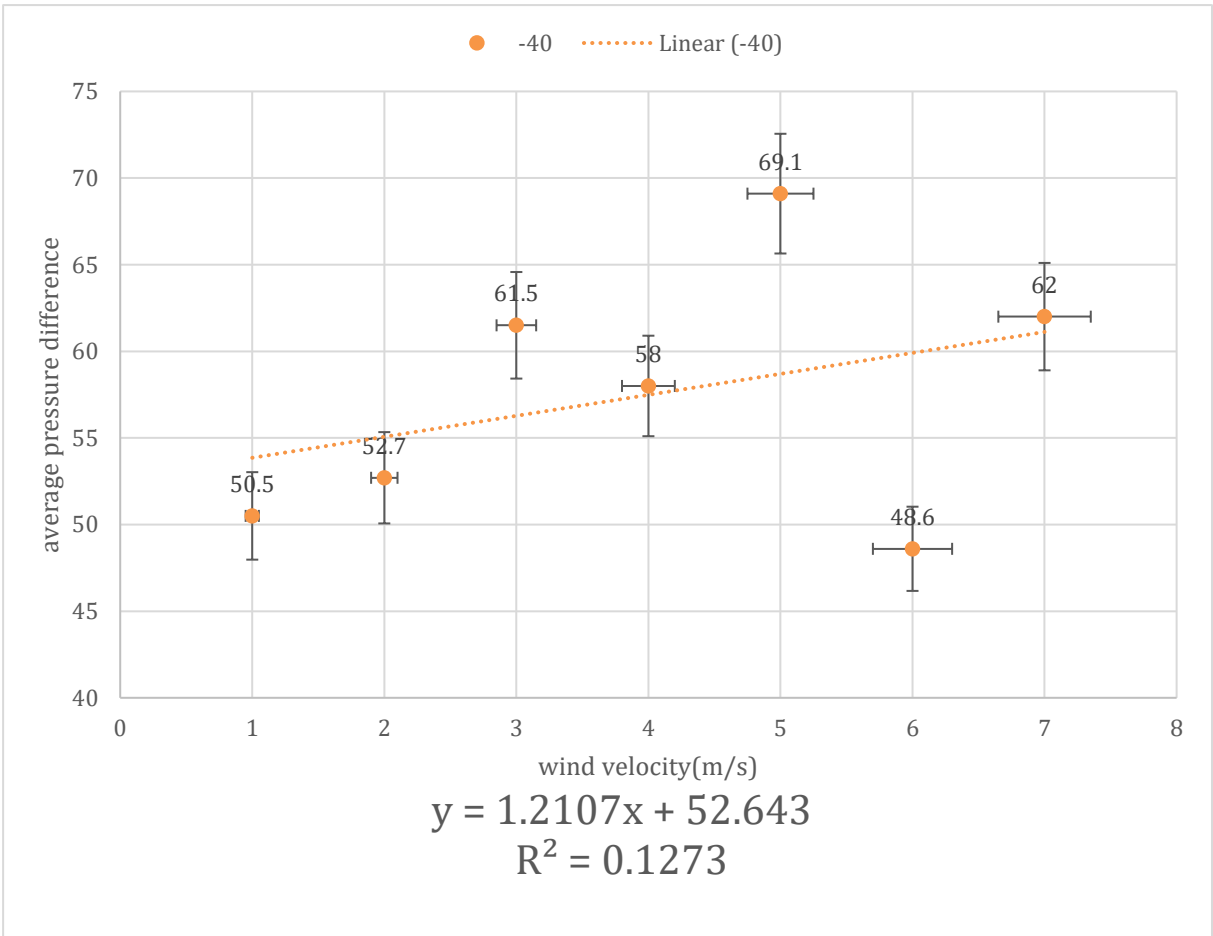
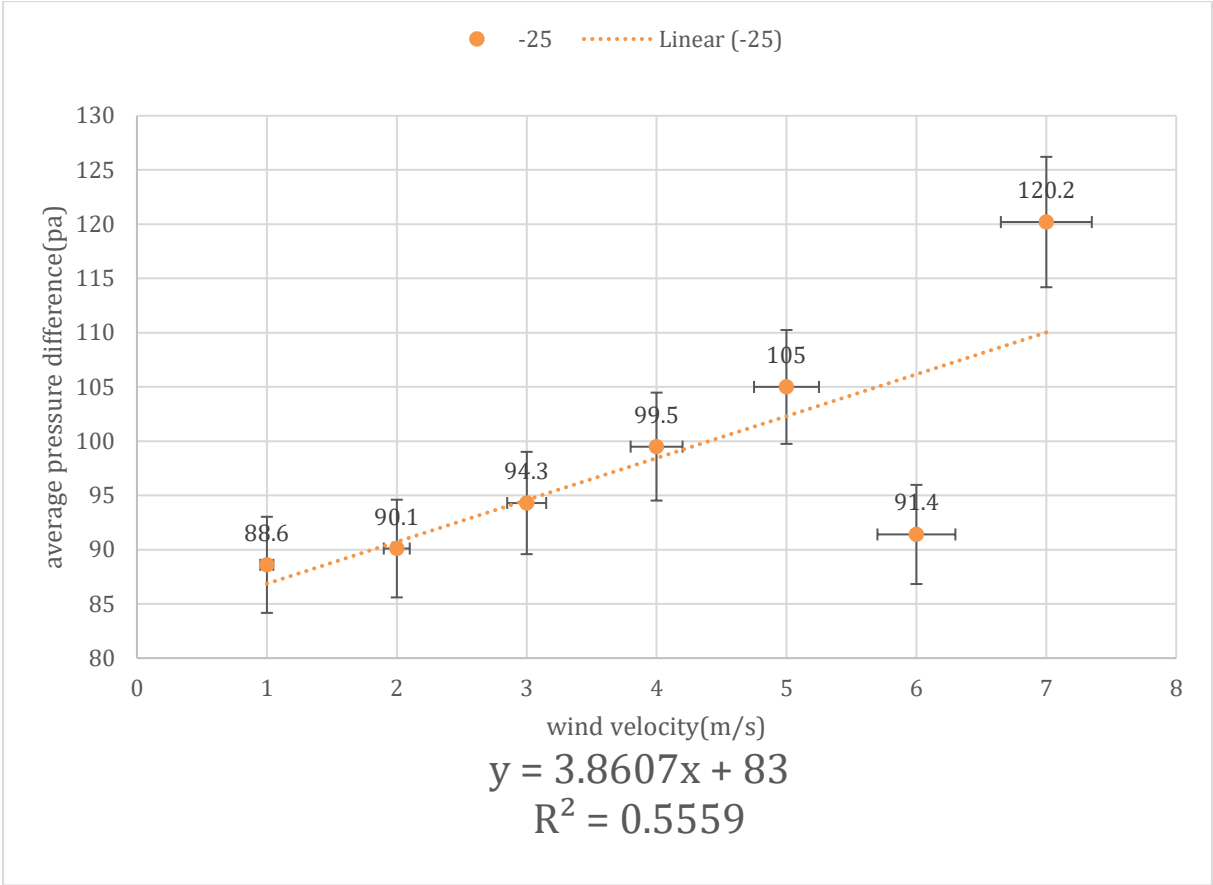

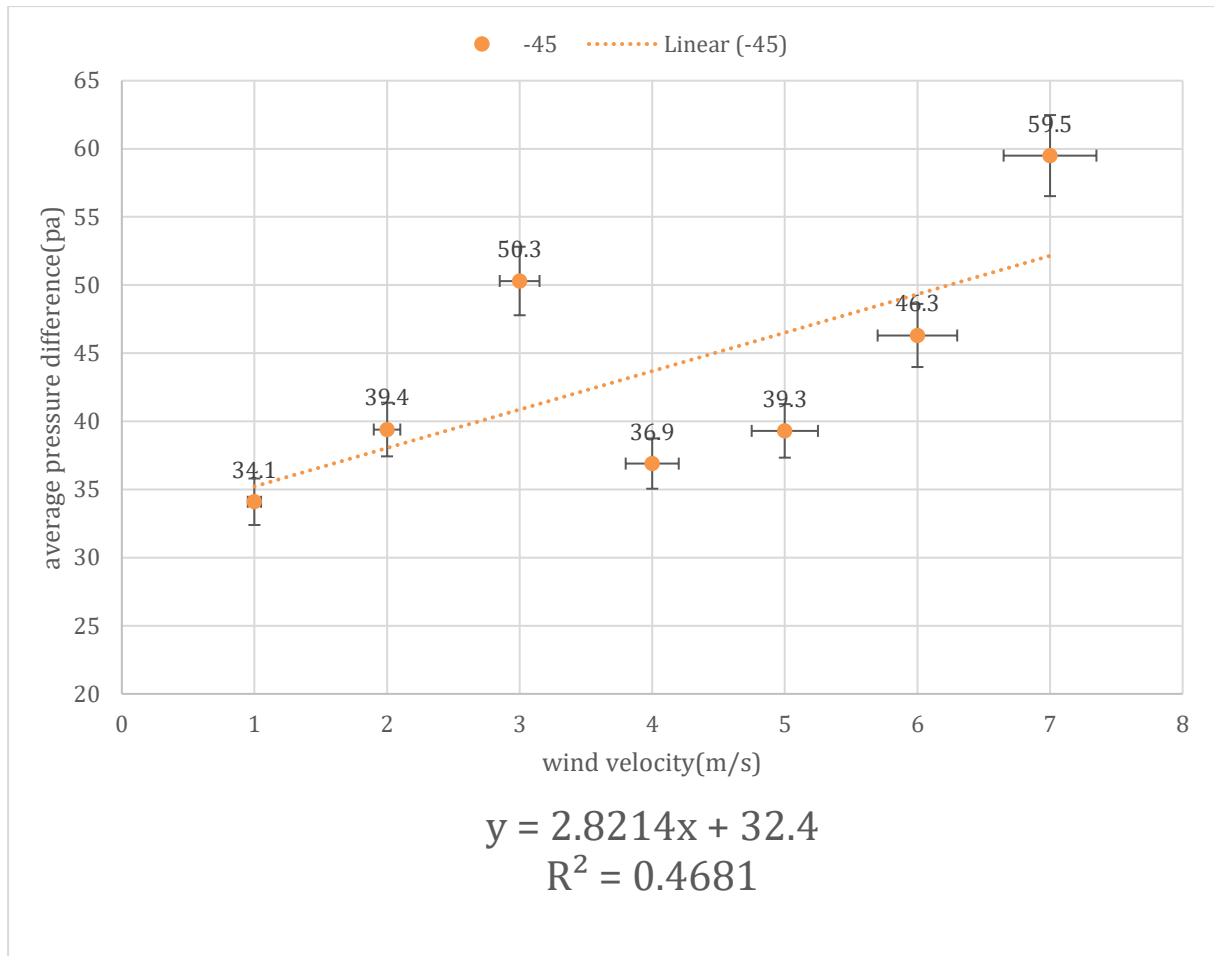

The figures below are graphs showing how pressure difference changes with wind velocity in different ambient temperatures when wind is blowing from **side** and reference pressure sensor is **inside** of the cold box.

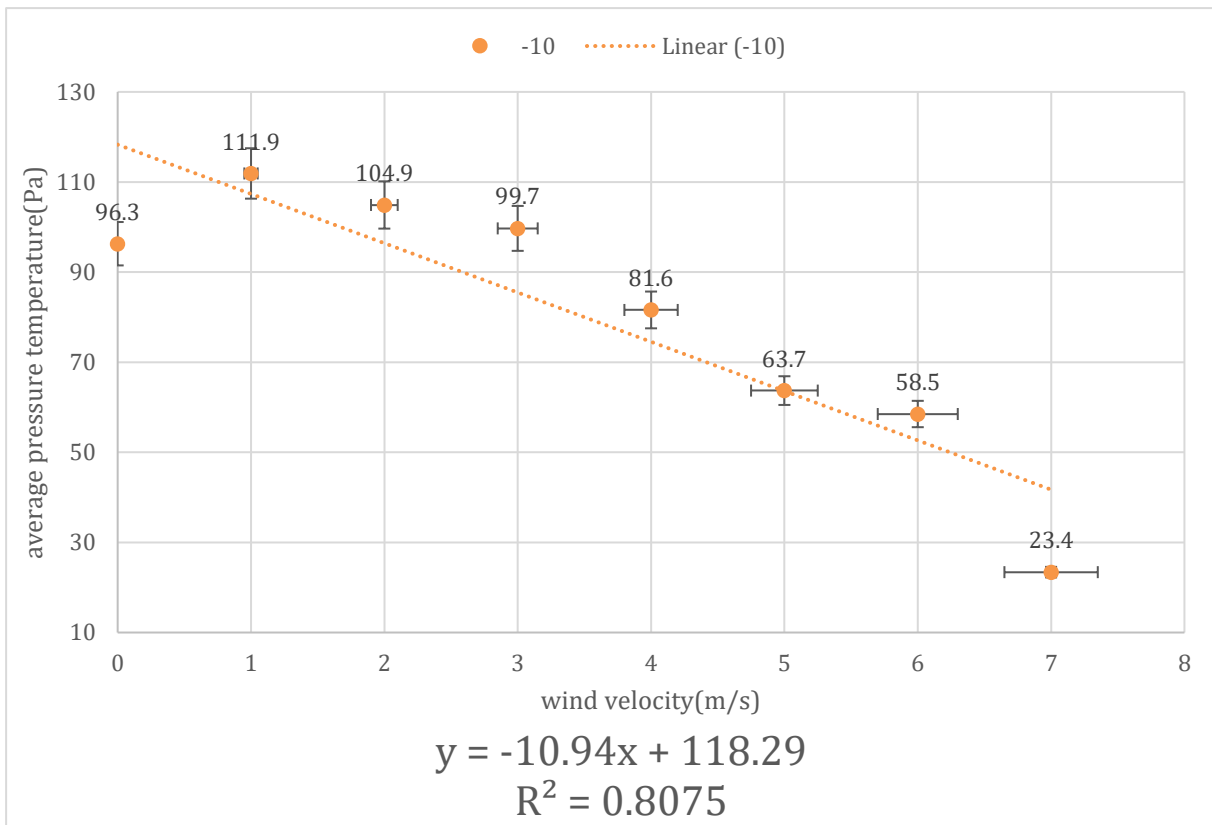
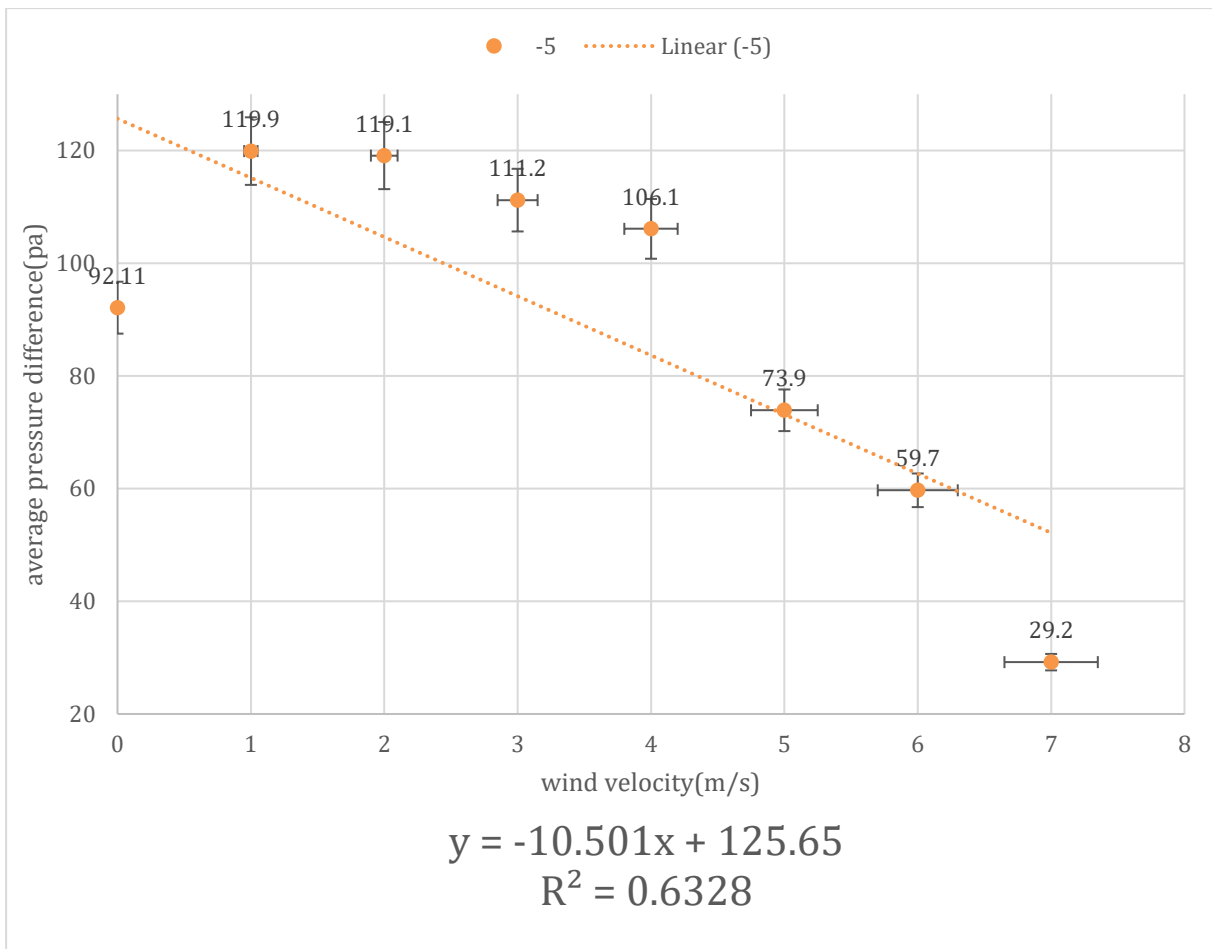

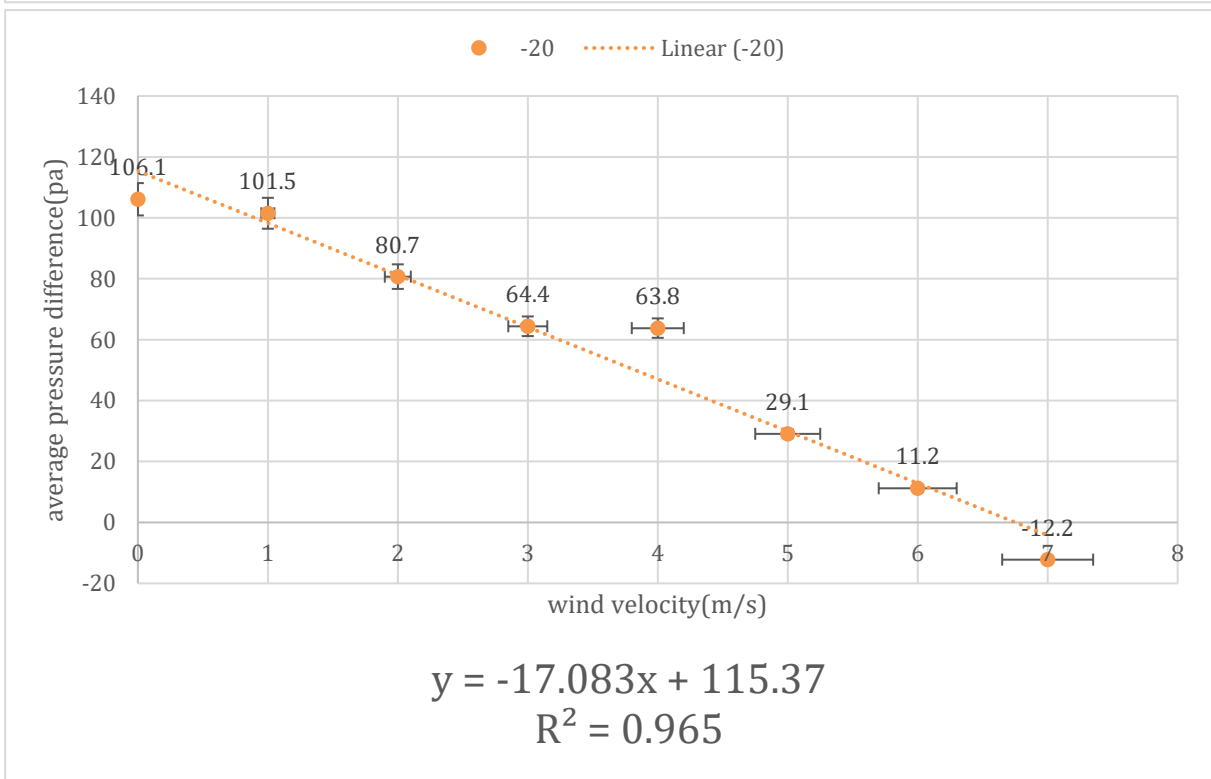
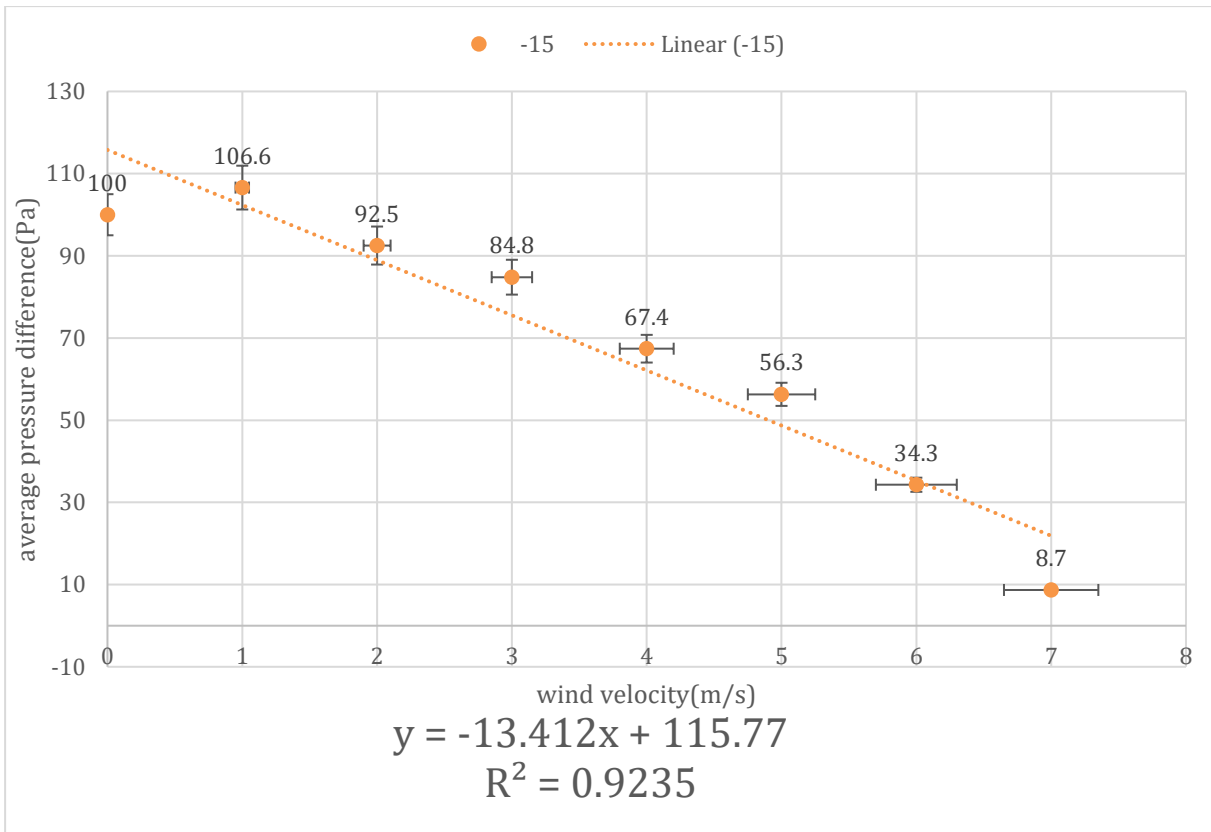



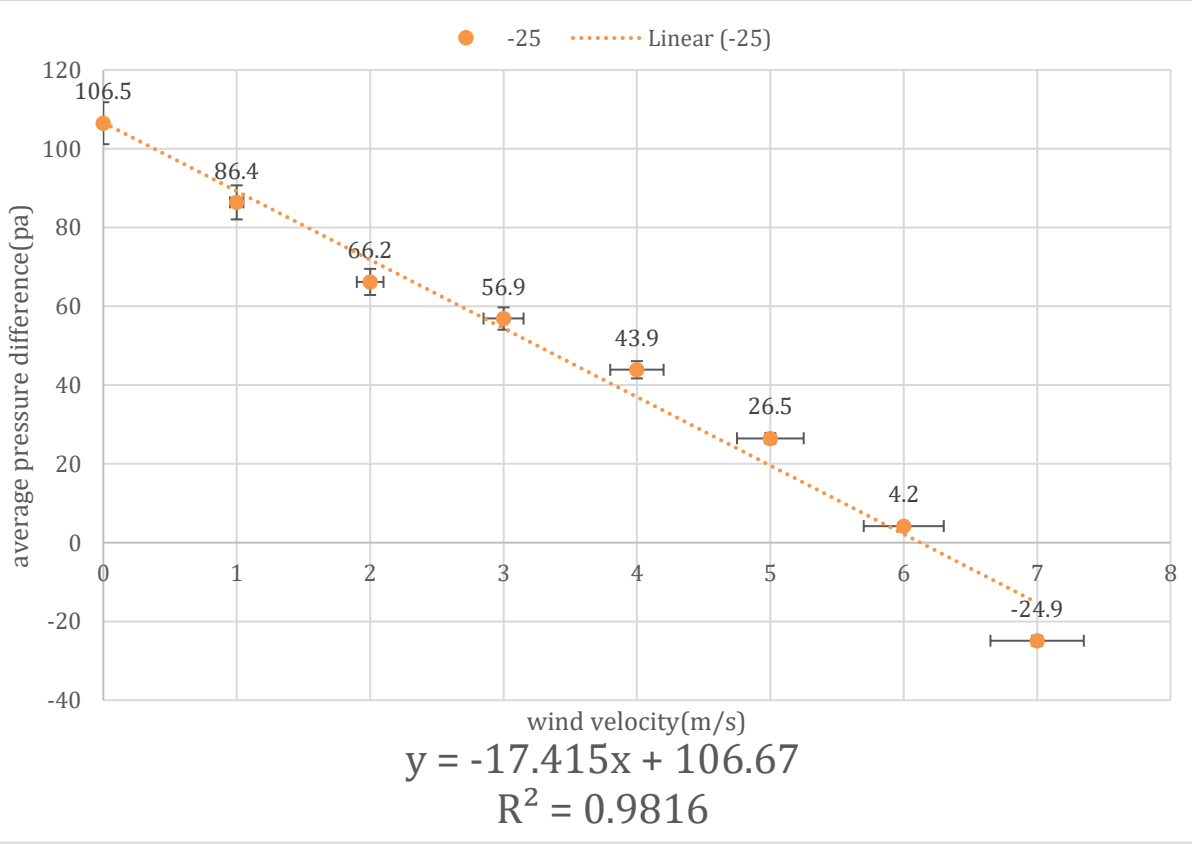
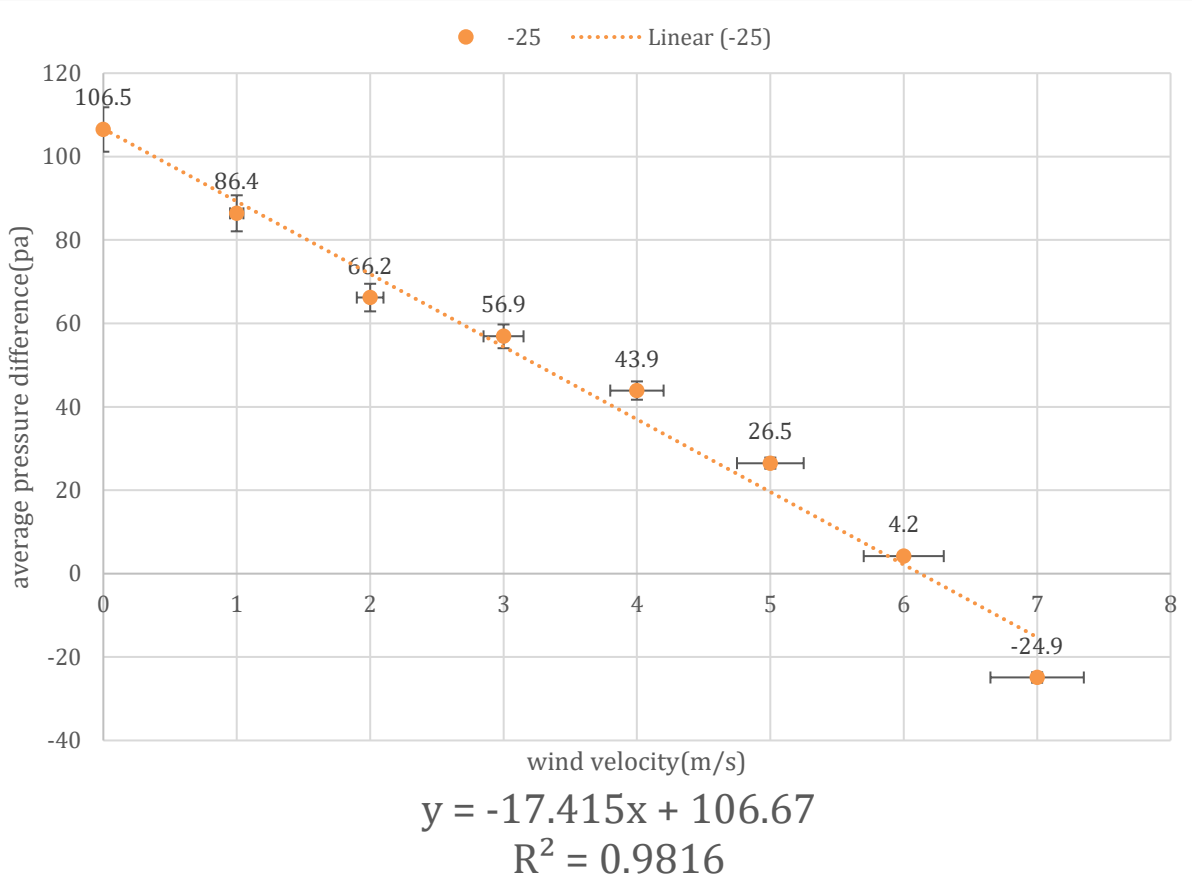

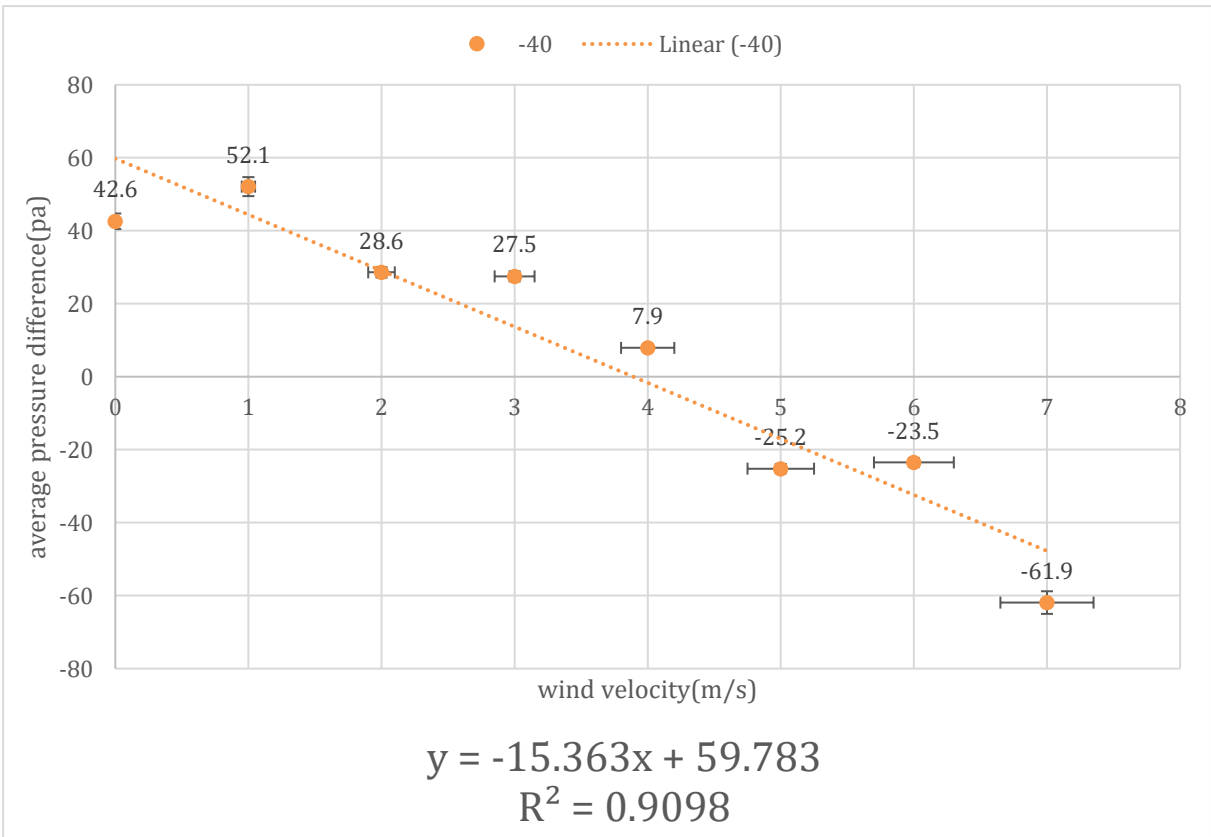
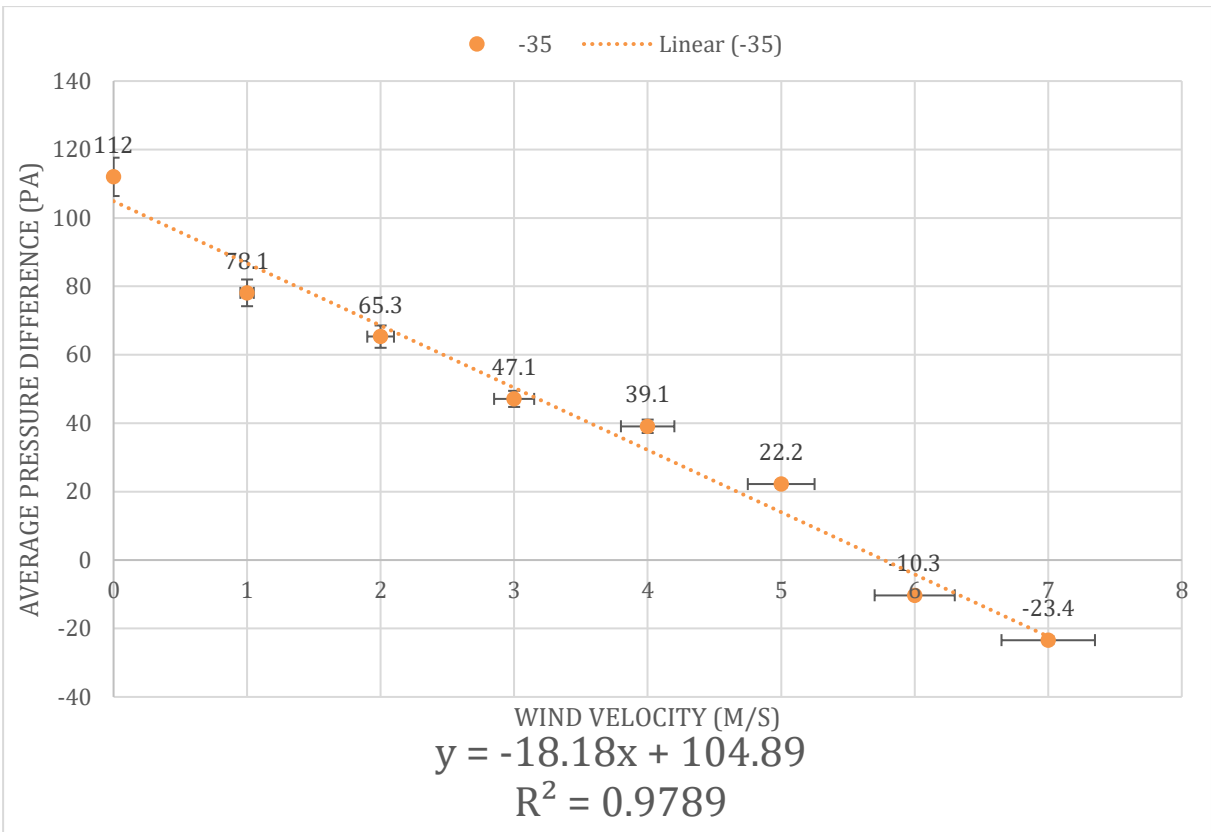

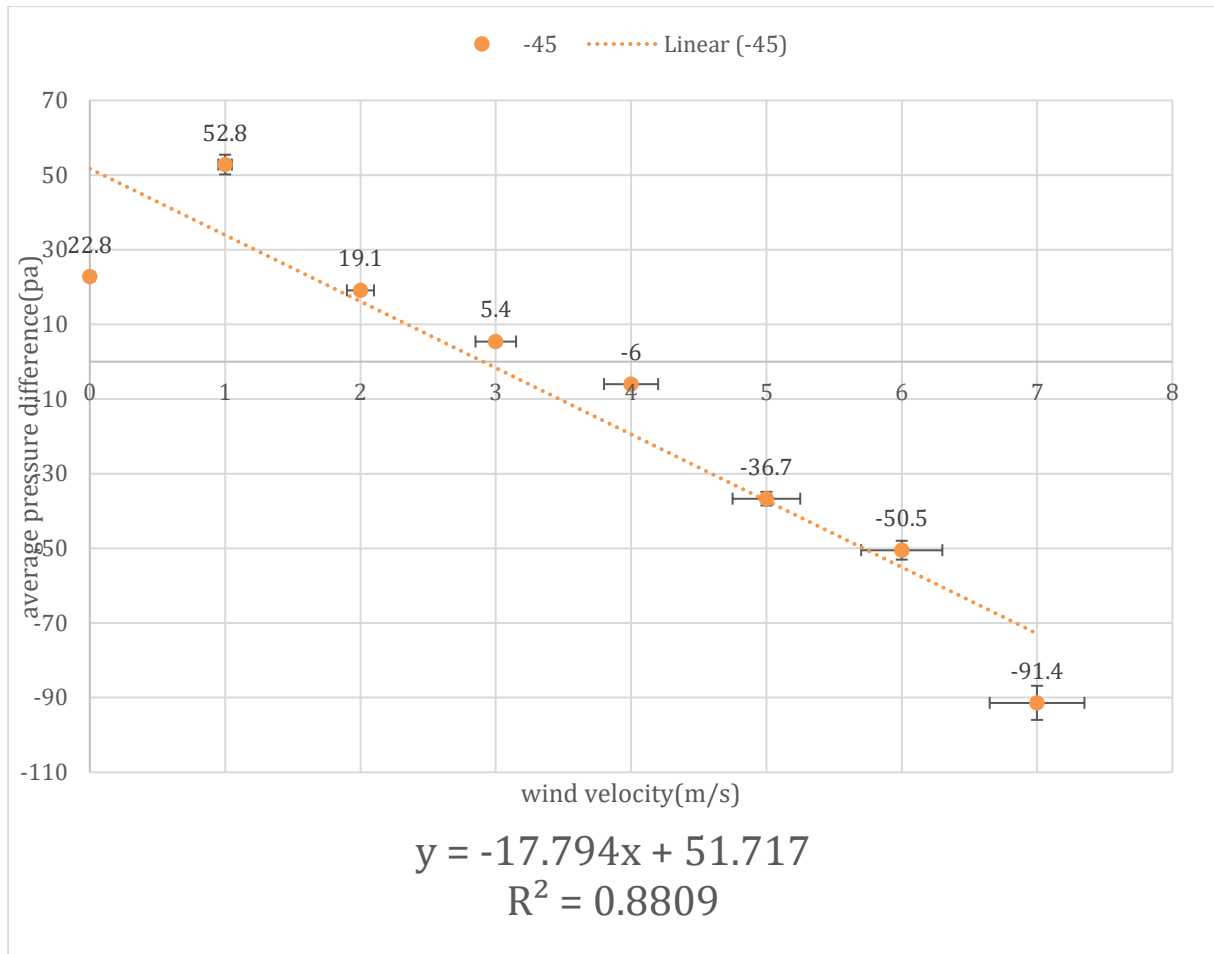

The figures below are graphs showing how pressure difference changes with wind velocity in different ambient temperatures when wind is blowing from **top** and reference pressure sensor is **out** of the cold box.

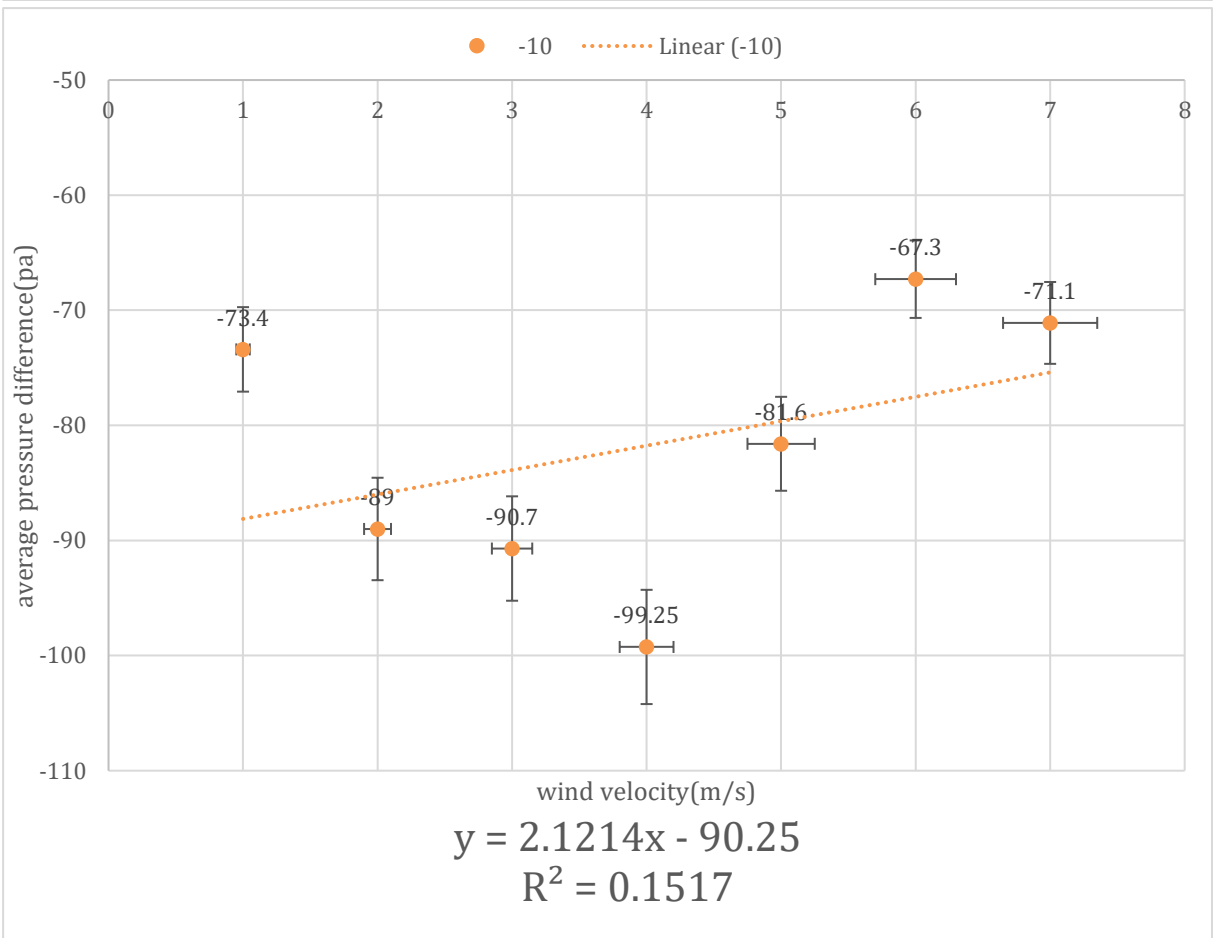
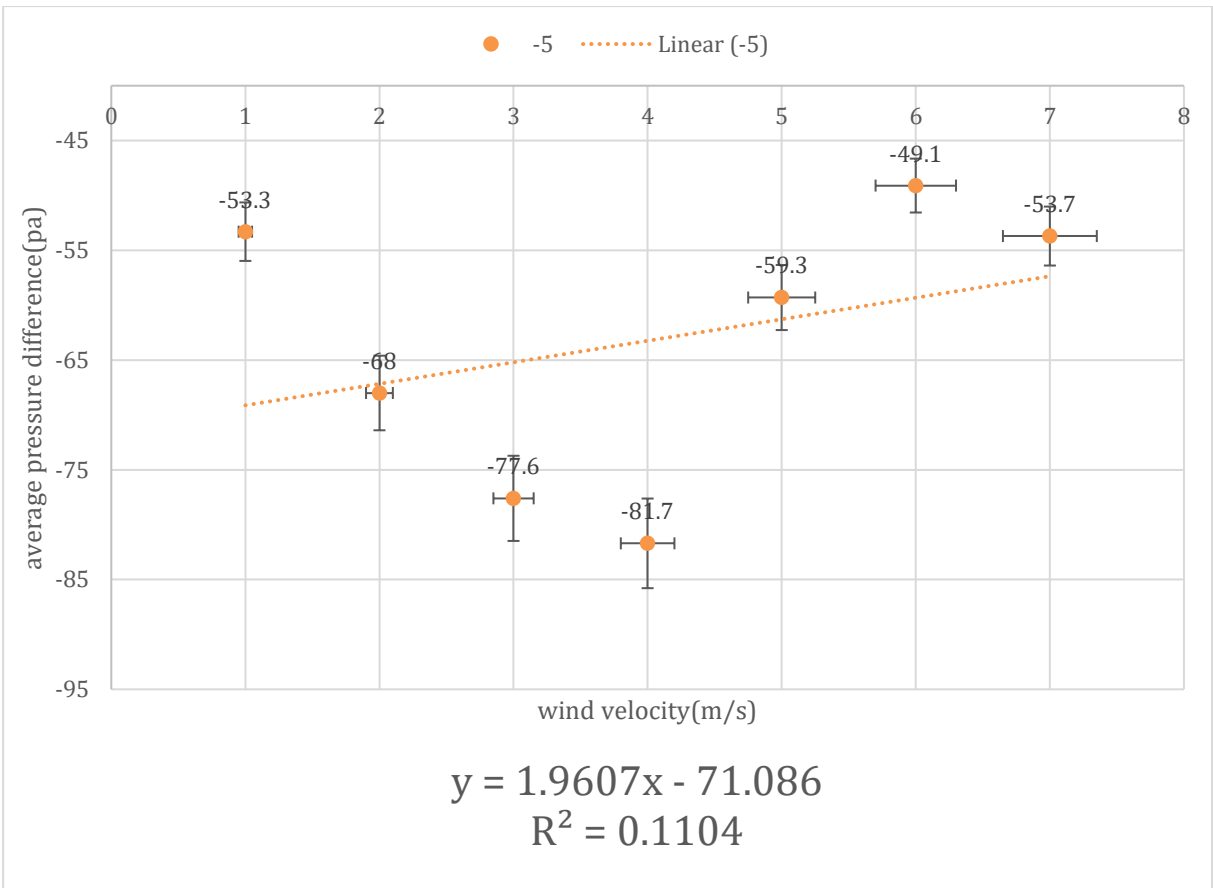

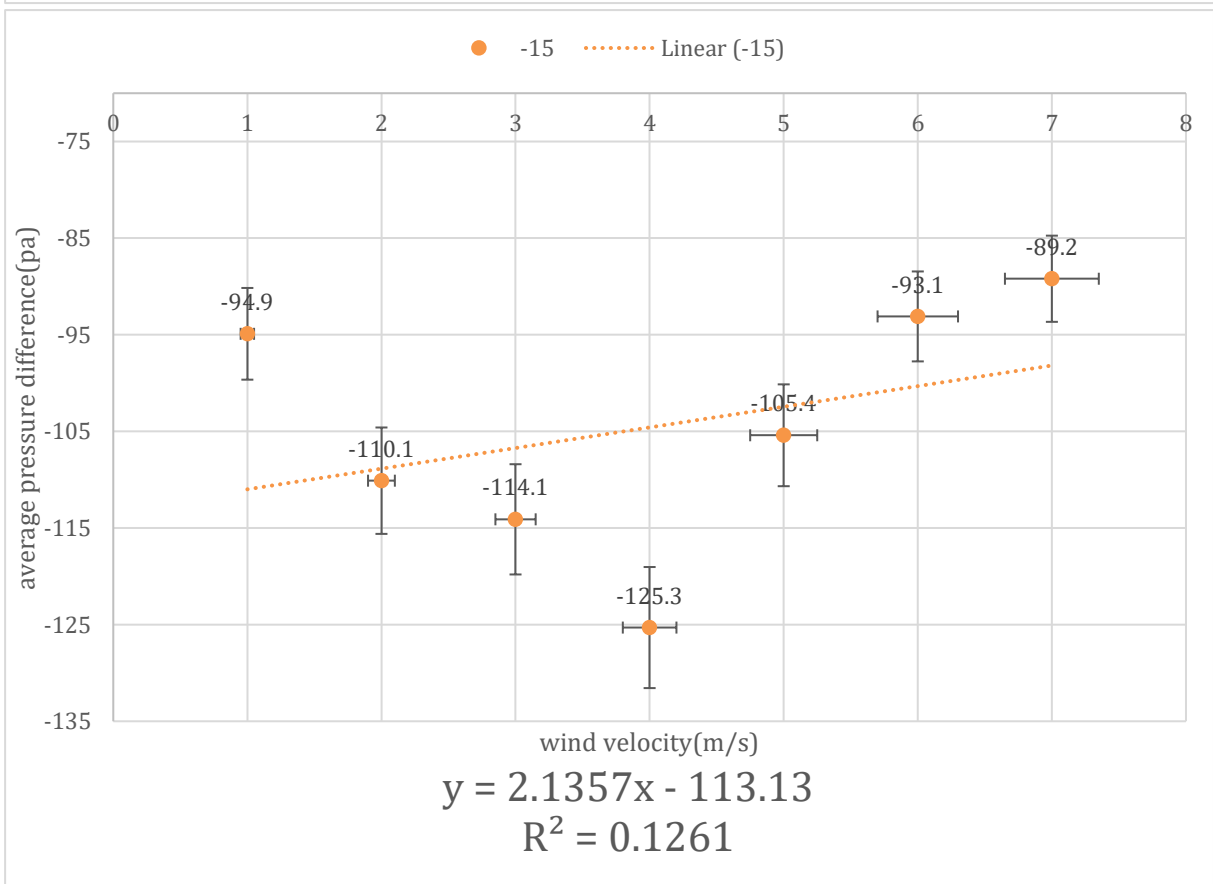
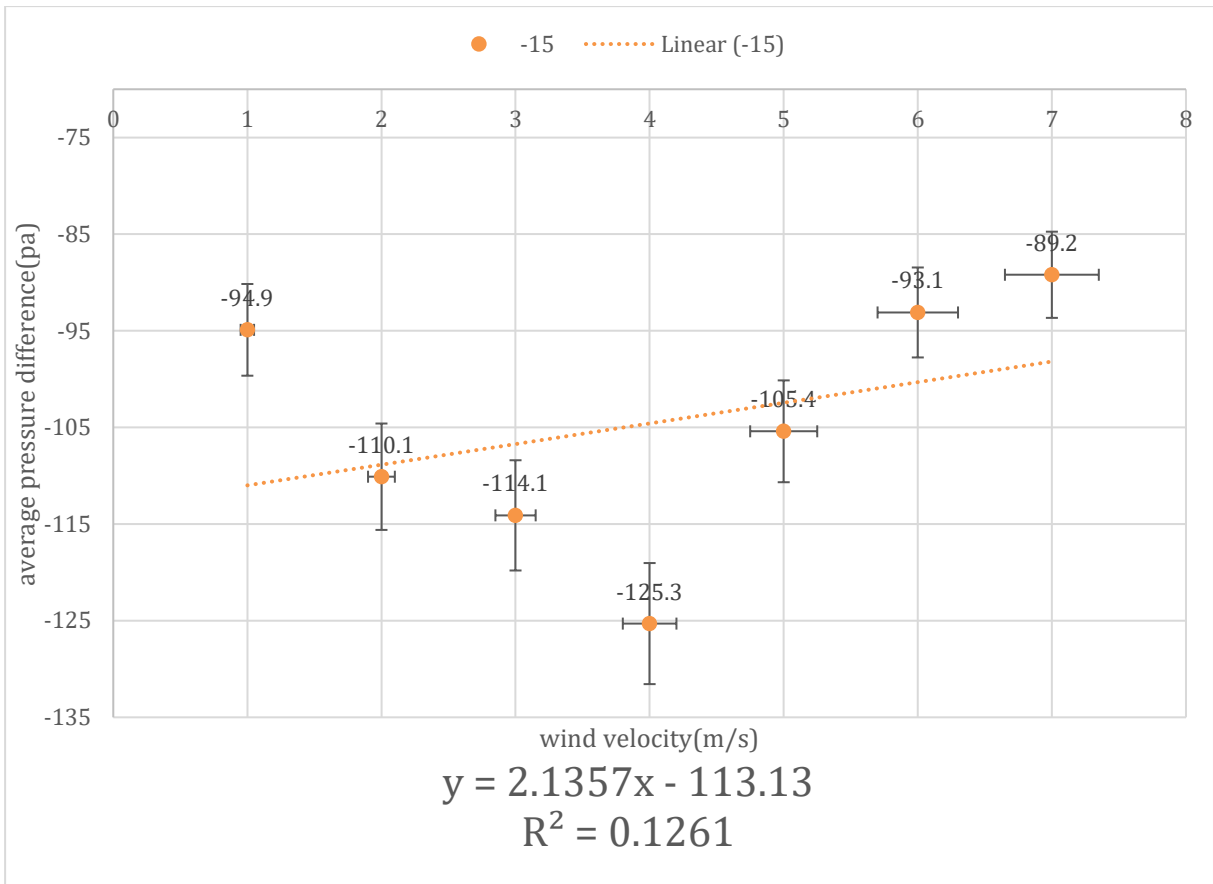

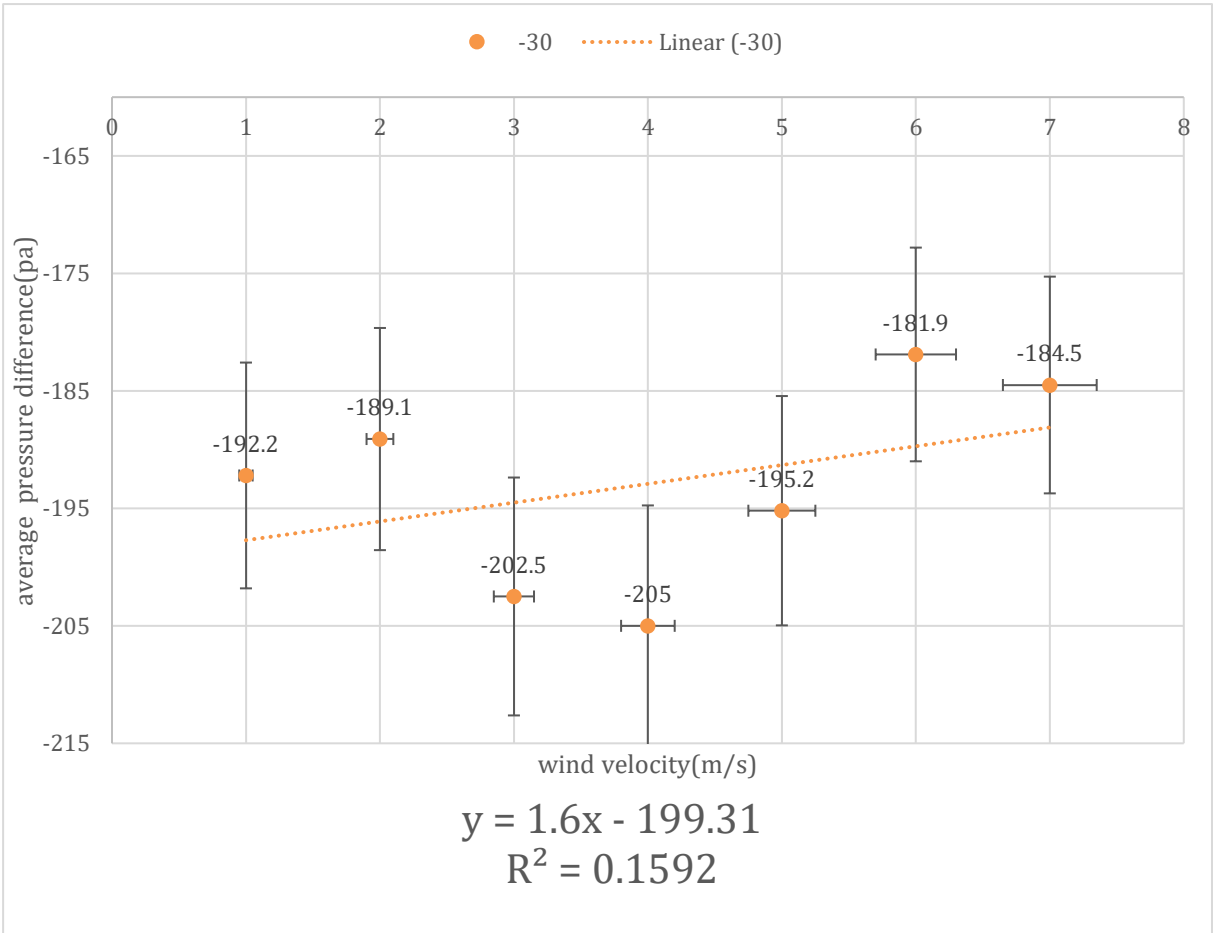
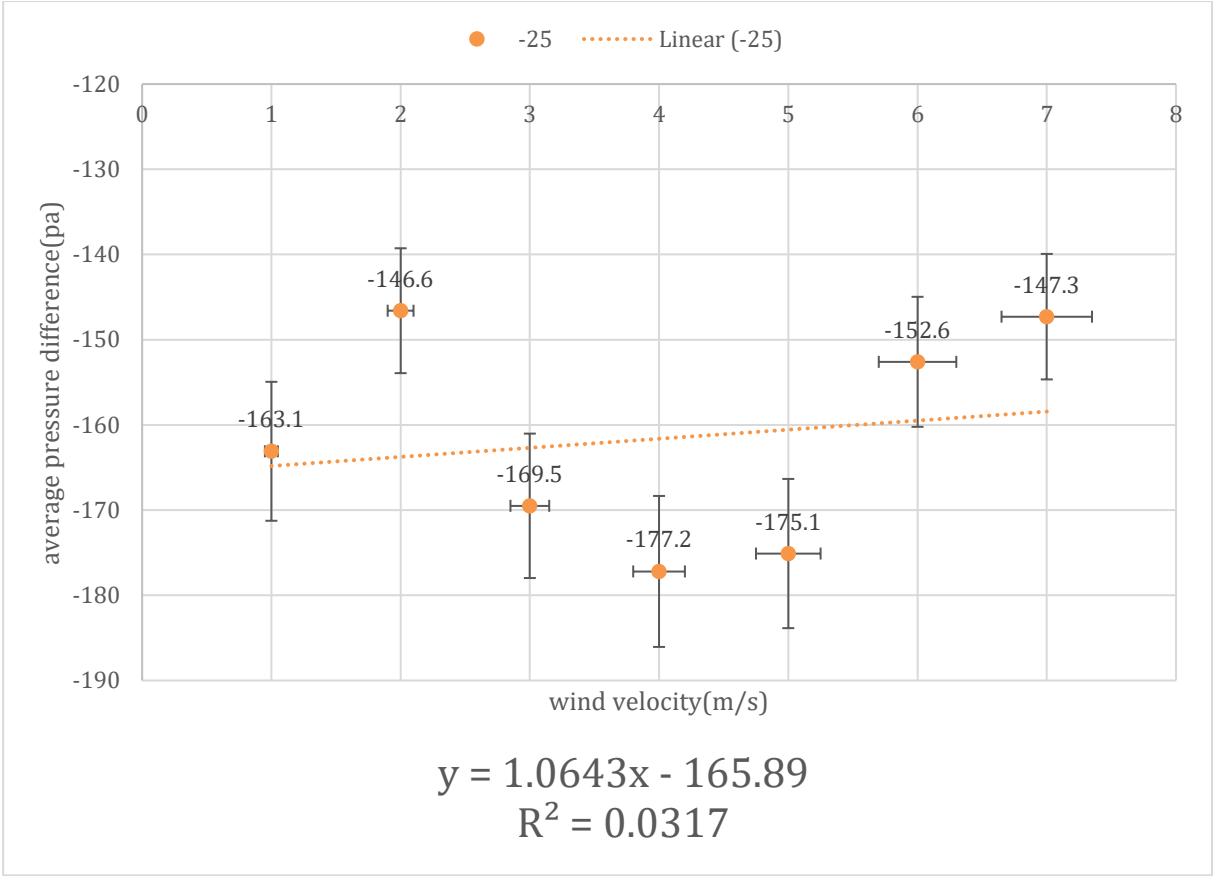

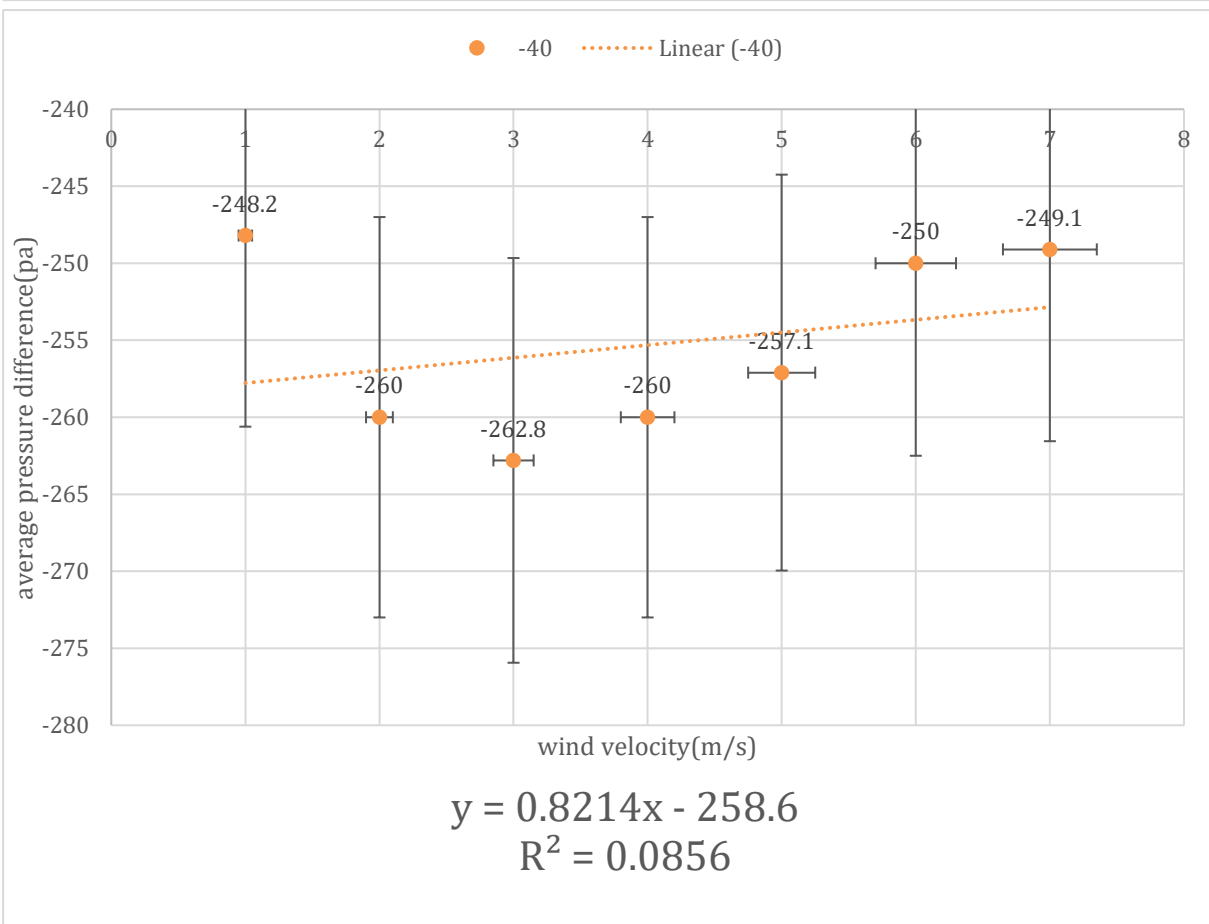
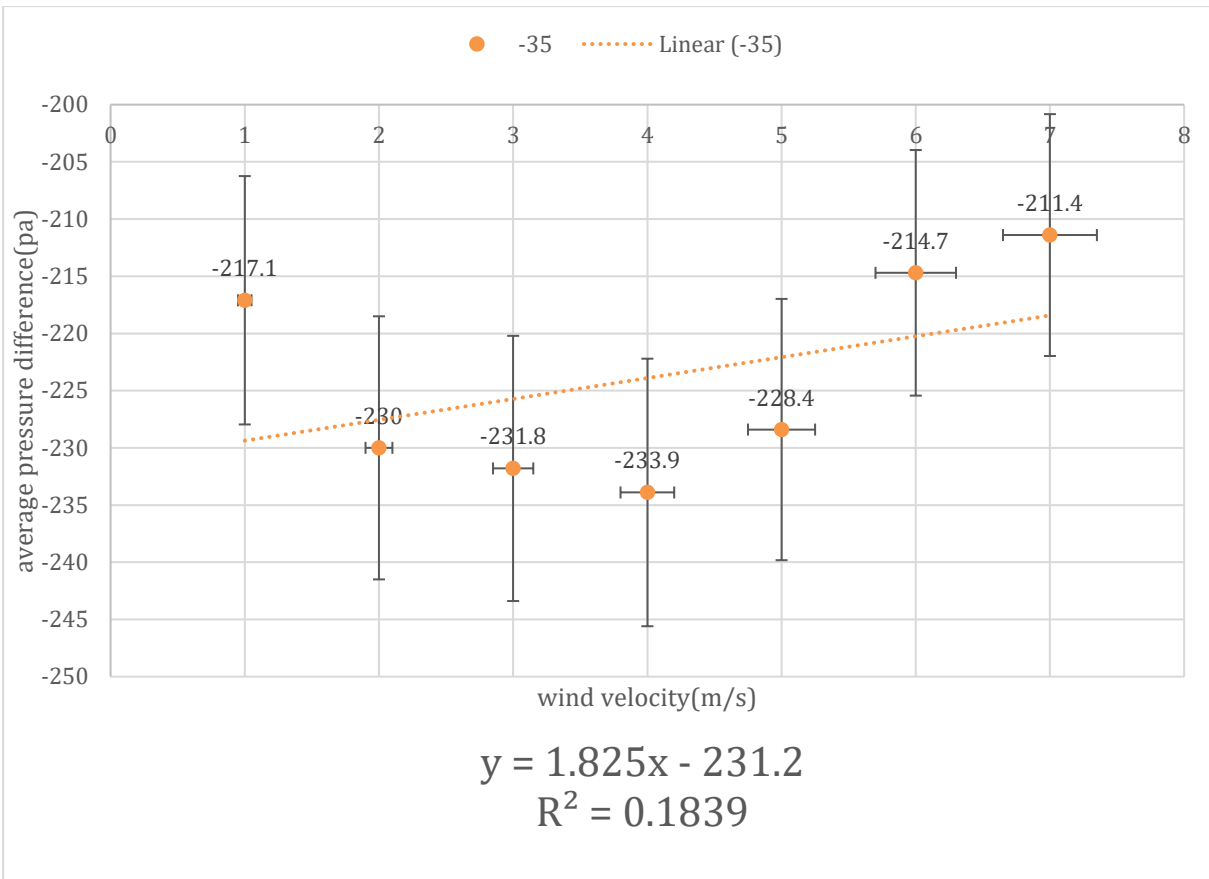

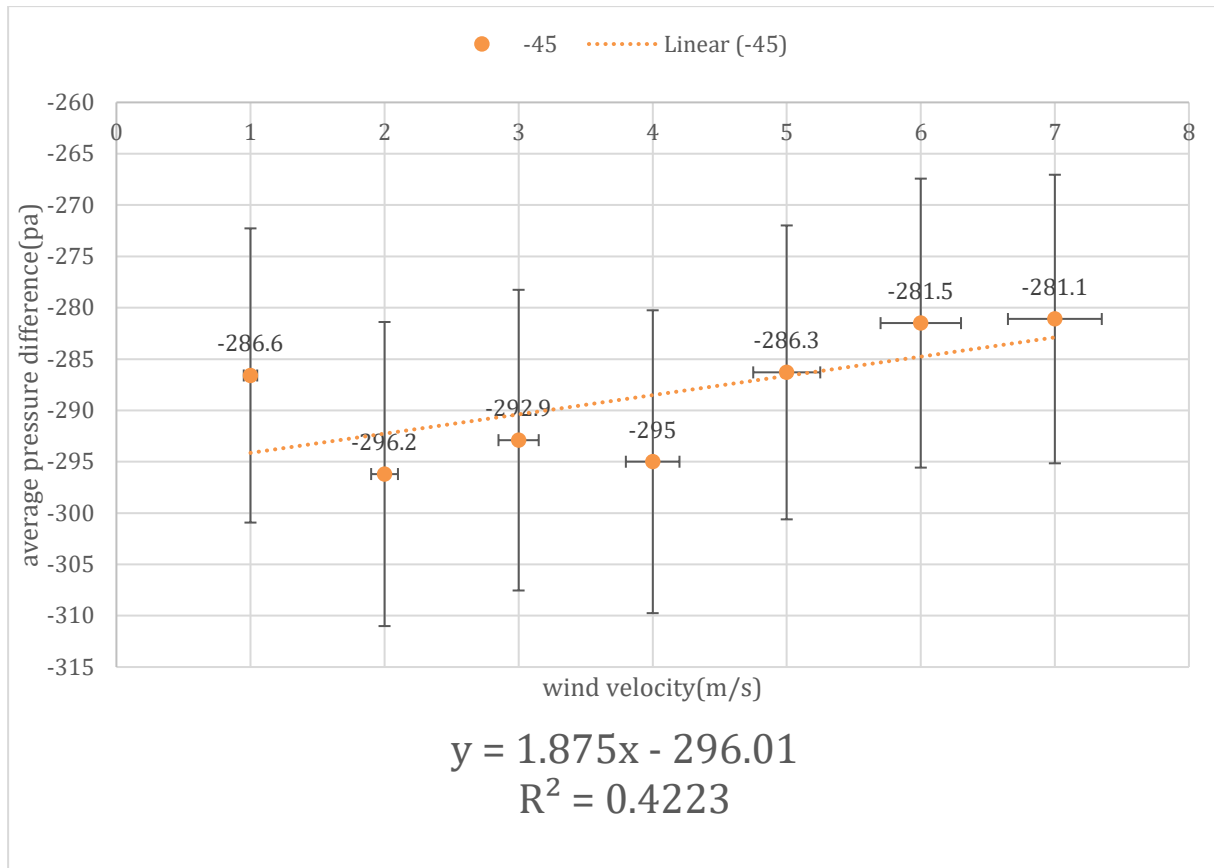

The figures below are graphs showing how pressure difference changes with wind velocity in different ambient temperatures when wind is blowing from **side** and reference pressure sensor is **out** of the cold box.



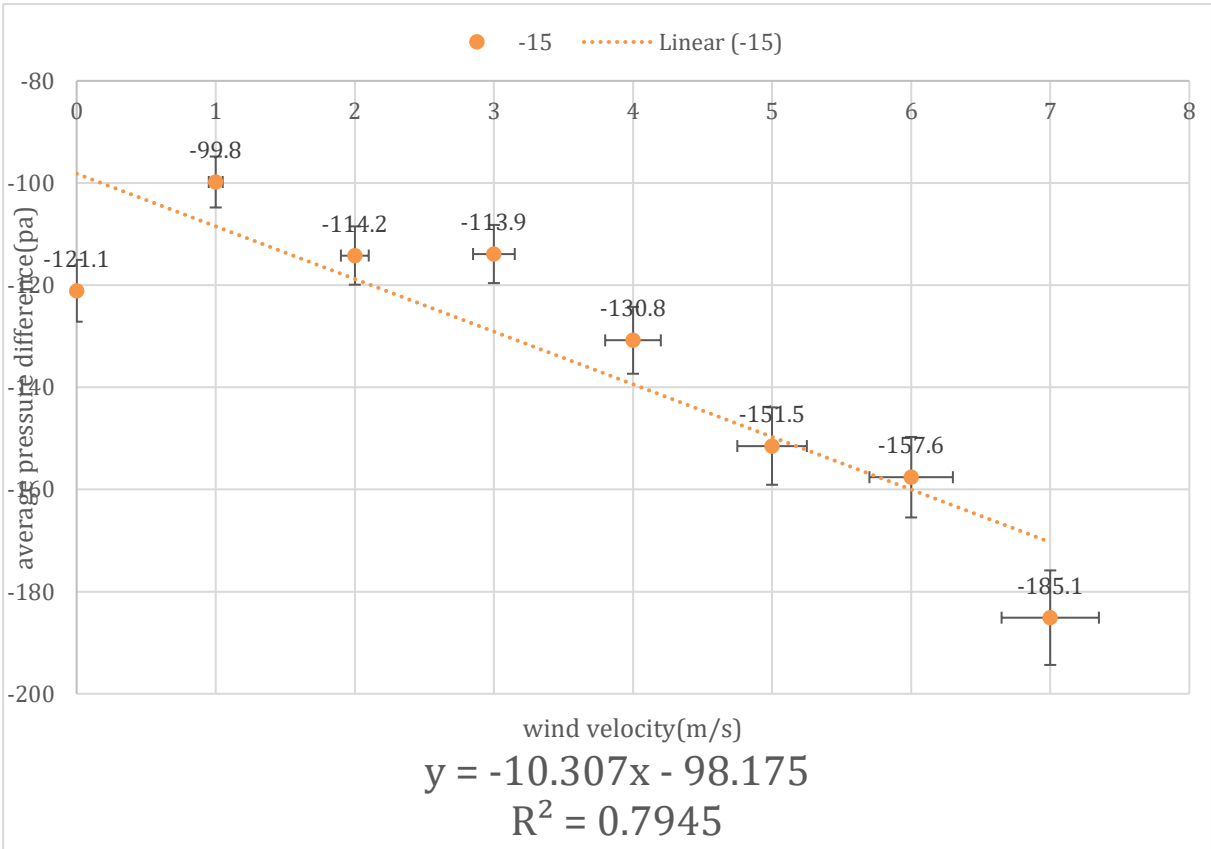
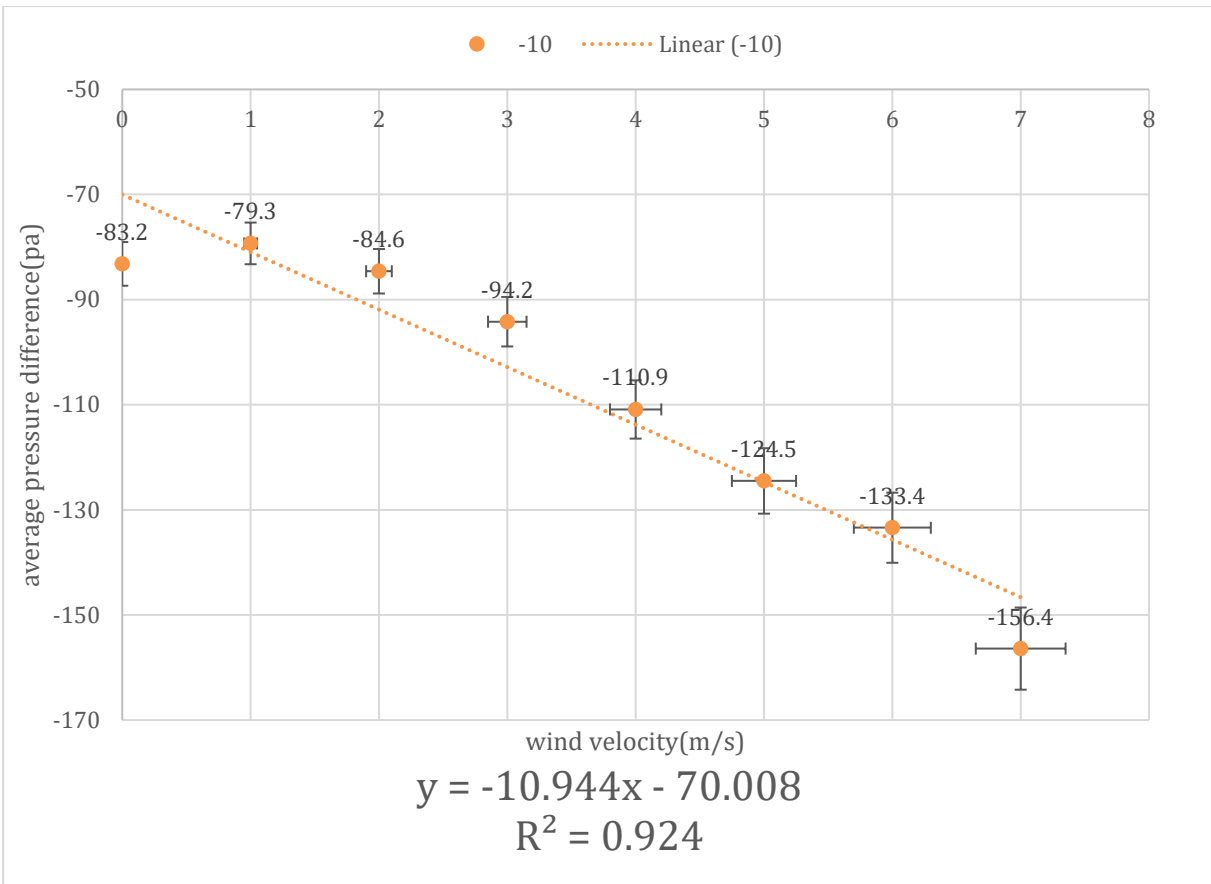

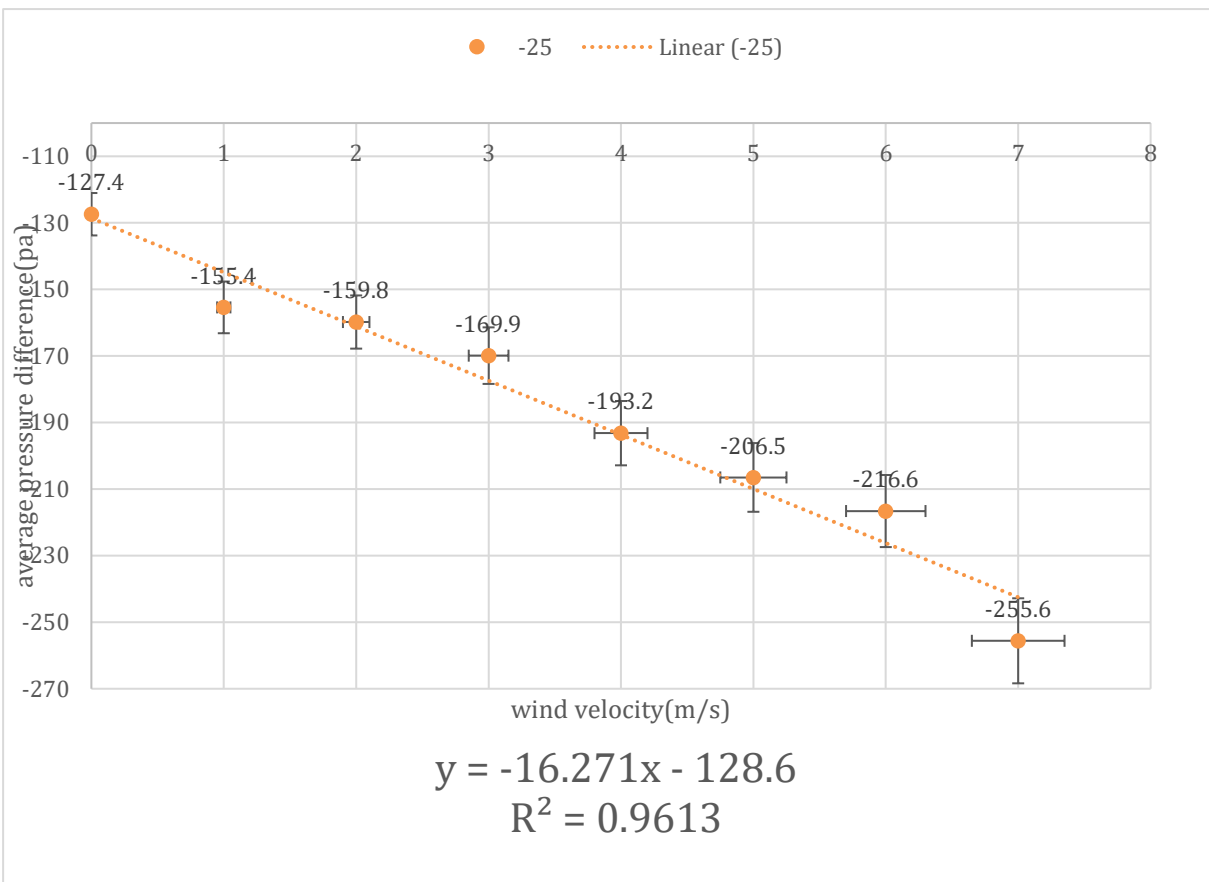
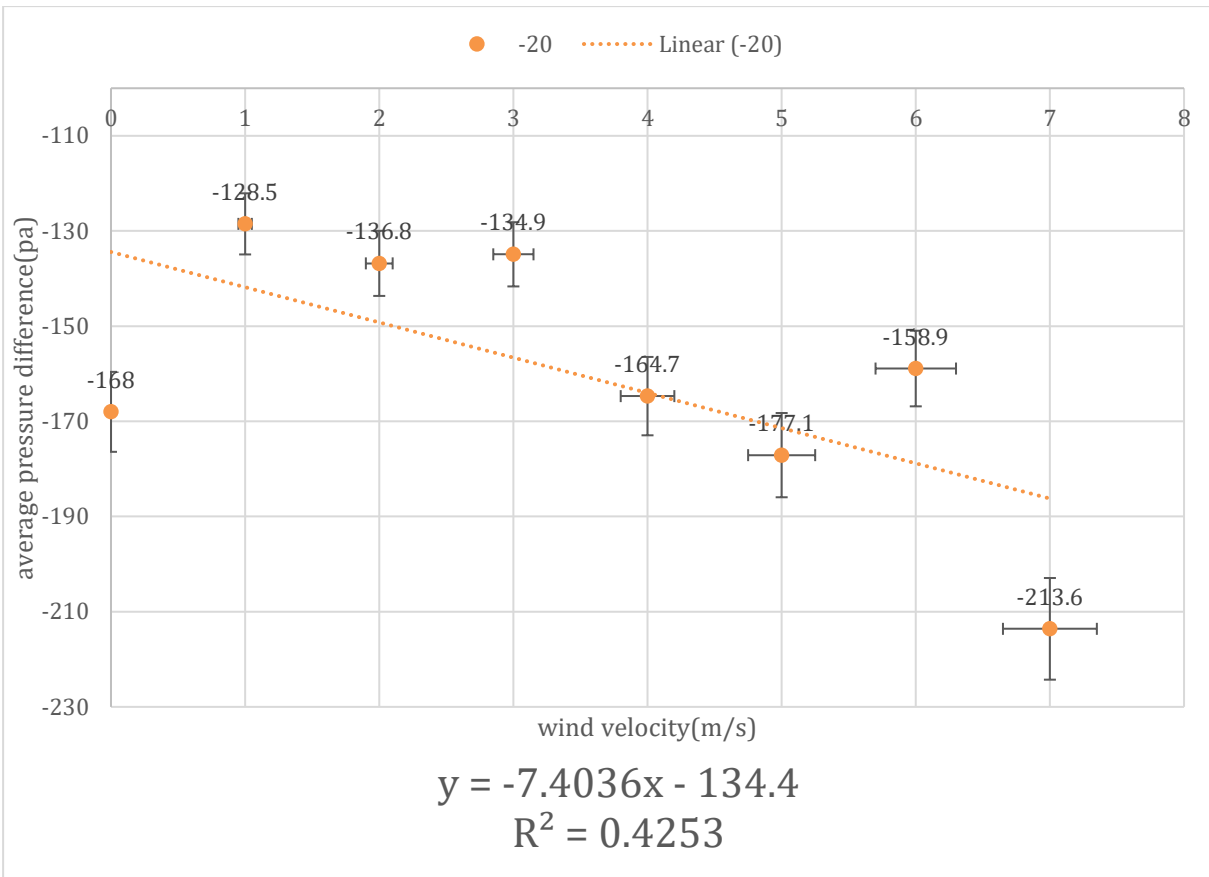

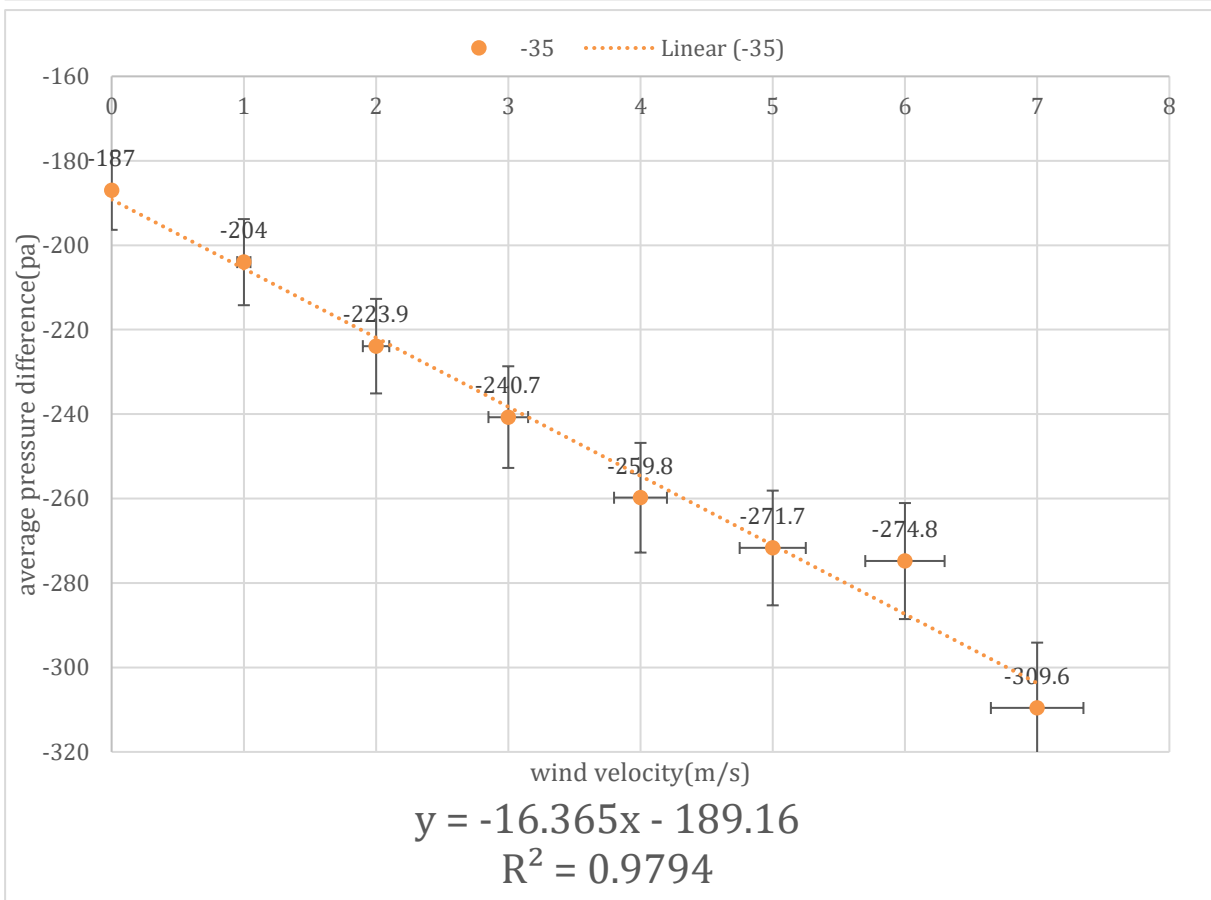
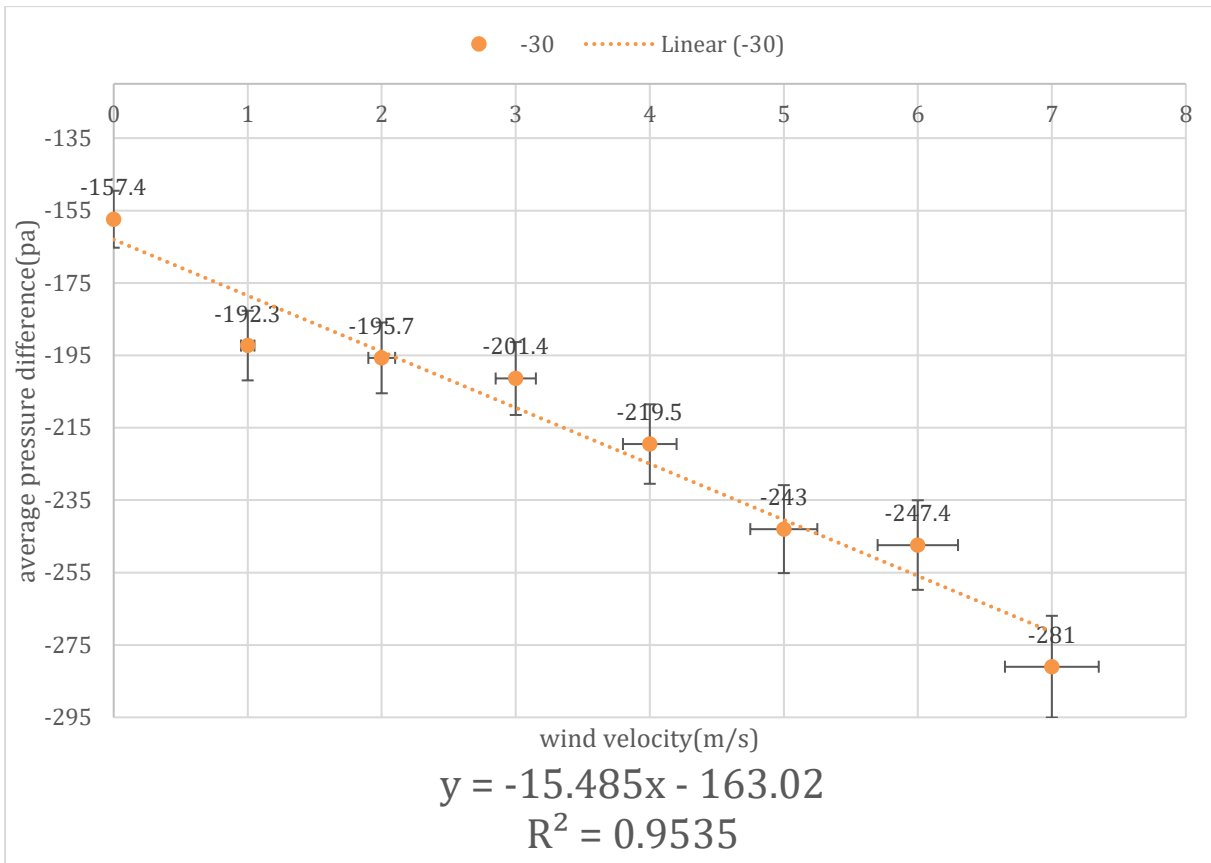

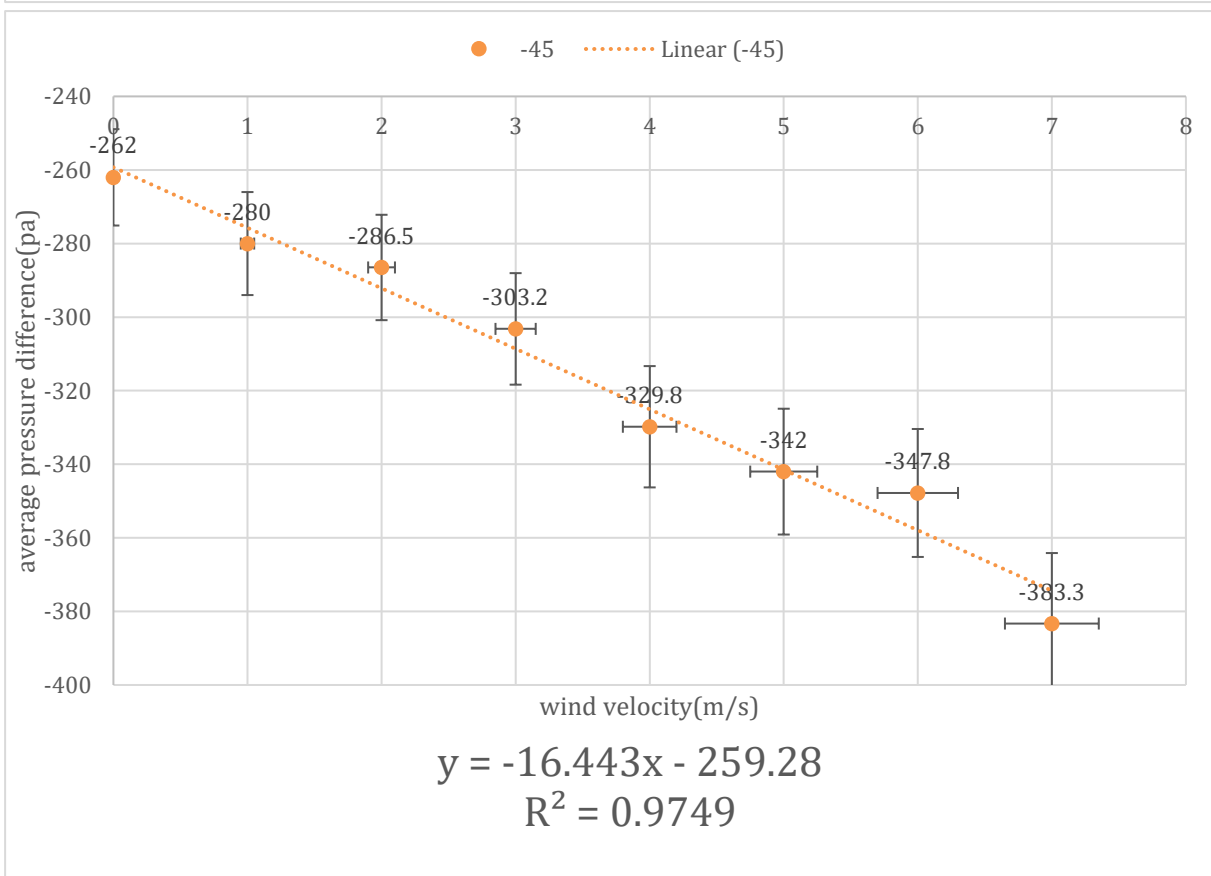
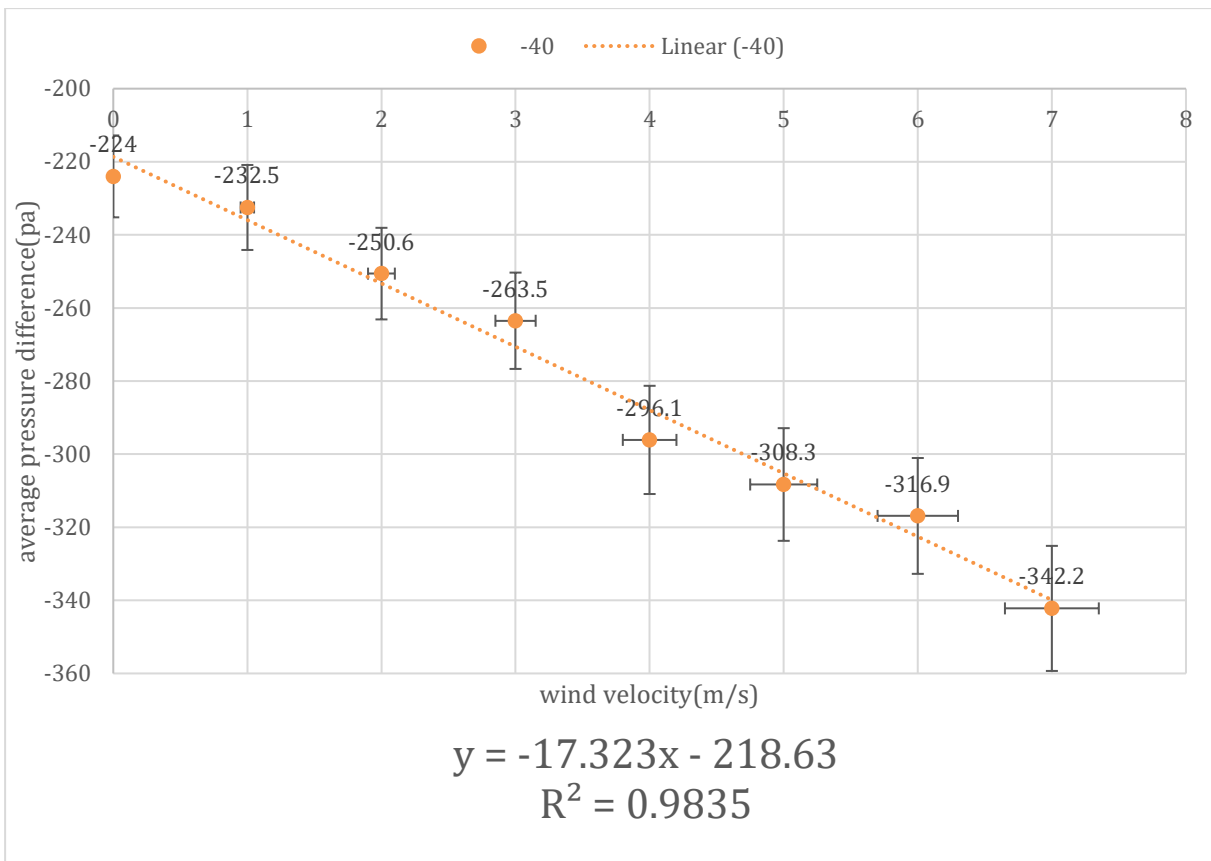

## **APPENDIX II**

Meteorological data during test days

Detailed forecast March 18, 2019

Time	Weather	Temp.	Precipitation	Wind	Pressure	Humidity	Dew point	Cloud cover				
								Total	Fog	Low clouds	Middle clouds	High clouds
12:00		-1°	0 mm	← Light air, 1 m/s from east	1004 hPa	73 %	-6°	52 %	0 %	1 %	5 %	48 %
13:00		-1°	0 mm	↙ Calm, 0 m/s from east-northeast	1004 hPa	75 %	-6°	67 %	0 %	2 %	1 %	65 %
14:00		-1°	0 mm	↙ Light air, 1 m/s from east-northeast	1004 hPa	76 %	-5°	58 %	0 %	0 %	0 %	58 %
15:00		-1°	0 mm	← Light breeze, 2 m/s from east	1005 hPa	73 %	-5°	32 %	0 %	0 %	0 %	32 %
16:00		-2°	0 mm	↘ Light breeze, 3 m/s from east-southeast	1005 hPa	69 %	-6°	11 %	0 %	0 %	0 %	11 %
17:00		-2°	0 mm	↘ Light breeze, 3 m/s from east-southeast	1005 hPa	68 %	-7°	0 %	0 %	0 %	0 %	0 %
18:00		-3°	0 mm	↘ Light breeze, 3 m/s from southeast	1006 hPa	68 %	-8°	0 %	0 %	0 %	0 %	0 %
19:00		-3°	0 mm	↘ Light breeze, 3 m/s from southeast	1006 hPa	69 %	-8°	0 %	0 %	0 %	0 %	0 %
20:00		-4°	0 mm	↘ Light breeze, 3 m/s from southeast	1007 hPa	68 %	-8°	0 %	0 %	0 %	0 %	0 %
21:00		-4°	0 mm	↘ Light breeze, 3 m/s from southeast	1007 hPa	67 %	-8°	0 %	0 %	0 %	0 %	0 %
22:00		-4°	0 mm	↘ Light breeze, 3 m/s from southeast	1008 hPa	68 %	-8°	0 %	0 %	0 %	0 %	0 %
23:00		-5°	0 mm	↘ Light breeze, 3 m/s from south-southeast	1008 hPa	73 %	-9°	0 %	0 %	0 %	0 %	0 %

Detailed forecast March 19, 2019

Time	Weather	Temp.	Precipitation	Wind	Pressure	Humidity	Dew point	Cloud cover				
								Total	Fog	Low clouds	Middle clouds	High clouds

Time	Weather	Temp.	Precipitation	Wind	Pressure	Humidity	Dew point	Cloud cover				
								Total	Fog	Low clouds	Middle clouds	High clouds
00:00		-5°	0 mm	Gentle breeze, 4 m/s from south-southeast	1009 hPa	75 %	-8°	0 %	0 %	0 %	0 %	0 %
01:00		-5°	0 mm	Light breeze, 3 m/s from south-southeast	1009 hPa	74 %	-8°	6 %	0 %	0 %	0 %	6 %
02:00		-5°	0 mm	Light breeze, 3 m/s from south-southeast	1010 hPa	74 %	-8°	3 %	0 %	0 %	0 %	3 %
03:00		-5°	0 mm	Gentle breeze, 4 m/s from south-southeast	1010 hPa	74 %	-8°	1 %	0 %	0 %	0 %	0 %
04:00		-5°	0 mm	Gentle breeze, 4 m/s from south-southeast	1011 hPa	73 %	-8°	1 %	0 %	0 %	0 %	0 %
05:00		-5°	0 mm	Gentle breeze, 4 m/s from south-southeast	1011 hPa	73 %	-8°	0 %	0 %	0 %	0 %	0 %
06:00		-4°	0 mm	Gentle breeze, 4 m/s from south-southeast	1011 hPa	73 %	-8°	0 %	0 %	0 %	0 %	0 %
07:00		-4°	0 mm	Gentle breeze, 5 m/s from south-southeast	1011 hPa	73 %	-8°	0 %	0 %	0 %	0 %	0 %
08:00		-4°	0 mm	Gentle breeze, 5 m/s from south-southeast	1011 hPa	72 %	-8°	0 %	0 %	0 %	0 %	0 %
09:00		-3°	0 mm	Gentle breeze, 5 m/s from south-southeast	1011 hPa	72 %	-7°	0 %	0 %	0 %	0 %	0 %
10:00		-2°	0 mm	Gentle breeze, 5 m/s from south-southeast	1012 hPa	71 %	-6°	0 %	0 %	0 %	0 %	0 %
11:00		-1°	0 mm	Gentle breeze, 5 m/s from south	1012 hPa	70 %	-6°	0 %	0 %	0 %	0 %	0 %
12:00		0°	0 mm	Moderate breeze, 6 m/s from south	1012 hPa	68 %	-6°	0 %	0 %	0 %	0 %	0 %
13:00		0°	0 mm	Moderate breeze, 6 m/s from south-southeast	1011 hPa	65 %	-6°	0 %	0 %	0 %	0 %	0 %
14:00		0°	0 mm	Moderate breeze, 6 m/s from south-southeast	1011 hPa	60 %	-7°	29 %	0 %	18 %	18 %	0 %
15:00		0°	0 mm	Moderate breeze, 7 m/s from south-southeast	1010 hPa	57 %	-7°	83 %	0 %	81 %	36 %	0 %
16:00		1°	0-0.2 mm	Fresh breeze, 8 m/s from south-southeast	1010 hPa	58 %	-7°	90 %	1 %	90 %	50 %	0 %
17:00		1°	0-0.1 mm	Fresh breeze, 8 m/s from south	1010 hPa	70 %	-4°	53 %	0 %	52 %	3 %	0 %
18:00		1°	0 mm	Fresh breeze, 8 m/s from south	1009 hPa	77 %	-3°	30 %	0 %	20 %	9 %	6 %
19:00		1°	0 mm	Fresh breeze, 9 m/s from south	1008 hPa	76 %	-3°	5 %	0 %	0 %	0 %	5 %
20:00		0°	0 mm	Fresh breeze, 9 m/s from south-southeast	1007 hPa	72 %	-4°	12 %	0 %	0 %	0 %	12 %
21:00		0°	0 mm	Fresh breeze, 9 m/s from south-southeast	1006 hPa	70 %	-4°	45 %	0 %	0 %	0 %	45 %
22:00		0°	0 mm	Fresh breeze, 9 m/s from south-southeast	1005 hPa	68 %	-5°	57 %	0 %	0 %	0 %	57 %
23:00		0°	0 mm	Fresh breeze, 9 m/s from south-southeast	1004 hPa	66 %	-6°	87 %	0 %	0 %	22 %	86 %

### Detailed forecast March 20, 2019

Time	Weather	Temp.	Precipitation	Wind	Pressure	Humidity	Dew point	Cloud cover				
								Total	Fog	Low clouds	Middle clouds	High clouds
00:00		0°	0 mm	Fresh breeze, 10 m/s from south-southeast	1002 hPa	63 %	-6°	100 %	0 %	3 %	83 %	100 %
01:00		1°	0 mm	Fresh breeze, 10 m/s from south-southeast	1001 hPa	59 %	-6°	100 %	0 %	6 %	93 %	100 %
02:00		1°	0 mm	Fresh breeze, 10 m/s from south-southeast	999 hPa	57 %	-6°	100 %	0 %	10 %	97 %	100 %
03:00		1°	0 mm	Fresh breeze, 10 m/s from south-southeast	998 hPa	56 %	-7°	100 %	0 %	21 %	99 %	100 %
04:00		1°	0 mm	Fresh breeze, 10 m/s from south-southeast	997 hPa	54 %	-7°	100 %	0 %	49 %	98 %	100 %
05:00		1°	0.1–0.2 mm	Strong breeze, 11 m/s from south	996 hPa	57 %	-7°	100 %	1 %	69 %	100 %	99 %
06:00		1°	0.1–0.2 mm	Strong breeze, 11 m/s from south-southeast	996 hPa	64 %	-5°	100 %	1 %	75 %	99 %	95 %
07:00		1°	0.1–0.2 mm	Strong breeze, 11 m/s from south-southeast	996 hPa	70 %	-4°	100 %	1 %	78 %	99 %	94 %
08:00		1°	0–0.2 mm	Strong breeze, 12 m/s from south	996 hPa	74 %	-3°	100 %	0 %	75 %	95 %	99 %
09:00		2°	0–0.1 mm	Fresh breeze, 10 m/s from south	996 hPa	77 %	-2°	100 %	0 %	85 %	82 %	97 %
10:00		2°	0 mm	Fresh breeze, 9 m/s from south	997 hPa	76 %	-1°	97 %	0 %	75 %	44 %	67 %

### Detailed forecast April 1, 2019

Time	Weather	Temp.	Precipitation	Wind	Pressure	Humidity	Dew point	Cloud cover				
								Total	Fog	Low clouds	Middle clouds	High clouds
12:00		1°	0 mm	Moderate breeze, 7 m/s from southwest	1005 hPa	88 %	-1°	57 %	0 %	55 %	2 %	1 %
13:00		1°	0 mm	Moderate breeze, 7 m/s from southwest	1005 hPa	87 %	-1°	67 %	0 %	66 %	2 %	0 %
14:00		1°	0–0.1 mm	Moderate breeze, 6 m/s from southwest	1005 hPa	85 %	-1°	90 %	0 %	82 %	33 %	18 %
15:00		1°	0.1–0.3 mm	Moderate breeze, 7 m/s from southwest	1006 hPa	89 %	0°	100 %	1 %	96 %	73 %	68 %
16:00		1°	0.1–1.4 mm	Moderate breeze, 7 m/s from southwest	1006 hPa	92 %	0°	100 %	1 %	93 %	81 %	76 %
17:00		0°	0.7–2.3 mm	Fresh breeze, 8 m/s from southwest	1006 hPa	87 %	-2°	96 %	1 %	82 %	67 %	82 %
18:00		0°	0–1.3 mm	Light breeze, 3 m/s from east-northeast	1007 hPa	92 %	-1°	95 %	0 %	28 %	44 %	89 %
19:00		-1°	0 mm	Light breeze, 2 m/s from east-southeast	1007 hPa	86 %	-3°	98 %	0 %	6 %	75 %	94 %
20:00		-1°	0 mm	Light breeze, 3 m/s from southeast	1007 hPa	84 %	-4°	99 %	0 %	8 %	75 %	95 %
21:00		-1°	0 mm	Light breeze, 3 m/s from southeast	1008 hPa	82 %	-4°	67 %	0 %	5 %	33 %	48 %
22:00		-2°	0 mm	Gentle breeze, 4 m/s from southeast	1008 hPa	86 %	-4°	77 %	0 %	8 %	33 %	66 %
23:00		-3°	0 mm	Gentle breeze, 4 m/s from south	1008 hPa	86 %	-6°	95 %	0 %	76 %	84 %	41 %



Detailed forecast April 2, 2019

Time	Weather	Temp.	Precipitation	Wind	Pressure	Humidity %	Dew point	Cloud cover				
								Total	Fog	Low clouds	Middle clouds	High clouds
00:00		-2°	0–0,1 mm	Gentle breeze, 4 m/s from south	1008 hPa	85 %	-5°	100 %	1 %	99 %	92 %	71 %
01:00		-2°	0,2–0,3 mm	Gentle breeze, 4 m/s from south	1008 hPa	83 %	-5°	100 %	1 %	95 %	95 %	100 %
02:00		-1°	0,2–0,3 mm	Gentle breeze, 4 m/s from south	1008 hPa	87 %	-3°	100 %	1 %	89 %	96 %	100 %
03:00		-1°	0,1–0,4 mm	Gentle breeze, 4 m/s from south-southeast	1008 hPa	87 %	-3°	100 %	1 %	98 %	94 %	100 %
04:00		0°	0,1–0,2 mm	Gentle breeze, 5 m/s from south	1007 hPa	85 %	-2°	100 %	1 %	94 %	100 %	100 %
05:00		1°	0,6–1,2 mm	Moderate breeze, 7 m/s from south	1007 hPa	86 %	-1°	100 %	1 %	100 %	100 %	100 %
06:00		1°	0,7–1,3 mm	Moderate breeze, 6 m/s from south	1006 hPa	89 %	0°	100 %	0 %	99 %	100 %	100 %
07:00		2°	0,5–1,1 mm	Fresh breeze, 8 m/s from south	1006 hPa	91 %	0°	100 %	1 %	97 %	100 %	100 %
08:00		2°	0,6–1,3 mm	Moderate breeze, 7 m/s from south	1006 hPa	91 %	1°	100 %	1 %	97 %	100 %	100 %
09:00		2°	0,9–1,3 mm	Moderate breeze, 7 m/s from south-southwest	1007 hPa	92 %	1°	100 %	0 %	98 %	98 %	100 %
10:00		2°	0,5–1,0 mm	Moderate breeze, 7 m/s from south-southwest	1007 hPa	91 %	1°	100 %	1 %	98 %	97 %	100 %
11:00		2°	0,5–0,9 mm	Fresh breeze, 9 m/s from south-southwest	1007 hPa	93 %	1°	100 %	0 %	97 %	96 %	100 %
12:00		3°	0,2–0,5 mm	Fresh breeze, 9 m/s from south-southwest	1007 hPa	92 %	1°	100 %	0 %	85 %	92 %	100 %
13:00		3°	0,1–0,3 mm	Fresh breeze, 9 m/s from south-southwest	1007 hPa	91 %	1°	100 %	0 %	88 %	92 %	100 %
14:00		3°	0,1–0,3 mm	Fresh breeze, 9 m/s from south-southwest	1007 hPa	90 %	1°	100 %	0 %	94 %	96 %	100 %
15:00		2°	0,4–0,8 mm	Fresh breeze, 9 m/s from south-southwest	1008 hPa	90 %	1°	100 %	1 %	97 %	100 %	96 %
16:00		2°	0,5–1,3 mm	Fresh breeze, 8 m/s from south-southwest	1008 hPa	90 %	1°	100 %	1 %	95 %	99 %	98 %
17:00		2°	0,3–0,8 mm	Moderate breeze, 7 m/s from south-southwest	1008 hPa	90 %	1°	100 %	0 %	89 %	99 %	98 %
18:00		2°	0,1–0,4 mm	Fresh breeze, 8 m/s from south-southwest	1008 hPa	88 %	0°	100 %	0 %	75 %	99 %	98 %
19:00		2°	0,1–0,2 mm	Moderate breeze, 7 m/s from south-southwest	1008 hPa	86 %	0°	100 %	0 %	63 %	95 %	100 %
20:00		2°	0–0,1 mm	Moderate breeze, 7 m/s from south	1008 hPa	85 %	0°	100 %	0 %	75 %	91 %	100 %
21:00		2°	0,1–0,3 mm	Moderate breeze, 7 m/s from south	1008 hPa	83 %	-1°	100 %	1 %	81 %	90 %	100 %
22:00		2°	0,1–0,2 mm	Moderate breeze, 7 m/s from south	1008 hPa	81 %	-1°	100 %	0 %	60 %	82 %	100 %
23:00		2°	0–0,1 mm	Moderate breeze, 7 m/s from south	1008 hPa	80 %	-1°	100 %	0 %	42 %	77 %	99 %

### Detailed forecast April 3, 2019

Time	Weather	Temp.	Precipitation	Wind	Pressure	Humidity	Dew point	Cloud cover				
								Total	Fog	Low clouds	Middle clouds	High clouds
00:00		2°	0 mm	Moderate breeze, 6 m/s from south	1008 hPa	77 %	-2°	92 %	0 %	17 %	48 %	81 %
01:00		1°	0 mm	Moderate breeze, 6 m/s from south	1008 hPa	74 %	-3°	78 %	0 %	5 %	24 %	70 %
02:00		1°	0 mm	Moderate breeze, 6 m/s from south	1008 hPa	73 %	-4°	52 %	0 %	1 %	8 %	47 %
03:00		0°	0 mm	Moderate breeze, 6 m/s from south	1008 hPa	72 %	-4°	76 %	0 %	0 %	1 %	75 %
04:00		0°	0 mm	Gentle breeze, 5 m/s from south-southeast	1008 hPa	71 %	-4°	70 %	0 %	0 %	0 %	70 %
05:00		0°	0 mm	Gentle breeze, 5 m/s from south-southeast	1008 hPa	71 %	-4°	100 %	0 %	0 %	14 %	100 %
06:00		1°	0 mm	Gentle breeze, 5 m/s from south-southeast	1008 hPa	70 %	-4°	100 %	0 %	1 %	60 %	100 %
07:00		1°	0 mm	Gentle breeze, 5 m/s from south	1008 hPa	68 %	-4°	100 %	0 %	11 %	83 %	100 %
08:00		1°	0 mm	Gentle breeze, 4 m/s from south	1008 hPa	66 %	-5°	100 %	0 %	22 %	90 %	100 %
09:00		1°	0 mm	Gentle breeze, 4 m/s from south-southeast	1008 hPa	66 %	-4°	100 %	0 %	24 %	84 %	100 %
10:00		2°	0 mm	Gentle breeze, 4 m/s from south	1008 hPa	66 %	-4°	100 %	0 %	23 %	81 %	100 %

### Detailed forecast April 2, 2019

Time	Weather	Temp.	Precipitation	Wind	Pressure	Humidity	Dew point	Cloud cover				
								Total	Fog	Low clouds	Middle clouds	High clouds
15:00		2°	0,3 – 1,2 mm	Fresh breeze, 9 m/s from south-southwest	1008 hPa	93 %	1°	100 %	1 %	99 %	99 %	98 %
16:00		2°	0,6 – 1,4 mm	Moderate breeze, 7 m/s from south-southwest	1008 hPa	93 %	1°	100 %	1 %	99 %	100 %	100 %
17:00		2°	0,6 – 1,4 mm	Moderate breeze, 7 m/s from south-southwest	1008 hPa	94 %	1°	100 %	1 %	99 %	100 %	100 %
18:00		2°	0,7 – 1,5 mm	Fresh breeze, 8 m/s from south-southwest	1008 hPa	94 %	1°	100 %	1 %	98 %	100 %	100 %
19:00		2°	0,6 – 1,5 mm	Fresh breeze, 8 m/s from south-southwest	1008 hPa	94 %	1°	100 %	1 %	98 %	100 %	100 %
20:00		2°	0,4 – 1,1 mm	Fresh breeze, 8 m/s from south-southwest	1008 hPa	93 %	1°	100 %	1 %	92 %	99 %	100 %
21:00		2°	0,2 – 1,0 mm	Fresh breeze, 8 m/s from south-southwest	1009 hPa	92 %	1°	100 %	0 %	89 %	98 %	100 %
22:00		2°	0,1 – 0,3 mm	Moderate breeze, 7 m/s from south-southwest	1009 hPa	92 %	1°	100 %	0 %	82 %	97 %	100 %
23:00		3°	0,1 – 0,2 mm	Moderate breeze, 7 m/s from south-southwest	1009 hPa	90 %	1°	100 %	0 %	84 %	94 %	96 %

### Detailed forecast April 3, 2019

Time	Weather	Temp.	Precipitation	Wind	Pressure	Humidity	Dew point	Cloud cover				
								Total	Fog	Low clouds	Middle clouds	High clouds
00:00		3°	0,2 – 0,4 mm	Moderate breeze, 7 m/s from south-southwest	1010 hPa	89 %	1°	100 %	0 %	91 %	91 %	74 %

Time	Weather	Temp.	Precipitation	Wind	Pressure	Humidity	Dew point	Cloud cover				
								Total	Fog	Low clouds	Middle clouds	High clouds
01:00		3°	0,1 – 0,3 mm	Moderate breeze, 7 m/s from southwest	1010 hPa	88 %	1°	96 %	0 %	83 %	62 %	2 %
02:00		3°	0,1 – 0,2 mm	Fresh breeze, 8 m/s from south	1010 hPa	87 %	1°	96 %	0 %	90 %	78 %	0 %
03:00		2°	0 – 0,2 mm	Fresh breeze, 8 m/s from south	1010 hPa	87 %	1°	94 %	0 %	89 %	40 %	8 %
04:00		2°	0 – 0,1 mm	Fresh breeze, 8 m/s from southwest	1010 hPa	86 %	0°	85 %	0 %	63 %	35 %	21 %
05:00		2°	0 mm	Moderate breeze, 7 m/s from south	1010 hPa	84 %	0°	78 %	0 %	36 %	41 %	38 %
06:00		2°	0 mm	Moderate breeze, 7 m/s from south	1009 hPa	82 %	-1°	96 %	0 %	8 %	13 %	95 %
07:00		2°	0 mm	Moderate breeze, 7 m/s from south	1009 hPa	80 %	-1°	100 %	0 %	2 %	22 %	100 %
08:00		2°	0 mm	Moderate breeze, 7 m/s from south	1009 hPa	79 %	-1°	100 %	0 %	2 %	81 %	100 %
09:00		2°	0 mm	Moderate breeze, 7 m/s from south	1009 hPa	76 %	-2°	100 %	0 %	8 %	91 %	100 %
10:00		3°	0 mm	Moderate breeze, 6 m/s from south	1009 hPa	73 %	-2°	100 %	0 %	8 %	84 %	100 %
11:00		3°	0 mm	Moderate breeze, 6 m/s from south	1009 hPa	69 %	-2°	100 %	0 %	11 %	82 %	99 %
12:00		3°	0 mm	Gentle breeze, 5 m/s from south	1009 hPa	66 %	-3°	100 %	0 %	21 %	93 %	100 %
13:00		4°	0 mm	Gentle breeze, 4 m/s from south	1009 hPa	67 %	-2°	100 %	0 %	44 %	98 %	100 %
14:00		3°	0 – 0,1 mm	Gentle breeze, 4 m/s from southwest	1008 hPa	68 %	-2°	100 %	0 %	79 %	99 %	100 %
15:00		2°	0,2 – 0,3 mm	Light breeze, 3 m/s from southwest	1008 hPa	75 %	-1°	100 %	1 %	98 %	100 %	99 %
16:00		2°	0,2 – 0,4 mm	Gentle breeze, 4 m/s from south	1008 hPa	84 %	-1°	100 %	1 %	100 %	100 %	100 %
17:00		2°	0,3 – 0,6 mm	Gentle breeze, 4 m/s from southwest	1008 hPa	89 %	0°	100 %	1 %	100 %	100 %	100 %
18:00		2°	0,3 – 0,6 mm	Gentle breeze, 4 m/s from southwest	1007 hPa	89 %	0°	100 %	2 %	100 %	100 %	100 %
19:00		1°	0,3 – 0,7 mm	Light breeze, 3 m/s from south	1007 hPa	90 %	0°	100 %	1 %	99 %	100 %	99 %
20:00		1°	0,4 – 1,4 mm	Light breeze, 2 m/s from southwest	1007 hPa	91 %	0°	100 %	4 %	100 %	100 %	94 %
21:00		0°	0,5 – 1,1 mm	Moderate breeze, 6 m/s from northeast	1008 hPa	94 %	0°	100 %	2 %	100 %	100 %	54 %
22:00		0°	0,3 – 0,6 mm	Fresh breeze, 8 m/s from northeast	1009 hPa	91 %	-1°	100 %	2 %	100 %	100 %	62 %
23:00		-1°	0,3 – 0,6 mm	Fresh breeze, 8 m/s from northeast	1009 hPa	89 %	-2°	100 %	2 %	100 %	100 %	83 %

#### Detailed forecast April 4, 2019

Time	Weather	Temp.	Precipitation	Wind	Pressure	Humidity	Dew point	Cloud cover				
								Total	Fog	Low clouds	Middle clouds	High clouds

Time	Weather	Temp.	Precipitation	Wind	Pressure	Humidity	Dew point	Cloud cover				
								Total	Fog	Low clouds	Middle clouds	High clouds
00:00		-1°	0,2—0,6 mm	Fresh breeze, 8 m/s from north-northeast	1010 hPa	91 %	-2°	100 %	2 %	100 %	100 %	89 %
01:00		-1°	0,2—0,5 mm	Fresh breeze, 8 m/s from north-northeast	1010 hPa	89 %	-3°	100 %	2 %	98 %	100 %	14 %
02:00		-1°	0,1—0,4 mm	Moderate breeze, 7 m/s from north-northeast	1011 hPa	90 %	-3°	99 %	2 %	93 %	91 %	0 %
03:00		-2°	0—0,2 mm	Moderate breeze, 6 m/s from north-northeast	1011 hPa	92 %	-3°	86 %	0 %	74 %	55 %	0 %
04:00		-2°	0—0,1 mm	Gentle breeze, 5 m/s from north-northeast	1012 hPa	85 %	-4°	62 %	0 %	48 %	28 %	0 %
05:00		-2°	0 mm	Gentle breeze, 4 m/s from north-northeast	1013 hPa	88 %	-4°	42 %	0 %	31 %	15 %	0 %
06:00		-3°	0 mm	Light breeze, 3 m/s from north-northeast	1013 hPa	89 %	-4°	21 %	0 %	19 %	0 %	0 %
07:00		-3°	0 mm	Light breeze, 3 m/s from east-northeast	1014 hPa	89 %	-5°	7 %	0 %	7 %	0 %	0 %
08:00		-3°	0 mm	Light breeze, 3 m/s from east	1015 hPa	84 %	-5°	38 %	0 %	35 %	7 %	0 %
09:00		-2°	0 mm	Light breeze, 2 m/s from east-northeast	1016 hPa	80 %	-6°	30 %	0 %	28 %	7 %	0 %
10:00		-2°	0 mm	Light breeze, 2 m/s from east	1017 hPa	79 %	-5°	38 %	0 %	37 %	1 %	0 %
11:00		0°	0 mm	Light breeze, 3 m/s from north-northeast	1017 hPa	85 %	-3°	45 %	0 %	44 %	12 %	0 %
12:00		0°	0—0,1 mm	Light breeze, 3 m/s from north	1018 hPa	79 %	-3°	38 %	0 %	37 %	2 %	0 %
13:00		0°	0—0,1 mm	Gentle breeze, 4 m/s from north-northeast	1019 hPa	79 %	-3°	51 %	0 %	47 %	16 %	0 %

Detailed forecast April 4, 2019

Time	Weather	Temp.	Precipitation	Wind	Pressure	Humidity	Dew point	Cloud cover				
								Total	Fog	Low clouds	Middle clouds	High clouds
15:00		1°	0 mm	Light breeze, 2 m/s from northeast	1021 hPa	88 %	-1°	26 %	0 %	25 %	0 %	0 %
16:00		1°	0 mm	Light breeze, 2 m/s from northeast	1021 hPa	84 %	-1°	30 %	0 %	18 %	0 %	14 %
17:00		1°	0 mm	Light breeze, 2 m/s from east	1022 hPa	84 %	-1°	45 %	0 %	13 %	0 %	37 %
18:00		0°	0 mm	Light breeze, 3 m/s from east-southeast	1023 hPa	79 %	-3°	42 %	0 %	8 %	0 %	37 %
19:00		-1°	0 mm	Light breeze, 3 m/s from east	1023 hPa	81 %	-4°	57 %	0 %	4 %	0 %	55 %
20:00		-2°	0 mm	Gentle breeze, 4 m/s from east-southeast	1024 hPa	80 %	-5°	59 %	0 %	2 %	0 %	58 %
21:00		-3°	0 mm	Gentle breeze, 4 m/s from east-southeast	1024 hPa	79 %	-6°	76 %	0 %	2 %	0 %	76 %
22:00		-3°	0 mm	Light breeze, 3 m/s from east-southeast	1025 hPa	75 %	-7°	83 %	0 %	2 %	0 %	83 %
23:00		-3°	0 mm	Light breeze, 3 m/s from east-southeast	1025 hPa	77 %	-7°	69 %	0 %	2 %	0 %	68 %

Detailed forecast April 5, 2019

Time	Weather	Temp.	Precipitation	Wind	Pressure	Humidity	Dew point	Cloud cover				
								Total	Fog	Low clouds	Middle clouds	High clouds
00:00		-3°	0 mm	Light breeze, 3 m/s from east-southeast	1026 hPa	77 %	-7°	21 %	0 %	1 %	1 %	20 %
01:00		-3°	0 mm	Light breeze, 3 m/s from southeast	1027 hPa	71 %	-8°	0 %	0 %	0 %	0 %	0 %
02:00		-4°	0 mm	Light breeze, 3 m/s from south-southeast	1027 hPa	71 %	-8°	0 %	0 %	0 %	0 %	0 %

















Time	Weather	Temp.	Precipitation	Wind	Pressure	Humidity	Dew point	Cloud cover				
								Total	Fog	Low clouds	Middle clouds	High clouds
03:00		-4°	0 mm	Light breeze, 3 m/s from south-southeast	1028 hPa	71 %	-8°	6 %	0 %	0 %	0 %	6 %
04:00		-4°	0 mm	Light breeze, 3 m/s from south-southeast	1028 hPa	68 %	-8°	78 %	0 %	0 %	0 %	78 %
05:00		-4°	0 mm	Light breeze, 3 m/s from south-southeast	1028 hPa	66 %	-8°	82 %	0 %	0 %	0 %	82 %
06:00		-4°	0 mm	Light breeze, 3 m/s from south-southeast	1028 hPa	64 %	-8°	70 %	0 %	0 %	0 %	70 %
07:00		-3°	0 mm	Light breeze, 3 m/s from south-southeast	1028 hPa	63 %	-8°	17 %	0 %	0 %	0 %	17 %
08:00		-3°	0 mm	Light breeze, 3 m/s from south	1028 hPa	62 %	-8°	25 %	0 %	0 %	0 %	25 %
09:00		-2°	0 mm	Light breeze, 2 m/s from south	1028 hPa	61 %	-8°	45 %	0 %	0 %	0 %	45 %
10:00		0°	0 mm	Light breeze, 3 m/s from south-southeast	1028 hPa	58 %	-7°	4 %	0 %	0 %	0 %	4 %
11:00		1°	0 mm	Gentle breeze, 5 m/s from south	1028 hPa	57 %	-6°	0 %	0 %	0 %	0 %	0 %
12:00		2°	0 mm	Gentle breeze, 5 m/s from south	1028 hPa	58 %	-6°	0 %	0 %	0 %	0 %	0 %
13:00		2°	0 mm	Gentle breeze, 4 m/s from south	1027 hPa	58 %	-6°	0 %	0 %	0 %	0 %	0 %
14:00		3°	0 mm	Gentle breeze, 5 m/s from south	1027 hPa	58 %	-6°	0 %	0 %	0 %	0 %	0 %
15:00		3°	0 mm	Gentle breeze, 5 m/s from south	1027 hPa	58 %	-6°	1 %	0 %	0 %	0 %	1 %
16:00		2°	0 mm	Moderate breeze, 6 m/s from south	1026 hPa	57 %	-6°	2 %	0 %	0 %	0 %	2 %
17:00		2°	0 mm	Moderate breeze, 6 m/s from south	1026 hPa	56 %	-6°	0 %	0 %	0 %	0 %	0 %
18:00		2°	0 mm	Gentle breeze, 5 m/s from south-southeast	1025 hPa	57 %	-6°	0 %	0 %	0 %	0 %	0 %
19:00		1°	0 mm	Gentle breeze, 5 m/s from south-southeast	1025 hPa	58 %	-6°	0 %	0 %	0 %	0 %	0 %
20:00		0°	0 mm	Gentle breeze, 5 m/s from south-southeast	1024 hPa	58 %	-7°	0 %	0 %	0 %	0 %	0 %
21:00		-1°	0 mm	Gentle breeze, 5 m/s from south-southeast	1024 hPa	58 %	-8°	0 %	0 %	0 %	0 %	0 %
22:00		-1°	0 mm	Moderate breeze, 6 m/s from south-southeast	1024 hPa	56 %	-8°	0 %	0 %	0 %	0 %	0 %
23:00		-1°	0 mm	Moderate breeze, 6 m/s from south-southeast	1023 hPa	55 %	-8°	0 %	0 %	0 %	0 %	0 %

#### Detailed forecast April 6, 2019









Time	Weather	Temp.	Precipitation	Wind	Pressure	Humidity	Dew point	Cloud cover				
								Total	Fog	Low clouds	Middle clouds	High clouds
00:00		0°	0 mm	Moderate breeze, 6 m/s from south	1023 hPa	56 %	-8°	0 %	0 %	0 %	0 %	0 %
01:00		0°	0 mm	Moderate breeze, 6 m/s from south	1023 hPa	56 %	-8°	0 %	0 %	0 %	0 %	0 %

Time	Weather	Temp.	Precipitation	Wind	Pressure	Humidity	Dew point	Cloud cover					
								Total	Fog	Low clouds	Middle clouds	High clouds	
02:00		-1°	0 mm	Moderate breeze, 6 m/s from south	1023 hPa	57 %	-8°	0 %	0 %	0 %	0 %	0 %	0 %
03:00		0°	0 mm	Moderate breeze, 6 m/s from south	1022 hPa	58 %	-8°	0 %	0 %	0 %	0 %	0 %	0 %
04:00		0°	0 mm	Moderate breeze, 6 m/s from south	1022 hPa	57 %	-8°	0 %	0 %	0 %	0 %	0 %	0 %
05:00		0°	0 mm	Moderate breeze, 6 m/s from south	1022 hPa	58 %	-8°	0 %	0 %	0 %	0 %	0 %	0 %
06:00		0°	0 mm	Moderate breeze, 6 m/s from south	1022 hPa	59 %	-7°	2 %	0 %	2 %	0 %	0 %	0 %
07:00		0°	0 mm	Moderate breeze, 7 m/s from south	1022 hPa	62 %	-6°	9 %	0 %	9 %	0 %	0 %	0 %
08:00		0°	0 mm	Moderate breeze, 6 m/s from south	1022 hPa	65 %	-6°	32 %	0 %	32 %	0 %	0 %	0 %
09:00		1°	0 mm	Moderate breeze, 6 m/s from southwest	1022 hPa	68 %	-4°	47 %	0 %	47 %	0 %	0 %	0 %
10:00		2°	0 mm	Moderate breeze, 6 m/s from southwest	1022 hPa	70 %	-3°	59 %	0 %	58 %	0 %	0 %	0 %
11:00		2°	0 mm	Gentle breeze, 5 m/s from southwest	1022 hPa	71 %	-2°	76 %	0 %	76 %	1 %	0 %	0 %
12:00		3°	0 – 0,4 mm	Moderate breeze, 6 m/s from southwest	1022 hPa	72 %	-2°	89 %	0 %	89 %	8 %	0 %	0 %
13:00		3°	0 – 0,4 mm	Gentle breeze, 5 m/s from southwest	1022 hPa	72 %	-1°	99 %	1 %	99 %	24 %	0 %	0 %

Detailed forecast April 8, 2019

Time	Weather	Temp.	Precipitation	Wind	Pressure	Humidity	Dew point	Cloud cover				
								Total	Fog	Low clouds	Middle clouds	High clouds
16:00		1°	0 mm	 Light breeze, 3 m/s from east	1029 hPa	71 %	-4°	0 %	0 %	0 %	0 %	0 %
17:00		0°	0 mm	 Light breeze, 3 m/s from east	1029 hPa	70 %	-5°	0 %	0 %	0 %	0 %	0 %
18:00		-1°	0 mm	 Gentle breeze, 4 m/s from east	1029 hPa	76 %	-4°	4 %	0 %	3 %	0 %	0 %
19:00		-2°	0 mm	 Gentle breeze, 4 m/s from east	1029 hPa	76 %	-5°	3 %	0 %	3 %	0 %	0 %
20:00		-2°	0 mm	 Gentle breeze, 4 m/s from east	1029 hPa	78 %	-6°	2 %	0 %	2 %	0 %	0 %
21:00		-3°	0 mm	 Gentle breeze, 4 m/s from east	1030 hPa	78 %	-6°	0 %	0 %	0 %	0 %	0 %
22:00		-4°	0 mm	 Gentle breeze, 4 m/s from east	1030 hPa	78 %	-7°	1 %	0 %	0 %	0 %	0 %
23:00		-4°	0 mm	 Gentle breeze, 4 m/s from east-southeast	1030 hPa	77 %	-8°	1 %	0 %	1 %	0 %	0 %

Detailed forecast April 9, 2019

























Time	Weather	Temp.	Precipitation	Wind	Pressure	Humidity	Dew point	Cloud cover				
								Total	Fog	Low clouds	Middle clouds	High clouds
00:00		-4°	0 mm	 Gentle breeze, 4 m/s from east-southeast	1031 hPa	74 %	-8°	1 %	0 %	0 %	0 %	0 %
01:00		-5°	0 mm	 Gentle breeze, 4 m/s from east-southeast	1031 hPa	75 %	-8°	0 %	0 %	0 %	0 %	0 %
02:00		-5°	0 mm	 Gentle breeze, 4 m/s from east-southeast	1031 hPa	75 %	-8°	0 %	0 %	0 %	0 %	0 %
03:00		-5°	0 mm	 Gentle breeze, 4 m/s from east	1031 hPa	73 %	-8°	0 %	0 %	0 %	0 %	0 %



Time	Weather	Temp.	Precipitation	Wind	Pressure	Humidity	Dew point	Cloud cover				
								Total	Fog	Low clouds	Middle clouds	High clouds
04:00		-5°	0 mm	Gentle breeze, 4 m/s from east	1032 hPa	72 %	-10°	0 %	0 %	0 %	0 %	0 %
05:00		-6°	0 mm	Light breeze, 3 m/s from east	1032 hPa	71 %	-10°	0 %	0 %	0 %	0 %	0 %
06:00		-6°	0 mm	Light breeze, 3 m/s from east	1032 hPa	71 %	-10°	0 %	0 %	0 %	0 %	0 %
07:00		-5°	0 mm	Light breeze, 3 m/s from east	1032 hPa	71 %	-10°	0 %	0 %	0 %	0 %	0 %
08:00		-5°	0 mm	Light breeze, 3 m/s from east	1033 hPa	70 %	-9°	0 %	0 %	0 %	0 %	0 %
09:00		-4°	0 mm	Light breeze, 2 m/s from east-northeast	1033 hPa	72 %	-8°	0 %	0 %	0 %	0 %	0 %
10:00		-3°	0 mm	Light air, 1 m/s from northeast	1033 hPa	73 %	-7°	0 %	0 %	0 %	0 %	0 %
11:00		-2°	0 mm	Light breeze, 2 m/s from east	1033 hPa	64 %	-7°	0 %	0 %	0 %	0 %	0 %
12:00		-1°	0 mm	Light breeze, 2 m/s from east	1033 hPa	66 %	-7°	0 %	0 %	0 %	0 %	0 %
13:00		-1°	0 mm	Light breeze, 3 m/s from east	1033 hPa	65 %	-7°	0 %	0 %	0 %	0 %	0 %
14:00		0°	0 mm	Light breeze, 2 m/s from east	1033 hPa	65 %	-6°	0 %	0 %	0 %	0 %	0 %
15:00		0°	0 mm	Light breeze, 2 m/s from east	1034 hPa	66 %	-6°	0 %	0 %	0 %	0 %	0 %
16:00		-1°	0 mm	Light breeze, 2 m/s from east	1033 hPa	66 %	-6°	0 %	0 %	0 %	0 %	0 %
17:00		-1°	0 mm	Light breeze, 3 m/s from east	1033 hPa	68 %	-7°	0 %	0 %	0 %	0 %	0 %
18:00		-2°	0 mm	Gentle breeze, 4 m/s from east	1034 hPa	71 %	-7°	0 %	0 %	0 %	0 %	0 %
19:00		-3°	0 mm	Gentle breeze, 4 m/s from east	1033 hPa	71 %	-7°	0 %	0 %	0 %	0 %	0 %
20:00		-4°	0 mm	Gentle breeze, 4 m/s from east-southeast	1033 hPa	70 %	-8°	0 %	0 %	0 %	0 %	0 %
21:00		-4°	0 mm	Gentle breeze, 4 m/s from east-southeast	1033 hPa	69 %	-8°	0 %	0 %	0 %	0 %	0 %
22:00		-5°	0 mm	Gentle breeze, 4 m/s from east-southeast	1033 hPa	69 %	-10°	0 %	0 %	0 %	0 %	0 %
23:00		-5°	0 mm	Light breeze, 3 m/s from east-southeast	1034 hPa	66 %	-11°	0 %	0 %	0 %	0 %	0 %

#### Detailed forecast April 10, 2019

Time	Weather	Temp.	Precipitation	Wind	Pressure	Humidity	Dew point	Cloud cover				
								Total	Fog	Low clouds	Middle clouds	High clouds
00:00		-6°	0 mm	Gentle breeze, 4 m/s from southeast	1034 hPa	66 %	-11°	0 %	0 %	0 %	0 %	0 %
01:00		-6°	0 mm	Gentle breeze, 4 m/s from southeast	1034 hPa	63 %	-11°	0 %	0 %	0 %	0 %	0 %
02:00		-6°	0 mm	Light breeze, 3 m/s from southeast	1034 hPa	62 %	-12°	0 %	0 %	0 %	0 %	0 %

Time	Weather	Temp.	Precipitation	Wind	Pressure	Humidity	Dew point	Cloud cover				
								Total	Fog	Low clouds	Middle clouds	High clouds
03:00		-6°	0 mm	 Gentle breeze, 4 m/s from southeast	1034 hPa	62 %	-12°	0 %	0 %	0 %	0 %	0 %
04:00		-6°	0 mm	 Light breeze, 3 m/s from southeast	1034 hPa	64 %	-12°	0 %	0 %	0 %	0 %	0 %
05:00		-6°	0 mm	 Light breeze, 3 m/s from southeast	1034 hPa	64 %	-12°	0 %	0 %	0 %	0 %	0 %
06:00		-6°	0 mm	 Light breeze, 3 m/s from southeast	1034 hPa	63 %	-12°	0 %	0 %	0 %	0 %	0 %
07:00		-6°	0 mm	 Light breeze, 3 m/s from southeast	1033 hPa	62 %	-12°	0 %	0 %	0 %	0 %	0 %
08:00		-5°	0 mm	 Light breeze, 2 m/s from southeast	1033 hPa	59 %	-12°	0 %	0 %	0 %	0 %	0 %
09:00		-4°	0 mm	 Light air, 1 m/s from southeast	1033 hPa	58 %	-11°	0 %	0 %	0 %	0 %	0 %
10:00		-3°	0 mm	 Light air, 1 m/s from southwest	1033 hPa	60 %	-10°	0 %	0 %	0 %	0 %	0 %
11:00		-2°	0 mm	 Light air, 1 m/s from southwest	1033 hPa	63 %	-8°	1 %	0 %	0 %	0 %	1 %
12:00		-2°	0 mm	 Light air, 1 m/s from southwest	1033 hPa	59 %	-8°	0 %	0 %	0 %	0 %	0 %
13:00		-1°	0 mm	 Light air, 1 m/s from southwest	1033 hPa	56 %	-8°	0 %	0 %	0 %	0 %	0 %
14:00		-1°	0 mm	 Light air, 1 m/s from southwest	1033 hPa	55 %	-8°	0 %	0 %	0 %	0 %	0 %

Detailed forecast April 16, 2019

Time	Weather	Temp.	Precipitation	Wind	Pressure	Humidity	Dew point	Cloud cover				
								Total	Fog	Low clouds	Middle clouds	High clouds
14:00		5°	0 mm	Light air, 1 m/s from south-southeast	1036 hPa	77 %	1°	99 %	0 %	2 %	1 %	99 %
15:00		5°	0 mm	Light air, 1 m/s from south-southwest	1036 hPa	72 %	0°	100 %	0 %	1 %	0 %	100 %
16:00		5°	0 mm	Light air, 1 m/s from south-southeast	1036 hPa	73 %	0°	80 %	0 %	0 %	0 %	80 %
17:00		4°	0 mm	Light breeze, 2 m/s from southeast	1036 hPa	74 %	0°	94 %	0 %	0 %	0 %	94 %
18:00		4°	0 mm	Light breeze, 2 m/s from southeast	1036 hPa	77 %	0°	70 %	0 %	0 %	0 %	69 %
19:00		3°	0 mm	Light breeze, 3 m/s from southeast	1035 hPa	79 %	0°	87 %	0 %	1 %	0 %	87 %
20:00		2°	0 mm	Light breeze, 3 m/s from southeast	1035 hPa	79 %	-1°	95 %	0 %	2 %	0 %	95 %
21:00		2°	0 mm	Gentle breeze, 4 m/s from southeast	1036 hPa	78 %	-2°	92 %	0 %	8 %	0 %	92 %
22:00		2°	0 mm	Light breeze, 3 m/s from southeast	1036 hPa	78 %	-2°	90 %	0 %	11 %	0 %	88 %
23:00		1°	0 mm	Light breeze, 3 m/s from southeast	1036 hPa	78 %	-2°	100 %	0 %	1 %	0 %	100 %



























Detailed forecast April 17, 2019

Time	Weather	Temp.	Precipitation	Wind	Pressure	Humidity	Dew point	Cloud cover				
								Total	Fog	Low clouds	Middle clouds	High clouds
00:00		1°	0 mm	Light breeze, 3 m/s from southeast	1036 hPa	78 %	-3°	100 %	0 %	0 %	0 %	100 %
01:00		1°	0 mm	Light breeze, 3 m/s from southeast	1036 hPa	77 %	-3°	100 %	0 %	0 %	0 %	100 %

Time	Weather	Temp.	Precipitation	Wind	Pressure	Humidity	Dew point	Cloud cover				
								Total	Fog	Low clouds	Middle clouds	High clouds
02:00		1°	0 mm	Light breeze, 3 m/s from south-southeast	1036 hPa	74 %	-3°	100 %	0 %	0 %	0 %	100 %
03:00		1°	0 mm	Light breeze, 3 m/s from south-southeast	1036 hPa	72 %	-3°	100 %	0 %	0 %	2 %	100 %
04:00		1°	0 mm	Light breeze, 3 m/s from south-southeast	1036 hPa	73 %	-3°	100 %	0 %	0 %	8 %	100 %
05:00		1°	0 mm	Light breeze, 3 m/s from southeast	1036 hPa	72 %	-3°	100 %	0 %	0 %	11 %	100 %
06:00		1°	0 mm	Light breeze, 2 m/s from southeast	1036 hPa	70 %	-3°	100 %	0 %	0 %	11 %	100 %
07:00		2°	0 mm	Light breeze, 2 m/s from southeast	1035 hPa	68 %	-3°	99 %	0 %	0 %	8 %	99 %
08:00		2°	0 mm	Light air, 1 m/s from southeast	1036 hPa	69 %	-3°	100 %	0 %	0 %	11 %	100 %
09:00		3°	0 mm	Light air, 1 m/s from south	1035 hPa	70 %	-2°	100 %	0 %	0 %	12 %	100 %
10:00		4°	0 mm	Calm, 0 m/s from southwest	1036 hPa	73 %	-1°	100 %	0 %	0 %	5 %	100 %
11:00		5°	0 mm	Light air, 1 m/s from west-southwest	1036 hPa	74 %	0°	98 %	0 %	0 %	1 %	98 %
12:00		6°	0 mm	Light air, 1 m/s from west-southwest	1036 hPa	72 %	1°	99 %	0 %	0 %	0 %	99 %
13:00		6°	0 mm	Light air, 1 m/s from west	1036 hPa	67 %	0°	100 %	0 %	0 %	0 %	100 %
14:00		6°	0 mm	Light air, 1 m/s from north-northeast	1036 hPa	62 %	0°	100 %	0 %	0 %	0 %	100 %
15:00		6°	0 mm	Light air, 1 m/s from northeast	1036 hPa	65 %	0°	100 %	0 %	0 %	0 %	100 %
16:00		6°	0 mm	Light air, 1 m/s from northeast	1036 hPa	69 %	1°	99 %	0 %	0 %	0 %	99 %
17:00		6°	0 mm	Light air, 1 m/s from northeast	1036 hPa	72 %	1°	98 %	0 %	0 %	0 %	98 %
18:00		6°	0 mm	Light air, 1 m/s from east-northeast	1035 hPa	77 %	2°	99 %	0 %	0 %	0 %	99 %
19:00		5°	0 mm	Light air, 1 m/s from south-southeast	1035 hPa	71 %	0°	99 %	0 %	0 %	0 %	99 %
20:00		4°	0 mm	Light breeze, 3 m/s from south-southeast	1035 hPa	64 %	-2°	99 %	0 %	0 %	0 %	99 %
21:00		4°	0 mm	Light breeze, 3 m/s from south-southeast	1035 hPa	64 %	-3°	99 %	0 %	0 %	0 %	99 %
22:00		3°	0 mm	Light breeze, 3 m/s from south	1035 hPa	62 %	-3°	66 %	0 %	0 %	0 %	66 %
23:00		3°	0 mm	Light breeze, 3 m/s from south	1035 hPa	61 %	-4°	59 %	0 %	0 %	0 %	59 %























Detailed forecast April 18, 2019

Time	Weather	Temp.	Precipitation	Wind	Pressure	Humidity	Dew point	Cloud cover				
								Total	Fog	Low clouds	Middle clouds	High clouds

Time	Weather	Temp.	Precipitation	Wind	Pressure	Humidity	Dew point	Cloud cover				
								Total	Fog	Low clouds	Middle clouds	High clouds
00:00		3°	0 mm	 Gentle breeze, 4 m/s from south	1035 hPa	58 %	-4°	29 % ■	0 %	0 %	0 %	29 % ■
01:00		4°	0 mm	 Gentle breeze, 4 m/s from south	1035 hPa	56 %	-4°	69 % ■	0 %	0 %	0 %	69 % ■
02:00		4°	0 mm	 Gentle breeze, 5 m/s from south	1034 hPa	54 %	-4°	86 % ■	0 %	0 %	0 %	86 % ■
03:00		5°	0 mm	 Moderate breeze, 6 m/s from south	1034 hPa	54 %	-4°	89 % ■	0 %	0 %	0 %	89 % ■
04:00		5°	0 mm	 Moderate breeze, 6 m/s from south	1034 hPa	52 %	-4°	12 % ■	0 %	0 %	0 %	12 % ■
05:00		5°	0 mm	 Moderate breeze, 6 m/s from south	1034 hPa	52 %	-4°	0 %	0 %	0 %	0 %	0 %
06:00		6°	0 mm	 Gentle breeze, 5 m/s from south	1034 hPa	54 %	-3°	0 %	0 %	0 %	0 %	0 %
07:00		6°	0 mm	 Moderate breeze, 6 m/s from south	1033 hPa	57 %	-2°	0 %	0 %	0 %	0 %	0 %
08:00		7°	0 mm	 Moderate breeze, 6 m/s from south	1033 hPa	59 %	-1°	0 %	0 %	0 %	0 %	0 %
09:00		7°	0 mm	 Moderate breeze, 6 m/s from south > southwest	1033 hPa	59 %	0°	0 %	0 %	0 %	0 %	0 %
10:00		8°	0 mm	 Moderate breeze, 6 m/s from south > southwest	1033 hPa	60 %	0°	0 %	0 %	0 %	0 %	0 %
11:00		8°	0 mm	 Moderate breeze, 6 m/s from south > southwest	1033 hPa	62 %	1°	0 %	0 %	0 %	0 %	0 %
12:00		8°	0 mm	 Moderate breeze, 6 m/s from south > southwest	1033 hPa	66 %	2°	54 % ■	0 %	0 %	29 % ■	52 % ■











## Tromsø Weather History for 23 April 2019

Show weather for:

00:00 Tue, 23 Apr		7 °C	Light rain, Overcast.	20 km/h	/	88%	1007 mbar	11
01:00		6 °C	Light rain, Overcast.	13 km/h	↑	90%	1008 mbar	11
02:00		6 °C	Light rain, Low clouds.	11 km/h	/	92%	1008 mbar	8
03:00		6 °C	Light rain, Overcast.	9 km/h	↑	92%	1009 mbar	11
04:00		6 °C	Rain, Overcast.	7 km/h	/	92%	1009 mbar	9
05:00		6 °C	Light rain, Overcast.	4 km/h	\	94%	1010 mbar	8
06:00		6 °C	Light rain, Overcast.	4 km/h	/	94%	1011 mbar	6
07:00		6 °C	Rain, Overcast.	6 km/h	\	93%	1011 mbar	9
			Conditions				Comfort	-
<b>Time</b>		<b>Temp</b>	<b>Weather</b>	<b>Wind</b>		<b>Humidity</b>	<b>Barometer</b>	<b>V</b>
08:00		6 °C	Light rain, Low clouds.	11 km/h	/	92%	1012 mbar	0
10:00		6 °C	Light rain, Low clouds.	9 km/h	/	92%	1013 mbar	9
11:00		6 °C	Drizzle, Low clouds.	9 km/h	/	92%	1013 mbar	7
12:00		6 °C	Rain, Low clouds.	11 km/h	/	92%	1014 mbar	8
13:00		7 °C	Quite cool.	15 km/h	↑	92%	1014 mbar	N
14:00		6 °C	Overcast.	9 km/h	/	90%	1015 mbar	9
15:00		7 °C	Overcast.	11 km/h	/	82%	1015 mbar	11
16:00		7 °C	Overcast.	7 km/h	→	91%	1016 mbar	31
17:00		7 °C	Overcast.	9 km/h	→	89%	1016 mbar	11
18:00		7 °C	Overcast.	11 km/h	→	86%	1016 mbar	11
19:00		7 °C	Overcast.	11 km/h	\	87%	1017 mbar	11
20:00		6 °C	Overcast.	13 km/h	→	90%	1018 mbar	11

## Tromsø Weather History for 24 April 2019









Show weather for:

Time	Conditions		Comfort			
	Temp	Weather	Wind	Humidity	Barometer	V
00:00 Wed, 24 Apr	6 °C	 Quite cool.	2 km/h	\ 92%	1020 mbar	N
01:00	5 °C	 Quite cool.	2 km/h	\ 92%	1020 mbar	N
02:00	5 °C	 Quite cool.	2 km/h	↑ 93%	1021 mbar	N
03:00	5 °C	 Quite cool.	2 km/h	→ 92%	1021 mbar	N
04:00	5 °C	 Quite cool.	2 km/h	\ 92%	1022 mbar	N
05:00	5 °C	 Quite cool.	2 km/h	/ 92%	1022 mbar	N
06:00	4 °C	 Quite cool.	4 km/h	↑ 93%	1022 mbar	N
07:00	5 °C	 Quite cool.	2 km/h	/ 94%	1022 mbar	N
08:00	5 °C	 Quite cool.	2 km/h	/ 94%	1023 mbar	N
09:00	5 °C	 Low clouds.	4 km/h	/ 93%	1023 mbar	9





Weather by CustomWeather, © 2019

[24 Apr](#) | 
 [23 Apr](#) | 
 [22 Apr](#) | 
 [21 Apr](#) | 
 [20 Apr](#) | 
 [19 Apr](#) | 
 [18 Apr](#) | 
 [17 Apr](#) | 
 [16 Apr](#) | 
 [15 Apr](#) | 
 [14 Apr](#) | 
 [13 Apr](#) | 
 [12 Apr](#) | 
 [11 Apr](#) | 
 [10 Apr](#) | 
 [9 Apr](#)

Detailed forecast April 26, 2019

Time	Weather	Temp.	Precipitation	Wind	Pressure	Humidity	Dew point	Cloud cover				
								Total	Fog	Low clouds	Middle clouds	High clouds
16:00		12°	0 mm	↓ Light air, 1 m/s from north	1019 hPa	56 %	4°	0 %	0 %	0 %	0 %	0 %
17:00		11°	0 mm	↙ Light breeze, 2 m/s from northeast	1019 hPa	63 %	5°	0 %	0 %	0 %	0 %	0 %
18:00		10°	0 mm	↙ Light breeze, 2 m/s from northeast	1019 hPa	69 %	4°	0 %	0 %	0 %	0 %	0 %
19:00		7°	0 mm	↙ Light breeze, 2 m/s from northeast	1019 hPa	81 %	4°	0 %	0 %	0 %	0 %	0 %
20:00		5°	0 mm	↙ Light breeze, 2 m/s from northeast	1019 hPa	85 %	3°	0 %	0 %	0 %	0 %	0 %
21:00		4°	0 mm	↙ Light breeze, 2 m/s from northeast	1019 hPa	88 %	2°	0 %	0 %	0 %	0 %	0 %
22:00		3°	0 mm	↙ Light air, 1 m/s from east-northeast	1020 hPa	85 %	1°	1 %	0 %	0 %	0 %	0 %
23:00		2°	0 mm	↙ Light air, 1 m/s from east-northeast	1020 hPa	85 %	0°	1 %	0 %	0 %	0 %	0 %

Detailed forecast April 27, 2019

Time	Weather	Temp.	Precipitation	Wind	Pressure	Humidity	Dew point	Cloud cover				
								Total	Fog	Low clouds	Middle clouds	High clouds
00:00		2°	0 mm	↙ Light air, 1 m/s from east-northeast	1020 hPa	85 %	0°	0 %	0 %	0 %	0 %	0 %
01:00		2°	0 mm	↙ Light air, 1 m/s from east-northeast	1021 hPa	85 %	0°	0 %	0 %	0 %	0 %	0 %
02:00		2°	0 mm	↙ Light air, 1 m/s from east-northeast	1021 hPa	86 %	-1°	0 %	0 %	0 %	0 %	0 %
03:00		1°	0 mm	↙ Light air, 1 m/s from east-northeast	1020 hPa	85 %	-1°	2 %	0 %	0 %	0 %	2 %



Time	Weather	Temp.	Precipitation	Wind	Pressure	Humidity	Dew point	Cloud cover				
								Total	Fog	Low clouds	Middle clouds	High clouds
04:00		1°	0 mm	Light air, 1 m/s from east	1020 hPa	83 %	-1°	12 %	0 %	0 %	0 %	12 %
05:00		1°	0 mm	Light air, 1 m/s from east-northeast	1020 hPa	83 %	-1°	10 %	0 %	0 %	0 %	10 %
06:00		2°	0 mm	Light air, 1 m/s from east-northeast	1020 hPa	82 %	-1°	7 %	0 %	0 %	0 %	7 %
07:00		3°	0 mm	Light air, 1 m/s from north-northeast	1020 hPa	82 %	0°	9 %	0 %	0 %	0 %	9 %
08:00		4°	0 mm	Calm, 0 m/s	1021 hPa	83 %	1°	23 %	0 %	0 %	0 %	23 %
09:00		5°	0 mm	Light air, 1 m/s from west-northwest	1021 hPa	87 %	3°	39 %	0 %	0 %	0 %	39 %
10:00		6°	0 mm	Light breeze, 2 m/s from north	1021 hPa	77 %	2°	6 %	0 %	0 %	0 %	6 %
11:00		8°	0 mm	Light breeze, 2 m/s from north	1021 hPa	71 %	3°	0 %	0 %	0 %	0 %	0 %
12:00		9°	0 mm	Light breeze, 2 m/s from southeast	1021 hPa	61 %	2°	37 %	0 %	0 %	0 %	37 %
13:00		10°	0 mm	Light breeze, 2 m/s from southeast	1022 hPa	59 %	2°	91 %	0 %	0 %	0 %	91 %
14:00		10°	0 mm	Light air, 1 m/s from south-southwest	1022 hPa	58 %	3°	88 %	0 %	0 %	0 %	88 %
15:00		11°	0 mm	Light breeze, 2 m/s from south	1022 hPa	59 %	3°	60 %	0 %	0 %	0 %	60 %
16:00		11°	0 mm	Gentle breeze, 4 m/s from south-southeast	1022 hPa	58 %	3°	50 %	0 %	0 %	0 %	50 %
17:00		10°	0 mm	Moderate breeze, 6 m/s from southeast	1021 hPa	58 %	2°	96 %	0 %	0 %	0 %	96 %
18:00		9°	0 mm	Moderate breeze, 6 m/s from south-southeast	1021 hPa	59 %	2°	62 %	0 %	0 %	0 %	62 %
19:00		8°	0 mm	Gentle breeze, 5 m/s from south-southeast	1021 hPa	60 %	1°	44 %	0 %	0 %	0 %	44 %
20:00		7°	0 mm	Gentle breeze, 5 m/s from south-southeast	1021 hPa	61 %	0°	11 %	0 %	0 %	0 %	11 %
21:00		6°	0 mm	Gentle breeze, 4 m/s from south-southeast	1021 hPa	62 %	-1°	1 %	0 %	0 %	0 %	1 %
22:00		4°	0 mm	Light breeze, 3 m/s from south-southeast	1022 hPa	61 %	-2°	3 %	0 %	0 %	0 %	3 %
23:00		4°	0 mm	Light breeze, 3 m/s from south-southeast	1022 hPa	62 %	-3°	45 %	0 %	0 %	0 %	45 %

#### Detailed forecast April 28, 2019

Time	Weather	Temp.	Precipitation	Wind	Pressure	Humidity	Dew point	Cloud cover				
								Total	Fog	Low clouds	Middle clouds	High clouds
00:00		3°	0 mm	Light breeze, 3 m/s from south-southeast	1022 hPa	62 %	-3°	96 %	0 %	0 %	0 %	96 %
01:00		3°	0 mm	Light breeze, 3 m/s from south-southeast	1022 hPa	61 %	-4°	95 %	0 %	0 %	0 %	95 %

Time	Weather	Temp.	Precipitation	Wind	Pressure	Humidity	Dew point	Cloud cover				
								Total	Fog	Low clouds	Middle clouds	High clouds
02:00		3°	0 mm	Light breeze, 2 m/s from south-southeast	1022 hPa	62 %	-4°	80 %	0 %	0 %	0 %	80 %
03:00		2°	0 mm	Light breeze, 3 m/s from south-southeast	1022 hPa	62 %	-4°	78 %	0 %	0 %	0 %	78 %
04:00		3°	0 mm	Light breeze, 3 m/s from south	1022 hPa	61 %	-4°	94 %	0 %	0 %	0 %	94 %
05:00		3°	0 mm	Gentle breeze, 4 m/s from south	1022 hPa	61 %	-4°	96 %	0 %	0 %	0 %	96 %
06:00		4°	0 mm	Gentle breeze, 4 m/s from south	1022 hPa	62 %	-3°	88 %	0 %	0 %	0 %	88 %
07:00		5°	0 mm	Light breeze, 3 m/s from south	1022 hPa	62 %	-2°	93 %	0 %	0 %	0 %	93 %
08:00		6°	0 mm	Light breeze, 3 m/s from south	1022 hPa	62 %	0°	88 %	0 %	0 %	0 %	88 %
09:00		7°	0 mm	Light breeze, 3 m/s from south-southwest	1022 hPa	62 %	1°	57 %	0 %	0 %	0 %	57 %
10:00		9°	0 mm	Light breeze, 3 m/s from south-southwest	1022 hPa	58 %	1°	39 %	0 %	0 %	0 %	39 %
11:00		10°	0 mm	Gentle breeze, 4 m/s from south-southwest	1022 hPa	58 %	2°	10 %	0 %	0 %	0 %	10 %
12:00		11°	0 mm	Light breeze, 3 m/s from south-southwest	1022 hPa	60 %	3°	36 %	0 %	0 %	0 %	36 %
13:00		11°	0 mm	Light breeze, 3 m/s from southwest	1022 hPa	60 %	4°	3 %	0 %	0 %	0 %	3 %
14:00		12°	0 mm	Light breeze, 3 m/s from southwest	1022 hPa	61 %	4°	0 %	0 %	0 %	0 %	0 %





















Detailed forecast April 29, 2019

Time	Weather	Temp.	Precipitation	Wind	Pressure	Humidity	Dew point	Cloud cover				
								Total	Fog	Low clouds	Middle clouds	High clouds
01:00		2°	0 mm	Light breeze, 2 m/s from east-northeast	1025 hPa	87 %	0°	54 %	0 %	1 %	0 %	54 %
02:00		2°	0 mm	Light breeze, 2 m/s from east	1025 hPa	85 %	0°	14 %	0 %	1 %	0 %	12 %
03:00		2°	0 mm	Light breeze, 2 m/s from east-southeast	1025 hPa	76 %	-2°	10 %	0 %	0 %	0 %	10 %
04:00		1°	0 mm	Light air, 1 m/s from east-southeast	1025 hPa	75 %	-3°	54 %	0 %	0 %	0 %	54 %
05:00		2°	0 mm	Light breeze, 3 m/s from east	1026 hPa	75 %	-2°	98 %	0 %	0 %	0 %	98 %
06:00		2°	0 mm	Light breeze, 2 m/s from east-northeast	1026 hPa	74 %	-2°	95 %	0 %	0 %	0 %	95 %
07:00		2°	0 mm	Light air, 1 m/s from north	1026 hPa	88 %	0°	50 %	0 %	0 %	0 %	50 %
08:00		3°	0 mm	Light breeze, 2 m/s from north-northeast	1026 hPa	85 %	1°	0 %	0 %	0 %	0 %	0 %
09:00		4°	0 mm	Light breeze, 3 m/s from north-northeast	1026 hPa	78 %	1°	0 %	0 %	0 %	0 %	0 %
10:00		6°	0 mm	Light breeze, 3 m/s from north-northeast	1026 hPa	68 %	0°	0 %	0 %	0 %	0 %	0 %
11:00		6°	0 mm	Light breeze, 3 m/s from north-northeast	1026 hPa	65 %	0°	0 %	0 %	0 %	0 %	0 %
12:00		7°	0 mm	Gentle breeze, 4 m/s from north-northeast	1026 hPa	62 %	0°	0 %	0 %	0 %	0 %	0 %
13:00		7°	0 mm	Gentle breeze, 4 m/s from north-northeast	1026 hPa	58 %	0°	0 %	0 %	0 %	0 %	0 %
14:00		8°	0 mm	Gentle breeze, 4 m/s from north-northeast	1026 hPa	57 %	0°	0 %	0 %	0 %	0 %	0 %





















Time	Weather	Temp.	Precipitation	Wind	Pressure	Humidity	Dew point	Cloud cover				
								Total	Fog	Low clouds	Middle clouds	High clouds
15:00		8°	0 mm	↙ Light breeze, 3 m/s from north-northeast	1026 hPa	56 %	0°	0 %	0 %	0 %	0 %	0 %
16:00		8°	0 mm	↙ Light breeze, 3 m/s from north-northeast	1025 hPa	56 %	0°	0 %	0 %	0 %	0 %	0 %
17:00		8°	0 mm	↙ Light breeze, 3 m/s from north-northeast	1025 hPa	59 %	0°	0 %	0 %	0 %	0 %	0 %
18:00		7°	0 mm	↙ Light breeze, 2 m/s from north-northeast	1025 hPa	63 %	1°	0 %	0 %	0 %	0 %	0 %
19:00		7°	0 mm	↙ Light breeze, 2 m/s from east-northeast	1025 hPa	68 %	1°	0 %	0 %	0 %	0 %	0 %
20:00		6°	0 mm	← Light breeze, 2 m/s from east	1025 hPa	66 %	0°	0 %	0 %	0 %	0 %	0 %
21:00		4°	0 mm	↘ Light breeze, 2 m/s from east-southeast	1025 hPa	62 %	-2°	10 %	0 %	0 %	0 %	10 %
22:00		3°	0 mm	↘ Light breeze, 3 m/s from southeast	1025 hPa	64 %	-3°	26 %	0 %	0 %	0 %	26 %
23:00		3°	0 mm	↘ Light breeze, 2 m/s from south-southeast	1025 hPa	66 %	-3°	7 %	0 %	0 %	0 %	7 %

#### Detailed forecast April 30, 2019





Time	Weather	Temp.	Precipitation	Wind	Pressure	Humidity	Dew point	Cloud cover				
								Total	Fog	Low clouds	Middle clouds	High clouds
00:00		2°	0 mm	↘ Light breeze, 2 m/s from south-southeast	1025 hPa	67 %	-3°	84 %	0 %	0 %	0 %	84 %
01:00		2°	0 mm	↘ Light breeze, 2 m/s from south-southeast	1024 hPa	71 %	-3°	100 %	0 %	0 %	0 %	100 %
02:00		2°	0 mm	↘ Light breeze, 2 m/s from south-southeast	1024 hPa	73 %	-3°	100 %	0 %	1 %	0 %	100 %
03:00		1°	0 mm	↘ Light breeze, 3 m/s from east-southeast	1024 hPa	76 %	-2°	100 %	0 %	11 %	0 %	100 %
04:00		1°	0 mm	← Light breeze, 3 m/s from east	1023 hPa	88 %	-1°	100 %	0 %	24 %	0 %	99 %
05:00		1°	0 mm	↘ Light breeze, 3 m/s from southeast	1023 hPa	84 %	-1°	98 %	0 %	33 %	0 %	98 %
06:00		2°	0 mm	↙ Light breeze, 2 m/s from south-southwest	1022 hPa	80 %	-1°	99 %	0 %	40 %	0 %	98 %
07:00		3°	0 mm	↙ Light breeze, 3 m/s from south-southwest	1021 hPa	81 %	0°	99 %	0 %	71 %	0 %	96 %
08:00		4°	0 – 0.1 mm	↙ Gentle breeze, 5 m/s from south-southwest	1021 hPa	83 %	1°	99 %	0 %	89 %	0 %	91 %
09:00		4°	0 – 0.1 mm	↙ Gentle breeze, 4 m/s from southwest	1021 hPa	84 %	1°	98 %	0 %	85 %	0 %	90 %
10:00		4°	0 – 0.2 mm	↙ Gentle breeze, 5 m/s from southwest	1020 hPa	87 %	2°	96 %	0 %	94 %	2 %	53 %
11:00		4°	0 – 0.2 mm	← Moderate breeze, 6 m/s from west	1019 hPa	81 %	2°	100 %	0 %	98 %	12 %	79 %
12:00		4°	0 – 0.1 mm	← Gentle breeze, 4 m/s from west	1019 hPa	89 %	2°	100 %	0 %	83 %	26 %	98 %

Time	Weather	Temp.	Precipitation	Wind	Pressure	Humidity	Dew point	Cloud cover				
								Total	Fog	Low clouds	Middle clouds	High clouds
13:00		4°	0 mm	 Gentle breeze, 5 m/s from west	1018 hPa	82 %	2°	100 %	0 %	84 %	54 %	97 %
14:00		5°	0 mm	 Gentle breeze, 5 m/s from west	1018 hPa	78 %	1°	99 %	0 %	88 %	76 %	68 %
15:00		4°	0 mm	 Gentle breeze, 5 m/s from west	1017 hPa	80 %	1°	100 %	0 %	84 %	96 %	93 %
16:00		4°	0 – 0,2 mm	 Gentle breeze, 4 m/s from west	1016 hPa	80 %	1°	100 %	0 %	90 %	94 %	97 %
17:00		4°	0 – 0,3 mm	 Light breeze, 3 m/s from west	1016 hPa	84 %	1°	100 %	1 %	94 %	97 %	99 %
18:00		3°	0,1 – 0,4 mm	 Light breeze, 3 m/s from west	1015 hPa	94 %	2°	100 %	2 %	97 %	99 %	100 %
19:00		3°	0,2 – 0,6 mm	 Light breeze, 2 m/s from west-southwest	1015 hPa	96 %	2°	100 %	1 %	97 %	97 %	100 %
20:00		3°	0,1 – 0,5 mm	 Light breeze, 2 m/s from west-southwest	1014 hPa	95 %	2°	100 %	2 %	98 %	93 %	100 %
21:00		2°	0,1 – 0,4 mm	 Light breeze, 2 m/s from west-southwest	1013 hPa	96 %	2°	100 %	2 %	97 %	94 %	99 %
22:00		2°	0 – 0,3 mm	 Light breeze, 2 m/s from west-southwest	1013 hPa	96 %	2°	100 %	3 %	96 %	95 %	99 %
23:00		2°	0 – 0,3 mm	 Light air, 1 m/s from southwest	1012 hPa	97 %	2°	100 %	3 %	94 %	97 %	100 %

### Detailed forecast April 30, 2019

Time	Weather	Temp.	Precipitation	Wind	Pressure	Humidity	Dew point	Cloud cover				
								Total	Fog	Low clouds	Middle clouds	High clouds
14:00		4°	0 – 0,1 mm	 Gentle breeze, 5 m/s from west	1017 hPa	87 %	2*	100 %	0 %	81 %	43 %	98 %
15:00		4°	0 – 0,1 mm	 Gentle breeze, 5 m/s from west	1016 hPa	83 %	1*	100 %	0 %	85 %	88 %	100 %
16:00		4°	0 – 0,1 mm	 Gentle breeze, 5 m/s from west	1015 hPa	81 %	1*	100 %	0 %	86 %	96 %	100 %
17:00		3°	0 – 0,2 mm	 Gentle breeze, 4 m/s from west	1015 hPa	84 %	1*	100 %	1 %	94 %	97 %	100 %
18:00		2°	0,1 – 0,3 mm	 Light breeze, 2 m/s from west-southwest	1014 hPa	94 %	1*	100 %	0 %	95 %	91 %	100 %
19:00		2°	0 – 0,2 mm	 Light breeze, 3 m/s from west	1013 hPa	93 %	1*	100 %	8 %	94 %	87 %	100 %
20:00		2°	0 – 0,2 mm	 Calm, 0 m/s from east-southeast	1012 hPa	98 %	1*	100 %	2 %	87 %	98 %	100 %
21:00		2°	0 – 0,1 mm	 Light air, 1 m/s from east-southeast	1012 hPa	96 %	1*	100 %	0 %	85 %	96 %	97 %
22:00		2°	0 – 0,1 mm	 Light breeze, 2 m/s from southeast	1011 hPa	93 %	1*	100 %	0 %	95 %	94 %	91 %
23:00		2°	0,1 – 0,9 mm	 Light breeze, 2 m/s from southeast	1011 hPa	92 %	1*	100 %	10 %	98 %	94 %	68 %

























### Detailed forecast May 1, 2019

Time	Weather	Temp.	Precipitation	Wind	Pressure	Humidity	Dew point	Cloud cover				
								Total	Fog	Low clouds	Middle clouds	High clouds
00:00		1°	0,2 – 0,7 mm	 Light breeze, 3 m/s from north-northeast	1011 hPa	98 %	1*	98 %	1 %	92 %	89 %	20 %
01:00		1°	0 – 0,2 mm	 Gentle breeze, 5 m/s from northeast	1010 hPa	91 %	0*	84 %	0 %	83 %	16 %	0 %

Time	Weather	Temp.	Precipitation	Wind	Pressure	Humidity	Dew point	Cloud cover				
								Total	Fog	Low clouds	Middle clouds	High clouds
02:00		1°	0 mm	Gentle breeze, 5 m/s from northeast	1010 hPa	91 %	-1°	79 %	0 %	79 %	0 %	0 %
03:00		0°	0 mm	Gentle breeze, 4 m/s from northeast	1010 hPa	92 %	-1°	85 %	1 %	85 %	0 %	0 %
04:00		0°	0 – 0.1 mm	Gentle breeze, 4 m/s from northeast	1010 hPa	93 %	-1°	83 %	0 %	83 %	0 %	0 %
05:00		0°	0 mm	Gentle breeze, 4 m/s from northeast	1010 hPa	88 %	-2°	70 %	0 %	70 %	0 %	0 %
06:00		0°	0 mm	Gentle breeze, 5 m/s from northeast	1010 hPa	80 %	-3°	54 %	0 %	54 %	0 %	0 %
07:00		0°	0 mm	Moderate breeze, 6 m/s from northeast	1009 hPa	74 %	-4°	53 %	0 %	53 %	0 %	0 %
08:00		0°	0 mm	Gentle breeze, 5 m/s from northeast	1009 hPa	68 %	-5°	49 %	0 %	49 %	0 %	0 %
09:00		0°	0 mm	Gentle breeze, 5 m/s from northeast	1009 hPa	64 %	-6°	41 %	0 %	41 %	0 %	0 %
10:00		1°	0 mm	Gentle breeze, 5 m/s from northeast	1008 hPa	59 %	-6°	61 %	0 %	61 %	1 %	0 %
11:00		1°	0 mm	Gentle breeze, 5 m/s from northeast	1008 hPa	58 %	-6°	69 %	0 %	69 %	0 %	0 %
12:00		1°	0 mm	Gentle breeze, 5 m/s from northeast	1008 hPa	59 %	-6°	86 %	0 %	85 %	2 %	0 %
13:00		1°	0 – 0.1 mm	Gentle breeze, 5 m/s from northeast	1008 hPa	59 %	-6°	90 %	0 %	90 %	9 %	1 %
14:00		0°	0 – 0.1 mm	Moderate breeze, 6 m/s from northeast	1008 hPa	72 %	-4°	88 %	0 %	86 %	13 %	16 %
15:00		0°	0 – 0.1 mm	Gentle breeze, 4 m/s from northeast	1007 hPa	72 %	-4°	82 %	0 %	62 %	16 %	55 %
16:00		0°	0 mm	Gentle breeze, 5 m/s from northeast	1007 hPa	68 %	-5°	84 %	0 %	40 %	12 %	73 %
17:00		0°	0 mm	Moderate breeze, 6 m/s from northeast	1006 hPa	59 %	-6°	79 %	0 %	16 %	4 %	74 %
18:00		0°	0 mm	Moderate breeze, 6 m/s from northeast	1006 hPa	62 %	-6°	69 %	0 %	7 %	2 %	66 %
19:00		0°	0 mm	Moderate breeze, 6 m/s from northeast	1006 hPa	63 %	-6°	73 %	0 %	1 %	0 %	73 %
20:00		-1°	0 mm	Gentle breeze, 5 m/s from northeast	1006 hPa	65 %	-7°	86 %	0 %	0 %	0 %	86 %
21:00		-1°	0 mm	Gentle breeze, 4 m/s from northeast	1006 hPa	69 %	-6°	90 %	0 %	0 %	0 %	90 %
22:00		-2°	0 mm	Gentle breeze, 4 m/s from east-northeast	1005 hPa	71 %	-7°	98 %	0 %	20 %	2 %	97 %
23:00		-2°	0 mm	Gentle breeze, 4 m/s from east-northeast	1005 hPa	71 %	-7°	98 %	0 %	40 %	6 %	97 %

#### Detailed forecast May 2, 2019





















Time	Weather	Temp.	Precipitation	Wind	Pressure	Humidity	Dew point	Cloud cover				
								Total	Fog	Low clouds	Middle clouds	High clouds

Time	Weather	Temp.	Precipitation	Wind	Pressure	Humidity	Dew point	Cloud cover				
								Total	Fog	Low clouds	Middle clouds	High clouds
00:00		-2°	0 mm	 Gentle breeze, 4 m/s from east	1005 hPa	77 %	-6°	98 %	0 %	46 %	27 %	97 %
01:00		-2°	0 – 0.1 mm	 Gentle breeze, 4 m/s from east	1005 hPa	80 %	-5°	100 %	1 %	68 %	71 %	97 %
02:00		-2°	0 – 0.2 mm	 Light breeze, 3 m/s from east-northeast	1005 hPa	81 %	-5°	100 %	1 %	74 %	87 %	99 %
03:00		-2°	0 – 0.1 mm	 Gentle breeze, 4 m/s from northeast	1005 hPa	85 %	-4°	100 %	0 %	64 %	92 %	94 %
04:00		-2°	0 – 0.1 mm	 Light breeze, 3 m/s from northeast	1005 hPa	89 %	-4°	100 %	0 %	68 %	95 %	88 %
05:00		-2°	0 – 0.1 mm	 Light breeze, 3 m/s from northeast	1004 hPa	89 %	-4°	99 %	1 %	57 %	92 %	74 %
06:00		-2°	0 mm	 Light breeze, 3 m/s from northeast	1004 hPa	85 %	-4°	97 %	0 %	39 %	76 %	80 %
07:00		-1°	0 mm	 Gentle breeze, 4 m/s from northeast	1004 hPa	75 %	-5°	99 %	0 %	45 %	64 %	95 %
08:00		-1°	0 mm	 Gentle breeze, 4 m/s from northeast	1004 hPa	69 %	-6°	99 %	0 %	26 %	58 %	96 %
09:00		-1°	0 mm	 Gentle breeze, 4 m/s from east-northeast	1004 hPa	66 %	-6°	98 %	0 %	33 %	59 %	93 %
10:00		-1°	0 mm	 Gentle breeze, 4 m/s from east-northeast	1004 hPa	63 %	-7°	96 %	0 %	44 %	67 %	84 %
11:00		0°	0 mm	 Gentle breeze, 5 m/s from east-northeast	1004 hPa	61 %	-7°	95 %	0 %	38 %	65 %	82 %
12:00		0°	0 mm	 Gentle breeze, 5 m/s from east-northeast	1005 hPa	58 %	-7°	95 %	0 %	33 %	66 %	80 %







## Tromsø Weather History for the Previous 24 Hours





















Show weather for:

Time	Conditions			Comfort		
	Temp	Weather	Wind	Humidity	Barometer	
08:00 Fri, 3 May	 -1 °C	Overcast.	13 km/h ↓	78%	1004 mbar	
06:00	 -1 °C	Overcast.	9 km/h ↓	81%	1005 mbar	
05:00	 -2 °C	Light snow, Overcast.	7 km/h ↓	79%	1005 mbar	
04:00	 -2 °C	Overcast.	7 km/h ↘	76%	1006 mbar	
03:00	 -2 °C	Overcast.	6 km/h ↘	69%	1006 mbar	
02:00	 -3 °C	Clear.	6 km/h ↘	65%	1007 mbar	
01:00	 -2 °C	Passing clouds.	4 km/h ←	62%	1007 mbar	
00:00	 -1 °C	Passing clouds.	11 km/h ↘	58%	1007 mbar	
23:00 Thu, 2 May	 -1 °C	Clear.	15 km/h ↘	58%	1007 mbar	
22:00	 -1 °C	Scattered clouds.	15 km/h ↘	57%	1007 mbar	
21:00	 0 °C	Chilly.	15 km/h ↘	63%	1007 mbar	
20:00	 0 °C	Rain showers, Scattered clouds.	13 km/h ↘	54%	1006 mbar	
19:00	 1 °C	Passing clouds.	17 km/h ↘	52%	1006 mbar	
18:00	 1 °C	Sunny.	13 km/h ↘	43%	1006 mbar	
17:00	 1 °C	Passing clouds.	13 km/h ↘	51%	1006 mbar	
16:00	 2 °C	Passing clouds.	17 km/h ↘	47%	1005 mbar	
15:00	 1 °C	Partly sunny.	13 km/h ↘	53%	1005 mbar	
14:00	 1 °C	Scattered clouds.	15 km/h ↘	51%	1005 mbar	
13:00	 1 °C	Passing clouds.	11 km/h ↘	50%	1004 mbar	
12:00	 1 °C	Partly sunny.	9 km/h ↘	58%	1004 mbar	
11:00	 0 °C	Scattered clouds.	9 km/h ↘	62%	1004 mbar	

Detailed forecast May 8, 2019

Time	Weather	Temp.	Precipitation	Wind	Pressure	Humidity	Dew point	Cloud cover				
								Total	Fog	Low clouds	Middle clouds	High clouds
22:00		1°	0 – 0,1 mm	 Light breeze, 2 m/s from north-northwest	1003 hPa	98 %	1°	100 %	2 %	94 %	48 %	95 %
23:00		1°	0 – 0,2 mm	 Calm, 0 m/s from south-southwest	1003 hPa	98 %	1°	100 %	2 %	83 %	36 %	97 %



























Detailed forecast May 9, 2019

Time	Weather	Temp.	Precipitation	Wind	Pressure	Humidity	Dew point	Cloud cover				
								Total	Fog	Low clouds	Middle clouds	High clouds
00:00		1°	0 – 0,3 mm	 Light air, 1 m/s from southwest	1004 hPa	98 %	1°	100 %	2 %	75 %	36 %	97 %
01:00		1°	0 – 0,3 mm	 Light breeze, 2 m/s from south-southwest	1005 hPa	95 %	1°	96 %	1 %	60 %	18 %	89 %
02:00		1°	0 mm	 Light air, 1 m/s from south-southwest	1006 hPa	94 %	0°	96 %	0 %	74 %	13 %	82 %
03:00		2°	0 mm	 Light breeze, 2 m/s from southwest	1007 hPa	89 %	0°	96 %	0 %	76 %	8 %	82 %
04:00		2°	0 mm	 Light breeze, 2 m/s from south-southwest	1007 hPa	88 %	0°	97 %	0 %	77 %	4 %	89 %
05:00		2°	0 mm	 Light breeze, 2 m/s from south-southwest	1008 hPa	89 %	0°	99 %	0 %	75 %	1 %	95 %
06:00		2°	0 mm	 Light breeze, 2 m/s from south-southwest	1009 hPa	85 %	0°	98 %	0 %	77 %	1 %	90 %
07:00		3°	0 mm	 Light breeze, 3 m/s from south-southwest	1010 hPa	82 %	0°	96 %	0 %	76 %	0 %	78 %
08:00		4°	0 mm	 Gentle breeze, 4 m/s from south-southwest	1010 hPa	86 %	1°	92 %	0 %	78 %	0 %	61 %
09:00		4°	0 mm	 Gentle breeze, 4 m/s from south-southwest	1011 hPa	86 %	2°	73 %	0 %	64 %	0 %	28 %

Time	Weather	Temp.	Precipitation	Wind	Pressure	Humidity	Dew point	Cloud cover				
								Total	Fog	Low clouds	Middle clouds	High clouds
10:00		4°	0 mm	Gentle breeze, 4 m/s from southwest	1012 hPa	82 %	2°	42 %	0 %	38 %	0 %	9 %
11:00		5°	0 mm	Light breeze, 3 m/s from southwest	1013 hPa	75 %	1°	30 %	0 %	10 %	8 %	14 %
12:00		6°	0 mm	Light breeze, 3 m/s from southwest	1014 hPa	68 %	0°	65 %	0 %	2 %	46 %	33 %
13:00		6°	0 mm	Light breeze, 2 m/s from southwest	1014 hPa	66 %	0°	61 %	0 %	1 %	58 %	7 %
14:00		6°	0 mm	Light air, 1 m/s from west-southwest	1015 hPa	63 %	0°	23 %	0 %	1 %	22 %	0 %
15:00		6°	0 mm	Calm, 0 m/s from west-northwest	1015 hPa	62 %	-1°	14 %	0 %	2 %	13 %	0 %
16:00		7°	0 mm	Light air, 1 m/s from northeast	1015 hPa	60 %	0°	2 %	0 %	1 %	1 %	0 %
17:00		7°	0 mm	Light breeze, 2 m/s from north-northeast	1015 hPa	62 %	0°	17 %	0 %	0 %	0 %	17 %
18:00		7°	0 mm	Light breeze, 2 m/s from east-southeast	1015 hPa	64 %	1°	8 %	0 %	0 %	0 %	8 %
19:00		6°	0 mm	Gentle breeze, 5 m/s from east-southeast	1015 hPa	64 %	0°	20 %	0 %	0 %	0 %	20 %
20:00		6°	0 mm	Gentle breeze, 5 m/s from southeast	1015 hPa	64 %	-1°	5 %	0 %	0 %	0 %	4 %
21:00		5°	0 mm	Gentle breeze, 5 m/s from southeast	1015 hPa	64 %	-1°	2 %	0 %	0 %	1 %	1 %
22:00		4°	0 mm	Gentle breeze, 4 m/s from southeast	1015 hPa	61 %	-3°	22 %	0 %	0 %	6 %	17 %
23:00		4°	0 mm	Gentle breeze, 4 m/s from southeast	1015 hPa	65 %	-2°	90 %	0 %	21 %	48 %	77 %

#### Detailed forecast May 10, 2019

Time	Weather	Temp.	Precipitation	Wind	Pressure	Humidity	Dew point	Cloud cover				
								Total	Fog	Low clouds	Middle clouds	High clouds
00:00		4°	0 mm	Gentle breeze, 4 m/s from south-southeast	1015 hPa	70 %	-1°	98 %	0 %	44 %	77 %	86 %
01:00		4°	0-0.2 mm	Gentle breeze, 4 m/s from south-southeast	1015 hPa	75 %	0°	99 %	0 %	67 %	84 %	87 %
02:00		4°	0-0.1 mm	Light breeze, 3 m/s from south-southeast	1016 hPa	82 %	2°	96 %	0 %	32 %	82 %	72 %
03:00		4°	0 mm	Gentle breeze, 4 m/s from south-southeast	1015 hPa	83 %	2°	98 %	0 %	17 %	64 %	94 %
04:00		4°	0 mm	Light breeze, 3 m/s from south	1015 hPa	79 %	1°	100 %	0 %	34 %	87 %	98 %
05:00		4°	0 mm	Light breeze, 2 m/s from south	1015 hPa	76 %	1°	100 %	0 %	46 %	92 %	98 %
06:00		5°	0 mm	Gentle breeze, 4 m/s from southeast	1015 hPa	73 %	1°	100 %	0 %	40 %	92 %	99 %
07:00		7°	0 mm	Moderate breeze, 6 m/s from southeast	1015 hPa	71 %	2°	100 %	0 %	34 %	89 %	100 %

Time	Weather	Temp.	Precipitation	Wind	Pressure	Humidity	Dew point	Cloud cover				
								Total	Fog	Low clouds	Middle clouds	High clouds
08:00		8°	0 mm	 Fresh breeze, 9 m/s from south-southeast	1015 hPa	70 %	3°	100 %	0 %	14 %	76 %	97 %
09:00		9°	0 mm	 Fresh breeze, 9 m/s from south-southeast	1014 hPa	69 %	3°	85 %	0 %	7 %	57 %	64 %
10:00		10°	0 mm	 Fresh breeze, 9 m/s from south-southeast	1014 hPa	67 %	4°	63 %	0 %	3 %	33 %	43 %
11:00		10°	0 mm	 Fresh breeze, 10 m/s from south-southeast	1014 hPa	65 %	4°	32 %	0 %	1 %	14 %	22 %
12:00		11°	0 mm	 Fresh breeze, 9 m/s from south-southeast	1014 hPa	64 %	4°	64 %	0 %	0 %	2 %	63 %
13:00		11°	0 mm	 Fresh breeze, 9 m/s from south-southeast	1014 hPa	63 %	4°	56 %	0 %	0 %	2 %	55 %
14:00		11°	0 mm	 Fresh breeze, 8 m/s from south-southeast	1014 hPa	61 %	4°	54 %	0 %	0 %	0 %	54 %
15:00		11°	0 mm	 Fresh breeze, 8 m/s from south-southeast	1014 hPa	60 %	4°	59 %	0 %	0 %	0 %	59 %
16:00		11°	0 mm	 Fresh breeze, 8 m/s from southeast	1013 hPa	58 %	3°	75 %	0 %	0 %	0 %	75 %
17:00		11°	0 mm	 Fresh breeze, 8 m/s from south-southeast	1013 hPa	58 %	3°	62 %	0 %	0 %	0 %	62 %
18:00		10°	0 mm	 Moderate breeze, 7 m/s from south-southeast	1013 hPa	61 %	3°	89 %	0 %	0 %	0 %	89 %
19:00		10°	0 mm	 Gentle breeze, 5 m/s from south-southeast	1013 hPa	63 %	3°	94 %	0 %	0 %	0 %	94 %
20:00		9°	0 mm	 Gentle breeze, 4 m/s from south-southeast	1012 hPa	64 %	3°	95 %	0 %	0 %	0 %	95 %

### Today and tonight, 11 May 2019

Time	Forecast	Temp.	Precip.	Wind
Saturday 12:00		9°	0 mm	Gentle breeze, 4 m/s from south
Saturday 13:00		10°	0 mm	Light breeze, 3 m/s from south-southwest
Saturday 14:00		11°	0 mm	Light breeze, 2 m/s from southwest
Saturday 15:00		12°	0 mm	Light breeze, 2 m/s from southwest
Saturday 16:00		12°	0 mm	Light air, 1 m/s from south-southwest
Saturday 17:00		12°	0 mm	Light air, 1 m/s from south-southwest
Saturday 18:00		12°	0 mm	Light air, 1 m/s from south
Saturday 19:00		11°	0 mm	Light breeze, 3 m/s from south-southeast
Saturday 20:00		10°	0 mm	Light breeze, 3 m/s from southeast
Saturday 21:00		9°	0 mm	Light breeze, 3 m/s from southeast
Saturday 22:00		8°	0 mm	Light breeze, 3 m/s from southeast
Saturday 23:00		8°	0 mm	Light breeze, 3 m/s from southeast
Sunday 00:00		7°	0 mm	Light breeze, 2 m/s from east-southeast

Time	Forecast	Temp.	Precip.	Wind
Sunday 01:00		7°	0 mm	Light breeze, 2 m/s from east-southeast
Sunday 02:00		6°	0 mm	Light breeze, 2 m/s from east-southeast
Sunday 03:00		6°	0 mm	Light breeze, 2 m/s from east
Sunday 04:00		6°	0 mm	Light breeze, 2 m/s from east
Sunday 05:00		6°	0 mm	Light breeze, 3 m/s from east

### Tomorrow, 12 May 2019

Time	Forecast	Temp.	Precip.	Wind
Sunday 06:00		7°	0 mm	Light breeze, 2 m/s from east-northeast
Sunday 07:00		7°	0 mm	Light breeze, 3 m/s from east-northeast
Sunday 08:00		8°	0 mm	Light breeze, 3 m/s from northeast
Sunday 09:00		7°	0,2–0,4 mm	Light breeze, 3 m/s from northeast
Sunday 10:00		6°	0,4–0,7 mm	Light breeze, 3 m/s from northeast
Sunday 11:00		6°	0,3–0,7 mm	Light breeze, 3 m/s from northeast
Sunday 12:00		6°	0,4–0,7 mm	Light breeze, 3 m/s from northeast
Sunday 13:00		6°	0,4–0,8 mm	Gentle breeze, 4 m/s from northeast
Sunday 14:00		6°	0,5–0,7 mm	Gentle breeze, 4 m/s from north-northeast
Sunday 15:00		6°	0,7–1,4 mm	Gentle breeze, 4 m/s from north-northeast
Sunday 16:00		6°	0,2–0,8 mm	Gentle breeze, 4 m/s from north-northeast
Sunday 17:00		6°	0,1–0,5 mm	Gentle breeze, 4 m/s from north-northeast
Sunday 18:00		6°	0,2–0,4 mm	Light breeze, 3 m/s from north-northeast

Time	Forecast	Temp.	Precip.	Wind
Sunday 19:00		5°	0,2–0,6 mm	Light breeze, 3 m/s from north-northeast
Sunday 20:00		5°	0,3–0,8 mm	Light breeze, 2 m/s from north-northeast
Sunday 21:00		5°	0,6–0,9 mm	Light air, 1 m/s from northeast
Sunday 22:00		5°	0,6–1,1 mm	○ Calm, 0 m/s
Sunday 23:00		4°	0,6–1,3 mm	Light air, 1 m/s from northwest

# Longyearbyen (Svalbard)



Expected: **Moderate avalanche danger**  
Yellow severity



## Detailed meteogram, next 48 hours

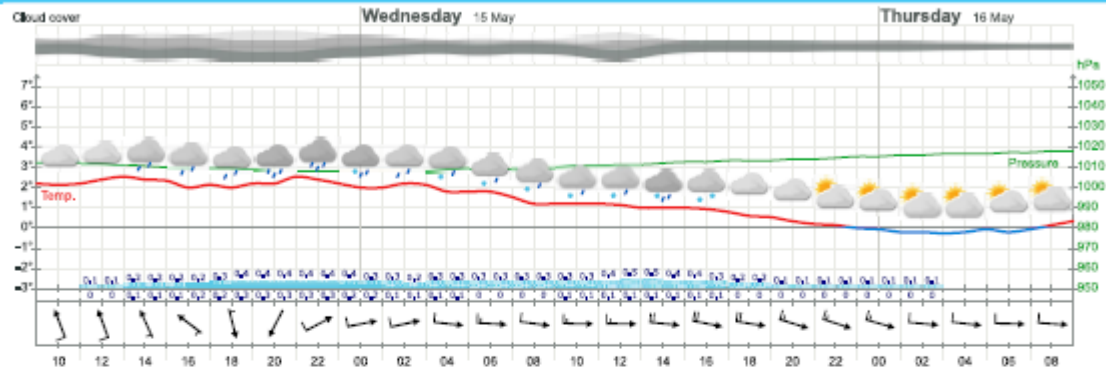

## Detailed forecast May 14, 2019

Time	Weather	Temp.	Precipitation	Wind	Pressure	Humidity	Dew point	Cloud cover				
								Total	Fog	Low clouds	Middle clouds	High clouds
09:00		2°	0 mm	↘ Gentle breeze, 5 m/s from south-southeast	1012 hPa	84 %	0°	100 %	0 %	100 %	38 %	0 %
10:00		2°	0 mm	↘ Moderate breeze, 6 m/s from south-southeast	1012 hPa	84 %	0°	100 %	0 %	100 %	46 %	0 %
11:00		2°	0 – 0,1 mm	↘ Gentle breeze, 5 m/s from south-southeast	1012 hPa	85 %	0°	100 %	0 %	100 %	90 %	0 %
12:00		2°	0 – 0,1 mm	↘ Gentle breeze, 4 m/s from south-southeast	1011 hPa	85 %	0°	100 %	0 %	100 %	100 %	8 %
13:00		2°	0,1 – 0,2 mm	↘ Light breeze, 3 m/s from south-southeast	1011 hPa	86 %	0°	100 %	0 %	99 %	100 %	37 %
14:00		2°	0,1 – 0,2 mm	↘ Light breeze, 2 m/s from south-southeast	1011 hPa	88 %	1°	100 %	0 %	100 %	99 %	34 %
15:00		2°	0,1 – 0,2 mm	↙ Light air, 1 m/s from southeast	1010 hPa	90 %	1°	100 %	2 %	100 %	100 %	20 %
16:00		2°	0,2 mm	↓ Light air, 1 m/s from north	1010 hPa	95 %	1°	100 %	3 %	100 %	100 %	41 %
17:00		2°	0,2 – 0,3 mm	↓ Light air, 1 m/s from north-northwest	1009 hPa	96 %	2°	100 %	3 %	100 %	99 %	78 %
18:00		2°	0,3 – 0,4 mm	↓ Light air, 1 m/s from north	1009 hPa	96 %	1°	100 %	2 %	100 %	100 %	95 %
19:00		2°	0,3 – 0,4 mm	↙ Light air, 1 m/s from north-northeast	1008 hPa	95 %	1°	100 %	3 %	100 %	100 %	94 %
20:00		2°	0,3 – 0,4 mm	↙ Light air, 1 m/s from east-southeast	1008 hPa	96 %	2°	100 %	0 %	100 %	100 %	86 %

Time	Weather	Temp.	Precipitation	Wind	Pressure	Humid-ity	Dew point	Cloud cover				
								Total	Fog	Low clouds	Middle clouds	High clouds
21:00		2°	0,3 – 0,4 mm	Gentle breeze, 4 m/s from west-southwest	1008 hPa	85 %	0°	100 %	0 %	100 %	100 %	49 %
22:00		2°	0,3 – 0,4 mm	Gentle breeze, 4 m/s from west	1008 hPa	86 %	0°	100 %	0 %	100 %	98 %	13 %
23:00		2°	0,2 – 0,4 mm	Gentle breeze, 5 m/s from west-southwest	1008 hPa	86 %	0°	100 %	0 %	100 %	97 %	4 %

### Detailed forecast May 15, 2019

Time	Weather	Temp.	Precipitation	Wind	Pressure	Humid-ity	Dew point	Cloud cover				
								Total	Fog	Low clouds	Middle clouds	High clouds
00:00		2°	0,2 – 0,3 mm	Gentle breeze, 5 m/s from west-southwest	1008 hPa	86 %	0°	100 %	0 %	100 %	80 %	0 %
01:00		2°	0,1 – 0,3 mm	Gentle breeze, 5 m/s from west-southwest	1008 hPa	87 %	0°	100 %	0 %	100 %	58 %	0 %
02:00		2°	0,1 – 0,2 mm	Gentle breeze, 5 m/s from west	1008 hPa	88 %	0°	100 %	0 %	100 %	37 %	0 %
03:00		2°	0,1 – 0,3 mm	Moderate breeze, 6 m/s from west	1008 hPa	88 %	0°	100 %	0 %	100 %	30 %	7 %
04:00		2°	0,1 – 0,3 mm	Moderate breeze, 7 m/s from west	1008 hPa	87 %	0°	100 %	0 %	99 %	24 %	36 %
05:00		2°	0 – 0,3 mm	Moderate breeze, 7 m/s from west	1009 hPa	87 %	0°	100 %	1 %	99 %	21 %	40 %
06:00		2°	0 – 0,3 mm	Moderate breeze, 6 m/s from west-northwest	1009 hPa	88 %	0°	100 %	1 %	99 %	15 %	24 %
07:00		2°	0 – 0,3 mm	Moderate breeze, 6 m/s from west	1009 hPa	87 %	0°	100 %	0 %	100 %	15 %	24 %
08:00		1°	0 – 0,3 mm	Fresh breeze, 8 m/s from west	1010 hPa	87 %	-1°	100 %	1 %	100 %	15 %	33 %
09:00		1°	0,1 – 0,3 mm	Fresh breeze, 8 m/s from west	1010 hPa	86 %	-1°	100 %	1 %	99 %	25 %	57 %
10:00		1°	0,1 – 0,3 mm	Fresh breeze, 8 m/s from west	1010 hPa	86 %	-1°	100 %	0 %	99 %	56 %	80 %
11:00		1°	0,1 – 0,4 mm	Fresh breeze, 8 m/s from west	1011 hPa	86 %	-1°	100 %	1 %	99 %	82 %	76 %
12:00		1°	0,1 – 0,5 mm	Fresh breeze, 9 m/s from west	1011 hPa	86 %	-1°	100 %	1 %	99 %	71 %	42 %
13:00		1°	0,1 – 0,5 mm	Fresh breeze, 10 m/s from west	1011 hPa	87 %	-1°	100 %	1 %	99 %	44 %	5 %
14:00		1°	0,1 – 0,4 mm	Fresh breeze, 10 m/s from west	1012 hPa	86 %	-1°	99 %	1 %	98 %	17 %	0 %
15:00		1°	0,1 – 0,4 mm	Fresh breeze, 10 m/s from west	1012 hPa	85 %	-1°	97 %	0 %	97 %	4 %	0 %
16:00		1°	0,1 – 0,3 mm	Fresh breeze, 9 m/s from west	1012 hPa	85 %	-1°	97 %	0 %	96 %	2 %	0 %
17:00		1°	0 – 0,2 mm	Fresh breeze, 9 m/s from west	1013 hPa	85 %	-2°	96 %	0 %	96 %	2 %	0 %
18:00		1°	0 – 0,2 mm	Fresh breeze, 9 m/s from west-northwest	1013 hPa	85 %	-2°	97 %	0 %	96 %	3 %	0 %
19:00		0°	0 – 0,1 mm	Fresh breeze, 8 m/s from west-northwest	1013 hPa	85 %	-2°	96 %	0 %	95 %	4 %	0 %

Time	Weather	Temp.	Precipitation	Wind	Pressure	Humidity	Dew point	Cloud cover				
								Total	Fog	Low clouds	Middle clouds	High clouds
20:00		0°	0 – 0,1 mm	Fresh breeze, 8 m/s from west-northwest	1014 hPa	84 %	-2°	89 %	0 %	88 %	2 %	0 %
21:00		0°	0 – 0,1 mm	Fresh breeze, 8 m/s from west-northwest	1014 hPa	84 %	-2°	84 %	0 %	84 %	1 %	0 %
22:00		0°	0 – 0,1 mm	Moderate breeze, 7 m/s from west-northwest	1014 hPa	84 %	-2°	84 %	0 %	83 %	1 %	0 %
23:00		0°	0 – 0,1 mm	Moderate breeze, 6 m/s from west-northwest	1015 hPa	84 %	-2°	85 %	0 %	84 %	1 %	0 %

#### Detailed forecast May 16, 2019

Time	Weather	Temp.	Precipitation	Wind	Pressure	Humidity	Dew point	Cloud cover				
								Total	Fog	Low clouds	Middle clouds	High clouds
00:00		0°	0 – 0,1 mm	Moderate breeze, 6 m/s from west	1015 hPa	85 %	-2°	84 %	0 %	84 %	0 %	0 %
01:00		0°	0 – 0,1 mm	Moderate breeze, 6 m/s from west	1016 hPa	86 %	-2°	79 %	0 %	79 %	0 %	0 %
02:00		0°	0 – 0,1 mm	Moderate breeze, 6 m/s from west	1016 hPa	85 %	-2°	71 %	0 %	71 %	0 %	0 %
03:00		0°	0 mm	Moderate breeze, 6 m/s from west	1016 hPa	85 %	-2°	69 %	0 %	68 %	0 %	0 %
04:00		0°	0 mm	Gentle breeze, 5 m/s from west	1017 hPa	85 %	-2°	64 %	0 %	62 %	0 %	0 %
05:00		0°	0 mm	Moderate breeze, 6 m/s from west	1017 hPa	84 %	-2°	59 %	0 %	58 %	0 %	0 %
06:00		0°	0 mm	Moderate breeze, 6 m/s from west	1017 hPa	84 %	-3°	55 %	0 %	54 %	0 %	0 %
07:00		0°	0 mm	Gentle breeze, 5 m/s from west	1017 hPa	84 %	-2°	56 %	0 %	55 %	0 %	0 %



**Detailed forecast May 20, 2019**

Time	Weather	Temp.	Precipitation	Wind	Pressure	Humidity	Dew point	Cloud cover				
								Total	Fog	Low clouds	Middle clouds	High clouds
13:00		16°	0 mm	↘ Light air, 1 m/s from northeast	1016 hPa	67 %	10°	54 %	0 %	0 %	0 %	54 %
14:00		16°	0 mm	← Light breeze, 2 m/s from east	1016 hPa	68 %	10°	39 %	0 %	0 %	0 %	39 %
15:00		16°	0 mm	← Light breeze, 3 m/s from east	1016 hPa	70 %	11°	35 %	0 %	0 %	0 %	35 %
16:00		15°	0 mm	← Gentle breeze, 4 m/s from east	1016 hPa	70 %	10°	15 %	0 %	0 %	0 %	15 %
17:00		15°	0 mm	← Gentle breeze, 4 m/s from east	1016 hPa	70 %	9°	53 %	0 %	0 %	0 %	53 %
18:00		14°	0 mm	↙ Gentle breeze, 4 m/s from east-southeast	1016 hPa	70 %	8°	11 %	0 %	0 %	0 %	11 %
19:00		13°	0 mm	↙ Gentle breeze, 4 m/s from east-southeast	1016 hPa	70 %	8°	96 %	0 %	0 %	0 %	96 %
20:00		12°	0 mm	↙ Gentle breeze, 4 m/s from east-southeast	1016 hPa	70 %	7°	99 %	0 %	0 %	0 %	99 %
21:00		11°	0 mm	← Gentle breeze, 4 m/s from east	1017 hPa	69 %	5°	99 %	0 %	0 %	0 %	99 %
22:00		10°	0 mm	← Light breeze, 3 m/s from east	1017 hPa	69 %	4°	98 %	0 %	0 %	0 %	98 %
23:00		9°	0 mm	← Light breeze, 3 m/s from east-southeast	1017 hPa	70 %	3°	80 %	0 %	0 %	0 %	80 %

























**Detailed forecast May 21, 2019**

Time	Weather	Temp.	Precipitation	Wind	Pressure	Humidity	Dew point	Cloud cover				
								Total	Fog	Low clouds	Middle clouds	High clouds
00:00		8°	0 mm	↙ Light breeze, 2 m/s from east-southeast	1018 hPa	73 %	3°	79 %	0 %	0 %	0 %	79 %

Time	Weather	Temp.	Precipitation	Wind	Pressure	Humidity	Dew point	Cloud cover				
								Total	Fog	Low clouds	Middle clouds	High clouds
01:00		7°	0 mm	Light breeze, 2 m/s from east	1018 hPa	76 %	3°	38 %	0 %	0 %	0 %	38 %
02:00		6°	0 mm	Light breeze, 2 m/s from east-southeast	1018 hPa	78 %	3°	30 %	0 %	0 %	0 %	30 %
03:00		6°	0 mm	Light air, 1 m/s from east-southeast	1019 hPa	78 %	3°	13 %	0 %	0 %	0 %	13 %
04:00		6°	0 mm	Light air, 1 m/s from southeast	1019 hPa	78 %	3°	3 %	0 %	0 %	0 %	3 %
05:00		7°	0 mm	Light air, 1 m/s from east-southeast	1019 hPa	78 %	3°	2 %	0 %	0 %	0 %	2 %
06:00		8°	0 mm	Light air, 1 m/s from north-northwest	1019 hPa	84 %	5°	4 %	0 %	0 %	0 %	4 %
07:00		9°	0 mm	Light breeze, 2 m/s from northwest	1019 hPa	84 %	6°	6 %	0 %	0 %	0 %	6 %
08:00		10°	0 mm	Light air, 1 m/s from north-northwest	1019 hPa	80 %	7°	4 %	0 %	0 %	0 %	4 %
09:00		12°	0 mm	Light breeze, 2 m/s from east	1018 hPa	74 %	7°	1 %	0 %	0 %	0 %	1 %
10:00		13°	0 mm	Light breeze, 2 m/s from east-southeast	1019 hPa	70 %	7°	0 %	0 %	0 %	0 %	0 %
11:00		13°	0 mm	Light breeze, 2 m/s from east	1019 hPa	68 %	7°	0 %	0 %	0 %	0 %	0 %
12:00		14°	0 mm	Light breeze, 2 m/s from east	1019 hPa	66 %	8°	0 %	0 %	0 %	0 %	0 %
13:00		14°	0 mm	Light breeze, 2 m/s from east	1019 hPa	66 %	8°	0 %	0 %	0 %	0 %	0 %
14:00		14°	0 mm	Light breeze, 2 m/s from east-northeast	1019 hPa	66 %	8°	0 %	0 %	0 %	0 %	0 %
15:00		14°	0 mm	Light breeze, 2 m/s from east-northeast	1019 hPa	66 %	8°	0 %	0 %	0 %	0 %	0 %
16:00		14°	0 mm	Light breeze, 2 m/s from east-northeast	1019 hPa	67 %	8°	7 %	0 %	0 %	0 %	7 %
17:00		14°	0 mm	Light breeze, 3 m/s from east	1018 hPa	69 %	8°	5 %	0 %	0 %	0 %	5 %
18:00		12°	0 mm	Gentle breeze, 4 m/s from east	1018 hPa	69 %	7°	0 %	0 %	0 %	0 %	0 %
19:00		11°	0 mm	Gentle breeze, 4 m/s from east-southeast	1018 hPa	70 %	6°	0 %	0 %	0 %	0 %	0 %
20:00		10°	0 mm	Gentle breeze, 4 m/s from east-southeast	1018 hPa	71 %	5°	5 %	0 %	0 %	0 %	5 %
21:00		9°	0 mm	Gentle breeze, 4 m/s from east-southeast	1018 hPa	69 %	3°	21 %	0 %	0 %	0 %	21 %
22:00		8°	0 mm	Gentle breeze, 4 m/s from east-southeast	1019 hPa	67 %	2°	17 %	0 %	0 %	0 %	17 %
23:00		6°	0 mm	Gentle breeze, 4 m/s from east-southeast	1019 hPa	66 %	1°	8 %	0 %	0 %	0 %	8 %

#### Detailed forecast May 22, 2019

Time	Weather	Temp.	Precipitation	Wind	Pressure	Humidity	Dew point	Cloud cover				
								Total	Fog	Low clouds	Middle clouds	High clouds

Time	Weather	Temp.	Precipitation	Wind	Pressure	Humidity	Dew point	Total	Fog	Cloud cover	Middle clouds	High clouds
								Total	Fog	Low clouds	Middle clouds	High clouds
00:00		5°	0 mm	 Light breeze, 3 m/s from east-southeast	1019 hPa	67 %	0°	0 %	0 %	0 %	0 %	0 %
01:00		5°	0 mm	 Light breeze, 3 m/s from east-southeast	1019 hPa	67 %	-1°	0 %	0 %	0 %	0 %	0 %
02:00		4°	0 mm	 Light breeze, 3 m/s from east-southeast	1019 hPa	68 %	-1°	1 %	0 %	0 %	0 %	0 %
03:00		4°	0 mm	 Light breeze, 3 m/s from east	1019 hPa	69 %	-1°	2 % 	0 %	1 %	0 %	0 %
04:00		4°	0 mm	 Gentle breeze, 5 m/s from east-northeast	1019 hPa	72 %	-1°	2 % 	0 %	1 %	0 %	0 %
05:00		4°	0 mm	 Moderate breeze, 7 m/s from east-northeast	1020 hPa	74 %	0°	2 % 	0 %	1 %	0 %	0 %
06:00		4°	0 mm	 Fresh breeze, 8 m/s from east-northeast	1020 hPa	72 %	-1°	1 %	0 %	1 %	0 %	0 %
07:00		4°	0 mm	 Fresh breeze, 9 m/s from east-northeast	1020 hPa	70 %	-1°	1 %	0 %	1 %	0 %	0 %
08:00		5°	0 mm	 Fresh breeze, 9 m/s from northeast	1020 hPa	68 %	-1°	0 %	0 %	0 %	0 %	0 %
09:00		5°	0 mm	 Fresh breeze, 9 m/s from northeast	1021 hPa	66 %	-1°	0 %	0 %	0 %	0 %	0 %
10:00		5°	0 mm	 Fresh breeze, 10 m/s from northeast	1021 hPa	63 %	-1°	0 %	0 %	0 %	0 %	0 %
11:00		6°	0 mm	 Fresh breeze, 10 m/s from northeast	1021 hPa	59 %	-2°	2 % 	0 %	2 % 	0 %	0 %

Detailed forecast May 24, 2019

Time	Weather	Temp.	Precipitation	Wind	Pressure	Humidity	Dew point	Cloud cover				
								Total	Fog	Low clouds	Middle clouds	High clouds
15:00		11°	0 mm	Light breeze, 3 m/s from northeast	1011 hPa	61 %	4°	73 %	0 %	50 %	0 %	50 %
16:00		10°	0 mm	Light breeze, 3 m/s from northeast	1010 hPa	62 %	4°	56 %	0 %	44 %	0 %	27 %
17:00		10°	0 mm	Gentle breeze, 4 m/s from northeast	1010 hPa	64 %	3°	42 %	0 %	34 %	0 %	13 %
18:00		9°	0 mm	Gentle breeze, 5 m/s from northeast	1010 hPa	65 %	3°	38 %	0 %	36 %	0 %	3 %
19:00		8°	0 mm	Gentle breeze, 5 m/s from northeast	1010 hPa	66 %	2°	59 %	0 %	59 %	0 %	0 %
20:00		7°	0 mm	Gentle breeze, 5 m/s from northeast	1010 hPa	68 %	2°	75 %	0 %	75 %	3 %	0 %
21:00		6°	0 mm	Gentle breeze, 4 m/s from northeast	1010 hPa	71 %	1°	68 %	0 %	68 %	3 %	0 %
22:00		5°	0 mm	Gentle breeze, 4 m/s from northeast	1010 hPa	74 %	1°	49 %	0 %	49 %	0 %	0 %
23:00		4°	0 mm	Gentle breeze, 4 m/s from northeast	1010 hPa	76 %	0°	42 %	0 %	42 %	0 %	0 %

Detailed forecast May 25, 2019

Time	Weather	Temp.	Precipitation	Wind	Pressure	Humidity	Dew point	Cloud cover				
								Total	Fog	Low clouds	Middle clouds	High clouds
00:00		3°	0 mm	Gentle breeze, 4 m/s from east-northeast	1010 hPa	78 %	-1°	51 %	0 %	51 %	0 %	0 %

Time	Weather	Temp.	Precipitation	Wind	Pressure	Humid- ity	Dew point	Cloud cover				
								Total	Fog	Low clouds	Middle clouds	High clouds
01:00		3°	0 mm	Gentle breeze, 4 m/s from east-northeast	1010 hPa	79 %	-1°	58 %	0 %	58 %	0 %	0 %
02:00		2°	0 mm	Gentle breeze, 4 m/s from east-northeast	1010 hPa	80 %	-1°	64 %	0 %	64 %	0 %	0 %
03:00		2°	0 mm	Gentle breeze, 4 m/s from east-northeast	1010 hPa	81 %	-1°	63 %	0 %	63 %	0 %	0 %
04:00		2°	0 mm	Gentle breeze, 4 m/s from northeast	1010 hPa	80 %	-1°	60 %	0 %	60 %	0 %	0 %
05:00		3°	0 mm	Gentle breeze, 4 m/s from northeast	1010 hPa	77 %	-1°	54 %	0 %	53 %	0 %	0 %
06:00		4°	0 mm	Gentle breeze, 4 m/s from northeast	1010 hPa	73 %	-1°	54 %	0 %	54 %	0 %	0 %
07:00		4°	0 mm	Gentle breeze, 4 m/s from northeast	1010 hPa	70 %	-1°	55 %	0 %	55 %	0 %	0 %
08:00		5°	0 mm	Gentle breeze, 4 m/s from north-northeast	1009 hPa	67 %	-1°	51 %	0 %	51 %	0 %	0 %
09:00		5°	0 mm	Gentle breeze, 4 m/s from north-northeast	1009 hPa	66 %	0°	49 %	0 %	49 %	0 %	0 %
10:00		6°	0 mm	Gentle breeze, 4 m/s from north-northeast	1009 hPa	63 %	-1°	48 %	0 %	48 %	0 %	0 %
11:00		6°	0 mm	Gentle breeze, 4 m/s from north	1009 hPa	61 %	-1°	51 %	0 %	51 %	0 %	0 %
12:00		7°	0 mm	Gentle breeze, 4 m/s from north	1009 hPa	60 %	-1°	51 %	0 %	51 %	0 %	0 %
13:00		7°	0 mm	Light breeze, 3 m/s from north	1008 hPa	59 %	0°	51 %	0 %	51 %	0 %	0 %
14:00		7°	0 mm	Light breeze, 3 m/s from north	1008 hPa	59 %	0°	60 %	0 %	59 %	0 %	0 %
15:00		7°	0 mm	Light breeze, 3 m/s from north-northeast	1008 hPa	59 %	0°	66 %	0 %	66 %	0 %	0 %
16:00		7°	0 mm	Light breeze, 3 m/s from north	1007 hPa	63 %	0°	73 %	0 %	73 %	0 %	0 %
17:00		6°	0 mm	Gentle breeze, 4 m/s from north	1007 hPa	71 %	1°	84 %	0 %	84 %	0 %	0 %
18:00		6°	0 mm	Light breeze, 3 m/s from north	1006 hPa	66 %	0°	89 %	0 %	89 %	0 %	0 %
19:00		5°	0 mm	Light breeze, 3 m/s from north-northwest	1006 hPa	67 %	0°	82 %	0 %	82 %	0 %	0 %
20:00		5°	0 mm	Light breeze, 3 m/s from north-northwest	1005 hPa	67 %	-1°	83 %	0 %	83 %	0 %	3 %
21:00		4°	0 mm	Light breeze, 2 m/s from north	1005 hPa	69 %	-1°	86 %	0 %	84 %	0 %	7 %
22:00		4°	0 mm	Light breeze, 2 m/s from north-northwest	1005 hPa	73 %	-1°	88 %	0 %	85 %	0 %	12 %
23:00		3°	0 mm	Light air, 1 m/s from north	1005 hPa	77 %	0°	84 %	0 %	84 %	0 %	7 %

#### Detailed forecast May 26, 2019

Time	Weather	Temp.	Precipitation	Wind	Pressure	Humid- ity	Dew point	Cloud cover				
								Total	Fog	Low clouds	Middle clouds	High clouds

Time	Weather	Temp.	Precipitation	Wind	Pressure	Humidity	Dew point	Total	Fog	Cloud cover	Middle clouds	High clouds
								Total	Fog	Low clouds	Middle clouds	High clouds
00:00		2°	0 mm	↙ Light air, 1 m/s from southeast	1005 hPa	82 %	0°	78 %	0 %	77 %	0 %	1 %
01:00		2°	0 mm	↙ Light breeze, 2 m/s from southeast	1004 hPa	82 %	-1°	71 %	0 %	68 %	2 %	4 %
02:00		1°	0 mm	↙ Light breeze, 3 m/s from southeast	1003 hPa	81 %	-2°	73 %	0 %	57 %	28 %	23 %
03:00		1°	0 mm	↙ Light breeze, 3 m/s from southeast	1003 hPa	81 %	-2°	92 %	0 %	53 %	71 %	45 %
04:00		2°	0 mm	↙ Light breeze, 2 m/s from south-southeast	1002 hPa	78 %	-2°	90 %	0 %	67 %	54 %	20 %
05:00		2°	0 – 0,1 mm	↖ Light air, 1 m/s from south-southwest	1002 hPa	77 %	-1°	81 %	0 %	78 %	18 %	0 %
06:00		3°	0 – 0,3 mm	↖ Light breeze, 3 m/s from south-southwest	1001 hPa	82 %	0°	94 %	0 %	94 %	26 %	0 %
07:00		3°	0 – 0,3 mm	↖ Light breeze, 3 m/s from southwest	1001 hPa	84 %	1°	87 %	5 %	82 %	36 %	0 %
08:00		2°	0 – 0,3 mm	↖ Light breeze, 3 m/s from southwest	1001 hPa	94 %	1°	65 %	0 %	60 %	19 %	0 %
09:00		3°	0 – 0,3 mm	↖ Light breeze, 2 m/s from south-southwest	1001 hPa	84 %	1°	78 %	0 %	77 %	41 %	0 %
10:00		4°	0 – 0,4 mm	↖ Light breeze, 3 m/s from west-southwest	1001 hPa	74 %	0°	87 %	3 %	83 %	38 %	0 %
11:00		2°	0 – 0,3 mm	↙ Light air, 1 m/s from northwest	1001 hPa	94 %	1°	87 %	0 %	85 %	25 %	0 %
12:00		4°	0 – 0,1 mm	↙ Calm, 0 m/s from north	1001 hPa	82 %	1°	85 %	0 %	85 %	8 %	0 %
13:00		4°	0 – 0,1 mm	↙ Light breeze, 3 m/s from west-northwest	1001 hPa	76 %	0°	79 %	0 %	79 %	0 %	0 %

**Detailed forecast May 28, 2019**

Time	Weather	Temp.	Precipitation	Wind	Pressure	Humidity %	Dew point	Cloud cover				
								Total	Fog	Low clouds	Middle clouds	High clouds
11:00		13°	0 mm	Light air, 1 m/s from north-northwest	1004 hPa	64 %	6°	1 %	0 %	0 %	0 %	1 %
12:00		13°	0 mm	Calm, 0 m/s	1004 hPa	61 %	6°	10 % ■	0 %	0 %	0 %	10 % ■
13:00		14°	0 mm	Light breeze, 2 m/s from south-southeast	1004 hPa	58 %	6°	74 % ■	0 %	4 % 	31 % ■	68 % ■
14:00		15°	0 mm	Light breeze, 3 m/s from south-southeast	1005 hPa	56 %	6°	95 % ■	0 %	8 % ■	70 % ■	84 % ■
15:00		15°	0 mm	Gentle breeze, 4 m/s from southeast	1005 hPa	60 %	7°	95 % ■	0 %	2 % 	52 % ■	90 % ■
16:00		14°	0 mm	Light breeze, 3 m/s from southeast	1005 hPa	62 %	7°	99 % ■	0 %	4 % 	76 % ■	97 % ■
17:00		14°	0 mm	Light breeze, 3 m/s from southeast	1005 hPa	64 %	8°	100 % ■	0 %	16 % ■	97 % ■	100 % ■
18:00		13°	0 – 0,1 mm	Gentle breeze, 4 m/s from southeast	1005 hPa	70 %	8°	100 % ■	0 %	34 % ■	98 % ■	100 % ■
19:00		12°	0 – 0,2 mm	Gentle breeze, 4 m/s from southeast	1005 hPa	72 %	7°	100 % ■	0 %	45 % ■	95 % ■	100 % ■
20:00		10°	0 – 0,2 mm	Gentle breeze, 5 m/s from southeast	1006 hPa	77 %	7°	100 % ■	0 %	62 % ■	94 % ■	100 % ■
21:00		10°	0,1 – 0,3 mm	Gentle breeze, 5 m/s from southeast	1006 hPa	77 %	6°	100 % ■	0 %	54 % ■	92 % ■	100 % ■
22:00		9°	0 – 0,2 mm	Gentle breeze, 4 m/s from southeast	1006 hPa	81 %	6°	100 % ■	0 %	58 % ■	96 % ■	99 % ■

Time	Weather	Temp.	Precipitation	Wind	Pressure	Humidity	Dew point	Cloud cover				
								Total	Fog	Low clouds	Middle clouds	High clouds
23:00		9°	0.3 – 0.9 mm	Light breeze, 3 m/s from southeast	1006 hPa	81 %	6°	100 %	0 %	84 %	100 %	92 %

### Detailed forecast May 29, 2019

Time	Weather	Temp.	Precipitation	Wind	Pressure	Humidity	Dew point	Cloud cover				
								Total	Fog	Low clouds	Middle clouds	High clouds
00:00		8°	0.6 – 1.1 mm	Light breeze, 3 m/s from east-southeast	1006 hPa	86 %	6°	100 %	0 %	87 %	100 %	93 %
01:00		8°	0.6 – 1.0 mm	Light breeze, 3 m/s from south-southeast	1006 hPa	86 %	6°	100 %	0 %	88 %	98 %	89 %
02:00		7°	0.2 – 0.5 mm	Light breeze, 2 m/s from east-southeast	1006 hPa	87 %	5°	100 %	0 %	90 %	96 %	86 %
03:00		7°	0.2 – 0.4 mm	Light breeze, 2 m/s from east-southeast	1005 hPa	86 %	5°	100 %	0 %	94 %	96 %	84 %
04:00		8°	0.1 – 0.3 mm	Light breeze, 2 m/s from southeast	1005 hPa	87 %	5°	99 %	0 %	84 %	80 %	55 %
05:00		8°	0 – 0.2 mm	Light breeze, 2 m/s from south-southeast	1005 hPa	88 %	6°	98 %	0 %	75 %	86 %	46 %
06:00		8°	0 – 0.3 mm	Light air, 1 m/s from southwest	1006 hPa	91 %	7°	77 %	1 %	55 %	40 %	5 %
07:00		9°	0 mm	Light air, 1 m/s from southwest	1006 hPa	95 %	8°	62 %	0 %	58 %	4 %	0 %
08:00		10°	0 mm	Light breeze, 3 m/s from southwest	1006 hPa	90 %	8°	75 %	0 %	70 %	6 %	1 %
09:00		10°	0 mm	Light breeze, 2 m/s from west	1006 hPa	87 %	8°	90 %	0 %	69 %	43 %	50 %
10:00		10°	0 mm	Light breeze, 2 m/s from west-northwest	1006 hPa	86 %	8°	99 %	0 %	86 %	64 %	66 %
11:00		10°	0 – 0.2 mm	Light air, 1 m/s from north-northwest	1005 hPa	82 %	7°	100 %	0 %	98 %	86 %	0 %
12:00		10°	0.1 – 0.2 mm	Light breeze, 3 m/s from north-northeast	1005 hPa	86 %	8°	91 %	0 %	82 %	59 %	0 %
13:00		10°	0 mm	Light breeze, 3 m/s from north-northeast	1005 hPa	87 %	8°	64 %	0 %	59 %	15 %	0 %
14:00		12°	0 mm	Light breeze, 3 m/s from northeast	1004 hPa	83 %	9°	60 %	0 %	58 %	8 %	0 %
15:00		13°	0 mm	Light breeze, 3 m/s from east	1004 hPa	75 %	8°	42 %	0 %	41 %	1 %	0 %
16:00		13°	0 mm	Light breeze, 3 m/s from south-southeast	1003 hPa	70 %	8°	12 %	0 %	5 %	6 %	2 %
17:00		14°	0 mm	Light breeze, 3 m/s from south-southeast	1002 hPa	70 %	9°	41 %	0 %	26 %	20 %	2 %
18:00		14°	0 mm	Gentle breeze, 4 m/s from southeast	1002 hPa	68 %	8°	43 %	0 %	11 %	34 %	3 %
19:00		13°	0 mm	Light breeze, 2 m/s from southeast	1001 hPa	74 %	9°	79 %	0 %	16 %	75 %	20 %
20:00		12°	0 – 0.1 mm	Gentle breeze, 4 m/s from east-southeast	1000 hPa	75 %	7°	92 %	0 %	63 %	88 %	2 %



Time	Weather	Temp.	Precipitation	Wind	Pressure	Humidity	Dew point	Cloud cover				
								Total	Fog	Low clouds	Middle clouds	High clouds
21:00		11°	0–0.3 mm	Gentle breeze, 4 m/s from east-southeast	1000 hPa	78 %	7°	92 %	0 %	78 %	76 %	0 %
22:00		10°	0–0.2 mm	Light breeze, 2 m/s from east-southeast	999 hPa	83 %	7°	91 %	0 %	62 %	84 %	0 %
23:00		9°	0–0.1 mm	Light breeze, 3 m/s from east-southeast	999 hPa	83 %	6°	86 %	0 %	55 %	70 %	0 %

#### Detailed forecast May 30, 2019

Time	Weather	Temp.	Precipitation	Wind	Pressure	Humidity	Dew point	Cloud cover				
								Total	Fog	Low clouds	Middle clouds	High clouds
00:00		8°	0 mm	Light breeze, 2 m/s from east-southeast	998 hPa	82 %	6°	99 %	0 %	52 %	97 %	15 %
01:00		8°	0–0.2 mm	Light breeze, 3 m/s from east-southeast	998 hPa	82 %	5°	96 %	0 %	53 %	91 %	1 %
02:00		7°	0–0.2 mm	Light air, 1 m/s from east	997 hPa	85 %	5°	99 %	0 %	96 %	91 %	3 %
03:00		7°	0.1–0.4 mm	Light breeze, 2 m/s from southeast	997 hPa	84 %	5°	100 %	0 %	100 %	99 %	3 %
04:00		7°	0.5–1.1 mm	Light breeze, 2 m/s from south-southwest	997 hPa	92 %	6°	100 %	1 %	100 %	100 %	50 %
05:00		7°	0.7–1.4 mm	Gentle breeze, 4 m/s from south-southwest	997 hPa	96 %	7°	100 %	14 %	100 %	99 %	100 %
06:00		6°	0.4–1.2 mm	Moderate breeze, 6 m/s from southwest	997 hPa	99 %	6°	100 %	1 %	100 %	100 %	97 %
07:00		6°	0.3–1.2 mm	Moderate breeze, 6 m/s from south-southwest	998 hPa	95 %	5°	100 %	1 %	100 %	100 %	100 %
08:00		5°	0.5–1.4 mm	Moderate breeze, 7 m/s from south-southwest	998 hPa	95 %	5°	100 %	1 %	98 %	100 %	100 %
09:00		6°	0.8–2.0 mm	Moderate breeze, 7 m/s from south-southwest	998 hPa	95 %	5°	100 %	2 %	98 %	100 %	100 %

## APPENDIX III

Raw data extracted to a text document

date;time; bme0.hum; bme0.press; bme0.temp;bme1.hum; bme1.press; bme1.temp;bme2.hum;  
bme2.press; bme2.temp;bme3.hum; bme3.press;  
bme3.temp;ligh0.uv;light0.ir;light0.vis;ligh1.uv;light1.ir;light1.vis ;si7021.temp; vbat;vcc

04.07.2019;10:08:58;45.48;100639.10;-41.87;35.86;100263.30;-41.52;20.15;100250.66;-  
38.82;42.31;100170.73;-40.84;0.04;249;263;0.00;0;0;-23.24;3.76;3.40

04.07.2019;10:08:59;45.51;100625.54;-41.87;35.85;100278.72;-41.52;20.15;100247.80;-  
38.82;42.32;100183.98;-40.83;0.04;250;265;0.00;0;0;-21.21;3.43;3.40

04.07.2019;10:09:00;45.48;100633.03;-41.87;35.88;100280.20;-41.52;20.15;100277.76;-  
38.82;42.34;100192.97;-40.85;0.03;252;263;0.00;0;0;-16.07;3.39;3.40

04.07.2019;10:09:01;45.50;100648.34;-41.88;35.85;100250.41;-41.53;20.16;100263.94;-  
38.84;42.35;100164.98;-40.85;0.03;249;263;0.00;0;0;-13.08;3.37;3.40

04.07.2019;10:09:02;45.49;100648.95;-41.89;35.89;100265.38;-41.53;20.16;100252.19;-  
38.85;42.37;100189.64;-40.86;0.03;251;263;0.00;0;0;-10.96;3.34;3.40

04.07.2019;10:09:03;45.55;100627.19;-41.89;35.89;100276.65;-41.54;20.16;100239.58;-  
38.86;42.38;100159.27;-40.86;0.04;251;264;0.00;0;0;-9.34;3.35;3.40

04.07.2019;10:09:04;45.51;100627.78;-41.90;36.03;100260.05;-41.54;20.16;100237.12;-  
38.86;42.39;100181.92;-40.87;0.03;250;263;0.00;0;0;-8.04;3.34;3.40

04.07.2019;10:09:05;45.53;100628.97;-41.90;35.89;100251.19;-41.55;20.17;100241.98;-  
38.86;42.40;100189.47;-40.87;0.03;250;263;0.00;0;0;-6.93;3.34;3.40

04.07.2019;10:09:06;45.49;100625.52;-41.91;36.05;100274.02;-41.56;20.17;100250.06;-  
38.87;42.41;100151.05;-40.88;0.05;250;266;0.00;0;0;-5.94;3.33;3.40

04.07.2019;10:09:07;45.54;100642.06;-41.92;35.89;100267.64;-41.56;20.17;100254.89;-  
38.88;42.42;100178.59;-40.88;0.04;250;265;0.00;0;0;-5.07;3.33;3.40

04.07.2019;10:09:08;45.52;100647.12;-41.92;35.92;100266.02;-41.56;20.18;100244.31;-  
38.89;42.44;100190.57;-40.88;0.04;252;265;0.00;0;0;-4.28;3.33;3.40

04.07.2019;10:09:09;45.58;100641.47;-41.93;35.99;100262.31;-41.57;20.19;100257.66;-  
38.90;42.45;100163.72;-40.89;0.05;250;266;0.00;0;0;-3.58;3.32;3.40

04.07.2019;10:09:10;45.57;100640.54;-41.93;36.01;100269.28;-41.58;20.19;100260.47;-  
38.90;42.46;100181.26;-40.89;0.03;249;262;0.00;0;0;-2.95;3.32;3.40

04.07.2019;10:09:11;45.58;100623.40;-41.94;36.01;100274.47;-41.57;20.19;100253.16;-  
38.90;42.48;100178.09;-40.89;0.04;251;264;0.00;0;0;-2.32;3.31;3.40

# APPENDIX IV

Examples of 'heated temperature' behaviour in field tests

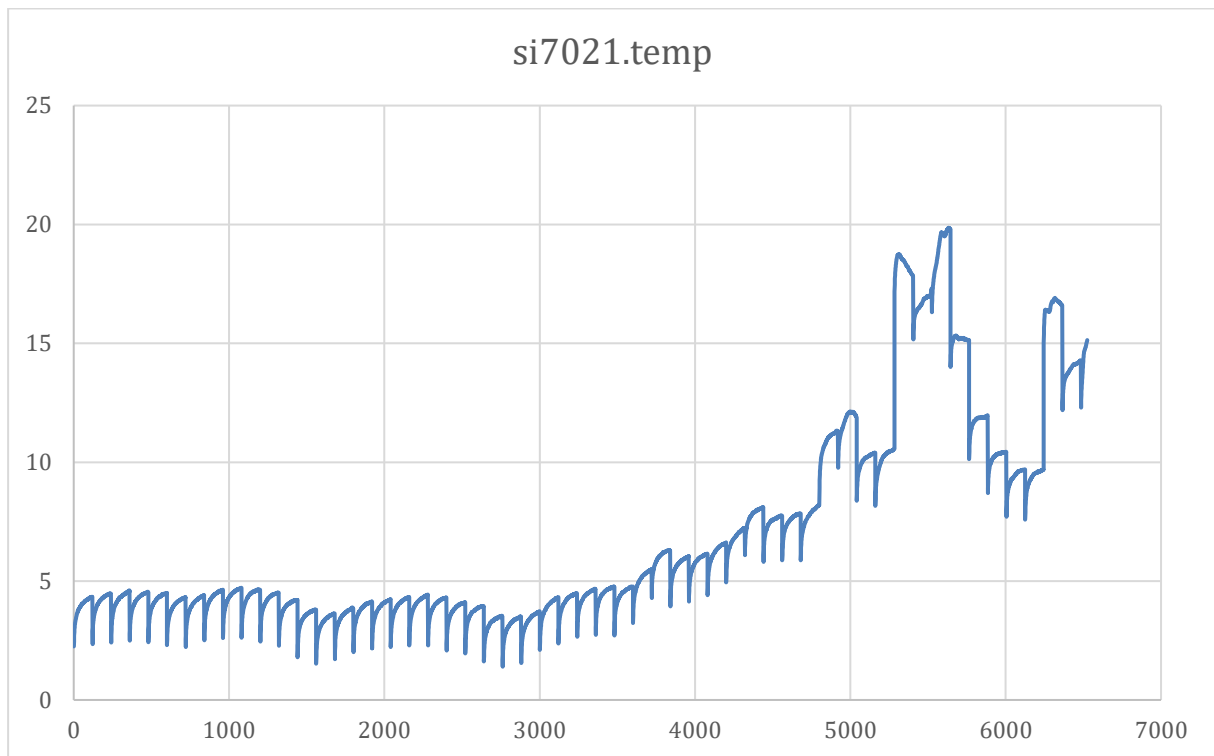
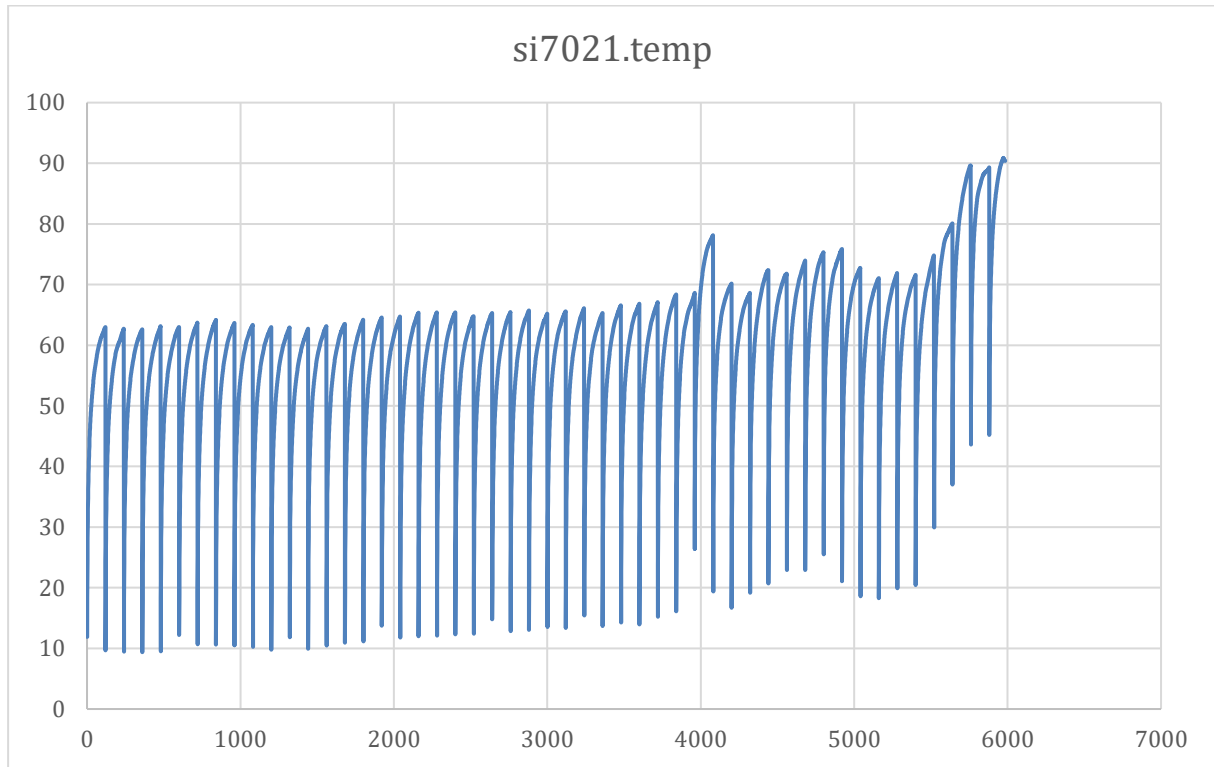

si7021.temp

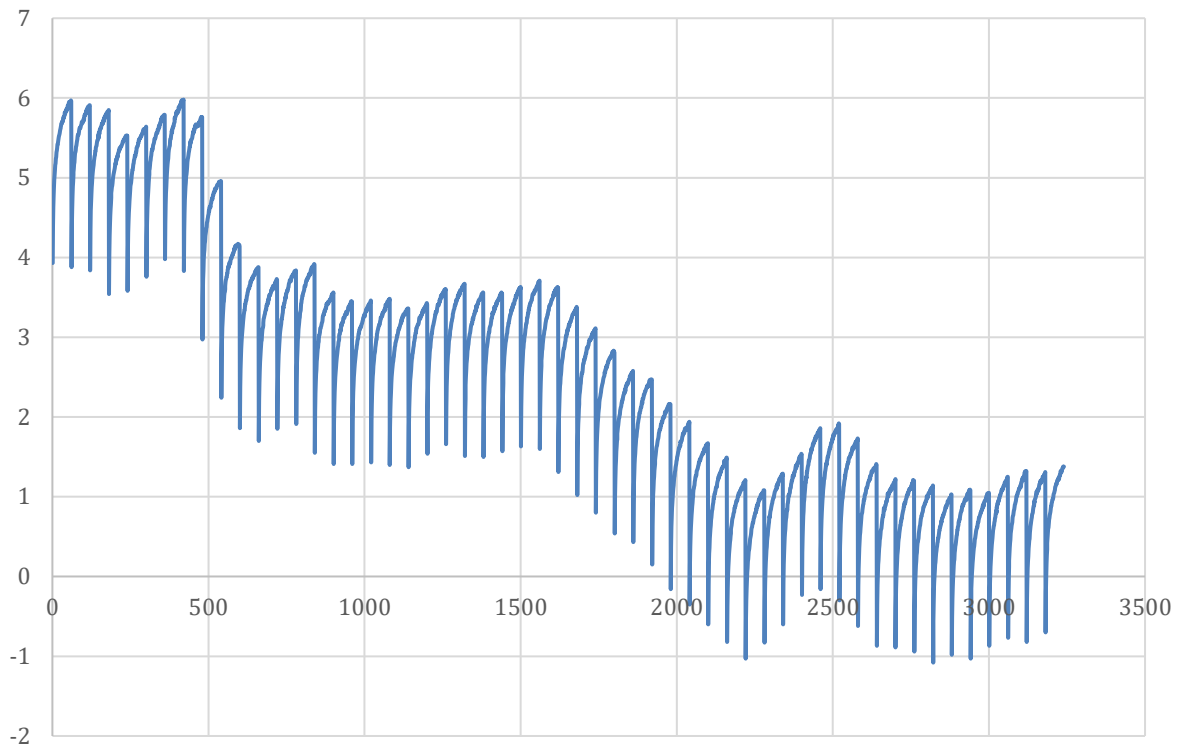

si7021.temp

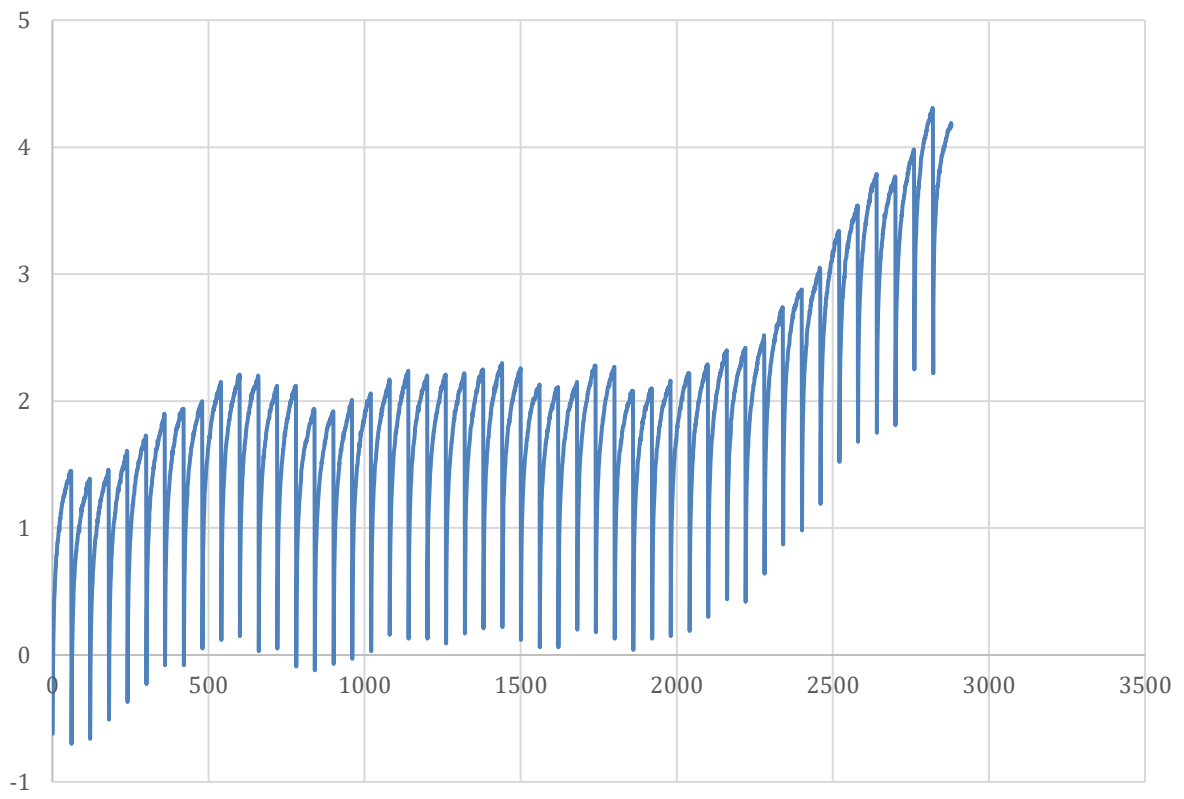

Examples of 'heated temperature' behaviour in lab tests

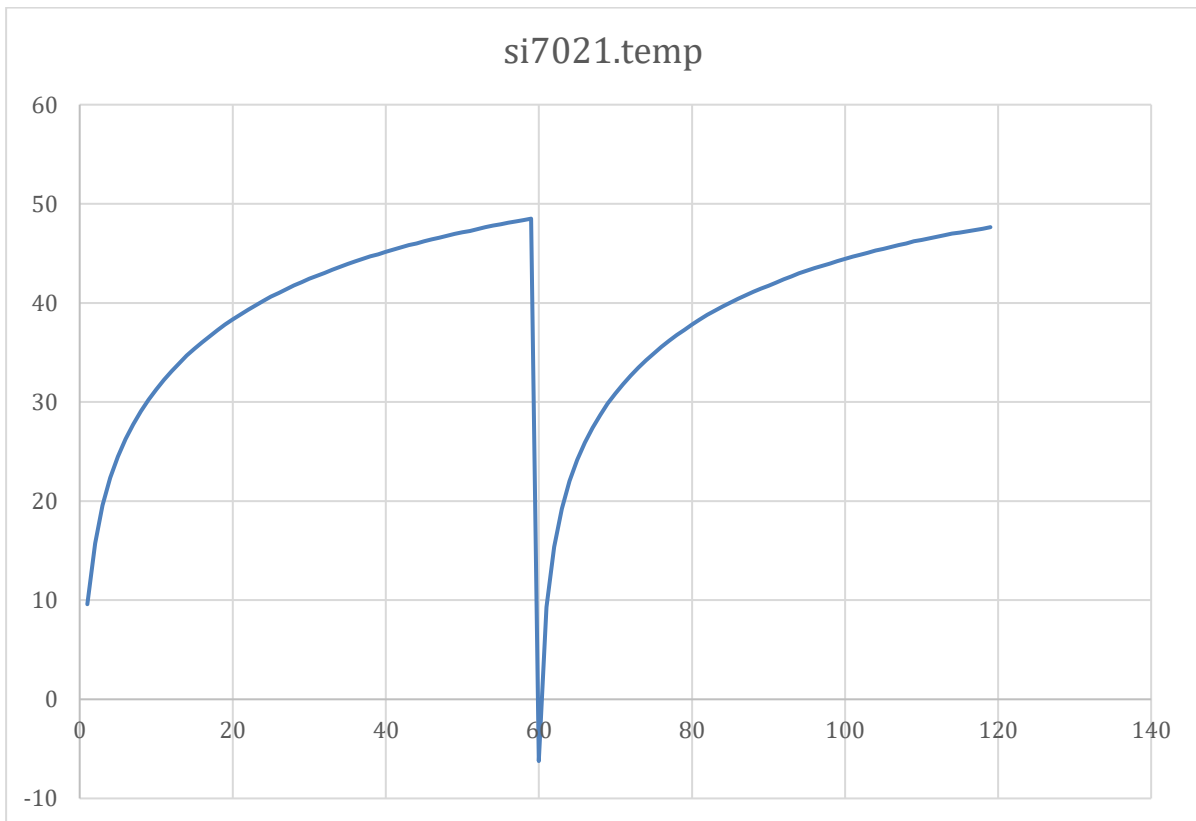
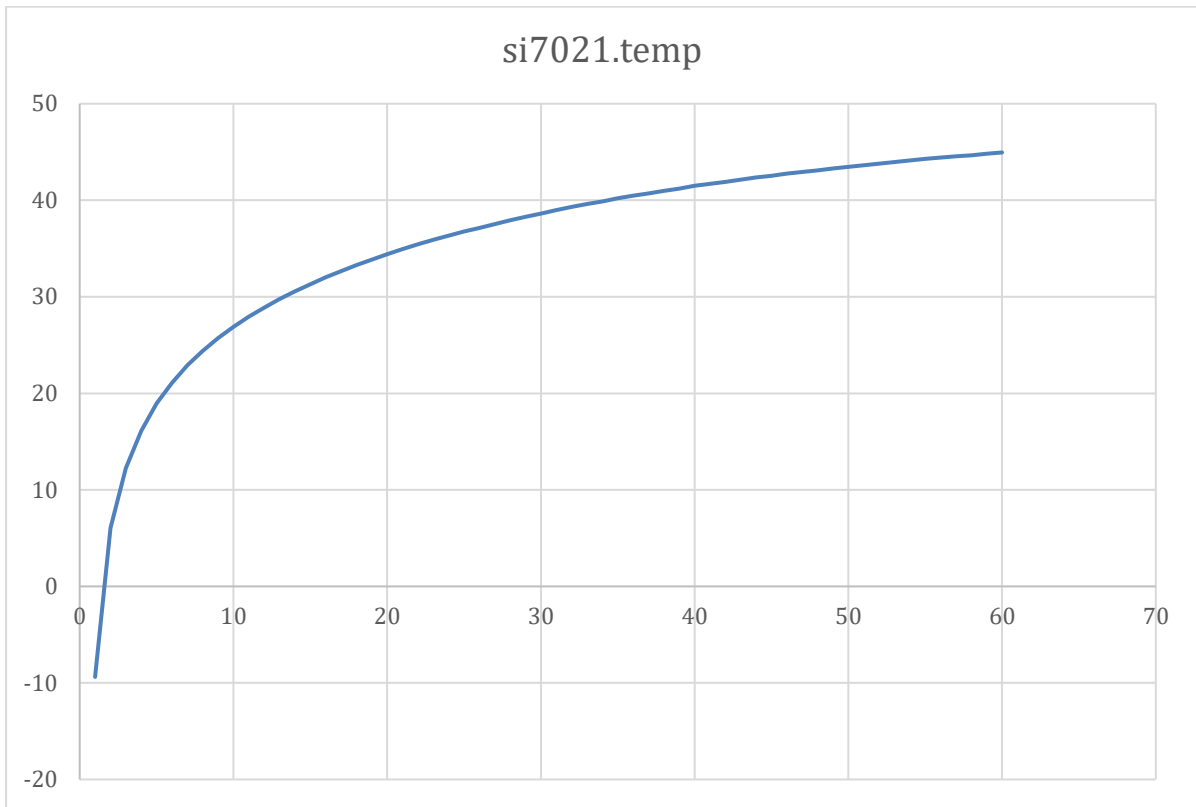

si7021.temp

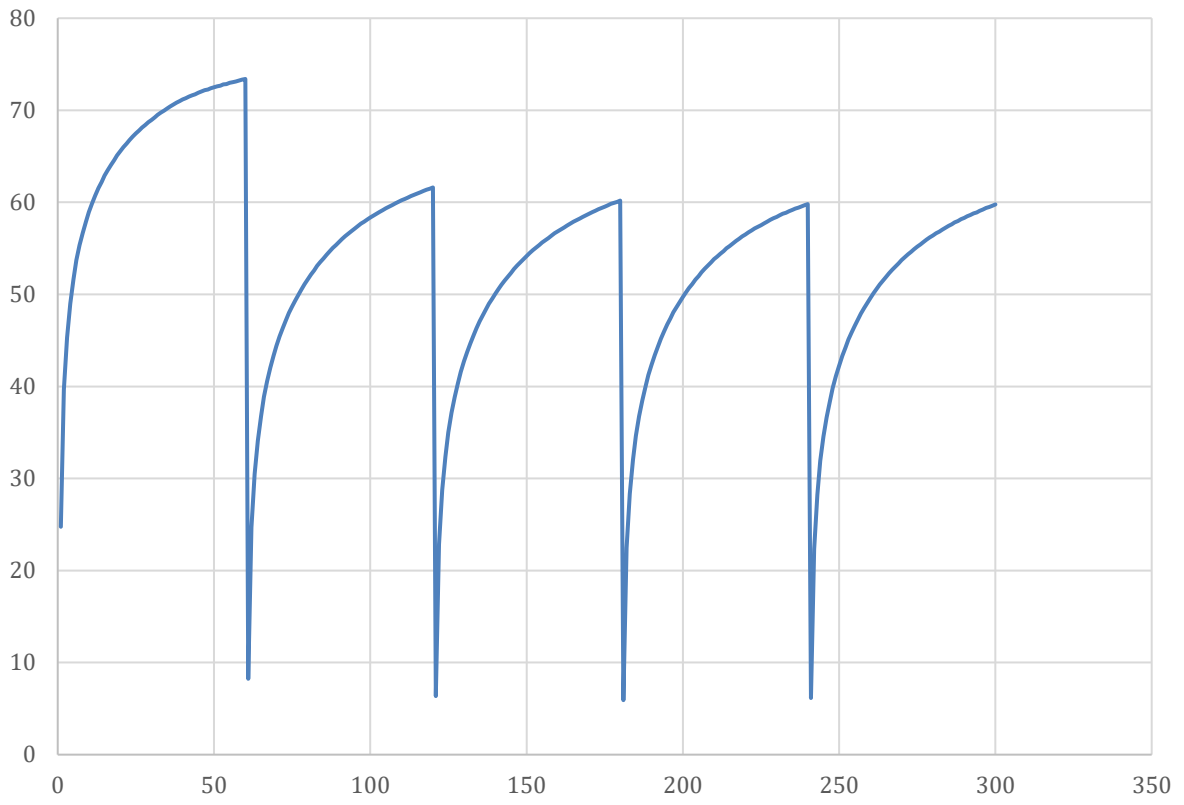

si7021.temp

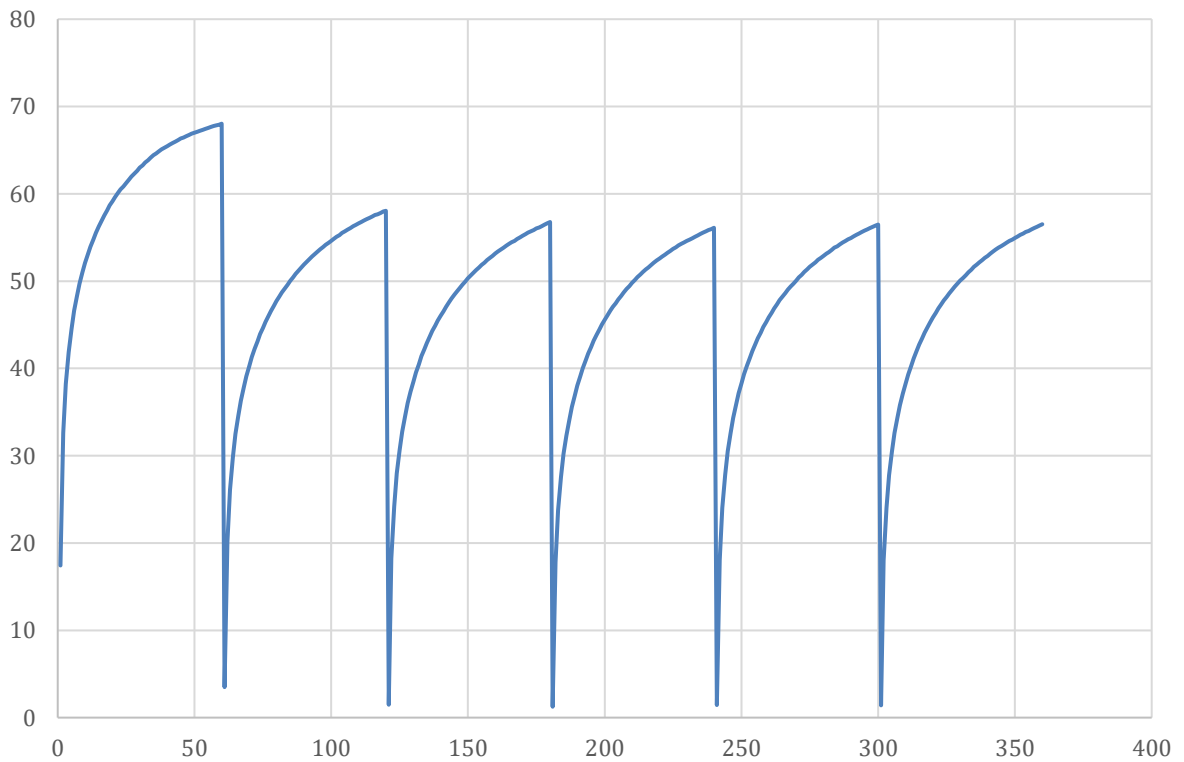

# APPENDIX V

The pressure sensor sensitivity analysis to wind blown directly to each of three sensors

STILL				CENTER				INSIDE				SIDE				INSIDE				BLACK			
0	1	2	3	0	1	2	3	0	1	2	3	0	1	2	3	0	1	2	3				
100343.24	100301.3	100214.98	100242.92	100382	100317.73	100226.78	100251.33	100363	100327	100229.23	100253.98	100346.2	100302.5	100214.6	100272.2								
100350.33	100301.8	100218.87	100242.92	100382	100308.91	100230.84	100256.67	100355.1	100328	100221.12	100256.14	100346.7	100295.5	100217.3	100268.2								
100348.56	100299.9	100214.24	100245.47	100380	100312.45	100233.17	100249.2	100359.1	100330	100229.23	100255.31	100343.6	100303	100215.1	100266.5								
100347.71	100299.9	100216	100248.14	100377	100305.03	100229.11	100248.37	100357.2	100328	100233.28	100257.98	100348	100299	100213.8	100268.3								
100346.38	100303.4	100212.73	100246.39	100378	100309.89	100228.7	100261.82	100361.7	100332	100228.61	100255.72	100343.6	100301.7	100216.1	100268.3								
100346.81	100299.4	100218.54	100241.05	100380	100305.5	100227.36	100251.13	100356.8	100327	100227.88	100258.39	100348.9	100303.5	100216.5	100269.8								
100341.53	100297.6	100218.38	100241.88	100381	100314.28	100232.77	100250.34	100357.7	100330	100231.52	100259.31	100344.5	100302.6	100213.4	100269.3								
100347.28	100302.9	100213.34	100241.46	100378	100310.83	100231.41	100249.92	100355	100334	100228.61	100257.56	100343.1	100298.7	100222	100258.7								
100349.52	100305.5	100216.86	100245.06	100378	100313.48	100230.62	100253.11	100363	100328	100226.52	100256.77	100345.8	100299.6	100215.3	100261.8								
100347	100298	100217	100244	100374	100312	100231	100250	100363	100333	100225	100258	100348	100301	100212	100269								
100352	100301	100215	100242	100377	100314	100234	100258	100355	100328	100224	100256	100342	100297	100222	100265								
100351	100296	100210	100241	100383	100317	100237	100257	100353	100329	100228	100252	100343	100302	100215	100265								
100345	100301	100220	100242	100390	100317	100237	100261	100352	100325	100224	100245	100346	100306	100216	100256								
100343	100301	100215	100247	100385	100314	100238	100258	100354	100333	100226	100256	100347	100297	100214	100261								
100344	100300	100216	100242	100393	100319	100239	100254	100354	100331	100227	100249	100343	100299	100212	100271								
100345	100303	100215	100242	100390	100313	100237	100260	100352	100326	100221	100250	100351	100297	100217	100268								
100344	100300	100216	100247	100385	100312	100227	100255	100352	100327	100221	100247	100351	100299	100218	100269								
100347	100296	100214	100241	100388	100315	100235	100250	100346	100329	100215	100249	100348	100300	100217	100269								
100350	100300	100221	100241	100388	100312	100227	100255	100352	100322	100224	100245	100354	100303	100219	100270								
100350	100301	100215	100241	100386	100310	100232	100249	100352	100333	100216	100247	100348	100306	100217	100273								
100351	100301	100213	100247	100384	100310	100235	100250	100354	100328	100214	100250	100353	100306	100215	100269								
100345	100304	100216	100249	100382	100310	100230	100252	100353	100326	100217	100245	100355	100308	100220	100273								
100347	100298	100217	100241	100381	100308	100230	100254	100348	100324	100218	100250	100355	100310	100224	100270								
100345	100299	100215	100247	100380	100312	100227	100250	100350	100322	100223	100246	100347	100308	100220	100270								
100350	100301	100213	100244	100384	100308	100227	100252	100349	100324	100222	100247	100353	100307	100225	100272								
100349	100297	100220	100250	100377	100306	100227	100247	100361	100332	100219	100247	100346	100306	100217	100268								
100346	100303	100218	100246	100384	100309	100227	100251	100356	100330	100221	100251	100351	100298	100216	100271								
100345	100303	100220	100246	100383	100310	100228	100252	100352	100319	100222	100250	100345	100302	100217	100264								
100348	100301	100214	100247	100387	100304	100228	100258	100351	100326	100222	100251	100347	100302	100213	100265								
100353	100306	100218	100246	100387	100308	100231	100252	100353	100325	100219	100246	100347	100300	100215	100263								
100350	100305	100220	100246	100386	100311	100226	100249	100347	100325	100218	100248	100343	100299	100219	100264								
100348	100302	100215	100240	100385	100313	100230	100251	100351	100321	100222	100248	100353	100303	100214	100268								
100353	100304	100216	100248	100384	100308	100229	100249	100352	100322	100217	100246	100347	100305	100215	100269								
100354	100310	100226	100251	100378	100309	100223	100249	100358	100318	100220	100249	100352	100302	100217	100270								
100353	100302	100217	100252	100384	100304	100227	100250	100358	100326	100219	100244	100348	100304	100220	100268								
100354	100300	100217	100253	100386	100303	100229	100248	100360	100330	100224	100244	100346	100302	100221	100271								
100353	100300	100221	100250	100383	100306	100225	100252	100355	100330	100222	100248	100347	100302	100216	100265								
100349	100306	100218	100253	100380	100307	100224	100254	100351	100329	100214	100246	100351	100306	100217	100274								
100355	100307	100219	100251	100377	100307	100223	100246	100353	100329	100222	100248	100347	100301	100213	100270								
100356	100304	100220	100252	100381	100307	100224	100247	100356	100337	100223	100242	100345	100303	100216	100266								
100349	100307	100219	100249	100391	100307	100233	100249	100348	100328	100223	100246	100345	100303	100217	100262								
100346	100304	100217	100250	100386	100310	100227	100255	100356	100329	100225	100243	100345	100304	100215	100263								
100354	100306	100222	100253	100389	100311	100227	100256	100353	100336	100227	100250	100352	100301	100218	100270								
100354	100308	100221	100251	100391	100318	100228	100253	100354	100323	100224	100248	100351	100299	100214	100265								
<b>100349</b>	<b>100302</b>	<b>100217</b>	<b>100246</b>	<b>100383</b>	<b>100311</b>	<b>100230</b>	<b>100252</b>	<b>100354</b>	<b>100328</b>	<b>100223</b>	<b>100250</b>	<b>100348</b>	<b>100302</b>	<b>100217</b>	<b>100267</b>								
				34	9	13	6	-23		-7	-2		-7	-26	-6	18							
				<b>max</b>					<b>max</b>				<b>max</b>										
				<b>21.88</b>	<b>ind = 2-3 m/s</b>				<b>24.06</b>	<b>ind = 2-3 m/s</b>				<b>23.64</b>	<b>ind = 2-3 m/s</b>								
				<b>head</b>					<b>head</b>				<b>head</b>										