



Feature Spreading 2.0

A Unified Theory of Assimilation

Peter Jurgec

A thesis submitted for the degree of Philosophiæ Doctor

University of Tromsø
Faculty of Humanities
Center for Advanced Study in Theoretical Linguistics

June 2011

Preface to the Revised Version

This is a revised version of the dissertation that was submitted on August 20, 2010 and defended on January 13, 2011. The revised version has benefited greatly from the comments of the committee members: Laura Downing, Martin Krämer, and Marc van Oostendorp.

For the most part, the revisions are rather minor and limited to typos and wording. Replies to the committee's comments can be found in the main text or in the footnotes.

I have *significantly* modified the following parts:

- Section 3.3.1 contains a new table (58), which makes the locality restrictions in place assimilation clearer.
- Section 4.2.2 makes the concept of strict binary branching more explicit (84).
- Section 4.2.3 now includes a paragraph on recursion in phonology.
- The data in section 4.5.1 are explained in greater detail.
- Section 4.5.2 has a new discussion of triggers in bidirectional assimilation (119)–(120).
- A new section 4.6.2 explains why icy targets are a pattern different from non-iterative spreading.
- Section 5.2.2 now contains an evaluation of several alternative versions of alignment and faithfulness constraints with respect to full and dependent association.
- Section 6.6 has two new tables with the typologies of blockers (Table 6.2) and transparent segments (Table 6.3).
- The definition of agreement constraints in chapter 8 is modified.
- Section 8.4.5 now flashes out the principal differences between transparency and blocking with respect to agreement constraints.

- Section 8.5.5 now outlines the differences between the current approach and Agreement by Correspondence.
- Chapter 9 is entirely rewritten.
- A new section 10.2 is added to highlight the contributions of this dissertation.

This version supersedes the originally submitted version.

Contents

Abbreviations and Symbols	vii
Acknowledgments	ix
1 Introduction	1
I Assimilation as Alignment	7
2 What is assimilation	9
2.1 Basic parameters	9
2.1.1 Spreading feature	11
2.1.2 Targeted structure	14
2.1.3 Domain	17
2.2 Basic analysis	22
2.2.1 Representations	23
2.2.2 Constraints	28
2.3 Summary	39
3 Targets	41
3.1 Introduction	42
3.2 Typology of targets	45
3.2.1 Southern Palestinian Arabic	46
3.2.2 Twi	48
3.2.3 Wolof	53
3.2.4 Alignment revisited	56
3.2.5 Factorial typology	61
3.3 Assimilation and dissimilation	63
3.3.1 Place assimilation	63
3.3.2 Place dissimilation	72
3.4 Morphological targets	77

3.4.1	Lango	77
3.4.2	Dutch	82
3.5	Summary	86
 II Assimilation as Hierarchy		89
4	Icy targets	91
4.1	Introduction	92
4.2	Binary Domains Theory	94
4.2.1	Association in Metrical Theory	95
4.2.2	Formalism	98
4.2.3	Headedness, binarity, and recursion	100
4.2.4	Constraints on heads	102
4.3	Icelandic	105
4.3.1	Data	105
4.3.2	Analysis	109
4.4	Sanskrit	118
4.4.1	Data	118
4.4.2	Analysis	120
4.5	Ikwere	123
4.5.1	Data	124
4.5.2	Analysis	129
4.6	Alternatives	135
4.6.1	Feature domain theories	136
4.6.2	Non-iterativity	139
4.6.3	Positional licensing	142
4.6.4	Sequential Markedness Constraints	145
4.7	Summary	148
5	Transparent segments	151
5.1	Introduction	152
5.2	Binary Domains Theory upgraded	155
5.2.1	Representations	155
5.2.2	Constraints	163
5.2.3	Transparency	180
5.3	Icelandic	182
5.4	C'Lela	185
5.4.1	Data	185
5.4.2	Analysis	186
5.5	Finnish	192

5.5.1	Data	193
5.5.2	Analysis	196
5.6	Summary	199
6	Blockers	201
6.1	Introduction	202
6.2	Blocking in Binary Domains Theory	206
6.2.1	Feature co-occurrence constraints	207
6.2.2	Representations	210
6.3	Southern Palestinian Arabic	211
6.4	Comparing transparency and blocking	216
6.4.1	Wolof	217
6.4.2	Yoruba	220
6.4.3	Factorial typology	227
6.5	Blocking by consonants	231
6.5.1	Vowel harmony	232
6.5.2	Tone spreading	234
6.6	Nasal harmony	238
6.6.1	Blocking	238
6.6.2	Transparency	243
6.6.3	Mòbà	248
6.7	Summary	253
7	Triggers	255
7.1	Introduction	256
7.2	Heads-of-Heads	260
7.2.1	Representations	260
7.2.2	Constraints	262
7.3	Baiyinna Orochen	263
7.3.1	Data	264
7.3.2	Analysis	266
7.4	Nasal harmony	268
7.4.1	Cross-linguistic generalizations	268
7.4.2	Mòbà	269
7.5	Summary	272
III	Assimilation as Interaction	275
8	Parasitic assimilation	277
8.1	Introduction	278

8.2	Agreement	281
8.2.1	Classic Agreement	281
8.2.2	Agreement in BDT	285
8.3	Yowlumne	288
8.4	Rounding harmony	294
8.4.1	Cross-linguistic generalizations	294
8.4.2	Kyrgyz	298
8.4.3	Turkish	300
8.4.4	Kachin Khakass	305
8.4.5	Khalkha Mongolian	308
8.4.6	Yakut	315
8.4.7	The larger picture	319
8.5	Consonant harmony	320
8.5.1	Cross-linguistic generalizations	321
8.5.2	Sibilant harmony	324
8.5.3	Kalasha retroflex harmony	333
8.5.4	Yaka nasal consonant harmony	338
8.5.5	The larger picture	346
8.6	Summary	354
9	Positional effects	357
9.1	Introduction	358
9.2	Positional faithfulness	362
9.3	Hungarian	364
9.4	Rightmost faithfulness	373
9.4.1	Chumash	373
9.4.2	Turkana	383
9.4.3	Tashlhiyt Berber	387
9.5	Root faithfulness	391
9.5.1	Cross-linguistic generalizations	391
9.5.2	Twi	395
9.6	Summary	398
10	Conclusions	401
10.1	Summary	401
10.2	Contributions	404
	References	409

Abbreviations and Symbols

☺	intended winner
☞	harmonically bounded candidate
☒	candidate excluded by Gen
BDT	Binary Domains Theory
f-node	feature node
f-precedence	featural precedence
d-association	dependent association
F	feature head of the feature [f]
<u>F</u>	Head-of-Heads of the feature [f]
◁	f-precedence relation

Acknowledgments

Over the past four years, perhaps the most common question from people that do not know me all that well was why I decided to do another doctorate. The simplest answer would be that I wanted to learn more before I get into the tough, real world. A truer answer would be because this enterprise has been an intense, but ultimately fun experience. I have met many linguists, traveled hundreds of thousands of miles, read many thousands of papers, heard hundreds of talks, gave tens of them, learned a great deal about linguistics, and about phonology in particular.

The good people of Tromsø made all of these things possible. In the first place I should mention my advisors. However, it is impossible to choose who should be mentioned first. The best I can do is: ^{Curt Rice}
^{Bruce Morén-Duolljá}. Both made me think about phonology a lot. Both challenged me in many ways. Both gave me support even with things that they never got paid for. Both spend a lot of time dealing with my crazy ideas. January 2006, when I first met both of them, seems like last week. Sometimes, I wish I could stay in the Arctic for yet another Ph.D. and get to hang out with these two awesome guys. Alternatively, they would move to some warmer place, which would also be kinder to seasonal mood disordered people. I think no one would complain if CASTL relocated to the Canary Islands, for instance.

Speaking of Arctic related challenges, there are many other people that helped me survive the constant cold, rain, absence of daylight, ridiculous prices, and the rarity of quality fruit and vegetables. Sylvia Blaho, Patrycja Strycharczuk, Marleen van de Vate, Minjeong Son, Violeta Martínez Paricio, and Ryan Johnson have been my friends and companions in the lonely north. Patrycja, thanks for believing in me. Marleen, thanks for being my office mate and confidante. Minjeong, we should schedule yet another (half)marathon together. Violeta, I am grateful for your kindness and support. Ryan, thanks for discussing all things phonology with me, and for proof-reading this thesis. I am also grateful to my other fellow Ph.D. students. On the P side of linguistics they are Islam Youssef, Pavel Iosad, Dragana Šurkalović, and Helene Andreassen. On the S side of linguistics they are Monika Bader, Kristine Bentzen, Pavel Caha, Éva Dékány, Xuan Di, Madeleine Halmøy, Björn Lundquist, Andrea Márkus, Rosmin Matthew, Yulia Rodina, Sandhya Sun-

daresan, Kaori Takamine, and Naoyuki Yamato. For LaTeX related assistance, I thank Sylvia Blaho, Patrik Bye, and Pavel Iosad.

I am also grateful to other CASTL phonologists. Patrik Bye is probably the most modest person I ever met. Martin Krämer has discussed vowel harmony with me many times. Ove Lorentz has told me a lot about Norwegian, Sámi, and Danish. Christian Uffmann has contributed to this thesis in the form of most useful comments. Olga Vaysman offered me wise advice when I most needed it. I have also benefitted from other CASTL linguists: Klaus Abels, Eefje Boef, Antonio Fábregas, Irene Franco, Gunnar Hrafn Hrafnbjargarson, Luisa Martí, Thomas McFadden, Tore Nessel, Gillian Ramchand, Isabelle Roy, Michal Starke, Peter Svenonius, Tarald Taraldsen, Øystein Vangsnæs, and Marit Westergaard. For administrative help at unusual hours I thank Tore Bentz, Christin Kristofferson, and Ståle Berglund. I would also like to say thanks to my Tromsø friends: Ørjan Bergan, Gry Gaard, Svenne Knutsen Duolljá, and Rachel Peterson.

Much of this thesis has been conceived during my research stay at the University of Massachusetts Amherst in Fall 2008. John McCarthy has been following my becoming a linguist since 2005. He, Joe Pater and John Kingston have given me great feedback on my ideas about feature spreading. Thanks also to: Diana Apoussidou, Rajesh Bhatt, Chris Davis, Emily Elfner, Meg Grant, Karen Jesney, Michael Key, Wendell Kimper, Kevin Mullin, Kathryn Pruitt, Elisabeth Selkirk, Brian Smith, and Martin Walkow.

I would also like to thank other phonologists that have contributed to this dissertation with their comments, questions and criticism: Paul Arsenault, Michael Becker, Nick Clements, Stuart Davis, Daniel Dinnsen, Elan Dresher, Brett Hyde, Larry Hyman, Ken de Jong, Andrew Nevins, Aaron Kaplan, Daniel Karvonen, Michael Kenstowicz, Yuni Kim, Paul Kiparsky, Alexei Kochetov, Sara Mackenzie, Shakuntala Mahanta, Michael Marlo, David Odden, Petya Racz, Keren Rice, Sharon Rose, Donca Steriade, and Matt Wolf.

The current, somewhat revised version of this thesis benefited greatly from the comments of the committee members: Laura Downing, Martin Krämer, and Marc van Oostendorp. I have also received feedback from Akinbiyi Akinlabi, Eric Baković, Will Bennett, Paul de Lacy, Gillian Gallagher, Maria Gouskova, Jane Grimshaw, Paula Houghton, and Alan Prince.

My journey into the world of phonology started back in 1998. Several people played an important role in this enterprise. I would like to thank Karmen Kenda Jež, Erika Kržišnik, Lanko Marušič, Vesna Mildner, Janez Orešnik, Tanja Tolar, Andreja Žele, Maja Žorga, and my family, particularly Tina Jurgec.

Finally, I would like to thank my son Juri [ˈjúrɪ]. He is the greatest son one could ever wish for. I dedicate this dissertation to him.

with some other feature. This suggests that the targeted structure of an alignment constraint is a powerful device that can determine the locality of targets. It is this property of alignment constraints that replaces earlier theories and mechanisms of locality in feature spreading (Howard 1972; Jensen 1974; Odden 1994). An additional property of such an alignment-based approach is that the relationship between a particular spreading feature and its targeted structure is not random, but grounded typologically and phonetically. For instance, [RTR] prefers to spread to vowels more than to consonants, and to non-high vowels more than high vowels. This can be captured by three alignment constraints with [RTR] as the spreading feature. These constraints have a root node, a vowel, or a feature common to non-high vowels as the targeted structure. Consequently, the constraints never prefer a candidate that spreads the feature [RTR] to all consonants, but not to vowels. As a matter of fact, no such patterns have been reported.

Part II provides evidence for the hierarchical structure of feature spreading. The main argument is based on the distinction between two types of targets. Chapter 4 presents evidence that not all targets can be treated the same. In particular, some targets undergo spreading, but act as blockers at the same time. These targets are termed *icy targets*. Icy targets remain unexplained in classic Autosegmental Phonology in which all association lines are equivalent. The alternative model, in which branching is maximally binary (Vergnaud 1979; Zubizarreta 1979, 1982; Halle & Vergnaud 1980, 1981; Kaye 1982; Poser 1982; Leben 1982), predicts a distinction between the two types of targets. According to this approach, spreading involves maximally binary, recursive and headed domains, as we have seen in (1). This relates directly to icy targets. Some root nodes can contain a head (and allow further spreading), while others cannot. Icy targets can be associated with a feature, but cannot be headed, which means that there can be no further targets.

Chapter 5 extends the notion of binarity and headedness to a further distinction between targets and transparent segments. Simply put, the proposal is that both targets and transparent segments are associated with a feature, but the association lines are not equivalent. This allows for a view of assimilation (i) in which a feature is more prominently realized on targets than on transparent segments and (ii) in which all assimilation is strictly local. Both properties are supported by a large body of phonetic studies. This view also has several phonological consequences. On the one hand, transparency is comparable to being a target. Both targets and transparent segments violate constraints on heads. On the other hand, alignment constraints can be satisfied only by targets, but not by transparent segments. In the broader scheme of things, transparency is a condition dependent on constraint interaction and not a fixed property of some segment with respect to a particular feature—both within a language or cross-linguistically.

Chapter 6 looks at segmental blockers. Blockers differ from transparent segments and targets in that they are never associated with a particular spreading feature. Blockers terminate spreading, even if there are other available targets within a domain. Blocking is attributed to a high ranked feature co-occurrence constraint, which is violated by any associated root node (either a target or a transparent segment). Since skipping of a root node is never possible, spreading terminates instead.

The final point regarding the distinction between association lines is the distinction between triggers and all other segments (including final targets), which is addressed in chapter 7. This chapter focuses on patterns that show different behavior for triggers than for all other segments associated with a feature. More specifically, only a subset of segments that can be associated with a feature can act as triggers. This leads to the conclusion that triggers have a different representation than targets, and this distinction can be referred to by constraints.

Part III discusses interactions of assimilation with two other phenomena. Chapter 8 looks at parasitic assimilation. Parasitic patterns involve two interacting features. In particular, spreading of one feature depends on another feature. Parasitic assimilation is enforced by agreement constraints. While these are a well-established class of constraints in OT, they get a slightly different flavor in the current approach to feature spreading. First, the new agreement constraints do not need any reference to adjacency or neighborhood, because they work in combination with alignment constraints that restrict spreading to a domain. Second, the new agreement constraints limit spreading to a subset of all targets of alignment constraints. This means that parasitic patterns skip targets which are not normally transparent. This distinction between regular and parasitic assimilation is supported by cross-linguistic generalizations in rounding and consonant harmony, which appear to be more similar than previously assumed.

Chapter 9 looks at positional effects in assimilation. Some assimilation patterns prefer that a segment in a particular position determines feature specifications of all other segments within a domain. This effect is attributed to another well-established class of constraints—positional faithfulness. A high ranked positional faithfulness constraint can protect prominent positions from some effects of alignment constraints. I complement the existing types of positional faithfulness with edgemoost faithfulness. I provide evidence that languages prefer faithfulness to segments that are rightmost within a particular domain. This prediction is supported by cross-linguistic patterns in voicing assimilation, consonant and vowel harmonies.

To summarize, this dissertation provides a unified account of assimilation as feature spreading. Assimilation is alignment-based and hierarchical. It may also involve other variables, such as agreement or positional effects. Under this view,

various assimilation patterns can be accounted for by using a single representational framework. This includes vowel, nasal, consonant harmonies, local consonant assimilation, vowel–consonant interactions, and tone spreading.

Part I

Assimilation as Alignment

Chapter 2

What is assimilation

In this thesis, I argue that all assimilation processes have essentially the same mechanism. This chapter constitutes the first step in this undertaking, providing a basic overview of different variables in assimilation. First, I examine what is common to all assimilation processes and how they can be set apart from other segmental alternations (section 2.1). I take a look at the parameters by which individual cases of assimilation may vary from one another. In particular, I argue that assimilation involves three basic variables. Second, I offer an analysis that incorporates these three variables (section 2.2). The proposal combines autosegmental representations with a single family of markedness constraints.

2.1 Basic parameters

Assimilation is a segmental alternation. This segmental alternation typically involves at least two segments. One of these segments (the target) alternates in the presence of the other segment (the trigger), but not otherwise. The target acquires a phonological property of the trigger. This phonological property can be characterized in terms of phonological features. In the simplest of cases, a single phonological feature of a trigger affects a target.

Voicing assimilation in Russian can serve as an example of assimilation (Hayes 1984a; Kiparsky 1985; Padgett 2002b, *inter alia*). Russian has two kinds of obstruents: voiced and voiceless. Both voiced and voiceless obstruents can appear before a vowel or a sonorant. The position before an obstruent, however, is restricted, as shown in (3). An obstruent preceding a voiced obstruent is always voiced. An obstruent preceding a voiceless obstruent is always voiceless. As we see in (3-a), the realization of the final obstruent in the prefix /ot-/ depends on the root-initial segment; it is voiced before a voiced obstruent, but not elsewhere. As we see in (3-b), the realization of the final obstruent in the prefix /pod-/ depends on the

subsequent root-initial segment; it is voiceless before a voiceless obstruent, but not elsewhere.

(3) Voicing assimilation in Russian (Padgett 2002b:2)

a.	ot-jehat ^j	‘to ride off’
	ot-stupit ^j	‘to step back’
	od-brosit ^j	‘to throw aside’
b.	pod-nesti	‘to bring (to)’
	pot-pisat ^j	‘to sign’
	pod-zetʃ	‘to set fire to’

Russian voicing alternations are a case of assimilation. In particular, voicing or voicelessness of a prefix-final obstruent (the target) is conditioned by voicing of the root-initial obstruent (the trigger). Voicing or voicelessness is the phonological property (feature) of the trigger that is obtained by the target obstruent. All other segments remain phonologically unaffected.

The trigger, the target, and the phonological feature connecting the two are the three ingredients of assimilation. Segmental alternations that lack one of them are not assimilation. As an example of a pattern that is not assimilatory, let us look at an alternation that happens independent of a segmental trigger. Russian Final Devoicing in (4), is an alternation in which voiced obstruents alternate at the right edge of the phonological word. In this position, they become voiceless. In (4-a), root-final voiced obstruents of the genitive singular forms become voiceless in the nominative singular forms, which contain no suffixes. The target of Final Devoicing is the final obstruent. The trigger, however, is not a segment (or a feature), but a condition on the right edge of the phonological word: no voiced obstruents are allowed in that position.

(4) Final devoicing in Russian (Padgett 2002b:2)

	GEN.SG	NOM.SG	
a.	sled-a	slet	‘track’
	raz-a	ras	‘occasion’
	plʲaʒ-a	plʲaʃ	‘beach’
b.	pojezd-a	pojest	‘train’
	vizg-a	visk	‘squeal’
	izb-a	isp	‘hut’

The data in (4-b) reveal that the obstruents immediately preceding the word-final obstruent are also voiceless. One option is to see this further devoicing as yet

another case of assimilation, in which the final obstruent acts as a trigger and targets the preceding obstruents.¹

We have now seen two segmental alternations—voicing assimilation and final devoicing. Only the former involves assimilation, since it contains a segmental trigger, a target and a phonological property shared by the trigger and the target. This phonological property, voicing or voicelessness, is construed in terms of a single phonological feature.

So far I have focused on the role of a single phonological feature in assimilation. In this thesis, I will argue that assimilation typically involves two different features: the spreading feature and the targeted feature. The spreading feature is contained within the trigger and the output of any target. The inputs of the targets normally do not contain the spreading feature, but they do contain another feature, which distinguishes them from non-targets. This second feature is the targeted feature. Recall that Russian voicing assimilation affects only obstruents, but not sonorants or vowels. This suggests that only obstruents are potential targets in this alternation. The targeted feature in this case can be characterized in terms of a natural class of obstruents to the exclusion of all other segments. The targeted feature thus distinguishes between targets and all other segments. In what follows, I will argue that not only Russian voicing assimilation but in fact any assimilation involves two different features: the spreading feature and the targeted feature.

I now proceed by reviewing more cases of assimilation. I will do this in three steps. I first discuss the spreading feature (section 2.1.1), followed by the targeted feature (section 2.1.2). Finally, I argue that assimilation is also affected by prosodic or morphological domains (section 2.1.3).

2.1.1 Spreading feature

Assimilation is a very common phenomenon, both cross-linguistically and within an individual language. In the previous section, we have seen one example of assimilation—voicing assimilation in Russian (3). In this section, I provide further examples. The four cases to be reviewed differ from one another in that each involves a different assimilating, or spreading, feature. I first discuss nasal harmony in Applecross Gaelic, followed by emphasis spread in Southern Palestinian Arabic, Finnish vowel harmony, and Diola-Fogny place assimilation. By reviewing these data, I show that assimilation processes may differ with respect to their spreading feature. Yet while these processes may vary in terms of what the spreading feature is, they do reveal a common pattern. This empirical generalization constitutes the

¹Another option is to consider this neutralization (Lombardi 1999; Kehrein & Golston 2004). Section 9.3 gives arguments why this alternative ultimately fails.

first step in determining what assimilation is and will be complemented by two other generalizations in the subsequent sections.

In (5), we see the distribution of nasality in Applegcross Gaelic (henceforth, Applegcross). Nasality of the stressed nasal vowels (underlined>) affects all following continuants, while stops cannot become nasal. Nasality also affects the onset of the stressed syllable. These patterns can be analyzed in terms of the spreading feature. Nasalization is the property of a stressed vowel which targets continuants rightwards until the process is terminated by a stop. Similarly, nasalization also targets the onset of the stressed syllable, but not if it is a stop. This pattern is similar to voicing assimilation in Russian in two respects. First, the alternation is triggered by some phonological property—a feature of the trigger. Recall that in Russian (3), this property is the value of voicing of an onset obstruent. In Applegcross, on the other hand, it is the nasality of a stressed vowel. Second, the spreading feature affects adjacent segments. In Russian, voicing affects all obstruents in the (immediately preceding) coda, but not obstruents in the onset of the preceding syllable (cf. [pod-ʒetʃ] vs. [pot-pisatʲ]). In Applegcross, nasality affects all following continuants, but no segment across a stop. In other words, both processes involve a contiguous string of segments.

(5) Nasal harmony in Applegcross Gaelic (Ternes 1973:134,135)

ˈ <u>ã</u> hũç	‘neck’
ˈ <u>š</u> çhĩ	‘tame’
f [~] r [~] ĩã·ṽ	‘root.PL.’
k ^h ɔˈṽĩã·t	‘how much/many?’
tãṽ	‘ox, stag.PL’
st [~] rãĩ·ṽ	‘to be luxurious’
ˈk ^h çĩšpaxk	‘wasp’
t ^h ãhũšk	‘fool’

Another assimilation process that also involves a contiguous string of segments is emphasis spread in Southern Palestinian Arabic (Davis 1995; Zawaydeh 1999; Watson 1999, 2002; henceforth, SPalestinian). In this process, some consonants cause all preceding segments to become pharyngealized. In (6), pharyngealized segments are capitalized, and triggers are additionally marked with a subscript dot. In the dataset below the alternation affects preceding segments. In terms of features, emphasis involves spreading of the pharyngealization feature from a triggering consonant to target segments, forming a contiguous string of segments.²

²SPalestinian also has rightward pharyngealization, which I leave out in this chapter. The pattern is further analyzed in section 6.3.

- (6) Emphasis spread in Southern Palestinian Arabic (Davis 1995:473–474)
- | | |
|------------|--------------------------|
| BALLAAṢ | ‘thief’ |
| ħAḏḏ | ‘luck’ |
| ʔABSAT | ‘simpler’ |
| BAAS | ‘bus’ |
| MAJAṢṢASif | ‘it didn’t become solid’ |
| Ṭiin-ak | ‘your mind’ |
| ʕATʃaan | ‘thirsty’ |

Many assimilations involve targets that are not adjacent to each other. For instance, vowel harmony is an alternation which affects only vowels, while consonants are typically ignored. In (7), we see some data from Finnish (Ringen 1975/1988; Kiparsky 1981; Ringen & Heinämäki 1999). Finnish suffix vowels alternate depending on the root vowels: suffix vowels are front after front root vowels, and back after back root vowels. The feature for vocalic place originates from the root and targets the suffix; it affects only vowels. Finnish vowel harmony thus differs from the previously discussed cases, because the spreading feature affects targets across unaffected segments. Finnish is further analyzed in sections 2.2.2 and 5.5.

- (7) Front/back harmony in Finnish (Ringen 1975/1988:77; Ringen & Heinämäki 1999:305)
- | | | | |
|----------|-----------------|----------|-----------------------|
| næh-kø:n | ‘see-DIRECT.SG’ | tul-kø:n | ‘come-DIRECT.SG’ |
| næk-ø | ‘sight’ | tul-o | ‘coming’ |
| pøytæ-næ | ‘table-ESSIVE’ | pouta-na | ‘fine weather-ESSIVE’ |

Assimilation processes reviewed so far involve exactly one feature: voicing in Russian, nasality in Applecross, pharyngealization in SPalestinian, and backness in Finnish. Some assimilation processes, however, involve multiple features. The Diola-Fogny data in (8) show alternations that involve consonantal place. In particular, the reduplicated forms display a restriction on nasal-obstruent clusters. The final nasal of the first root has the same place of articulation as the following obstruent. The obstruent’s place of articulation affects the preceding nasal. A labial nasal becomes dorsal when followed by a dorsal obstruent. A coronal nasal becomes labial before a labial, and a dorsal nasal becomes coronal before a coronal. In other words, the three-way consonantal place contrast in the coda is neutralized and determined by the following onset, which contains one of three consonantal place features or feature values. This pattern contrasts with Russian voicing assimilation, where we see only a two way distinction (between voiced and voiceless obstruents). The consonantal place assimilates regardless of the fact it has at least three values (labial, coronal, dorsal).

- (8) Nasal place assimilation in Diola-Fogny (Sapir 1965:16)
- | | |
|-----------------------|-----------------------|
| ku-b <u>ɔ̃</u> m-bən | ‘they sent’ |
| na-ti: <u>ŋ</u> -ti:ŋ | ‘he cut (it) through’ |
| ni-ga <u>ŋ</u> -gam | ‘I judge’ |

The reviewed cases are a small subset of all assimilation patterns, yet they capture some of the typological variability. They involve different features, which show a consistent pattern. In particular, assimilation involves at least one phonological property. Such a property can be characterized in terms of a single feature, which is contained within a single segment (a trigger) in the input, and affects one or more segments (targets) in the output. However, this characterization of assimilation is insufficient. We have already observed that some features target only specific segments. In the following section, I look at these segments, and show that they also have a specific phonological property in common. This is the targeted structure.

2.1.2 Targeted structure

So far I have looked at assimilation from the perspective of the trigger. In particular, I pointed out that assimilation processes may differ with respect to what feature is being spread. Now I turn to targets by showing some of the variation with respect to what segments can act as targets. More specifically, I show that the same spreading feature may target different classes of segments, which can be characterized in terms of another feature. This suggests that assimilation involves at least two variables: a spreading feature and a targeted structure. I will look at three spreading features: the features responsible for nasality, tongue root position, vocalic frontness.

Recall that in Applecross (5), nasality affects segments following a stressed nasal vowel. This nasal assimilation is terminated by a stop, which cannot become nasal. Such a distribution contrasts with the nasal assimilation found in Yaka (Hyman 1995). In (9-a), we see that the perfective suffix in Yaka is usually realized as [-idi]. However, when there is a nasal sonorant in the root, the suffix surfaces with a nasal sonorant as [-ini]. This also happens when the triggering nasal is not at the right edge of the root, which is shown in (9-b). So, as long as there is a nasal sonorant in the root, the suffix will also contain a nasal. As observed by Hyman (1995), nasality targets only voiced consonants, ignoring all other segments. This pattern contrasts with the one found in Applecross, where intermediate vowels are affected. In other words, only the voiced consonants are targeted in Yaka, while all continuants are targeted in Applecross. This suggests that the same feature may target to different segments. If these two cases, the targeted classes are in direct opposition. The Yaka pattern is further analyzed in section 8.5.4.

(9) Nasal harmony in Yaka (Hyman 1995:6,9)

a.	tsub-idi	‘roam’	tsum- <u>ini</u>	‘sew’
	kud-idi	‘chase’	kun- <u>ini</u>	‘plant’
	kik-idi	‘obstruct’	wun- <u>ini</u>	‘murmur’
b.	mak-ini	‘climb’	finuk-ini	‘sulk’
	nik-ini	‘grind’	miituk-ini	‘sulk’

The second example in this section concerns alternations in tongue root position. Recall that in SPalestinian emphasis spread (6), pharyngealized consonants affect the preceding segments. Most analyses (Davis 1995; McCarthy 1997) assume that the spreading feature in this case is the one responsible for tongue root retraction. In SPalestinian, this spreading feature affects all preceding segments (consonants and vowels).

A more common alternation involving tongue root is vowel harmony, which involves only vowels. In Twi (10), for example, the affix vowels depend on the root vowels (Berry 1957; Painter 1973). Tense root vowels may occur with tense affix vowels, while lax root vowels occur with lax affix vowels; consonants are unaffected.

(10) Tongue root harmony in Twi (Berry 1957:127–128,130)

biri	‘black’	o-biri	‘3P-black’
biri	‘red’	o-biri	‘3P-red’
firi	‘lend, borrow’	mi-be-firi-i	‘1P-FUT-borrow-it’
firi	‘fail, miss’	mi-be-firi-i	‘1P-FUT-miss-it’

If we compare Twi tongue root harmony and emphasis spread in SPalestinian, we see that both involve the same spreading feature. The two languages crucially differ in terms of what segments are targeted. In SPalestinian all segments are targeted, while in Twi only vowels are. The situation in Twi and SPalestinian resembles the distinction between Applecross and Yaka in that different sets of segments are targeted by the same spreading feature. The targets can be characterized as having a specific targeted structure, which is vowels in Twi and all segments in SPalestinian. Twi is analyzed in sections 3.2.2 and 9.5.2.

I now move to the final example, which involves the feature responsible for vocalic frontness or backness. Recall that in Finnish (7), the root vowel determines whether the suffix vowel will be front or back. The feature responsible for frontness/backness of root vowels affects suffix vowels. Many other languages show alternations in which a front vowel affects a consonant. For example, in Czech (11-a) a front vowel triggers an alternation that affects the secondary articulation of the immediately preceding coronal. When followed by a front vowel, coronals become palatalized. This situation resembles Finnish, where front root vowels are followed by front suffix vowels (and back root vowels are followed by back suffix

vowels), which suggests that the spreading feature in both processes is related. The crucial difference between the two alternations is in what segments are targeted. In Finnish only vowels are targeted, while in Czech only root-final coronals are targeted. The difference between the two types of targets can be characterized in terms of different targeted features. This is further supported by the Irish data in (11-b). What we see in Irish is that feature responsible for vocalic frontness targets a consonant. That is, a palatalized dorsal consonant affects the preceding nasal. The final example comes from Karaim (11-c). This language, too, exhibits palatalization of consonants, which is similar to the other three languages. What is remarkable about Karaim is that palatalized root consonants affect suffix consonants, leaving intermediate (back) vowels unaffected.

(11) Palatalization

- | | | | | |
|----|--|----------------|---|-------------------|
| a. | Czech (Rubach 2007:107) | | | |
| | plot | ‘fence-NOM.SG’ | plot ^j -ε | ‘-LOC.SG’ |
| | vod-a | ‘water-NOM.SG’ | vod ^j -ε | ‘-LOC.SG’ |
| b. | Irish (Ní Chiosáin 1994:97) | | | |
| | ahn ^j in | ‘recognizes’ | ahn ^j i:ŋ ^j -k ^j i:ro:g | ‘a beetle recog.’ |
| | gan | ‘without’ | giŋ ^j -x ^j i:l | ‘without sense’ |
| c. | Karaim (Kowalski 1929; Nevins & Vaux 2004:178–179) | | | |
| | suv-dan | ‘water-ABL’ | k ^h un ^j -d ^j an ^j | ‘day-ABL’ |
| | boł-uf-uv-tfu | ‘helper’ | t ^h uz ^j -v ^j -t ^j u-d ^j an ^j | ‘from the author’ |

On the basis of the data in (11) we can conclude that the same phonological feature is responsible for vocalic frontness and secondary palatalization. Nevertheless, individual languages can vary in terms of what segments are targeted. Vowels are targeted in Finnish, whereas they are not targeted in the other three languages. Instead, coronals are targeted in Czech, nasals are additionally targeted Irish, and all consonants are targeted in Karaim.

The three examples in (11) strongly suggest that the targeted structure in any assimilation process is not predictable from the spreading feature. Thus, an analysis of an assimilation process must include at least two variables. These two variables are independent, as the relationship between them is not entirely predictable. A particular spreading feature may occur in combination with several targeted features. For example, the feature responsible for tongue root position targets vowels in Twi, but all segments in SPalestinian.

We have now seen that assimilation can differ in two basic variables. The first is the spreading feature, while the second is the targeted feature. In the subsequent chapters, I will show two things. First, the second variable is not necessarily a feature, but can also be a root node or a morphological/prosodic domain. I will thus refer to it as the targeted *structure* (rather than feature). Second, while the

spreading feature does not automatically determine the targeted structure, the relationship between the two is also not entirely random. A particular spreading feature comes with a subset of all available targeted structures.

In the following section, I show that there is another variable in which assimilation processes may differ from one another—the domain. Some assimilation patterns may be sensitive to the right edge, while the other are sensitive to the left edge, of a particular phonological domain. Furthermore, some assimilation patterns are limited to a narrow phonological domain such as the syllable, while others are limited to a larger domain such as the prosodic word or phonological phrase.

2.1.3 Domain

Prosodic and morphological domains are known to affect many phonological patterns (McCarthy & Prince 1993b). So, it is unsurprising that domains also influence assimilation. Here, I discuss two ways in which assimilation is affected by phonological domains. First, I show that assimilation may differ in terms of directionality. Assimilation may apply leftwards or rightwards. Second, I demonstrate that assimilation may be restricted within a particular domain, and that individual assimilation patterns may have specific domains.

In previous sections, we have already seen how assimilation processes may differ with respect to directionality. Recall that nasalization in Applecross (5) applies in both directions and targets continuants. This contrasts with other languages with nasal harmony. Below I discuss two cases of nasal harmony which differ in terms of directionality. In the first one, nasalization affects segments to the right of the trigger, while in the second one nasalization affects segments to the left of the trigger.

In (12), we see the distribution of nasality in Sundanese (Robins 1957; Langendoen 1968; van der Hulst & Smith 1982; Cohn 1990, 1993a; Piggott 1992; Piggott & van der Hulst 1997; Benua 1997; Walker & Pullum 1999; Walker 1998/2000). Any vowel following a nasal sonorant is nasalized. Consonants cannot become nasal. Nasalization is triggered by a nasal sonorant {m, n, ɲ, ŋ} and applies rightwards until it encounters a consonant. Consonants never become nasal, and terminate further assimilation.

(12)	Nasal harmony in Sundanese (Robins 1957:91,95)	
	māro	‘to halve’
	nīār	‘to seek’
	ŋūliat	‘to stretch (INTR.)’
	kumāhā	‘how’
	ŋājak	‘to sift’
	māwur	‘to spread’
	mōlohok	‘to stare’

In contrast, Capanahua in (13), displays leftward nasalization (Loos 1969; Halle & Vergnaud 1981; van der Hulst & Smith 1982; Safir 1982; Piggott 1987; Piggott & van der Hulst 1997; Piggott 2003; Walker 1998/2000). This assimilation process is triggered by a nasal sonorant stop and applies leftwards, targeting vowels and glides. Other segments terminate further assimilation. For example, in the form [bīmi] ‘fruit’ nasalization is triggered by the nasal sonorant [m] and targets the first vowel, but not the last one.

(13)	Nasal harmony in Capanahua (Loos 1969:177,178)	
	pōjān	‘arm’
	bōōn	‘hair’
	bīmi	‘fruit’
	wurānwuu	‘push it’
	bāwīn	‘catfish’

By comparing Sundanese and Capanahua we see that assimilation may differ with respect to directionality. Some assimilation processes apply rightwards (Sundanese), while others apply leftwards (Capanahua). The third type of assimilation is bidirectional, applying in both directions. Nasalization in Applecross (5) is of this type.

One way to look at this cross-linguistic variation is to say that directionality is a separate parameter. For example, rightward (rather than leftward) assimilation in Sundanese could be attributed to a rule or a constraint that contains such a directional variable. This conclusion, however, is slightly misleading, as becomes evident if we compare the following three types of grammars. Grammar \mathcal{A} contains both directionality and domains as assimilation variables. Grammar \mathcal{B} contains only domains (but no directionality), while grammar \mathcal{C} contains only directionality (but no domains). In the light of the reviewed data, grammar \mathcal{C} is not feasible. This is because many assimilation patterns terminate at the boundary of some morphological or prosodic domain. For example, Finnish vowel harmony (7) is restricted to prosodic words. This leaves us with grammars \mathcal{A} and \mathcal{B} . In an overwhelming majority of cases the two grammars do not make different pre-

dictions. If so, parsimony prefers grammar \mathcal{B} (that contains only domains) over grammar \mathcal{A} (that contains directionality in addition to domains). Furthermore, if directionality were an *independent* variable in assimilation, we would predict at least one case of assimilation through any domain boundary (total assimilation). For example, a nasal sonorant would trigger nasalization of all subsequent segments (i.e., even across intonational phrase and sentence boundaries). We know of no language with total assimilation. Grammar \mathcal{A} can generate total assimilation since it can specify directionality without reference to a domain. Grammar \mathcal{B} , on the other hand, can only specify directionality via a domain edge, and total assimilation is not restricted within any domain. Hence, grammar \mathcal{A} has to be rejected over grammar \mathcal{B} . This leads to the conclusion that directionality is only epiphenomenal; assimilation is sensitive only to specific prosodic/morphological boundaries (Nespor & Vogel 1986; Zec 1988/1994; Peperkamp 1997). I will now illustrate this point with three examples.

Similar to Applecross (5), Epena Pedee (henceforth, Epena) nasal harmony applies bidirectionally (Harms 1985, 1994; Walker 1998/2000). Triggers are underlying nasal vowels, which are underlined in (14). Nasalization applies rightwards and leftwards, targeting all sonorants, while obstruents terminate any further assimilation. However, in leftward nasalization only the onset of the syllable containing the trigger is targeted. For example, ‘to play’ is realized as [hem \tilde{e} n \tilde{e}] and not as *[\tilde{h} em \tilde{e} n \tilde{e}]. Nasality does not affect segments across the left boundary of the syllable containing the trigger. On the other hand, rightward nasalization is not bounded by a syllable boundary. For instance, [pe \tilde{r} o \tilde{r} ã] ‘guagua’ shows nasalization across several syllables, i.e., until the word boundary is reached. In (14-b), nasalization applies rightwards even across word boundaries, as long as the two words are within a phonological phrase (Harms 1985:17).

(14) Nasal harmony in Epena Pedee (Harms 1985:16; Harms 1994:4–6)

a. Within words

pe \tilde{r} o \tilde{r} ã	‘guagua (animal)’
m \tilde{e} ⁿ dewe	‘blind snake’
wã \tilde{h} ^m da	‘they want’
k \tilde{h} ⁿ siə	‘think’
wã \tilde{a} ^m t ^h ee	‘go.FUT’
nã \tilde{w} ^e	‘mother’
m \tilde{m} ^m õ \tilde{p} nãã	‘work a lot’
hem \tilde{e} n \tilde{e}	‘to play’

b. Across words

m \tilde{u} wãã \tilde{a} nã	‘my child’	waara	‘son’
m \tilde{u} \tilde{h} ⁿ da	‘I also’	hida	‘also’

The difference between leftward assimilation up to the syllable boundary and rightward assimilation up to a phonological phrase boundary in Epena cannot be captured by a model that distinguishes directionality alone. What the Epena data demonstrate is that it is actually the domain boundaries that matter. In particular, nasality affects segments to the left boundary of the syllable containing the trigger. On the other hand, nasality also affects segments rightwards to the right boundary of a phonological phrase. Thus, assimilation targets an edge of some prosodic domain, and the apparent directionality is only the consequence of that. In other words, bidirectional assimilation can be analyzed as two separate processes, each of which can have its own domain.

Next, let us look at Somali vowel harmony (Andrzejewski 1955; Saeed 1993, 1999; Krämer 2003). Somali is known for having alternations in vowel quality that apply across several words. In (15-a) we see that a word with tense vowels affects all preceding words. That is, a word with tense vowels such as [dibi] ‘bull.GEN’ is preceded by words with only tense vowels. In contrast, ‘It is a horse’s hide’ contains only lax vowels. Somali vowel harmony can be seen as assimilating lax vowels to tense vowels. The reason for such a conclusion becomes apparent in (15-b). A word with tense vowels generally does not affect the following words. More specifically, a word with tense vowels can be followed by a word with lax vowels, but not vice versa. The alternation applies only leftward. The example ‘buy’ has a tense vowel, and all preceding vowels are also tense. This contrasts with ‘cook’ which only has lax vowels, suggesting that the demonstrative is also lax itself. However, the initial word ‘meat’ always contains tense vowels, but has no effect on the vowels to the right. An additional wrinkle in the data is a closed class of morphemes, which can be considered under the cover term clitics, as in (15-c). The focus marker /ba:/ is one of them. As we can see, the focus marker gets a tense vowel when immediately followed by a triggering word containing a tense vowel.

(15) Somali vowel harmony (Andrzejewski 1955:569,570)

a. Leftward assimilation within an Intonational Phrase

w <u>a</u> :	s <u>a</u> :n	faras	w <u>æ</u> :	s <u>æ</u> :n	dibi
DM	hide	horse.GEN	DM	hide	bull.GEN
‘It is a horse’s hide.’			‘It is a bull’s hide.’		

b. Leftward, not rightward, assimilation

hilib	k <u>a</u> :	k <u>a</u> rɪ	hilib	k <u>æ</u> :	i:bsə
meat	DEM	cook	meat	DEM	buy
‘Cook that meat.’			‘Buy that meat.’		

c. Rightward assimilation to the following clitic

<u>mɑ</u>	ʃabɛ:l	bɑ:	<u>mæ</u>	libæ:h	bæ:
QM	leopard	FOC	QM	lion	FOC
	‘Is it a LEOPARD?’			‘Is it a LION?’	

The importance of Somali data is twofold. First, Somali exhibits vowel harmony that affects a domain much larger than the word. Andrzejewski (1955) reports up to ten-word sequences with exclusively lax or tense vowels. This pattern appears to be quite close to total assimilation discussed above. Because Somali vowel harmony has a clear directional pattern, total assimilation poses a challenge to the claim that directionality is merely epiphenomenal. Instead, Somali appears to have directionality as independent variable that can apply across any domain boundary. However, such a conclusion turns out not to be true. In particular, Somali vowel harmony never traverses pauses. At the same time, faster pronunciation results in less pauses, and harmony affects more words that in slow speech. Yet these pauses appear in predictable positions. A pause can never shift from one place to another. What happens instead is that some pauses may be omitted in faster speech. This suggests that pauses are not random, but indicative of a prosodic domain, which makes Somali directly parallel to similar characteristics found in other languages. Nespor & Vogel (1986), Lahiri & Evers (1991) offer additional evidence that these restricted positions of pauses relate to a prosodic domain, such as the Intonational Phrase (IP). IPs are known to have effects on assimilation and other alternations (Selkirk 1980a; Lahiri & Evers 1991). The fact that vowel harmony does not apply across pauses is not surprising, since they are indicative of IP boundaries. This is directly relevant to Somali, in which a feature common to tense vowels targets all preceding vowels within an IP. Directionality is thus only epiphenomenal.

Second, Somali exhibits disparities in leftward and rightward spreading. As we have just seen, leftward assimilation applies within an IP, whereas rightward assimilation affects only the following clitic. Clitics are known to form prosodic domains with adjacent words. One name for such domains are phonological phrases. Under this view, Somali disparity in directionality is similar to that of Epena. Tensing leftwards applies within the IP, whereas tensing rightwards applies within the phonological phrase. In short, the Somali data strongly suggest that bidirectional assimilation consists of two separate unidirectional assimilations, each with its own domain of application. I will return to this issue in section 4.5.2.

The final example is nasal place assimilation in Catalan (Wheeler 1979, 2005). In less formal speech, place of articulation of a non-continuant affects the preceding nasal both morpheme internally, across morphemes and across word boundaries, as in (16). Assimilation applies leftwards and targets only coronal nasals. This pattern seemingly contrasts with Epena and Somali, because the domain of assimilation is not immediately apparent. However, if our reasoning is correct, the

relevant domain is larger than a prosodic word, for example a phonological (or intonational) phrase. The reason why segments preceding the word-final coronal nasal are not affected is because vowels terminate assimilation. Thus the closest the place of articulation can get to the left edge of a phonological phrase is one segment to the left (codas containing two nasal sonorants are illicit in Catalan).

(16) Nasal place assimilation across word boundaries in Catalan (Wheeler 2005: 184)

só[m m]olts	‘they are many’
só[m p]ocs	‘they are few’
só[ŋ g]rossos	‘they are large’

I have discussed three cases of assimilation across word boundaries. In Epena, nasal harmony applies across the right edge of a prosodic word, in Somali vowel harmony applies across the left edge of a phonological phrase, while in Catalan place assimilation applies across the left edge of a prosodic word. These assimilation processes target an edge of a prosodic domain larger than the prosodic word. Epena nasal harmony targets the right edge of a phonological phrase, Somali vowel harmony targets the left edge of an intonational phrase, while Catalan place assimilation targets the left edge of a phonological phrase. Assimilation in Epena and Catalan does not need to reach the edge, since this process interacts with other variables, such as blocking segments. (Blocking is further discussed in chapter 6.) I now move to the analysis of assimilation based on the three variables reviewed in this section: spreading features, targeted structures, and domains.

2.2 Basic analysis

So far we have seen three basic parameters which distinguish various assimilation processes from one another: spreading features, targeted structures, and domains. In this section, I provide a unified account which incorporates elements of Autosegmental Phonology with Optimality Theory. This analysis draws from previous approaches to assimilation. However, the current proposal is a significant modification of the previous proposals. In particular, the three empirically examined variables will be captured within a single class of markedness constraints that drive assimilation. The formal and typological properties of these markedness constraints will be shown to be superior to previous accounts.

This section consists of two parts. In section 2.2.1, I discuss the representations of features, which I am assuming in this thesis. In section 2.2.2, I introduce constraints that refer to these representations.

2.2.1 Representations

In this thesis, I approach assimilation by combining elements of Autosegmental Phonology with Optimality Theory. In this section, I look at two issues regarding phonological representations. I first discuss the nature of features themselves. In particular, I make assumptions regarding what kind of features are possible in human languages. Then, I move on to the organization of features. This includes the relationship between features within a segment and across segments.

Features

In this thesis, I use phonological features that are (i) phonetically motivated, (ii) universal and (iii) privative. Phonetic motivation means that the relationship between a phonological feature and its phonetic properties is easily predictable. Most commonly, a phonological feature will refer to some articulatory property of a particular sound. For example, [round] refers to lip rounding (and consequently lowered F2). This is a rather standard and well-established assumption (Trubetzkoy 1939; Jakobson et al. 1951; Chomsky & Halle 1968). The alternative requires a more complex phonology–phonetics interface (e.g. Hale & Reiss 2000, 2003; Hale et al. 2007; Hale & Reiss 2008; Morén 2003, 2006b, 2007b; Blaho 2008) and may also be entirely consistent with the current approach. However, devoting a significant part of this thesis to developing this interface would sidetrack the main purpose of this thesis, which is an analysis of assimilation. It is for this reason alone that I stick to a more conservative concept of phonetically motivated phonological features.

The second assumption is that features are universal. A narrowly construed definition of universal features is to say that a particular sound has identical features in all languages (Jakobson et al. 1951; Chomsky & Halle 1968). For example, an [i] in all human languages has an identical set of features—including [front], [high] and [sonorant]. A more broadly construed notion of universal features, on the other hand, takes into account some of the language-specific facts (Trubetzkoy 1939; Morén 2003, 2006b; Blaho 2008). More specifically, whether some segment has a particular feature depends both on cross-linguistic phonological/phonetic properties of analogous sounds *and* on its similarity to other sounds within the same language. What this entails can be best demonstrated with an example. In general, an [i] will always be [high], independent of what other segments within a language are. However, in a language in which the vowel with the lowest median F1 is transcribed as [e], this segment, too, may be characterized as [high] if there is sufficient phonological evidence. Sufficient phonological evidence can be found in patterns that are indicative of natural classes. When [e] exhibits different behavior in alternations than all other segments and when this difference cannot be con-

strued in terms of some other feature (e.g. [atr], [front], [closed]) or combination thereof, then there is no other option but to conclude that [e] is [high]. At the same time, [e] can never be [round] or [stop], in any language. This is because features are both universal and phonetically grounded. That is, only if a segment is pronounced with lip rounding across contexts, it can be [round]. In the same way, only if a segment is pronounced as a sequence of closure and release, can it be [stop].

It is this broader notion of universal features that I take on in what follows. There are good reasons behind such a decision. First, phonologists most of the time rely exclusively on impressionistic transcriptions rather than ones backed by articulatory and acoustic studies. Consequently, full phonetic details are rarely available. Second, there is inherent variation among individual tokens of the same segment. For example, formant frequencies of vowels are subject to coarticulatory effects of neighboring segments (e.g. Lindblom 1963) and vary according to prosodic context (Tuller et al. 1982; Engstrand 1988; Fourakis 1991; Sluijter & van Heuven 1996; Pitermann 2000), speech rate (Gay 1978; Engstrand 1988; Van Son & Pols 1992; Moon & Lindblom 1994; Erickson 2002) and across speakers (Murry & Singh 1980; Childers & Wu 1991; Wu & Childers 1991; Simpson 2001). Only a small subset of this variation informs a phonological analysis.

Finally, I will use only privative features, although the analysis is consistent with binary features. The debate as to whether features are privative, binary or both has received a good deal of attention in the literature (see Steriade 1995 for a review). While this issue is largely irrelevant given the representational assumptions in this thesis, I briefly illustrate the most important points. The argument for privative features lies primarily in the observation that feature spreading is usually asymmetrical. In the case of nasality, two binary features are posited: [+nasal] and [-nasal]. However, assimilation to [-nasal] is unattested. In this sense, segments specified as [-nasal] are indistinguishable from segments not specified for nasal. Privative features make no reference to the absence of nasality and assume only one feature, [nasal], which thus the only feature that can play any role in assimilation.

Features other than [nasal] sometimes seemingly require reference to the negative value of the feature. Here I shortly discuss two such features, [voice] and [ATR]. A good argument for [-voice] comes from Wetzels & Mascaró (2001). They argue that distributions of voicing in some languages require reference to [-voice]. For example, in Yorkshire English and Parisian French, voiceless obstruents can be followed by voiced ones, but not the reverse. Seemingly, onset [-voice] can target obstruents in the preceding coda, but [+voice] cannot. Blaho (2008) shows that these cases can be reanalyzed using privative [voice] only. She does that by using a high ranked positional faithfulness constraint (Beckman 1997; Lombardi 1999) to

preserve onset voicing/voicelessness ranked over a general faithfulness constraint against spreading and a markedness constraint *[voice]. This gets the pattern in which [voice] generally does not trigger assimilation. Hence, no reference to [–voice] is required. For similar arguments in the pre-OT context, see Lombardi (1995a,b).

Another potentially non-privative feature is [ATR]. We know many languages in which [–ATR] seems to be the spreading feature. This means that a rule or constraint must refer to [–ATR] rather than [+ATR]. However, there seem to be independent evidence that a single feature to designate tongue root position is inadequate, but needs to be replaced by two features: [ATR] and [RTR] (Archangeli & Pulleyblank 1994). If so, then [–ATR] can be replaced by [+RTR], or simply as [RTR] in terms of privative features. Thus, no reference to the negative value of the feature is required. Hence, the evidence for the negative value of a feature (rather than its absence) is not compelling.

A full list of features used in this thesis is in (17). The list contains a subset of all universally possible features. All are privative. Most of these features are often used in phonological literature. This includes major class features, vocalic features and consonant place features. These features have fairly direct phonetic correlates. For example, [atr] and [rtr] can be defined in terms of tongue root position. Although the features are universal, not every language offers evidence for every single one. For example, it is unlikely that a single language requires all vocalic height features—[high], [closed], [open], and [low]. (Here, the feature [closed] is a privative version of [–low], while [open] is a privative version of [–high].³ Yet, while some language might require the features [closed] and [low], others might show overt effects of [high] and [open]. Since features are universal, evidence from all languages needs to be considered. Consequently, an [a] might be [low] in a language even without any language-specific evidence for such a feature. In other words, the present feature theory is not maximally economic. Redundant features are a consequence of the assumption that features are universal.

- (17) Features used in this thesis (complete list)
- | | | |
|--------------|----------|---------------|
| [vowel] | [high] | [labial] |
| [consonant] | [low] | [coronal] |
| [sonorant] | [closed] | |
| [obstruent] | [open] | [retroflex] |
| | [atr] | [posterior] |
| [continuant] | [rtr] | |
| [stop] | [front] | [High (tone)] |
| [voice] | [back] | [long] |
| [nasal] | [round] | |

³Individual features will be discussed in greater detail when used in actual analyses.

In short, I will use a limited set of fairly standard, uncontroversial, phonetically motivated, universal, and privative features.

Relationships among features

The second issue concerns the organization of features, both within a segment and across segments. In Autosegmental Phonology (Goldsmith 1976, 1990; Clements 1976/1980, 1985a; Kiparsky 1981), features are represented as autosegments that may be associated with nodes. The representations are nonlinear. The highest mother-node is a root node, which establishes linearity across segments. In (18), we see two features, [F] and [G], associated with a single root node (\times). An association line represents a relationship between a feature and a root node; a segment consists of a root node and the features associated with that root node. In other words, a feature is realized on the associated root node. In the representation below, both features and the root node are synchronous with one another. Furthermore, each of the three elements (the root node and the two features) is linear to other like elements, whereas the two features are not linear to one another. I will follow this rather standard representation in this thesis.

(18) Autosegmental representations

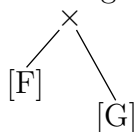

Segmental alternations may also be represented in terms of autosegments. We have seen that assimilation involves a trigger and a target. The triggering segment \times_1 is associated with the spreading feature. The targeted segment \times_2 acquires this feature in the output. In Autosegmental Phonology, assimilation is associating (or linking) a spreading feature with a target root node. This process is also termed *feature spreading*: a feature *spreads* from a trigger to a target. In (19), we see a feature spreading rule. Feature [F] is associated with the first root node in the input, but spreads to the second root node in the output. In short, the fact that a feature is pronounced on multiple segments is represented by multiple association lines between that feature and the respective root nodes. This situation typically arises in assimilation.

(19) Assimilation as feature spreading

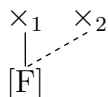

Subsequent work on autosegmental representations has claimed that features are organized in a particular fashion (Goldsmith 1976; Halle & Vergnaud 1980; Archan-

geli 1985; Clements 1985a,b, 1991; Clements & Hume 1995; Kaye et al. 1985; Steiade 1987a, 1995; McCarthy 1988; Padgett 1991/1995; Odden 1991, 1994; Halle 1995; Sagey 1990; Harris & Lindsey 1995; Halle et al. 2000; Morén 1999/2001, 2003, 2006b, 2007b; Blaho 2008, among many others). Notably, some features are directly associated with the root node, while others are not. More specifically, the dependent features are grouped together and associated with a common feature node, which is in turn associated with the root node. This approach makes use of feature geometry. In (20), we see a simplified and abstracted example. The root node is directly associated with two dependent nodes. Both of these nodes are further associated with three dependent features, of which H is a node with two dependent features. Each of these nodes or features is in a linear relationship with the same kind of nodes or features of the neighboring segments. Crucially, the relationship between some elements of representation is direct and expressed by the connecting association lines, whereas other times no direct relationship exists.

(20) Feature geometry

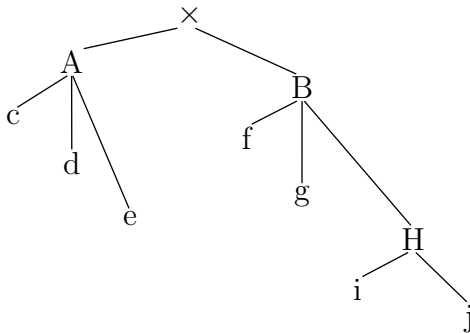

Feature geometry allows for several things. First, nodes can be exploited as a way to restrict dependent features. Consider (20) and node A which has three dependent features. Now, consider that A in a set of languages can have maximally one dependent feature. Feature geometrical representation in which A is associated with the root node, but {c, d, e} can be associated only with A is a formalization of this situation. To make the example more concrete, think of A as a node to which consonant place features attach. In many languages, only one such feature is allowed per segment. The restriction on place features thus does not appear random, but mirrors a representational fact.

Second, nodes are a tool to limit possible processes. Assume that H can only attach to some segments but not others. This has a direct implication to assimilation. The features dependent of H—i and j—can spread to segments that allow H, but skip segments that do not. Now, think of H as a vowel place node. In many languages, vowel place features can spread over consonants (as in Finnish), but typically not from consonants over vowels. This means that vowels contain the vowel place node, while consonants generally do not. Hence, vowel place fea-

tures may look for adjacent vowels, which contain an appropriate node with which they can be associated. Consonants do not contain the appropriate node and are ignored (Clements 1985b; Sagey 1990; Odden 1991, 1994; Morén 1999/2001, 2003, 2006b, 2007b). This is consistent with the cross-linguistic data: no language shows spreading of (primary) consonant place across vowels (Shaw 1991; Gafos 1996/1999; Hansson 2001; Rose & Walker 2004).

In this thesis, I assume a less restrictive model, in which features are not organized in any particular fashion; what matters is whether a feature is associated with a particular root node or not. This means that restrictions on feature spreading will never depend on organization of features within a segment. Instead, feature spreading or lack thereof will rely on other mechanisms. For example, the fact that vocalic place can spread over consonants, but not the reverse, will follow from specific constraints and their rankings.

My choice to leave aside the organization of features with respect to one another follows from a particular model of feature spreading that I am advancing. In this model, no constraint makes reference to segment-internal organization among features. In other words, while features may be organized in a particular fashion, the model proposed in this thesis does not make any reference to such organization.

To summarize, I will make use of only fundamental representations of Autosegmental Phonology. A rule or a constraint may refer to a specific privative feature, a root node, an association line or a combination thereof, but cannot refer to the negative value of a feature or a dependency relationship between segment-internal nodes, features, and interconnecting association lines.

2.2.2 Constraints

Autosegmental representations are referred to by OT constraints. These come in two varieties: faithfulness and markedness constraints. Feature spreading entails a disparity between an input and an output. This suggests that feature spreading is enforced by markedness constraints. In other words, a candidate that contains a multiply associated feature fares better on some markedness constraint compared to a candidate with a singly linked feature. Faithfulness constraints, on the other hand, inhibit spreading. Adding an association line between a feature and a root node incurs a violation mark of some faithfulness constraint. In this section, I argue that the *basic* feature spreading pattern can be accounted for using a single family of markedness constraints which outrank the relevant faithfulness constraints. In the following chapters, I will further show that the various *restrictions* on assimilation give evidence for four further constraint families.

I first introduce the template for these particular markedness constraints. Their effect is demonstrated briefly using two examples: Applecross nasal harmony and Finnish vowel harmony. The basic patterns in the two languages require one

markedness constraint, which outranks a faithfulness constraint. The markedness constraints in the two languages are minimally, yet significantly, different.

Alignment

Feature spreading is enforced by markedness constraints. Different markedness constraints have been proposed in the literature. One established approach is to extend Generalized Alignment (McCarthy & Prince 1993a) to segmental features (Kirchner 1993; Smolensky 1993; Cole & Kisseberth 1995b; Itô & Mester 1995a; Akinlabi 1996; Pulleyblank 1996; Golston 1996; McCarthy 1997; Ringen & Vago 1998; Archangeli & Pulleyblank 2002, among many others). The logic behind such analyses is simple: an alignment constraint prefers an output in which a feature is aligned with an edge of a phonological domain such as a syllable, prosodic word, or phonological phrase.

As an example, let us consider the constraint $\text{ALIGN}([\text{nasal}], \text{R}; \text{PWD}, \text{R})$ in (21). This constraint penalizes outputs containing oral segments after a nasal segment within a Prosodic Word.

- (21) $\text{ALIGN}([\text{nasal}], \text{R}; \text{Prosodic Word}, \text{R})$
 For every [nasal] autosegment there must be a Prosodic Word, such that the rightmost segment associated with [nasal] is also the rightmost segment of a Prosodic Word.

The constraint in (21) contains four variables: a single feature, a domain, and two specified edges. However, the data reviewed suggest that feature spreading actually involves two features. In addition to a spreading feature one needs targeted features/structures. This empirical fact is not consistent with the one feature plus one domain constraint template as in (21). One solution would be to propose other constraints. For example, feature co-occurrence constraints could exempt a class of segments from being targeted. The problem with this solution is that it can exempt any segment, which predicts many unattested patterns. That is, not every feature spreads to all possible combinations of targets. I will address this issue in chapters 3, 5, and 6. An alternative would be to propose a revision of alignment constraints, and this is the option I take. The revised version should include at least three variables: one spreading feature, one targeted structure, and one domain. It turns out that such a template has been proposed for prosody by Hyde (2008).

Hyde (2008) proposes markedness constraints that have most characteristics of classical alignment constraints. In particular, the constraints prefer outputs in which two categories (features, domains) are aligned with one another. However, while classical alignment constraints assign violation marks to categories and their edges, Hyde's constraints assign violation marks to sets of violating pairs or triplets

of categories. This means that for a given input the number of violation marks will be dependent on both the aligned categories and the offending categories. More specifically, while the alignment constraint $\text{ALIGN}([\text{nasal}], R; \text{Prosodic Word}, R)$ in (21) can be violated maximally once per instance of $[\text{nasal}]$, Hyde's constraints effectively incur violation marks for each oral segment after $[\text{nasal}]$, as long as this segment is within a Prosodic Word. I will now look at Hyde's proposal in more detail.

One type of Hyde's alignment schema is presented in (22). This constraint assigns a violation mark for every triplet $\langle \text{Cat1}, \text{Cat2}, \text{Cat3} \rangle$, if and only if Cat2 precedes Cat3 within Cat1 .⁴

(22) Right edge distance sensitive alignment schema (Hyde 2008)

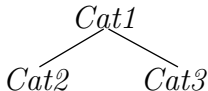
- a. $*\langle \text{Cat1}, \text{Cat2}, \text{Cat3} \rangle$ / 
- b. Assign a violation mark for every triplet $\langle \text{Cat1}, \text{Cat2}, \text{Cat3} \rangle$, iff
 Cat1 is associated with Cat2 and Cat3
 and
 Cat2 precedes Cat3 .

The constraint in (22) consists of two parts. The first one is the violating triplet $\langle \text{Cat1}, \text{Cat2}, \text{Cat3} \rangle$, while the second one is the arrangement of these categories. Both parts have an effect on evaluation. The second part includes three relations. The relationship between Cat1 and the two other categories is that of association. This means that the constraint incurs a violation mark only when both Cat2 and Cat3 are associated with the same Cat1 . However, such a situation does not necessarily entail a violation mark. This is where the relationship between Cat2 and Cat3 comes into play. The constraint in (22) is violated only if Cat2 precedes Cat3 , but not the reverse. The relationship between the latter two categories can thus be characterized in terms of precedence, which is a widely accepted temporal relation in phonology. In Autosegmental Phonology, for example, any two instances of the same feature or any two root nodes are in a precedence relation. In OT, faithfulness constraints that maintain precedence have been proposed (such as LINEARITY , McCarthy & Prince 1995). Precedence is the only temporal relation evaluated by the constraint in (22), which means that directionality which is an integral part of classical alignment constraints is only indirect.

Recall that the original alignment constraints require a feature to be aligned with the edge of a prosodic domain. Hyde's modification is two-fold. First, each constraint involves at least three categories. Second, no reference is made to

⁴Hyde proposes several different alignment schemata, and most of them can be used for feature spreading. One of these other constraints is extended to segmental features in section 5.4.

edges. Instead, what matters is the relationship among the three categories. The categories may be prosodic domains, such as syllables, feet and prosodic words. This is what Hyde proposes. Another option is that the categories are features.

As argued in section 2.1, assimilation patterns can be characterized in terms of three parameters: a spreading feature, a targeted structure, and a domain. These three categories are entirely consistent with Hyde's alignment schema, which also contains three variables: the first variable is associated with the other two, which are in turn in a precedence relation. If the latter two categories are a spreading feature and a targeted structure while the first category is a prosodic/morphological domain, this seems quite similar to the markedness constraint that we are looking for. This markedness constraint will enforce feature spreading.

In (23) we see an implementation of Hyde's template that captures feature spreading. The feature alignment constraint assigns a violation mark for every triplet $\langle \textit{Domain}, [F], [G] \rangle$ if and only if (i) the *Domain* is associated with $[F]$ and $[G]$, and (ii) $[F]$ precedes $[G]$.

$$(23) \quad \text{Feature alignment} \\ * \langle \textit{Domain}, [F], [G] \rangle \quad / \quad \begin{array}{c} \textit{Domain} \\ / \quad \backslash \\ [F] \quad [G] \end{array}$$

Such a description, however, warrants further clarification. In particular, there is an important difference between a precedence relation between two root nodes and a precedence relation between two different features. In Autosegmental Phonology, precedence is established between like categories (Goldsmith 1976). For any two root nodes, there is a unique precedence relation: one always precedes the other. Similarly, for any two instances of the same feature, one always precedes the other.

Hyde uses alignment to refer to prosodic constituents such as moras, syllables, and feet. As long as these constituents are of the same type and non-overlapping, precedence among these constituents is equivalent to linear precedence between root nodes. To put it in the language of Autosegmental Phonology: all feet count as the same level of representation, and the same is true for all syllables and moras. The challenging part comes once we consider that different prosodic constituents can interact with one another. In particular, if the dependent domains are of different types (e.g. a syllable and a mora), precedence is harder to establish. This is directly relevant to features. In the template (23), the dependent categories are two different features. Two different features are not strictly ordered with respect to one another. Instead, they are most times overlapping; a segment can be associated with multiple features at the same time. This strongly suggests that precedence across features must be defined in a crucially different way.

The difference between root node precedence and featural precedence becomes apparent when we look at the representations such as the one in (24), in which we

see a feature [F] associated with all root nodes, a feature [G] associated with \times_2 and a feature [H] associated with \times_3 . Precedence relations among root nodes are unambiguous: \times_1 precedes \times_2 which precedes \times_3 . On the other hand, precedence among the three features is harder to establish. First, it seems likely that [G] precedes [H] rather than the other way around. This is because the root node associated with [G] precedes the root node associated with [H]. We can see that this precedence relation between the two features has been established indirectly, via the root node tier and requires no reference to any feature tier. As regards precedence between [F] and the other two features, the answer is unclear. On the one hand, one could say that [F] precedes both [G] and [H] because \times_1 is associated with [F] and but not [G] and [H]. The alternative would be to say that [F] overlaps with the other two features and thus [F] does not precede [G] and [H] (or vice versa). In what follows, I will argue that it is this second option that is correct.

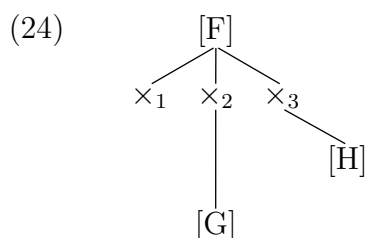

It is now evident that precedence relations are obscured because features may overlap with one another. Hence, precedence relations among features are established in a different way than precedence relations among root nodes where overlapping is not possible. Thus, we need two different notions of precedence. Precedence in a traditional sense is a relation among root nodes (or several instances of the same feature). Featural precedence (or f-precedence for short) is a relation among different features, and this relation is established indirectly via root nodes. A feature [G] precedes a feature [H] if all root nodes associated with [G] precede [H]—as in (24). The additional wrinkle concerning f-precedence comes from the notion of association. In Autosegmental Phonology, association implies temporal alignment between a feature and a root node. When a feature [F] is associated with a root node \times , precedence cannot be established. That is to say, neither [F] precedes \times nor \times precedes [F]. This can be extended to f-precedence. If two features [F] and [G] are associated with the same root node—as in (24)—neither [F] f-precedes [G] nor [G] f-precedes [F].⁵

⁵One possible exception to this are complex segments like diphthongs and prenasalized stops. In these cases, root nodes themselves can be seen as complex, which establishes a precedence relation among two different features linked to the same root node. I will address this further in section 8.5.4.

I postpone further discussion of formal properties of f-precedence until section 3.2.4. For now, the definition of f-precedence in (25) will be sufficient. If I illustrate the effects of this definition with the representation in (24), we see that [G] f-precedes [H]. However, [F] does not f-precede [G], because there is no root node associated with [G] but not with [F]. For the same reason, [G] does not f-precede [F]. In other words, in order to establish f-precedence between two features, there must be at least one root node associated with each of the features, but not the other feature.

- (25) F-precedence
 [G] f-precedes [H], iff
- (i) $\exists \times_i$ associated with [G] but not with [H],
and
 - (ii) $\exists \times_j$ associated with [H] but not with [G],
and
 - (iii) \times_i precedes \times_j .

F-precedence is a crucial ingredient of feature alignment constraints. Recall (22) and the fact that alignment constraints require a precedence relation between two categories. In the case of features such as these in (23), precedence relations among features can be established only via root nodes, which requires the notion of f-precedence. In (26), I repeat the featural alignment template and complement it with a definition.

- (26) Featural alignment
- a. $\ast\langle \text{Domain}, [\text{G}], [\text{H}] \rangle$ / 
 - b. Assign a violation mark for every triplet $\langle \text{Domain}, [\text{G}], [\text{H}] \rangle$, iff
 the *Domain* is associated with [G] and [H]
 and
 [G] f-precedes [H].

Another ingredient of the definition in (26) is the extension of association to the relationship between a domain and a feature. A domain is associated with a feature only if at least one of the root nodes of that domain is associated with that feature. I will return to this point in chapter 3, but for now suffice it to say that the constraint can be violated by all instances of the two dependent features associated with any root node of the domain. I will also revisit alignment constraints in sections 3.2.4 and 5.2.2. This is because I will restrict possible targeted structures and modify the representation of spreading features.

In this thesis, I show that alignment constraints similar to the one in (26) can model feature spreading better than other approaches to feature spreading. This is despite the fact that they require an additional concept of f-precedence. Another good argument in favor of alignment constraints based on Hyde (2008) is purely formal. The constraint template in (26) is categorical rather than gradient. Categorical constraints are violated maximally once per locus of violation. This is the case in the definition above, because a triplet is a locus of violation. Gradient constraints, on the other hand, can be violated more than once per locus of violation. We will see that the effect of Hyde's constraints is gradient (i.e. one constraint can assign multiple violation marks for one spreading feature), despite the fact that it is formally categorical (i.e., one constraint assigns no more than one violation mark per locus of violation). Gradient constraints have been shown to generate many unattested patterns (McCarthy 2003a; Hyde 2008). One such example is the Midpoint Pathology, which involves a pattern in which stress will fall on the syllable furthest apart from both edges of a prosodic word. In addition to better empirical coverage, Hyde's constraints also offer a purely theoretical advantage. Since categorical constraints can capture the effect of gradient constraints, a grammar that allows only categorical constraints is more parsimonious than one that allows both types of constraints (as argued by McCarthy 2003a).

In the remainder of this section, I apply Hyde's template to two cases of feature spreading. First, I analyze nasal harmony in Applecross by using a constraint that prefers spreading of nasality to all root nodes. This constraint outranks a faithfulness constraint against linking a feature. Second, I modify both variables in the alignment constraint and account for vowel harmony in Finnish. When only vowels are targeted by the alignment constraint, the lower ranked faithfulness constraint will prefer candidates with vowel harmony, leaving consonants unaffected.

Applecross Gaelic nasal harmony

Recall that in Applecross—(5), also repeated in (27) below—nasality spreads rightwards from an underlying nasal trigger. This process can be analyzed as [nasal] spreading (van der Hulst & Smith 1982; Walker 1998/2000). The trigger of the alternation is an underlying nasal vowel, which targets all following root nodes within the same prosodic word, while stops block spreading.

(27)	Nasal harmony in Applecross Gaelic (Ternes 1973:134,135)	
	ˈãhũç	‘neck’
	ˈšõhĩ	‘tame’
	friã·ṽ	‘root.PL.’
	kʰɔˈviã·t	‘how much/many?’
	tãṽ	‘ox, stag.PL’
	strãĩ·ṽ	‘to be luxurious’
	kʰõĩspaxk	‘wasp’
	tʰãhũšk	‘fool’

In what follows, I simplify the analysis in two ways. First, I focus on progressive assimilation alone. Bidirectional assimilation is analyzed in numerous subsequent sections, including 4.5.2, 6.3, 8.5.3, and 9. The approach can be straightforwardly extended to Applecross. Second, I will not analyze blocking by stops and instead assume spreading to all segments. Blocking in nasal harmony is discussed at length in section 6.6.1.

In terms of analysis, the spreading feature in Applecross is [nasal] and the domain is the prosodic word. Although all continuants are targeted, I will assume spreading to all segments, postponing the blocking pattern until chapter 6. The targeted structure is thus simply a root node. Hyde’s constraint schema allows for these three categories to be joined within a single constraint, defined in (28). Notice that f-precedence is applicable to a relationship between a root node and a feature, when they are not associated with one another. For expositional purposes, I use an abbreviated notation *PWd[nasal, ×] (“A root node must not f-precede [nasal] within a PWd”). I will use similar abbreviations throughout this thesis.

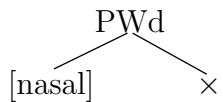
- (28) *PWd[nasal, ×]
- a. *⟨PWd, [nasal], ×⟩ / 
- b. Assign a violation mark for every triplet ⟨PWd, [nasal], ×⟩, iff
PWd is associated with [nasal] and ×
 and
 [nasal] f-precedes ×.

In Applecross, the alignment constraint *PWd[nasal, ×] outranks the relevant faithfulness constraint. From the viewpoint of Autosegmental Phonology what is being added when a feature spreads is not a feature, but rather an association. Faithfulness constraints to associations are widely used in OT literature that makes use of autosegmental representations—see Morén (1999/2001) for a full discussion of faithfulness constraints for associations, and Blaho (2008) for an extension to

segmental features. In this particular example, the faithfulness constraint being violated by candidates with spreading is a constraint against linking the feature [nasal] with a root node. The constraint $\text{DEPLINK}[\text{nasal}]$ in (29) is violated once by every association line to [nasal], which is present in the output, but not in the input.

(29) $\text{DEPLINK}[\text{nasal}]$ (cf. Itô et al. 1995; Myers 1997; Lombardi 1998; Morén 1999/2001; Archangeli & Pulleyblank 2002; Blaho 2008)

Let \times_i be an input root node and \times_o its output correspondent. Assign a violation mark, iff \times_o is associated with the feature [nasal] and \times_i is not.

The effect of the two constraints can be seen in tableau (30). The candidates differ in the number of epenthesized links (evaluated by the faithfulness constraint) or alternatively in the number of non-associated segments (evaluated by the markedness constraint). Candidate (a) contains a [nasal] segment that precedes three root nodes within a prosodic word. One prosodic word, one instance of [nasal], and four root nodes form four triplets. The triplets differ from each other only in the final element, which is the root node. The second, third and fourth segment and their corresponding triplets violate $\text{*PWd}[\text{nasal}, \times]$, because [nasal] f-precedes an \times within the same prosodic word. Recall (25) and the fact that association between a feature and a root node excludes f-precedence. If so, the first triplet $\langle \omega, [\text{nas}], a \rangle$ does not violate the constraint.

Candidate (b) contains only two oral segments, violating the alignment constraint only two times. The second segment, $[\tilde{\text{h}}]$ does not violate the constraint, because this segment is not f-preceded by the [nasal] feature, as association lines represent temporal alignment of a root node and a feature (or two features). Candidate (c) has one offending segment/triplet. Candidate (d) wins, since no \times is f-preceded by the feature [nasal], and $\text{*PWd}[\text{nasal}, \times]$ is not violated. This is irrespective of the fact that this candidate violates $\text{DEPLINK}[\text{nasal}]$ three times: once for each added association. Given the two constraints in (30), only two possible candidates could ever win: candidate (d) wins when alignment outranks faithfulness, while candidate (a) wins when the ranking is the reverse. Candidates (a) and (d) harmonically bound the remaining candidates.

(30) 'ãhũç̃ 'neck'

	[nas] ↓ / ã h u ç /	* ω [nasal, x]	DEPLINK[nasal]
a.	[nas] ↓ ã h u ç	$\langle \omega, [nas], h \rangle!$ $\langle \omega, [nas], u \rangle$, $\langle \omega, [nas], ç \rangle$	
b.	[nas] ↓ ã h̄ u ç	$\langle \omega, [nas], u \rangle!$ $\langle \omega, [nas], ç \rangle$	*
c.	[nas] ↓ ã h̄ ũ ç	$\langle \omega, [nas], ç \rangle!$	**
d. 	[nas] ↓ ã h̄ ũ ç̄		***

One prediction of the current approach is that assimilation patterns may differ in terms of the spreading feature, the targeted structure, and the domain. It is not hard to imagine many other constraints that are similar, but not identical to *PWd[nasal, x]. One option is to modify the spreading feature. For example, emphasis spread in SPalestinian (6) can be analyzed as regressive spreading of [RTR] that targets all segments (Davis 1995). If so, the relevant alignment constraint in SPalestinian contains [RTR] rather than [nasal]. Another variable that can be changed is the targeted structure. I will now show a constraint that differs from *PWd[nasal, x] in two variables: the spreading feature and the targeted structure. This is needed in the analysis of vowel harmony in Finnish (7), where only vowels act as targets, while consonants remain unaffected.

Finnish vowel harmony

Remember that Finnish—(7), repeated in (31) below—exhibits front/back vowel harmony. Front root vowels come with front suffix vowels, while back root vowels come with back suffix vowels; consonants are unaffected.

(31) Front/back harmony in Finnish (Ringen 1975/1988:77; Ringen & Heinämäki 1999:305)

næh-kø:n	'see-DIRECT.SG'	tul-kø:n	'come-DIRECT.SG'
næk-ø	'sight'	tul-o	'coming'
pøytæ-næ	'table-ESSIVE'	pouta-na	'fine weather-ESSIVE'

Here, I will analyze Finnish vowel harmony as spreading of the feature [back].⁶ There are at least three differences between Finnish and Applecross. First, the Finnish pattern involves the feature [back], while the Applecross pattern involves [nasal]. Second, the quality of affix vowels depends on root vowels in Finnish, while there is no such restriction in Applecross. In other words, vowel harmony in Finnish is morphologically conditioned: [back] can spread from a root, but not to a root. While this is a significant observation, I will leave it aside for now and revisit it in section 9.5. Because Finnish does not have clearly harmonizing prefixes (see section 5.5.1 for further discussion), I analyze Finnish harmony as progressive, which means it requires only one alignment constraint.

Third, only vowels are targeted in Finnish, while all root nodes are targeted in Applecross. This suggests that the alignment constraints in both languages differ. As we have seen, the targeted structure in Applecross is any root node. In Finnish, the targeted structure is any vowel. The alignment constraint schema predicts this typological distinction perfectly. In Finnish, the relevant constraint *PWd[back, vowel] in (32) contains a vowel instead of a root node. Consonants never appear in the constraint-violating triplets of this constraint.

- (32) *PWd[back, vowel]
- a. *⟨PWd, [back], vowel⟩ / $\begin{array}{c} \text{PWd} \\ \swarrow \quad \searrow \\ \text{[back]} \quad \text{vowel} \end{array}$
- b. Assign a violation mark for every triplet ⟨PWd, [back], vowel⟩, iff
PWd is associated with [back] and *vowel*
 and
 [back] f-precedes *vowel*.

The constraint (33) is parallel to the constraint (28) active in Applecross. What [nasal] is in Applecross, [back] is in Finnish. What × is in Applecross, *vowel* is in Finnish.

Tableau (32) shows the effect of *PWd[back, vowel]. Three candidates are shown, which represent one prosodic word each. The alignment constraint is violated by candidate (a), since it contains a vowel preceded by the [back] feature within the same word. The low ranked constraint DEPLINK[back] decides among the remaining two candidates. Candidate (b) violates DEPLINK[back] only once, while candidate (c) violates it two times. The faithfulness constraint DEPLINK[back] prefers candidates with the least spreading.

⁶I will also slightly abstract away from the data and simply assume that all vowels participate in vowel harmony (which is not the case). This will be revised in section 5.5.

(33) tulo ‘coming’

	[bk] / t u l - ø /	* ω [back,vowel]	DEPLINK[back]
a.	[bk] t u l ø	$\langle \omega, [\text{back}], \emptyset \rangle!$	
b. 	[bk] t u l ø		*
c.	[bk] t u l ^y ø		**!

We have now seen the effect of two similar, yet crucially different alignment constraints—*PwD[nasal, ×] and *PwD[back, vowel]. They differ from one another in two variables: the spreading feature (which may be [nasal] or [back]) and the targeted structure (which may be × or a vowel). Similarity and variability between the two constraints is also evident from the abbreviated notation. The constraint *PwD[nasal, ×] enforces spreading of the feature [nasal], while *PwD[back, vowel] enforces spreading of the feature [back]. Furthermore, the constraint *PwD[nasal, ×] prefers spreading to all segments, while *PwD[back, vowel] prefers spreading only to a subset of segments, namely vowels. The alignment constraint schema can be similarly modified further to include other domains, other spreading features and targeted structures. This is consistent with the cross-linguistic variation in assimilation, which was demonstrated in the empirical part of this chapter.

2.3 Summary

In this chapter, I look at different assimilation processes and established that they may differ in three basic variables: the spreading feature, the targeted structure, and the domain. I propose an analysis of feature spreading within Optimality Theory. This is based on a significant extension of a familiar approach that combines alignment with faithfulness constraints specific to features. I further demonstrate that all three basic parameters can be modeled using a single class of markedness constraints.

Chapter 3

Targets

So far we have looked at the basic parameters of feature spreading. I have argued that feature spreading involves three variables: a spreading feature, a targeted structure, and a domain. I have accounted for these variables by invoking a single class of markedness constraints. These constraints combine the three variables into a simple template: a constraint is violated by a triplet consisting of a spreading feature, a targeted structure and a domain. I examined two different alignment constraints, which differed from one another in their spreading features and targeted structures.

In this chapter, I look at further predictions of alignment constraints. I start off by revisiting alignment constraints (section 3.1) which sets the stage for subsequent analyses. Next, I focus on targets in feature spreading processes. Targets are determined by one of the alignment constraint parameters. This means that I will be looking at targeted structures of alignment constraints more closely. In section 3.2, I examine several feature spreading processes that have the same spreading feature, but which differ in their targeted structures. I show that targets always form a natural class. This class can be characterized in terms of a single category, which may be put in place of the targeted structure in an alignment constraint. I also argue that the relationship between the spreading feature and the targeted structure is not random. Instead, Con contains only a subset of all theoretically possible alignment constraints. The constraints with the same spreading feature are in a stringency relation, which means that the violation marks of one constraint are always a subset of the violation marks of the other constraint.

In section 3.3, I extend the typological findings to another spreading feature. This feature spreads only to a trigger that is strictly adjacent to the target. I account for this contrast between strictly local and non-local assimilation by invoking the factorial typology of alignment constraints. I further demonstrate that alignment constraints may also enforce dissimilation, depending on the ranking of faithfulness constraints. Unexpectedly, the same alignment constraints that re-

strict locality in assimilation do not produce the same restriction when it comes to dissimilation. That is, while non-local assimilation of some features is not attested, non-local dissimilation is, and alignment constraint typologies are able to capture this distinction.

In section 3.4, I enlarge the set of possible targeted structures by including morphological domains. I discuss two cases. In the first, a feature spreads across a morpheme boundary to a root only once. This pattern can be accounted for if an alignment constraint targets roots rather than particular segmental features. In the second case, a feature dissimilates in any morphologically complex word, but can surface in bare roots. This pattern is again entirely consistent with alignment constraints that target morphemes rather than features.

In summary, this section gives an overview of targets in feature spreading processes. The typological differences among them can be accounted for by proposed alignment constraints.

3.1 Introduction

A short overview of various patterns in chapter 2 gave evidence for three basic parameters of assimilation: a spreading feature, a targeted structure and a domain. These three variables can be joined into a single class of markedness constraints. The constraint template assigns a violation mark for a triplet of one domain, a spreading feature and a targeted structure, as long as certain other conditions are also met. In what follows, I examine alignment constraints in more detail. This is important since alignment constraints are a very powerful tool that can model not only assimilation but also other patterns, such dissimilation, derived environment effects, and static segment co-occurrence restrictions (morpheme structure constraints).

The alignment constraints in this thesis are based on a proposal by Hyde (2008). His alignment schemata refer to prosody. I extend his proposal to features. The alignment constraints contain three variables and two different kinds of relationships. One of these relationships is association between a domain and a feature. The other is precedence between a spreading feature and a targeted structure. The main challenge of the current implementation is that precedence among different features needs to be established indirectly. The easiest way to do that is via root nodes.

Recall the alignment constraint template in (23), which is repeated in (34) for convenience. The constraint assigns a violation mark for every triplet of a domain, [F] and [G], as long as (i) both [F] and [G] are associated with the domain and (ii) [F] f-precedes [G].

(34) Feature alignment (root nodes omitted)
 $*\langle \text{Domain}, [F], [G] \rangle$ / Domain

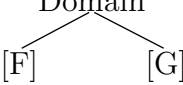

However, as we have already seen, the constraint template in (34) is somewhat misleading. This is because precedence relations between the two features cannot be established directly. In response to this challenge, I proposed that featural precedence is established via root nodes. This idea can be incorporated in the definition of the alignment constraint, such that root nodes are added between the domain and the two features, as in (35). However, the addition of root nodes is not entirely sufficient. What also matters that the features are exclusively linked to some root node. That is, a feature [F] must be associated with a root node that is not associated with [G]. In a parallel fashion, [G] must be associated with a root node that is not associated with [F]. The alignment constraint definition below contains greater detail, which makes the concept of f-precedence more explicit.

(35) Feature alignment (including root nodes)
 $*\langle \text{Domain}, [F], [G] \rangle$ / Domain

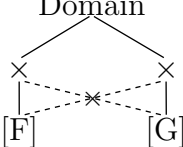

This full alignment template can be further modified. For example, the two features can be switched, such that precedence among their corresponding root nodes is reversed. This gives a constraint that prefers spreading in the opposite direction. We will see this effect in this and subsequent chapters. Another possible modification concerns one of the two features. I will now explore two modifications of [G].

The first option is to delete [G] entirely, as in (36). The altered constraint now has a root node as the targeted structure. Still, the restriction on association between [F] and the relevant root node \times_i remains. We have already seen a similar constraint, $*\omega[\text{nasal}, \times]$ (28), invoked in the analysis of Applecross nasal harmony.

(36) The targeted structure is a root node
 $*\langle \text{Domain}, [F], \times_i \rangle$ / Domain

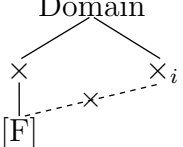

The second option is to replace the feature [G] with another targeted structure, such as a domain, as in (37). In this case, it is not the feature that is the final member of the violating set, but a domain. This constraint is violated if there

is a domain_B that is preceded by a root node linked to $[F]$, within the domain_A . Like the previous alignment constraints, the constraint with the domain as the targeted structure prefers spreading of $[F]$. However, unlike the previous cases, the constraint is equally satisfied by spreading to any root node associated with the domain_B . We will see the effects of such a constraint in section 3.4.

(37) The targeted structure is a domain
 $*\langle \text{Domain}_A, [F], \text{Domain}_B \rangle /$

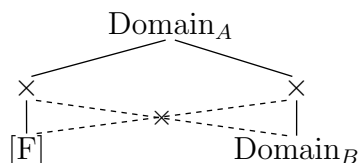

Another modification of the alignment constraint template would be to keep the part of the definition after the slash (/) constant, but modify the triplet itself. The triplet is an ordered set, which means that the sequence of individual constituents is not random. In the current context, the first element is a domain, followed by a spreading feature and a targeted structure. When the targeted structure is left out entirely, the constraint is violated only once per domain–feature pair, whereas the number of offending targeted structures does not matter. I will focus on this property of alignment constraints in chapter 5.4.

In the rest of this thesis, I will use an abbreviated definition of alignment constraints in which the root nodes between features and domains are omitted, as it is the case in (34). In classic Autosegmental Phonology, associations are strictly limited to connecting different levels of representations, which means that a feature may be associated with a root node or another, dependent feature. In this thesis, I assume no dependency among different features (section 2.2.1), hence the only remaining association is that between a feature and a root node. This is direct association. However, I have been consistently using association in another sense. A feature can be indirectly associated with another feature, if they are linked to the same root node. A feature is indirectly associated with a domain, if the feature and the domain are linked to the same root node. This second or indirect association is ingrained in the concept of alignment constraints, which require that two features are associated with the same domain.

By eliminating root nodes from the definition of alignment constraints, the notion of indirect association needs to be made explicit. To recap, a feature $[F]$ can be *directly* associated only with a root node. In contrast, a feature $[F]$ is *indirectly* associated with another feature $[G]$, if and only if there is a common root node that is associated with $[F]$ and $[G]$. The same applies to indirect association between a feature and a domain. A feature is associated with a domain (and vice versa) if and only if the feature is associated with at least one root node of the domain. I term this axiom Association by Proxy (38).

(38) Association by Proxy

- a. A feature [F] is associated with a feature [G], iff $\exists x$ that is associated with [F] and [G].
- b. A feature [F] is associated with a domain D , iff $\exists x$ that is associated with [F] and D .

Now that I have clarified what association means in the present context, I proceed by examining further predictions of alignment constraints.

3.2 Typology of targets

As we have just seen, the alignment constraint template is highly customizable. This is a good prediction, since assimilation patterns come in many different shapes and sizes. They involve different domains, spreading features and different targeted structures. However, not all theoretically possible assimilations are in fact attested. The aim of this section is to explore the relationship between a spreading feature and its target. I will argue that this relationship is not random, but has to conform to certain phonetic and typological restrictions.

In this section, I focus on three spreading patterns that involve a single feature, [Retracted Tongue Root]. SPalestinian has spreading to all segments (section 3.2.1), Twi has vowel harmony that targets only vowels (section 3.2.2), while Wolof shows spreading to non-high vowels only (section 3.2.3). What these examples show empirically is that targets form predictable sets. Some targets of RTR spreading imply other targets, but not the reverse. For example, if a language allows spreading to consonants, it will also allow spreading to vowels. This typological observation can be captured by alignment constraints that have [RTR] as the spreading feature and another feature as the targeted structure.

The theoretical point here is to show that the relationship between the spreading feature and targeted category is not random. I argue that active constraints in these three languages differ in the targeted structure, which follows straightforwardly from the alignment constraint template. In section 3.2.4, I revisit alignment constraints with particular attention to the typological differences in RTR spreading. I focus on featural precedence as a key ingredient of alignment constraints. With this formal property of alignment constraints clarified, I move on to the factorial typology of alignment constraints with [RTR] as the spreading feature (section 3.2.5). I show that these constraints are in a stringency relation and can generate only attested target patterns.

3.2.1 Southern Palestinian Arabic

Recall that in SPalestinian—(6), repeated in (39) below—pharyngealization spreads leftwards from an underlying trigger. The trigger of the alternation is an underlying pharyngealized segment, which targets all preceding root nodes within the same prosodic word.

(39)	Emphasis spread in Southern Palestinian Arabic (Davis 1995:473–474)
	BALLAAṢ ‘thief’
	ħAðð ‘luck’
	ʔABSAṬ ‘simpler’
	BAAṢ ‘bus’
	MAJAṢṢAṣiḥ̣ ‘it didn’t become solid’
	Ṭiin-ak ‘your mind’
	ʕAṬʕaan ‘thirsty’

This pattern can be analyzed as [RTR] spreading (Davis 1995). In this thesis, I use Hyde’s (2008) alignment schemata that refer to features (section 2.2.2). In this section, I am dealing with the distinction between targets and other segments (non-targets). This distinction is captured by the second variable of feature alignment constraints: the targeted structure. As we have seen in section 3.1, targeted structures can be features, domains or root nodes. When the targeted structure is a root node, all segments are targeted and may incur a violation mark. We have already seen this in Applecross (section 2.2.2), and the same is true for SPalestinian.

SPalestinian pharyngealization applies within a Prosodic Word and the spreading feature is [RTR]. Here I look at regressive spreading of RTR, which means that only root nodes preceding an [RTR] trigger violate the relevant alignment constraint. The alignment constraint schema allows for these parameters to be joined within a single constraint in (40). The relevant constraint has [RTR] as the spreading feature, a root node as the targeted structure, and the Prosodic Word as the domain.

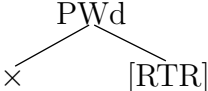
- (40) *PWd[×, RTR]
- a. *⟨PWd, [RTR], ×⟩ / 
- b. Assign a violation mark for every triplet ⟨PWd, [RTR], ×⟩, iff
PWd is associated with [RTR] and ×
 and
 × f-precedes [RTR].

The constraint in (40) differs in two ways from the constraints active in Applecross (28) and Finnish (32). I have already mentioned the difference between a targeted feature vs. a root node. The second difference is directional. In Applecross and Finnish the spreading feature *f*-precedes the targeted one. In SPalestinian the situation is the opposite: the targeted structure *f*-precedes the spreading feature.

In SPalestinian, the alignment constraint $*PWd[\times, RTR]$ outranks the relevant faithfulness constraint against linking, $DEPLINK[RTR]$ in (41).

(41) $DEPLINK[RTR]$

Let \times_i be an input root node and \times_o its output correspondent. Assign a violation mark, iff \times_o is associated with the feature $[RTR]$ and \times_i is not.

The effect of the two constraints can be seen in tableau (42). The candidates differ in the number of added links (evaluated by the faithfulness constraint) or alternatively in the number of non-associated segments (evaluated by the markedness constraint). Candidate (a) contains four non-RTR segments followed by an $[RTR]$ segment within a prosodic word. One prosodic word, one instance of $[RTR]$, and five segments form five triplets. The triplets differ from each other only in the final element, which is the root node. The first four segments and their corresponding triplets violates $*PWd[\times, RTR]$, because they *f*-precede an $[RTR]$ segment within the same prosodic word. Recall the fact that association and *f*-precedence are mutually exclusive (25). Because the final triplet $\langle \omega, \mathcal{S}, [RTR] \rangle$ involves a root node that is itself associated with a feature, it cannot violate the *f*-precedence condition of the alignment constraint. Candidate (b) contains only three non-RTR segments, violating the alignment constraint only three times. The fourth segment again does not violate the constraint, because this segment does not *f*-precede the $[RTR]$ feature, but it associated with it. Candidates (c) and (d) have two or one offending segment/triplet, respectively. Candidate (e) wins, since no root node *f*-precedes the feature $[RTR]$, and $*PWd[\times, RTR]$ is not violated. This is irrespective of the fact that this candidate violates $DEPLINK[RTR]$ four times: once for each added association.

(42) BAL:A:Ş ‘thief’

	$\begin{array}{c} \text{[rtr]} \\ \\ / \text{ b a l: a: } \text{Ş} / \end{array}$	$*\omega[\times, \text{RTR}]$	DEPLINK[RTR]
a.	$\begin{array}{c} \text{[rtr]} \\ \\ \text{b a l: a: } \text{Ş} \end{array}$	$\langle \omega, [\text{RTR}, \text{b}]! \langle \omega, [\text{RTR}, \text{a}], \langle \omega, [\text{RTR}, \text{l}], \langle \omega, [\text{RTR}, \text{a:}] \rangle \rangle \rangle \rangle$	
b.	$\begin{array}{c} \text{[rtr]} \\ / \quad \\ \text{b a l: A: } \text{Ş} \end{array}$	$\langle \omega, [\text{RTR}, \text{b}]! \langle \omega, [\text{RTR}, \text{a}], \langle \omega, [\text{RTR}, \text{l}] \rangle \rangle \rangle$	*
c.	$\begin{array}{c} \text{[rtr]} \\ / \quad / \quad \\ \text{b a L: A: } \text{Ş} \end{array}$	$\langle \omega, [\text{RTR}, \text{b}]! \langle \omega, [\text{RTR}, \text{a}] \rangle \rangle$	**
d.	$\begin{array}{c} \text{[rtr]} \\ / \quad / \quad / \quad \\ \text{b A L: A: } \text{Ş} \end{array}$	$\langle \omega, [\text{RTR}, \text{b}]! \rangle$	***
e.	$\begin{array}{c} \text{[rtr]} \\ / \quad / \quad / \quad / \quad \\ \text{B A L: A: } \text{Ş} \end{array}$		****

One prediction of the current approach is that assimilations may differ in terms of their spreading features, their targeted structures or their domain. Recall that I have proposed several such constraints in section 2.2.2. Any of the three variables can be modified. One option is to modify the spreading feature. For example, if we compare the constraint $*\text{PWd}[\text{back}, \text{vowel}]$ used for Finnish (32) with $*\text{PWd}[\times, \text{RTR}]$ in SPalestinian, we see that they involve different spreading features. Another variable that can be changed is the targeted structure. For instance, $*\text{PWd}[\text{back}, \text{vowel}]$ has a different targeted structure than $*\text{PWd}[\times, \text{RTR}]$. The targeted structure makes it possible for all segments to fall into two groups: targets and non-targets. Targets can form triplets that violate the markedness constraint, while non-targets cannot. The low ranked faithfulness constraint will prefer candidates with fewest association lines.

I now move on to another constraint that differs from $*\text{PWd}[\times, \text{RTR}]$ only in the targeted structure. This is needed in the analysis of [RTR] vowel harmony in Twi (10), where only vowels act as targets, while consonants remain unaffected.

3.2.2 Twi

Remember that Twi—(10), repeated and expanded in (43) below—exhibits tongue root vowel harmony. The tongue root position of affix vowels depend on root vowels. Lax affix vowels appear with lax root vowels, while tense affix vowels appear with tense root vowels. Consonants remain unaffected.

(43)	Tongue root harmony in Twi (Berry 1957:127–128,130)			
	biri	‘black’	o-biri	‘3P-black’
			wu-biri	‘2P-black’
	biri	‘red’	ɔ-biri	‘3P-red’
			wu-biri	‘2P-black’
	se	‘say’	o-se	‘3P-say’
			o-be-se	‘3P-FUT-say’
	sɛ	‘resemble’	ɔ-sɛ	‘3P-resemble’
			ɔ-bɛ-sɛ	‘3P-FUT-resemble’
	firi	‘lend, borrow’	mi-be-firi-i	‘1P-FUT-borrow-it’
	firi	‘fail, miss’	mi-bɛ-firi-i	‘1P-FUT-miss-it’

I analyze Twi vowel harmony as spreading of the feature [RTR]. There are at least two differences between Twi and SPalestinian. First, the value of [RTR] of the affix vowel depends on the root vowel in Twi, while there is no such restriction in SPalestinian. In other words, vowel harmony is morphologically conditioned: [RTR] can spread from a root, but not to a root. Recall that we have seen this pattern before in Finnish (section 2.2.2). However, while Finnish has only suffixes, Twi has both prefixes and suffixes. This means that Twi harmony should be analyzed as bidirectional. Bidirectional spreading can be seen as a combination of two processes, leftward and rightward spreading, and thus requires two alignment constraints. My aim in this section is to show the effect of a single alignment constraint, so I will limit this demonstration to regressive spreading. The additional morphological factors will be analyzed in section 9.5.2.

Second, only vowels are targeted in Twi, while all segments are targeted in SPalestinian. This disparity reflects the difference in the alignment constraints. As we have seen, the targeted structure in SPalestinian is any root node. In Twi, on the other hand, the targeted structure is any vowel. The alignment constraint schema predicts this typological distinction perfectly. In Twi, the relevant constraint *PWd[V, RTR] in (44) contains a vowel instead of a root node. Consonants are never a part of the constraint-violating sets.

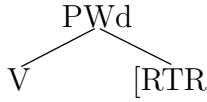
- (44) *PWd[V, RTR]
- a. *⟨PWd, [RTR], V⟩ / 
- b. Assign a violation mark for every triplet ⟨PWd, [RTR], V⟩, iff
PWd is associated with [RTR] and *V*
 and
V f-precedes [RTR].

Note that *vowel* is not considered a feature according to most feature theories. In this thesis, *vowel* appears only as the targeted structure of the alignment constraint, but not as a spreading feature. We have already seen a root node in that position. Furthermore, other morphological and prosodic domains can also be targeted. Hence, it is not necessary to assume that [vowel] is a phonological feature. What is required, however, is some way to refer to a set of all vowels. One solution is to call [vowel] a feature. Another solution would be to say that vowels can be a targeted structure, while remaining agnostic about whether there is a feature common to all vowels, but not to consonants. This second option is further supported by the fact that constraints must be able to distinguish vowels from consonants. In other words, there must be a way to refer to vowels, even if [vowel] is not a feature. In what follows, I will use [vowel] as a feature, while keeping in mind that at least formally this needs not to be a feature. All that [vowel] denotes is set of all vowels to the exclusion of consonants.¹

Tableau (45) shows the effect of *PWd[V, RTR]. Given Richness of the Base, inputs with one, two or more instances of [RTR] need to be considered. Here I will account for an input with a single instance of [RTR] on the final root vowel. The alignment constraint is violated by candidates (a–c), since they contain non-RTR vowels followed by the [RTR] feature within the same word. The low ranked constraint DEPLINK[RTR] decides among the remaining candidates. Candidate (d) violates DEPLINK[RTR] only twice, while candidate (e) violates it four times. The faithfulness constraint DEPLINK[RTR] prefers candidates with least spreading.

¹Traditional features like [–consonantal] and [+syllabic] cannot be used here. First, the feature [–consonantal] is common to vowels and glides, but the latter should instead pattern with consonants. Second, the feature [+syllabic] would predict spreading to all syllabic segments (vowels and consonants alike), while non-syllabic consonants would not be targeted. Such patterns are not attested.

(45) ɔbiri ‘red’

		* ω [V,RTR]	DEPLINK[RTR]
a.		$\langle \omega, [RTR], o \rangle! \langle \omega, [RTR], i \rangle$	
b.		$\langle \omega, [RTR], o \rangle! \langle \omega, [RTR], i \rangle$	*
c.		$\langle \omega, [RTR], o \rangle!$	**
d.			**
e.			***!*

We have now seen the effect of two similar alignment constraints—*PWd[\times , RTR] and *PWd[V, RTR]. The only difference among these two constraints is the targeted structure (which may be a feature or a root node). The constraint *PWd[\times , RTR] forces spreading to all segments, while *PWd[V, RTR] forces spreading only to a subset of segments, regardless of what the trigger is. In SPalestinian, [RTR] spreading targets all segments, while in Twi the same feature targets only vowels.² Moreover, the faithfulness constraint DEPLINK[RTR] has a stronger role in Twi compared to SPalestinian. In the latter, alignment prefers the candidate with spreading to all segments, whereas faithfulness cannot overrule that. In Twi, on the other hand, a candidate with total spreading and one with spreading only to vowels fare equally on the alignment constraint *PWd[V, RTR]. The faithfulness constraint DEPLINK[RTR] is crucial here in that it prefers least spreading and thus prefers the candidate with spreading to vowel over the one with total spreading. This effect of the low ranked DEPLINK[RTR] is an instantiation of the Emergence of the Unmarked.

One way of highlighting the difference between the two languages is through transparent segments. We have seen that SPalestinian has no transparent segments, while Twi has transparent consonants. A segment is transparent when it satisfies two conditions: it remains unaffected by spreading and does not terminate spreading. For example, Twi consonants are transparent because they remain

²The alignment constraint *PWd[V, RTR] prefers spreading to vowels regardless of what the trigger is. This predicts languages in which [RTR] spreads from a consonant trigger to vowels across other consonants. Such patterns are attested, for instance in Salish languages (Bessell 1998).

unaffected by spreading of the feature [RTR] and do not interfere with spreading. This situation can be straightforwardly represented within Autosegmental Phonology. As we have seen, transparent segments do not alternate. Thus, we have to assume that transparent segments are either (i) always associated with the spreading feature or that (ii) they cannot be associated with the feature.

The first option is to say that transparent segments are always associated with a feature. While such a solution seems reasonable at first, it faces at least two challenges. If transparent consonants in Twi were always associated with [RTR], we would expect that they would not differ from vowels that are associated with [RTR]. Vowels show spreading, so consonants should, too. This predicts that any word with at least one consonant always contains only tense vowels, while words without consonants could either have tense or lax vowels. This is clearly not what happens in Twi (43), or any language (this will be further discussed in section 3.2.4 below). The second challenge is that vowel harmony applies independently of consonants. Hence, if [RTR] is linked to a consonant and vowel harmony applies, we would have an instance of [RTR] linked to two vowels, while another [RTR] would be linked to the intervening consonant. This situation leads to crossing association lines, which is contrary to the basic assumptions of Autosegmental Phonology (see Hammond 1988; Sagey 1988). Thus, the claim that transparent consonants are always [RTR] needs to be rejected over the alternative, which is that consonants in Twi are not linked to [RTR].

This line of reasoning leads to a more general conclusion that no transparent segment will ever be exclusively linked with an instance of the spreading feature. Furthermore, they are not targets and cannot be associated with the spreading feature. We can then conclude that transparent segments are instead skipped by the spreading feature. In (46), we see a rule that spreads [F] from \times_1 to \times_3 and \times_4 . This rule skips the second segment; \times_2 is transparent.

(46) Transparency as a gapped configuration

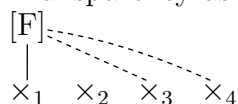

The gapped configuration in (46) is exactly what happens in Twi. Consonants are transparent and skipped by [RTR]. However, the representation in (46) is to some extent misleading: it lacks information about other features. This turns out to be a crucial piece of information. What sets transparent segments like \times_2 apart from targets like \times_3 and \times_4 is not random. We have already seen this situation in Twi. In particular, the set of targets in Twi forms a natural class—they are all vowels. In fact, targets can always be characterized in terms of a common structure, which can be a feature, a root node or a domain.

This empirical observation is tightly connected with the proposed alignment constraints. One of the parameters in these constraints is the targeted structure. Thus, only segments containing the targeted structure could potentially incur violations of such markedness constraints. When the targeted structure is a root node, any segment will be targeted, as we have seen in SPalestinian. When the targeted structure is a vowel, only vowels will be targeted. All other segments, on the other hand, will be transparent. Furthermore, the targeted structure can be further modified such that only a subset of vowels are targeted. This is in fact what is attested. In Wolof, only non-high vowels are targeted, and all other segments—high vowels and consonants—are transparent. Wolof is discussed next.

3.2.3 Wolof

Wolof (47) has RTR vowel harmony that targets only non-high vowels, ignoring not only consonants but also high vowels (Ka 1988/1994; Archangeli & Pulleyblank 1994; Kenstowicz 1994; Pulleyblank 1996; Krämer 2003). In (47-a) we see that root vowels determine the suffix vowel: tense root vowels are followed by tense suffix vowels, while lax root vowels are followed by lax suffix vowels. However, (47-b) shows that high vowels are not targeted and do not alternate. Finally, the data in (47-c) reveal that if the root-final vowel is a high vowel, the first preceding root vowel determines what the suffix vowel will be. We can conclude that high vowels are not targeted by tongue root harmony in Wolof, and can be skipped in the process.

(47) Wolof tongue root harmony (Ka 1988/1994:13–16,31–35)

a.	door- <u>e</u>	‘to hit with’	xɔɔl- <u>ɛ</u>	‘to look with’
	reer- <u>e</u>	‘to be lost in’	dɛm- <u>ɛ</u>	‘to go with’
	gən- <u>e</u>	‘to be better in’	xam- <u>ɛ</u>	‘to know in’
	ʒeeg- <u>o</u>	‘step’	mɛl- <u>ɔ</u>	‘aspect’
	sofoor- <u>əm</u>	‘his/her driver’	tɔɔl- <u>am</u>	‘hie/her field’
	bəgg- <u>ante</u>	‘to love e.o.’	raw- <u>antɛ</u>	‘to complete’
b.	wedd- <u>i</u>	‘to straighten up’	lɛmm- <u>i</u>	‘to unfold’
	ɲoox- <u>it</u>	‘residue’	dɔg- <u>it</u>	‘bit’
	dəkk- <u>si</u>	‘to come and live’	wax- <u>si</u>	‘to come and say’
	lett- <u>u</u>	‘to braid hair’	sɛɛt- <u>u</u>	‘to look in the mirror’
	sələm- <u>u</u>	‘to wash face’	raxas- <u>u</u>	‘to wash hands’
	deg- <u>lu</u>	‘to listen’	tɛɛj- <u>lu</u>	‘to act with caution’

c.	lett <u>u</u> -leen	‘braid your hair!’	tɛkk <u>i</u> -lɛɛn	‘untie!’
	toxi <u>i</u> -leen	‘go and smoke!’	sɔppi <u>i</u> -lɛɛn	‘change!’
	gəst <u>u</u> -leen	‘do research!’	wat <u>u</u> -lɛɛn	‘have a haircut!’
	seenu <u>u</u> -woon	‘tried to spot’	tɛɛru <u>u</u> -wɔɔn	‘welcomed’
	soox <u>i</u> -woon	‘went and sank’	xɔlli <u>i</u> -wɔɔn	‘peeled’
	təri <u>i</u> -woon	‘went and slept’	raxasi <u>i</u> -wɔɔn	‘went and cleaned’

Wolof can be analyzed as spreading of the feature [RTR]. This makes it similar to SPalestinian and Twi. The crucial difference is in what features are being targeted. Wolof presents an even more restricted situation than the other two languages; RTR harmony targets only non-high vowels. In the present context, this indicates that the targeted structure of the alignment constraint is a feature common to non-high vowels. A privative feature common to all non-high vowels is [open] (cf. Clements & Hume 1995). Similar features have been proposed in other works that use privative features. For example, [A] is such a “feature” in Element Theory (Kaye et al. 1985, 1990; Harris & Lindsey 1995), while V-manner[open] is the equivalent in the Parallel Structures Model (Morén 2003, 2006b). Here, the privative feature [open] is directly parallel to the binary feature [–high].

The second property by which Wolof differs from the other two languages is directionality. SPalestinian has leftward spreading of [RTR], Twi has bidirectional spreading, while Wolof has rightward spreading (from root to suffix). The alignment constraint *PWd[RTR, open] in (48) forces spreading of [RTR] only to [open] vowels within a word.³ This constraint cannot be violated by any other segment; high vowels or consonants will never form a violating triplet.

(48) *PWd[RTR, open]

- a. *⟨PWd, [RTR], [open]⟩ / $\begin{array}{c} \text{PWd} \\ \swarrow \quad \searrow \\ \text{[RTR]} \quad \text{[open]} \end{array}$
- b. Assign a violation mark for every triplet ⟨PWd, [RTR], [open]⟩, iff PWd is associated with [RTR] and [open] and [RTR] f-precedes [open].

Tableau (49) shows the effect of *PWd[RTR, open]. Here I will account for an input with a single instance of [RTR] on the leftmost non-high root vowel. Only candidate (a) violates the alignment constraint, since it contains an [e:], which is (i) an open and non-RTR vowel and (ii) f-preceded by an [RTR] segment within

³The vowel harmony actually extends beyond prosodic words, but this pattern is influenced by syntactic properties (Ka 1988/1994:48ff.). For example, demonstratives are subject to vowel harmony from the noun. The actual domain seems to be the phonological phrase, but I leave this fact aside.

the same word. The low ranked constraint $\text{DEPLINK}[\text{RTR}]$ decides among the remaining candidates. Candidate (c) violates $\text{DEPLINK}[\text{RTR}]$ two times, while candidate (d) violates it four times. The remaining candidate (b) wins. The faithfulness constraint $\text{DEPLINK}[\text{RTR}]$ prefers candidates with least spreading.

(49) $\text{t}\epsilon\text{kki-l}\epsilon\text{en}$ ‘untie!’

	$\begin{array}{c} [\text{rtr}] \\ \\ / \text{t} \ \epsilon \ \text{k: i - l} \ \epsilon: \text{n} / \end{array}$	$*\omega[\text{RTR,open}]$	$\text{DEPLINK}[\text{RTR}]$
a.	$\begin{array}{c} [\text{rtr}] \\ \\ \text{t} \ \epsilon \ \text{k: i l} \ \epsilon: \text{n} \end{array}$	$\langle \omega, [\text{RTR}, \epsilon:] \rangle!$	
b. 	$\begin{array}{c} [\text{rtr}] \\ \quad \curvearrowright \\ \text{t} \ \epsilon \ \text{k: i l} \ \epsilon: \text{n} \end{array}$		*
c.	$\begin{array}{c} [\text{rtr}] \\ \quad \curvearrowright \quad \curvearrowright \\ \text{t} \ \epsilon \ \text{k: i l} \ \epsilon: \text{n} \end{array}$		**!
d.	$\begin{array}{c} [\text{rtr}] \\ \quad \curvearrowright \quad \curvearrowright \quad \curvearrowright \\ \text{t} \ \epsilon \ \text{K: i L} \ \epsilon: \text{N} \end{array}$		**!***

The alignment constraint is crucial to this analysis. In particular, the targeted structure is [open]. Consequently, only open vowels potentially incur violation marks by appearing in violating triplets. Other segments cannot violate the constraint. Faithfulness decides among the remaining candidates, preferring spreading to fewest segments.

To put it differently, a candidate with feature spreading is less marked than a candidate with no spreading. Such markedness is evaluated by an alignment constraint. Associated targets improve a candidate’s standing with respect to the alignment constraint, while non-associated segments containing the targeted structure increase the candidate’s violability. Transparent segments (consonants and high vowels in Wolof) pattern with targets in that they do not incur violation marks. It is faithfulness that distinguishes transparent segments from targets. While both types of segments violate the faithfulness constraint $\text{DEPLINK}[\text{F}]$, violations by targets are trumped by the spreading preference of the high ranked alignment constraint. This is because targets contain the relevant targeted structure, while transparent segments do not.

We have now seen three languages with RTR spreading. If we compare them, we see that they show an implicational pattern. SPalestinian spreads the feature [RTR] to consonants and vowels, Twi spreads it to vowels, and Wolof spreads it to non-high vowels only. To the best of my knowledge, no language spreads [RTR] from a vowel to some consonants, while a class of vowels remains transparent. The converse situation, in which [RTR] spreads from a consonant to only non-

high vowels is attested in various Interior Salish languages (Bessell 1998). In the following sections, I demonstrate how the current approach is able to capture these generalizations. In particular, the strategy relies on the possible constraints containing [RTR] as the spreading feature. I will show that the current approach based on such alignment constraints can be restricted such that it predicts only attested languages—including SPalestinian, Twi, and Wolof.

3.2.4 Alignment revisited

The reviewed set of languages with the same spreading feature, but with different targeted structures allows further insight into how alignment constraints work.

Recall section 2.2.2, where I have shown that alignment constraints used in this thesis are formally quite different from classic alignment constraints (McCarthy & Prince 1993a,b). In particular, the proposed constraints are formally categorical (each triplet incurs maximally one violation mark), but have a gradient effect (each potential target participates in a violating triplet). Furthermore, the proposed constraints refer to three categories (a feature, a targeted structure and a domain) rather than two (a feature and a domain). The rationale behind classic alignment constraints is in that a feature needs to be aligned to an edge of some prosodic domain. This idea is also contained within the new constraints, which prefer spreading to all segments of a particular kind between a trigger and an edge of a domain.

However, the new constraints come with an additional twist, which is that spreading may target only a subset of segments. In fact, this is not a radically novel concept, since it has been put forward in connection to classic alignment constraints. This is specifically spelled out by McCarthy (2003a). The extended alignment constraint template in (50) has five variables: three categories and two edges.

- (50) Expanded schema for alignment constraints (McCarthy 2003a:78)
- $$\text{ALIGN}(\text{Cat1}, \text{Edge1}; \text{Cat2}, \text{Edge2}; \text{Cat3}) \equiv$$
- $$\forall \text{Cat1} \text{ if } \exists \text{Cat2}, \text{ assign one violation-mark } \forall \text{Cat3} \text{ that intervenes}$$
- $$\text{between Edge1 of Cat1 and the nearest Edge2 of some Cat2,}$$
- where
- $$\text{Cat1, Cat2 are prosodic or morphological categories, Cat3 is a}$$
- $$\text{prosodic category and Edge1, Edge2} \in \{\text{Right, Left}\}.$$

In practice, the categories used were primarily prosodic and their extension to features has not been made explicit. The only exception are constraints responsible for vowel harmony where only vowels frequently incurred violation marks. For example, Pulleyblank (1996) marks violation marks for alignment only on vowels.

The current approach makes the concept of targeted structures as the third category in alignment constraints explicit. This means that the rationale behind alignment constraints is considerably shifted. On the one hand, what matters is aligning a feature to a domain. On the other hand, only some segments are targeted. The question here is how these segments can be characterized. The claim I am advancing is that these segments are predictable. Specifically, a feature may spread only to those segments where it will be realized prominently. This prominence can be captured with a targeted structure and its relationship with the spreading feature. This relationship is not random, but grounded typologically and phonetically. Sometimes the typological and phonetic grounds coincide. For example, we know that [ATR] correlates with high vowels, which means that the opposite feature, [RTR] correlates with non-high/open vowels (Archangeli & Pulleyblank 1994). The typological consequence of this is that there will be alignment constraints with [RTR] as the spreading feature and vowel or [open] as the targeted structures, but there is no constraint with [RTR] as the spreading feature and consonant or [high] as the targeted structures.

Recall that the short typological overview of RTR spreading in section 3.2 includes three alignment constraints. In SPalestinian, [RTR] targets all segments; the active alignment constraint $*\text{PWd}[\times, \text{RTR}]$ has the root node in the place of the targeted feature. In Twi, [RTR] targets vowels; the active alignment constraint $*\text{PWd}[\text{vowel}, \text{RTR}]$ refers to vowels. Finally, in Wolof, [RTR] targets only non-high vowels; the active alignment constraint $*\text{PWd}[\text{RTR}, \text{open}]$ refers to the feature [open]. If we ignore directionality, these three constraints are in a stringency relation. Any output that violates $*\text{PWd}[\text{open}, \text{RTR}]$ will also violate $*\text{PWd}[\text{vowel}, \text{RTR}]$, and any output that violates $*\text{PWd}[\text{vowel}, \text{RTR}]$ will also violate $*\text{PWd}[\times, \text{RTR}]$. This is because the set of segments containing [open] is a subset of all vowels, which are in turn a subset of all segments. To show that, I will revisit the Wolof example and use all three constraints.

In (47) we have seen that Wolof displays root-to-affix RTR harmony, which targets only [open] vowels. In (49) we have further seen that the high ranked alignment constraint in Wolof is $*\omega[\text{RTR}, \text{open}]$, which outranks $\text{DEPLINK}[\text{RTR}]$. However, constraints in OT are universal, which means that many other constraints are also possible in Wolof. With respect to RTR spreading, we must also consider at least two other alignment constraints: $*\omega[\text{RTR}, \text{vowel}]$ (parallel to the constraint used for Twi) and $*\omega[\text{RTR}, \times]$ (parallel to the constraint active in SPalestinian). In Wolof, these must be ranked below $\text{DEPLINK}[\text{RTR}]$. The crucial point here is the evaluation of these two constraints, which is shown in (51).

(51) tɛkki-lɛɛn ‘untie!’

$\begin{array}{c} [\text{rtr}] \\ \\ / t \ \varepsilon \ k: \ i - l \ e: \ n / \end{array}$	$*\omega[\text{RTR},\text{op}]$	DEPLK[RTR]	$*\omega[\text{RTR},\text{V}]$	$*\omega[\text{RTR},\times]$
a. $\begin{array}{c} [\text{rtr}] \\ \\ t \ \varepsilon \ k: \ i \ l \ e: \ n \end{array}$	$\langle \omega, [\text{RTR}, e:] \rangle!$		$\langle \omega, [\text{RTR}, i] \rangle$ $\langle \omega, [\text{RTR}, e:] \rangle$	$\langle \omega, [\text{RTR}, k:] \rangle$ $\langle \omega, [\text{RTR}, i] \rangle$ $\langle \omega, [\text{RTR}, l] \rangle$ $\langle \omega, [\text{RTR}, e:] \rangle$ $\langle \omega, [\text{RTR}, n] \rangle$
b. $\begin{array}{c} [\text{rtr}] \\ \\ t \ \varepsilon \ k: \ i \ l \ \varepsilon: \ n \end{array}$		*	$\langle \omega, [\text{RTR}, i] \rangle$	$\langle \omega, [\text{RTR}, k:] \rangle$ $\langle \omega, [\text{RTR}, i] \rangle$ $\langle \omega, [\text{RTR}, l] \rangle$ $\langle \omega, [\text{RTR}, n] \rangle$
c. $\begin{array}{c} [\text{rtr}] \\ \\ t \ \varepsilon \ k: \ i \ l \ \varepsilon: \ n \end{array}$		**!		$\langle \omega, [\text{RTR}, k:] \rangle$ $\langle \omega, [\text{RTR}, l] \rangle$ $\langle \omega, [\text{RTR}, n] \rangle$
d. $\begin{array}{c} [\text{rtr}] \\ \\ t \ \varepsilon \ K: \ i \ L \ \varepsilon: \ N \end{array}$		**!***		

Let us start with the winning candidate (b). This candidate shows spreading of [RTR] only to the rightmost [open] vowel, skipping three segments—two consonants and one high vowel. The high ranked constraint $*\omega[\text{RTR}, \text{open}]$ is not violated, because the [open] vowel does not follow [RTR]. Specifically, what candidate (b) shows is that [RTR] is associated with the open vowel [ɛ:]. Crucially, the markedness constraint $*\omega[\text{RTR}, \text{open}]$ requires that [RTR] f-precedes [open]. The definition of f-precedence in (25) excludes association of [RTR] and [open] to the same root node. This is because association denotes temporal alignment of a feature and a root node. By transitivity, two features associated with the same root node are also perfectly aligned with one another. If so, then it is not the case that [RTR] f-precedes [open]. Hence, the f-precedence condition of the alignment constraint $*\omega[\text{RTR}, \text{open}]$ is not met, and the constraint is not violated. High vowels and consonants also do not contain an [open] feature, hence they cannot participate in the violating triplets and vacuously satisfy the constraint.

What about the other two alignment constraints? The first one, $*\omega[\text{RTR}, \text{vowel}]$, penalizes triplets in which [RTR] f-precedes a vowel (within a Prosodic Word). Clearly, the open vowel [ɛ:] does not violate this constraint, for the same reasons it does not violate $*\omega[\text{RTR}, \text{open}]$. That is, [ɛ:] is associated with [RTR] and association excludes f-precedence. The situation with the remaining high vowel [i] is not as apparent. On the one hand, [i] is a vowel that may participate in a violating triplet $\langle \omega, [\text{RTR}, i] \rangle$. It turns out it does participate, because [RTR] is associated with a root node that precedes [i], and thus [RTR] f-precedes [i]. On

the other hand, the high vowel [i] also f-precedes the particular instance of the feature [RTR], because [i] is followed by a root node associated with [RTR]. This may seem somewhat paradoxical. How can a feature [F] f-precede another feature [G], while [G] also f-precedes [F] at the same time?

The answer to this puzzle is in that f-precedence is a very different relation than (normal) precedence. Recall section 2.2.2 and discussion regarding precedence. In Autosegmental Phonology, precedence is established between root nodes or between like features (Goldsmith 1976). For any two root nodes, there is a unique precedence relation: one always precedes the other. Similarly, for any two instances of the same feature, one must precede the other. More formally, precedence relation (henceforth marked as $<$) has the following properties: it is asymmetrical, transitive and irreflexive. Precedence is asymmetrical because if (a segment) $a < b$ then it cannot be that $b < a$. Second, precedence is transitive because if $a < b$ and $b < c$ then it must also be true that $a < c$. Third, precedence is irreflexive because no segment can precede itself; $a < a$ can never be true.

F-precedence (henceforth marked as \triangleleft) is a rather different relation both in its formal properties and empirical consequences. This is based on several facts. First, f-precedence is a relation between two different features or a feature and a root node. This is directly parallel to association, which also between a feature and a root node, and indirectly between two features—see Association by Proxy (38). Any two elements that are associated with one another are not in an f-precedence relation. If so, two features do not necessarily f-precede one another, as we have seen in (51). Second, f-precedence is established indirectly via precedence. More specifically, f-precedence of two features is determined via the root nodes which they are associated with. This is evident from the definition of f-precedence in (25). I repeat the definition in (52).

- (52) F-precedence (\triangleleft)
 $[G] \triangleleft [H]$, iff
- (i) $\exists \times_i$ associated with [G] but not with [H],
and
 - (ii) $\exists \times_j$ associated with [H] but not with [G],
and
 - (iii) $\times_i < \times_j$.

I demonstrate the full scope of this definition of f-precedence in (52) with examples in (53). When [G] and [H] are associated with the same segment (and no other segment) as in (53-a), neither feature f-precedes the other. This is because (52-i) and (52-ii) require that at least one root node is associated exclusively with each feature (but not with the other). The representation in (53-b), however, does fulfill the two conditions: each of the two features is associated with a root node that

the other feature is not associated with. More specifically, \times_2 is associated with [G] but not [H] and precedes \times_4 , which is associated with [H], but not [G]. Hence, $[G] \triangleleft [H]$. The gapped configuration in (53-c) presents an even more complex situation. Since (i) \times_5 is associated with [G], but not by [H], (ii) [H] is associated with \times_6 , and (iii) \times_5 precedes \times_6 , then it must be true that $[G] \triangleleft [H]$. Conversely, it is also true that $[H] \triangleleft [G]$, because \times_6 precedes \times_7 .

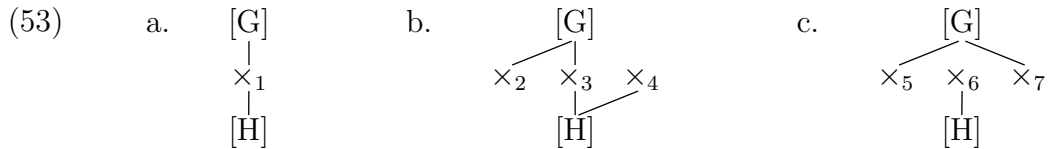

These examples suggest that at least two formal properties of f-precedence are different than that of precedence. F-precedence is neither symmetrical nor asymmetrical, neither transitive nor intransitive, but it is irreflexive. F-precedence is not symmetrical because if $G \triangleleft H$, then it may or may not be true that $H \triangleleft G$. F-precedence is also not asymmetrical because if $G \triangleleft H$, then it is not the case that $H \triangleleft G$ is always false. This differs from precedence, which is asymmetrical. Second, f-precedence is neither transitive nor intransitive (i.e. it is non-transitive) because if $G \triangleleft H$ and $H \triangleleft I$, then it may or may not be true that $G \triangleleft I$. This also differs from precedence, which is transitive. Third, f-precedence is irreflexive because no single instance of a feature can precede itself. That is, $G \triangleleft G$ can never be true if G is the very same autosegment.

We can thus conclude that f-precedence is a plausible binary relation between two features. By extension, f-precedence is also possible between a feature and a root node, or between a feature and a prosodic/morphological domain.

From the discussion above we can also conclude that two features can both f-precede one another—as it is the case in (53-c). This has implication for RTR harmony in Wolof. Recall that the current discussion is about the constraint $*\omega[\text{RTR}, \text{vowel}]$ and its effects on Wolof vowel harmony in tableau (51). When [RTR] f-precedes a tense vowel, the constraint $*\omega[\text{RTR}, \text{vowel}]$ is always violated. It does not matter that a tense vowel also f-precedes [RTR] as it is the case in candidate (b), where [i] is skipped by the feature [RTR]. At the same time, the constraint $*\omega[\text{RTR}, \text{vowel}]$ cannot be violated by a consonant.

This brings us to the final alignment constraint in (51), $*\omega[\text{RTR}, \times]$. This constraint is violated four times by candidate (b). First, the violating triplet $\langle \omega, [\text{RTR}], n \rangle$ is not problematic, since [RTR] clearly f-precedes the final [n]. The remaining three violation marks are caused by segments that come after the trigger, which is associated with [RTR], but before the target, which is also associated with the same instance of [RTR]. These segments form violating triplets of the constraint $*\omega[\text{RTR}, \times]$ for the same reason that [i] violates $*\omega[\text{RTR}, \text{vowel}]$, as we have seen

above. Specifically, it is enough that [RTR] f-precedes these segments, and the fact that it also follows them does not matter. In total, candidate (b) violates $*\omega$ [RTR, \times] four times.

If we then compare all three alignment constraints, we see that they are in a stringency relation. Any violation of $*\omega$ [RTR, open] implies a violation of $*\omega$ [RTR, vowel], which in turn implies a violation of $*\omega$ [RTR, \times]. This is also true for all candidates in (53). For example, because candidate (a) violates $*\omega$ [RTR, open] once, it will also violate the other two alignment constraints. This candidate also violates $*\omega$ [RTR, vowel] twice, which means it will also violate $*\omega$ [RTR, \times] at least twice.

3.2.5 Factorial typology

We have now looked at an evaluation of a single class of constraints that have [RTR] as the spreading feature and the Prosodic Word as the domain. The Wolof pattern in (51) surfaces when the constraint preferring spreading to [open] vowels outranks $\text{DEPLINK}[\text{RTR}]$, which in turn outranks the other two alignment constraints, which prefer spreading to vowels and all root nodes. However, tableau (51) represents only a subset of possible candidates. These candidates all adhere to the typological observations about RTR harmony, based on languages like Wolof, Twi and SPalestinian. One can easily imagine other candidates. For example, an output could have spreading of [RTR] to consonants, but not vowels. Such patterns are not attested (when the trigger is any segment). I will now show that the constraints used so far actually exclude such an unattested pattern, independent of their ranking.

In (54) we see an input with one consonant, one high and one non-high vowel. I consider only those eight candidates that are produced exclusively by adding association lines to [RTR]. Candidate (a) displays no spreading, candidates (a–d) have one additional association line, candidates (e–g) have two, while candidate (h) has spreading to all segments. The violation marks of alignment constraints in tableau (54) are simplified, such that only segments that participate in violating triplets are marked (the other two categories—PWD and [RTR]—are identical for all candidates and all alignment constraints). From now on, I will use such notation, unless otherwise necessary. Candidates that are harmonically bounded are marked with a left-pointing hand (\leftarrow).⁴ What we see in (54) is that four candidates are harmonically bounded and cannot surface under any ranking.

⁴Here, I use harmonic bounding in the sense of Samek-Ludovici & Prince (1999, 2002): “In its most general form, the harmonic bounding of a candidate is a collective effect: under every ranking some member of the bounding set is guaranteed to beat the bounded candidate, but different members may be responsible for defeating it under different rankings.”

Candidates (c, d) are bounded by (b), candidates (f, g) are bounded by (e). It turns out that these bounded candidates are unattested. No language spreads [RTR] to consonants but not all vowels (c, f, g), or to high vowels but not also to non-high vowels (d). The remaining four candidates are attested, and surface under one ranking or the other.

(54) Factorial typology for RTR spreading

	$\begin{array}{c} [\text{rtr}] \\ \\ / \times \text{ e k i} / \end{array}$	$*\omega[\text{RTR,open}]$	$*\omega[\text{RTR,V}]$	$*\omega[\text{RTR,}\times]$	DEPLINK[RTR]
a.	$\begin{array}{c} [\text{rtr}] \\ \\ \times \text{ e k i} \end{array}$	e	e i	e k i	
b.	$\begin{array}{c} [\text{rtr}] \\ / \quad \backslash \\ \times \quad \varepsilon \text{ k i} \end{array}$		i	k i	*
c. \rightarrow	$\begin{array}{c} [\text{rtr}] \\ / \quad \backslash \\ \times \quad \text{e K i} \end{array}$	e	e i	e i	*
d. \rightarrow	$\begin{array}{c} [\text{rtr}] \\ / \quad \backslash \\ \times \quad \text{e k I} \end{array}$	e	e	e k	*
e.	$\begin{array}{c} [\text{rtr}] \\ / \quad \backslash \\ \times \quad \varepsilon \text{ k I} \end{array}$			k	**
f. \rightarrow	$\begin{array}{c} [\text{rtr}] \\ / \quad \backslash \\ \times \quad \varepsilon \text{ K i} \end{array}$		i	i	**
g. \rightarrow	$\begin{array}{c} [\text{rtr}] \\ / \quad \backslash \\ \times \quad \text{e K I} \end{array}$	e	e	e	**
h.	$\begin{array}{c} [\text{rtr}] \\ / \quad \backslash \\ \times \quad \varepsilon \text{ K I} \end{array}$				***

One obvious way to negate the typology is to include other constraints. One such constraint would be $*\omega[\text{RTR,consonant}]$. As argued above, such a constraint is not in Con. An even more obvious constraints are feature co-occurrence constraints. In section 6.4.3, I show that feature co-occurrence constraints do not modify the predictions based on the interaction of alignment and faithfulness constraints. To give a short preview: I will argue for a fundamental modification of the representation of transparent segments, such that they are also associated with the spreading feature. This means that feature co-occurrence constraints are violated equally by transparent segments and targets. Hence, feature co-occurrence constraints do not prefer transparent segments over targets.

We can conclude that alignment constraints cannot generate unattested patterns, regardless of how they are ranked with respect to each other or the faithfulness constraint $\text{DEPLINK}[F]$. Individual alignment constraints are both typologically and phonetically grounded. Thus, if there is a language that has spreading contrary to the predicted pattern described in this section, it must be due to some other reason.

3.3 Assimilation and dissimilation

In this section, I investigate yet another prediction of the approach based on alignment constraints. In particular, I focus on the interaction of alignment constraints with other constraints. As we have seen in section 3.2, feature spreading occurs when an alignment constraint outranks the corresponding faithfulness constraint against adding association lines. When the ranking is reversed, the feature may (under certain conditions) delink. Thus, alignment constraints can account for feature spreading (assimilation) as well as feature deletion (dissimilation). I will demonstrate the empirical and theoretical differences between these two phenomena using place features.

In section 3.3.1, I describe cross-linguistically attested patterns of place feature spreading. I extend the analysis of RTR spreading established in sections 3.2 and 3.2.4 to (consonant) place features. This means that the cross-linguistic generalizations follow straightforwardly from the typology of alignment constraints pertaining to place features. Under no ranking can these constraints produce unattested patterns. In section 3.3.2, I move on to dissimilation. I contrast dissimilatory and assimilatory patterns regarding place features. I show that both patterns are similar in many ways and that can be accounted for by alignment constraints. However, I also point out that differences between the two processes also follow from the typology of alignment constraints.

3.3.1 Place assimilation

Primary place features of consonants—such as [labial], [coronal] and [dorsal]—display two curious properties. First, they frequently spread to a strictly adjacent target, regardless of what its feature content is. Sometimes a feature spreads from one consonant to an adjacent consonant, while other times a consonant feature spreads to an adjacent vowel (or the reverse). Second, consonant place features do not spread across a vowel. This contrasts with vowel place features—such as [round], [high] and [back]—which frequently spread across consonants. These two puzzling facts have been used to argue that consonant place features are different from vowel place features. In this section, I argue that this difference

is misleading. This is because both types of features have alignment constraints with similar targeted structures. More specifically, both consonant and vowel place features have root nodes and vowels as targeted structures, but not consonants. This account is a simple extension of the proposed typology of feature alignment constraints.

Place features

Place features often spread only to adjacent segments. We have already seen one such example. In Diola-Fogny—(8), also repeated below in (55)—place of articulation of a nasal is determined by the following obstruent.

- (55) Nasal place assimilation in Diola-Fogny (Sapir 1965:16)
- | | |
|----------------------|-----------------------|
| ku-b <u>ɔ̃</u> m-bən | ‘they sent’ |
| na-ti: <u>n</u> -tiŋ | ‘he cut (it) through’ |
| ni-gaŋ <u>ɲ</u> -gam | ‘I judge’ |

Two further observations can be made concerning the Diola-Fogny data. First, the spreading features span across the syllable boundary. This indicates that this particular case of place assimilation cannot be analyzed in terms of alignment within a syllable unless we assume that the nasals are also part of the following syllable. Second, vowels remain unaffected and place does not spread across a vowel. (Blocking is further analyzed in chapter 6.) The remaining question is what would happen if multiple nasals were in the position before an obstruent. Would just one nasal change its place, or would the entire cluster be affected? The Diola-Fogny data do not offer a conclusive answer to this question, because the language does not allow such complex clusters. To the best of my knowledge, no language provides an unambiguous answer to this question.

What the Diola-Fogny data do demonstrate conclusively is that features responsible for consonants’ primary place of articulation do spread from one consonant to another. However, these features can also spread to a vowel. An example of this kind is found in Serbian in (56). In (56-a) we see that a suffix [ɔ̃] alternates with [ɛ], if it is preceded by a coronal consonant.⁵ Non-coronals do not trigger the alternation.

⁵As pointed out by Morén (2006b), the alternation is only triggered by some coronals and only by some morphemes containing these coronals. These issues are not central to the current discussion, which intends to provide examples in which a consonant’s place can spread to a vowel.

(56) Serbian place assimilations (Morén 2006b:1202–1203, Monika Bašić, p.c.)

a. C-to-V: Vowel fronting			
dr̩v- <u>ɔ</u>	‘tree.NOM.SG’	pɔɫ- <u>ɛ</u>	‘field.NOM.SG’
mra:k- <u>ɔ</u> m	‘darkness.INST.SG’	mu:ʒ- <u>ɛ</u> m	‘husband.INST.SG’
lɛ:p- <u>ɔ</u> m	‘beautiful.DAT.SG’	lɔʃ- <u>ɛ</u> m	‘bad.DAT.SG’
lɛ:p- <u>ɔ</u> g	‘beautiful.GEN.SG’	lɔʃ- <u>ɛ</u> g	‘bad.GEN.SG’
b. V-to-C: Palatalization			
vɔj <u>n</u> i:k	‘soldier.NOM.SG’	vɔj <u>n</u> i:tʃ-e	‘soldier.VOC.SG’
sirɔ <u>m</u> a:x	‘poor.NOM.SG’	sirɔ <u>m</u> a:ʃ-e	‘poor.VOC.SG’
ru <u>k</u> -a	‘hand’	ru <u>t</u> ʃ-its-a	‘small hand’
mu <u>k</u> -a	‘pain’	mu <u>t</u> ʃ-it-i	‘to torture’
su: <u>x</u>	‘dry’	su: <u>ʃ</u> -it-i	‘to dry’

What we also find in Serbian is that vowels similarly affect consonants. In (56-b) front vowels {i, ɛ} cause an alternation in which a dorsal obstruent alternates with a coronal obstruent. We have now seen two alternations within a single language. Vowels become front when preceded by a coronal consonant, while dorsal consonants become coronals when followed by a front vowel. These parallels between vowels and consonants are telling. On the one hand, we see that the consonant place features can affect vowels. For example, front vowels cause dorsal consonants to become coronal, which means that consonants become articulated in the front part of the oral cavity rather than at the back. This suggests that a consonant place feature may spread to an adjacent vowel (or the reverse). On the other hand, we know that vowel place features easily skip consonants, such as in a typical vowel harmony. For example, in Finnish (7) front root vowels are followed by front suffix vowels, while consonants remain unaffected. These facts have played an important role in the theory of representations (Clements 1985b, 1991; Steriade 1987a, 1995; Sagey 1990; Lahiri & Evers 1991; Odden 1991, 1994; Jacobs & van de Weijer 1992; Clements & Hume 1995; Halle 1995; Ní Chiosáin & Padgett 1997; Halle et al. 2000; Morén 1999/2001, 2003, 2006b, to name a few). While the representational issues may indeed offer a viable solution, I will discuss the part that is relevant to assimilation as alignment driven feature spreading. In particular, I will account for the fact that consonant place features never spread across vowels. This is an important gap in the data and needs to be accounted for.

To sum up, features responsible for primary place of consonants may spread to other consonants and to vowels. These features can also spread from vowels to consonants. The latter indicates that vowels by themselves must also contain consonant place features. However, vowels also contain a separate set of vowel place features which can spread from a vowel to another vowel across consonants. Furthermore, vowel place features may also spread to consonants themselves.

We do know of languages in which vowels affect secondary place of articulation of consonants. One such example has been provided for other languages in (11). Recall that in Czech, front vowels palatalize the preceding consonant. In Irish palatalization spreads from one consonant to another. A similar pattern that affects multiple targets can be found in Khinalugh. Vowels in Khinalugh roots are always either back or front. In (57) we see that when root vowels are front, root consonants are always palatalized (with some predictable exceptions, see Dressler 1977:55–56 and Dressler 1985:220).

(57) Khinalugh palatalization (Dressler 1977:55)

DAT	NOM	
kʲilʲ-u	kʲilʲ-i	‘friend’
dʒigʲ-u	dʒigʲ-æ	‘place’
	dʲædʲ-æ	‘mother’

The patterns in Czech, Irish (11) and Khinalugh (57) suggest that the same feature is involved in front/back harmony and secondary palatalization of consonants. Similar claims can be made for rounding and labialization. The analysis of spreading in this thesis does not hinge on what place features are allowed to co-occur with others. Instead, alignment constraints allow to distinguish possible combinations of targets. That is, some targets imply other targets, which depends on the targeted structure of alignment constraints.

What we have seen so far is that all types of place features are possible on both consonants and vowels. This is irrespective of whether the place features are traditionally called “consonant” features—like [coronal], [labial], [dorsal]—or “vowel” features—like [round], [high], [low]. In the version of feature theory advanced in this thesis, none of these features are necessarily restricted to a particular set of segments. Assimilation facts do not rely on feature co-occurrence restrictions, but instead on the targeted structure of the alignment constraint.

In short, place features may occur on any segment (be it a vowel or a consonant) and they can spread from any segment to another segment. What does not happen is that a place feature spreads from one consonant to another across an intervening vowel. For instance, there is no language which would map an input /pata/ to the output *[papa], spreading labiality of a consonant across a vowel. This is a widely reported gap (Shaw 1991; Gafos 1996/1999; Hansson 2001; Rose & Walker 2004), which is nevertheless found in child speech and speech disorders (Hansson 2001 and references therein).

The second gap concerns vowel place features. As we have seen above, these can spread to and from vowels or consonants. However, what is not found is that a vowel place feature spreads from a consonant to a vowel across another vowel of the same kind. Furthermore, no vowel place feature spreads from a vowel to

a consonant across another vowel. We can conclude that place features prefer spreading to vowels. If a feature can skip a vowel, it will also skip a consonant, but not the reverse.

The locality typology of place features is summarized in (58). Spreading is graphically represented with an arrow from a trigger to a target. While the representations are regressive, directionality is not relevant here; both progressive and regressive spreading are considered. The first four patterns (Group I) show no transparent segments. As seen above, place features can spread from a consonant to an adjacent vowel, or vice versa. Place features often spread from one consonant to another, as in Catalan (16) or Diola-Fogny (55). Furthermore, some cases of vowel harmony apply only to strictly adjacent segments. An example of this pattern comes from Turkish lowering harmony. Unlike rounding and backness harmony which apply within a word, lowering harmony applies only to strictly adjacent vowels, i.e. in hiatus contexts (Kabak 2007). The cases of local vowel harmony complete the typology of spreading without transparent segments. All possible combinations are attested.

(58) Locality restrictions in assimilation (directionality irrelevant)

	Type	Target	Target/Transp	Trigger	Example processes (language)	
No transparent segments	Ia	V	↙	V	Some cases of vowel harmony (Turkish)	
	Ib	C	↘	C	Place assimilation (Catalan, Diola-Fogny)	
	Ic	C	↘	V	Palatalization (Czech, Serbo-Croatian)	
	Id	V	↘	C	Vowel fronting (Serbo-Croatian)	
Transparent segments allowed	IIab	V	↘	X	V	Vowel harmony (Twi, Wolof)
	IIcd	C	↘	X	C	<i>Restricted</i> (see section 8.5)
	IIe	C _i	↘	C _j	V	Some cases of nasal harmony (Mòbà)
	IIf	V	↘	C	C	Emphasis spread (NPalestinian), vowel flattening (Chilcotin)
	IIg	C	↘	V	V	<i>Unattested</i>
	IIh	V _i	↘	V _j	C	Faucal harmony (Snychitsu?umshtsn)

The second group in (58) involves transparent segments. The number of combinations is doubled because the transparent segment can be a vowel or a consonant. In the first four types, both vowels and consonants can be transparent. Vowel harmony (IIab) often skips consonants and even vowels. Consonant harmony (IIcd) has a similar set of facts. The crucial difference is that the features involved in consonant harmony are restricted. They are never consonant place features and they never target all consonants. Consonant harmony is analyzed in section 8.5. The remaining four patterns are rarely found with most place features. However, the current account unifies place features with other features, since the locality facts are often similar. If we include these patterns, we see that a feature can spread from a vowel to a non-adjacent consonant across a different consonant (IIe), as found in some cases of nasal harmony. Conversely, a feature can spread from a consonant to a vowel across a different consonant (IIf), as found in Northern Palestinian Arabic (Davis 1995) or Chilcotin (Cook 1976, 1983, 1987, 1993).

The remaining two patterns require a longer comment. Pattern IIg involves feature spreading from a vowel to a consonant across a vowel. Such patterns are unattested, and this gap is directly relevant to the current analysis. The gap suggests that vowels make better targets for place features than consonants. Pattern IIh, on the other hand, involves feature spreading from a consonant to a vowel across another vowel. This pattern is attested, even though it is infrequent. Such skipping of vowels is surprising because spreading generally prefers closer targets to distant targets. However, the crucial factor in this case is that the two vowels must be different. For instance, faucal harmony in Sñchitsuʔumshtsn (Bessell 1998) involves RTR spreading triggered by a consonant. Only non-high vowels are targeted, and high vowels and most consonants are transparent. Such a pattern is predicted by the alignment constraint that targets only non-high vowels, as we have seen in Wolof (section 3.2.3). We can conclude that patterns which skip some vowels, but target others do not negate the generalization that vowels make better targets than consonants.

There is a vast body of phonological literature on how to account for the locality gaps in (58). The Cross-Over Constraint (Howard 1972) and The Relevancy Condition (Jensen 1974) are two early rule-based approaches. Later approaches are representational and directly relevant to Autosegmental Phonology (Clements 1985b, 1991; Lahiri & Evers 1991; Sagey 1990; Jacobs & van de Weijer 1992; Odden 1991, 1994; Clements & Hume 1995; Morén 1999/2001, 2003, 2006b). The basic idea of feature geometry can be illustrated with an example in which consonant place features cannot spread from one consonant to another across a vowel. In (59), we see a rather standard approach, according to which vowel place features are dependent on consonant place features. As shown in (59-a), spreading a C-place feature from one consonant to another across a vowel entails skipping a V-place

node which is immediately superior to a place feature. A spreading rule cannot skip nodes. In particular, [labial] can only spread to the adjacent place node (either C-place or V-place). In (59-b), on the other hand, the spreading rule does not skip a node between V-place and [labial] and effectively no association lines are crossed (as represented graphically by convention).

(59) Restrictions of feature geometry

a. Spreading across vowels impossible

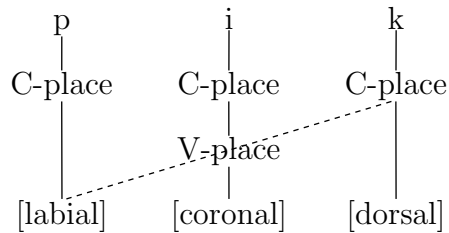

b. Spreading across consonants possible

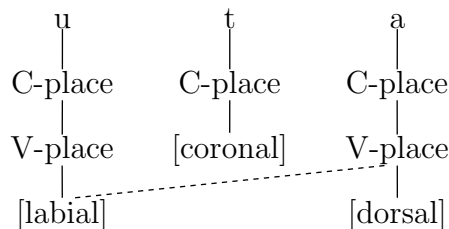

The above representational solution is one way of accounting for gaps in how features spread. Note that representations in feature geometry need to be complemented by operational devices, such as rules or constraints. These mechanisms cannot overrule the restrictions of feature geometry, yet they are required to capture the cross-linguistic variation in assimilation.

The current proposal also relies on constraints. What is not required is a particular segment-internal organization of features that is ingrained in feature geometry. In other words, the only representational distinction is whether a particular root node is associated with a feature or not. The rest is done by constraints. Hence, the current model is less complex or more parsimonious than the earlier proposals.

I have already argued that constraint interaction can account for spreading involving other features (such as RTR in section 3.2). In the following section, I simply extend the same approach to other place features.

Factorial typology

Recall the constraint typology for the feature [RTR] developed in section 3.2. The attested languages show that [RTR] spreads either to all segments, to vowels only, or only to non-high vowels. This can be partly supported by a phonetic connection

of [RTR] with other features. In particular, [RTR] is more compatible with vowels than consonants, and among vowels, [RTR] is more compatible with non-high vowels. One way of representing these hierarchies is by markedness constraints. The present analysis chooses alignment constraints as such markedness constraints. The fact that [RTR] targets vowels rather than consonants, and non-high vowels rather than high vowels suggests that there are three alignment constraints. The first constraint targets all segments (e.g. $*\omega[\text{RTR}, \times]$), the second only vowels ($*\omega[\text{RTR}, \text{vowel}]$), and the third only non-high vowels ($*\omega[\text{RTR}, \text{open}]$). The feature [RTR] represents is essentially a place feature, so it makes sense to use the same approach with other place features. In (58), we have seen that the locality facts for [RTR] spreading are similar to what other place features show. Thus, it is not hard to imagine that constraints referring to [RTR] resemble other place features, including features responsible for consonant place. Place features such as [labial], [coronal] and [dorsal] in the current approach each come with their own set of alignment constraints. This is because we know of languages that only spread a subset of place features, or spread them differently. Here I will only give ranking for one place feature—[labial]. Similar constraints can be posited for the other features. The feature [labial] then involves at least two constraints, which are parallel to the constraints used in connection with [RTR]. The first constraint targets all segments (e.g. $*\omega[\text{labial}, \times]$), while the second targets only vowels ($*\omega[\text{labial}, \text{V}]$). These are defined in (60).

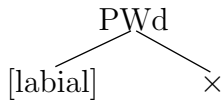
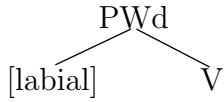
- (60) Spreading of [labial]
- a. $*\text{PWd}[\text{labial}, \times]$
 $*\langle \text{PWd}, [\text{labial}], \times \rangle$ /
- 
- b. $*\text{PWd}[\text{labial}, \text{V}]$
 $*\langle \text{PWd}, [\text{labial}], \text{V} \rangle$ /
- 

In other words, [labial] is similar to [RTR] regarding the distinction between vowels and consonants. Both features prefer to target vowels. In this sense the designation “consonant place features” is somewhat misleading, even though these features can surface independently of any vowel place features only on consonants.

The two constraints in (60) are in a stringency relation. Regardless of their ranking, they cannot produce outputs in which [labial] spreads to consonants to the exclusion of vowels. This is shown in tableau (61), which shows five candidates. Candidate (a) has no spreading, candidate (b) has spreading to the consonant across a vowel, candidate (c) has vowel harmony triggered by a consonant, while candidate (d) shows total spreading. Candidate (b) is harmonically bounded by the

other three candidates. Vowel quality of candidates (c) and (d) involves changes of other features. As pointed out by Baković (2000), this is due to low ranked markedness constraints. He calls the phenomenon in which spreading of one feature triggers subsequent featural adjustments “re-pairing”.

(61) Factorial typology for labial spreading

	[lab] / p a t a /	* ω [lab,V]	* ω [lab,×]	DEPLINK[lab]
a.	[lab] p a t a	a a	a t a	
b. 	[lab] p a p a	a a	a a	*
c.	[lab] p u t u		t	**
d.	[lab] p u p u			***

The inability of the present approach to generate a candidate with spreading of consonant place features across a vowel is a welcome prediction since these patterns are indeed unattested. It remains to be seen whether languages with total harmony like candidate (61-d) do in fact exist. Certainly, such languages seem much more plausible than the unattested languages with primary place consonant harmony (applying across vowels). This follows from the fact that we already know of languages with vowel and secondary place harmony like Khinalugh in (57), while there is no language with secondary place harmony spreading from any segment (consonant or vowel) only to consonants, while the intervening vowels are skipped. Palatalization in Karaim (11-c) is not such a pattern, because it involves assimilation within consonants. In chapter 8, I show that similar patterns are a special case of assimilation and can be attributed to a separate markedness constraint that requires identity between a trigger and a target.

I have demonstrated that alignment constraint typologies can be easily extended to account for essentially any spreading feature, while maintaining the ability to exclude unattested patterns. Alignment constraints are thus a powerful tool in understanding feature spreading. They can account for the typology of targets in any assimilation process.

In the following section, I will look at dissimilation. The empirical facts about dissimilation differ significantly from assimilation. Perhaps unexpectedly, alignment constraints also predict these seemingly conflicting patterns.

3.3.2 Place dissimilation

In this section, I compare assimilation patterns with dissimilation patterns. Both exhibit common properties, including the notion of trigger and target. However, they also empirically and formally differ. I argue that the present approach based on alignment constraints unifies both processes, and the distinction between the two relies on the ranking of faithfulness constraints. Such a unification makes the current approach more parsimonious than the alternatives that deal specifically with dissimilation.

Assimilation vs. dissimilation

Assimilation is remarkably similar to dissimilation. Both are alternations in which a target segment alternates in the presence of a trigger (segment or feature). This rather simple generalization turns out to be more telling. We have already seen that targets in assimilation form a natural class, and that some processes affect more segments than others. Dissimilation has a similar property (Yip 1989; Padgett 1991/1995; Suzuki 1998; Pierrehumbert 1993).

However, there are also two crucial differences between the two phenomena. The first is definitional: assimilation results in two sounds becoming more similar in terms of their feature content, while dissimilation results in two sounds becoming less similar. To put it more formally, an output of a target in assimilation is more phonologically similar to the trigger than the input. Conversely, an *input* of a target in dissimilation is more phonologically similar to the trigger than the output. The formal difference between the two crucially relies on the notion of features. In assimilation, the output of the target is associated with the same feature as the trigger, while in dissimilation the input is. Accordingly, if assimilation is analyzed as feature spreading, dissimilation is to be analyzed as feature delinking, which is shown in (62). This type of operation is referred to as the Obligatory Contour Principle—OCP—in the literature (Leben 1973; Goldsmith 1976; McCarthy 1986; Odden 1988; Yip 1988; Itô, Mester & Padgett 1995; Odden 1994; Myers 1997). In the traditional sense of the word, only the representation in (62-a) falls under the OCP. However, given Richness of the Base we need to assume that inputs with branching association lines are also possible and should also delink, as in (62-b). Whatever the account of dissimilation, it should take care of both configurations.

(62) Dissimilation as feature delinking (OCP)

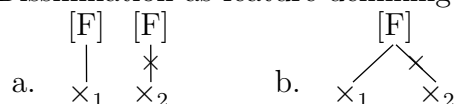

The second difference between the two processes concerns the position of the trigger and the target. If assimilation applies to a target T at some distance from the

trigger t , it will also apply to all intermediate targets (between T and t), as long as there is no difference among the targets. In other words, spreading to a target farthest from the trigger in most cases implies spreading to all intermediate targets. This is also why features like [labial] cannot spread from one consonant to another by skipping vowels. Dissimilation, on the other hand, has no such restriction. It may apply both strictly adjacently (this is ‘dissimilation’ in the traditional sense) or non-adjacently within a domain (long-distance dissimilation). In particular, features like [labial] can dissimilate across a vowel. This fact warrants further investigation.

In what follows, I will show that both assimilation and dissimilation can be accounted for by a single class of markedness constraints. The advantage of such an approach is that it shows that both phenomena are related, in fact they are the opposite sites of the same coin. I am not alone to reach such a conclusion. For example, Ohala (1981) argues that dissimilation is a result of speaker–listener interaction. The idea can be summarized as follows. When a listener hears two similar sounds, they assume to be hearing some sort of assimilation. The listener then removes the similarity between the sounds, which results in a form with dissimilation. Such a grounded approach can constitute a basis for a phonological account, based on a single constraint. The central markedness constraints proposed in this thesis are alignment constraints. The difference between assimilation and dissimilation relates to the ranking of faithfulness constraints.

Tashlhiyt Berber

Tashlhiyt Berber (henceforth, Tashlhiyt) has a dissimilatory pattern in which no more than one labial consonant is possible per word (El Medlaoui 1995; Odden 1994; Alderete 1997). In (63) we see that a prefix containing a labial nasal surfaces as coronal when followed by labial (or labio-dental) consonant within the root. Note that the targeted nasal is affected regardless if it is adjacent to the labial trigger (as in [an-bur] ‘remain celibate.AGENT’) or not (as in [n-kaddab] ‘consider a liar.REFL’). Such a dissimilatory pattern is crucially different from anything possible in assimilation, where a non-adjacent alternation implies a strictly adjacent alternation.⁶

⁶Capitals mark emphatic consonants.

- (63) Labial dissimilation in Tashlhiyt Berber (El Medlaoui 1995:46–47; Odden 1994:319; Alderete 1997:27)
- | | | | |
|------------------|-----------------|------------------|-------------------------|
| <u>m</u> -xazar | ‘scowl.REFL’ | <u>n</u> -fara | ‘disintengle.REFL’ |
| <u>m</u> -saggal | ‘look for.RELF’ | <u>n</u> -ħaffam | ‘be shy.RELF’ |
| <u>mm</u> -zla | ‘lose.REFL’ | <u>n</u> -kaddab | ‘consider a liar.REFL’ |
| <u>am</u> -las | ‘shear.AGENT’ | <u>an</u> -bur | ‘remain celibate.AGENT’ |
| <u>am</u> -krz | ‘plow.AGENT’ | <u>an</u> -AZUM | ‘fast.AGENT’ |

Recall that feature spreading surfaces when an alignment constraint outranks the faithfulness constraint against adding associations, DEPLINK[F]. Of course, there are other constraints that interact with these two constraints. For example, the constraint against deleting input associations, MAXLINK[F] (64) must outrank the alignment constraint. This constraint is parallel to DEPLINK[F] and is thus a simple extension of correspondence theory (McCarthy & Prince 1995) specific to associations (Itô, Mester & Padgett 1995; Lombardi 1998; Myers 1997; Morén 1999/2001; Archangeli & Pulleyblank 2002; Blaho 2008). The constraint MAXLINK[F] preserves an input association and results in feature spreading rather than deletion (which vacuously satisfies alignment).

- (64) MAXLINK[F]
 Let \times_i be an input root node and \times_o its output correspondent. Assign a violation mark, iff \times_i is associated with the feature [F] and \times_o is not.

In dissimilation, the ranking between the two constraints is reversed: alignment outranks MAXLINK[F]. Simply put, it is more important to satisfy the alignment constraint than to preserve an association line. However, complete spreading is not possible when there is more than one instance of a feature in a word. The only option is to delete one of the features. This way the deleted feature does not violate the alignment constraint.

Tashlhiyt shows delinking of [labial] in the prefix, but not in the root. Given these facts, the relevant alignment constraint penalizes triplets $\langle \text{PWd}, [\text{labial}], \times \rangle$ in which [labial] f-precedes the root node, and both [labial] and the root node are within the same Prosodic Word. This constraint, $*\omega[\text{labial}, \times]$, is identical to the one used for assimilation; it is defined in (60-a). Of course, the other alignment constraint that refers to vowels— $*\omega[\text{labial}, \text{V}]$ (60-b)—may also be active. The two alignment constraints outrank MAXLINK[labial].

The effect of the ranking is shown in (65), which contains five outputs. Candidate (a) is faithful. Candidate (b) has feature coalescence (fusion), but no spreading. Candidate (c) has deletion of one instance of [labial] and spreading to the underlying labial. Candidate (d) has coalescence and total spreading. The final and winning candidate (e) has dissimilation. Crucial for the ranking, MAXLINK[labial] must be outranked by the two alignment constraints and some other faithfulness

constraint. Here, $\text{DEPLK}[\text{labial}]$ is used, but a faithfulness constraints against feature coalescence, $\text{INTEGRITY}[\text{labial}]$ (McCarthy & Prince 1995, 1999) would also suffice.

(65) n-kaddab ‘consider a liar’

	$[\text{lab}]_1$ / m - k a dd a b /	$[\text{lab}]_2$	$*\omega[\text{lab}, \times]$	$*\omega[\text{lab}, \text{V}]$	$\text{DEPLK}[\text{lab}]$	$\text{MAXLK}[\text{lab}]$
a.	$[\text{lab}]_1$ m	$[\text{lab}]_2$ b	k(!) a dd a b	a(!) a		
b.	$[\text{lab}]_{1,2}$ m k a dd a	b	k(!) a dd a	a(!) a		
c.	$[\text{lab}]_2$ m k a dd a	b	k(!) a dd a	a(!) a	*(!)	*
d.	$[\text{lab}]_{1,2}$ m p u bb u	b			*!***	
e. 	$[\text{lab}]_2$ n k a dd a	b				*

Before I conclude the analysis of Tashlhiyt, I want to remark on an outstanding issue. Note that the position within a domain determines which instance of $[\text{labial}]$ is preserved and which is dissimilated. Here, I simplified this by claiming it is simply the rightmost segment. This may in fact be true for some languages, in which the leftmost/rightmost segment within a domain is preserved. One way to capture this is by invoking positional faithfulness (Beckman 1997, 1998). Positional faithfulness derives from the concept that some positions are more prominent than others. As regards Tashlhiyt, the rightmost labial within a word is the most prominent. In section 9.4, I argue that such prominence is required for many other cases of assimilation as well as for dissimilation. I continue the Tashlhiyt analysis in section 9.4.3.

Alternatives

Another way of capturing dissimilation is by invoking specific constraints. These constraints deal exclusively with dissimilation and cannot account for other types of alternations. The most common such constraint family is OCP (Myers 1997; Suzuki 1998; Fukazawa 1999). In (66) we see a generic template of OCP constraints as proposed by Suzuki (1998).

- (66) Generalized OCP (Suzuki 1998:42)
 ***X**...**X**: A sequence of two X's is prohibited.

Where:

X ∈ {PCat, GCat}

“...” is intervening interval.

OCP constraints prohibit segments containing some feature, and specify the maximum distance between them. In addition, they need reference to a domain. Crucially, these constraints cannot be used to explain assimilation, including vowel and consonant harmonies. They are designed to deal with dissimilation. I now show their effect on Tashlhiyt data.

Recall that a prefix labial consonant dissimilates when followed by a root labial consonant. The relevant OCP constraint in (67) must therefore refer to [labial] at any distance within a Prosodic Word.

- (67) (*[labial]_∞[labial])_ω
 A sequence of two [labial] segments is prohibited within a Prosodic Word.

The effect of this constraint is shown in (68). The faithful candidate (a) violates a high ranked (*[labial]_∞[labial])_ω constraint. The dissimilated candidate (b) only violates a low ranked faithfulness constraint.⁷

- (68) n-kaddab ‘consider a liar’

/m-kaddab/	(*[labial] _∞ [labial]) _ω	FAITH
a. m-kaddab	*!	
b.  n-kaddab		*

As we have seen, OCP constraints provide a straightforward account of dissimilation. In this sense OCP constraints do not make significantly different predictions than alignment constraints. However, OCP constraints on their own cannot model assimilation. This is because they are equally satisfied by spreading or no spreading, and faithfulness prefers the latter. Hence, OCP constraints are less parsimonious than alignment constraints which can account for both assimilation and dissimilation.⁸

⁷Positional faithfulness is required to distinguish which of the two labials is dissimilated, in which the approach based on OCP constraints is equivalent to the approach based on alignment.

⁸Yet another way of dealing with dissimilation is by invoking Local Conjunction (Smolensky 1993, 1995, 1997) of the same feature within some domain (Alderete 1997; Itô & Mester 2003). If so, only two instances of the feature within a domain will violate the conjoined constraint, but one will not.

In the greater scheme of things, I have demonstrated that alignment constraints provide a unified analysis of assimilation and dissimilation. Furthermore, alignment constraints also predict that assimilation of consonant place features cannot apply across intervening vowels, while dissimilation can. This disparity in locality stems from the formal properties of alignment constraints and the factorial typology. Place features have been used here as example, but the typology is easily extendable to other features.

3.4 Morphological targets

The proposed alignment constraints refer to three categories. So far, I have focused on cases where the targeted structure is a feature or a root node. In this section, I extend the alignment template to morphological domains as the targeted structure, introduced in section 3.1. Such alignment constraints require that a feature is associated with some morphological domain. More specifically, association in this case is only indirect (38): a domain is associated with a feature if at least one of its root nodes is associated with the feature. Such a conclusion is supported by cross-linguistic data. I first examine vowel harmony in Lango which affects only the rightmost root vowel (section 3.4.1). Next, I analyze dissimilation in morphologically complex Dutch loanwords (section 3.4.2). The two cases cannot be accounted for by regular feature spreading/delinking mechanisms and usually require a separate account. This contrasts with the current approach which requires a simple extension to capture the two attested patterns.

3.4.1 Lango

Lango displays a restricted tongue root harmony, which affects only the rightmost root vowel. At first, it appears that alignment constraints do not predict such patterns. An alignment constraint that prefers spreading to vowels cannot terminate spreading after just one target. I propose that the alignment constraints be extended to include morphological targets. Such constraints can have roots as targets and are satisfied by associating a particular feature to a target within the root. I demonstrate the effect of such constraints on Lango. Furthermore, I argue that the alternative analyses are also available, but they cannot capture other feature spreading processes.

Data and analysis

Tongue root alternations in Lango affect only the rightmost root vowels (Okello 1975; Bavin Woock & Noonan 1979; Noonan 1992; Archangeli & Pulleyblank 1994;

Smolensky 2006; Kaplan 2008a,b; Potts et al. 2010). In (69-a), we see that the lax root vowels in unsuffixed forms become tense when followed by a tense suffix vowel. This applies only to the rightmost root vowels. In (69-b), prefix vowels do not alternate depending on the root.⁹

(69) Lango ATR harmony (Noonan 1992:29,32,33)¹⁰

a.	bɔŋɔ	‘cloth’	bɔŋɔ-ni	‘your dress’
	kɔŋɔ	‘beer’	kɔŋɔ-ni	‘your beer’
	atɪn	‘child’	atɪn-wu	‘your child’
b.	bito	‘lure.PERF’	ɛ-bitɔ	‘(that) he lured’
	tuko	‘play.PERF’	ɛ-tuko	‘(that) he played’
	elo	‘open.PERF’	ɛ-elo	‘(that) he opened’

The Lango facts are somewhat puzzling because spreading affects only one vowel. This contrasts sharply with all other cases of feature spreading discussed so far, where all targets within a domain are affected. In Lango, there is no domain boundary between the two root vowels.¹¹ We have already seen that assimilation terminates only for a specific reason, such as reaching a domain edge. In other words, if we compare a candidate with spreading to only one target with another candidate that has spreading to all available targets, only the latter satisfies an alignment constraint. This is true if we use the alignment constraints proposed so far. However, this cannot be the case for Lango, where spreading to one target is sufficient. This means that the constraint responsible for spreading in Lango should either prefer spreading to one target or at the very least not distinguish between spreading to one target or to any number of targets. I will take the second option, and propose a constraint that is equally satisfied by spreading to one or any number of targets within some domain. Faithfulness will prefer spreading to fewest targets.

As we have seen so far, alignment constraints have a wide range of application. They can also model assimilation and dissimilation. In the alignment constraints discussed so far, one of the categories—the targeted structure—is a feature. The template also allows other structures, such as a root node. As we have seen

⁹Here I focus on one aspect of Lango vowel harmony. The full pattern is considerably more complex. In particular, the pattern involves disparities between triggers and targets. Some of these are analyzed in chapter 4. The analysis can be straightforwardly extended to Lango, and this task ultimately remains beyond the scope of this thesis.

¹⁰Tones are omitted.

¹¹The only such domain boundary could be an edge of a foot. However, there are two arguments against such a conclusion. First, the foot in question would always have to consist of a root-final vowel and an adjacent suffix vowel. This seems unlikely, because footing is rarely determined exclusively by morphological boundaries. Second, there is no independent evidence for such footing. This suggests that a foot as the domain of Lango harmony is stipulative.

in section 3.1, prosodic and morphological domains may also serve as targeted structures. For example, a constraint can have a root as the targeted structure.

In order to formalize this situation, we need to state that features may also be associated with morphological or prosodic domains (and vice versa). In classic Autosegmental Phonology, association lines are strictly between different levels of representations, which means that a feature may be associated with a root node or another, dependent feature. In this thesis, I assume no dependency among different features (section 2.2.1), hence the only remaining association is that between a feature and a root node. This is direct association. However, I have been consistently using association in another sense. A feature can be indirectly associated with another feature, if both features are linked to the same root node. A feature is indirectly associated with a domain, if the feature and the domain are linked to the same root node. This second or indirect association is ingrained in the concept of alignment constraints, which require that two features are associated with the same domain. I have made this explicit by calling this latter type of relationship between two features Association by Proxy (38). Association by Proxy also applies to association between a feature and a domain.

Association by Proxy makes two crucial predictions. First, a feature can only be associated to domains containing segments. Second, any constraint that refers to a feature and its association with a domain, makes indirect reference to all root nodes within that domain. This is directly relevant to the alignment constraints, which are subject to the same generalization. If the targeted structure of an alignment constraint is a morphological domain, spreading to at least one root node of that domain will satisfy it. This sounds exactly like the alignment constraint active in Lango. In Lango, [ATR] spreads to a root, within a prosodic word. The prefix is not affected. The relevant constraint in (70) penalizes roots that f-precede [ATR] segments.

(70) *PWd[root, ATR]

a. *(PWd, [ATR], root) / $\begin{array}{c} \text{PWd} \\ \swarrow \quad \searrow \\ \text{root} \quad \text{[ATR]} \end{array}$

b. Assign a violation mark for every triplet $\langle \text{PWd}, [\text{ATR}], \text{root} \rangle$, iff
PWd is associated with [ATR] and with a *root*
 and
 $\text{root} \triangleleft [\text{ATR}]$.

The faithfulness constraint DEPLINK[ATR] prefers a candidate with less added associations, and other alignment constraints prefer spreading to a vowel rather than a consonant. That is, different alignment constraints with [ATR] as the spreading feature are in a stringency relationship, and always prefer spreading to

vowels rather than consonants. These alignment constraints are parallel to the ones proposed for [RTR] and place features.

In tableau (71) we see the effect of *PWd[root, ATR]. Candidate (a) has no spreading and hence does not violate DEPLINK[ATR]. However, this candidate fatally violates the high ranked alignment constraint. All other candidates show spreading to the root and hence satisfy *PWd[root, ATR]. Note that Association by Proxy (38) states that a feature is associated with a domain only if at least one root node of that domain is associated with the feature. This is the case in all candidates but (a). The remaining candidates spread [ATR] to at least one segment within the root. The winning candidate (b) shows spreading to a vowel and incurs one less violation mark of *PWd[V, ATR] compared to candidate (c). Finally, candidate (d) has spreading to both vowels, and loses on DEPLINK[ATR]. In short, spreading to one target is preferred by a high ranked DEPLINK[ATR], whereas the target itself is chosen by the low ranked alignment constraints, which also follows from general principles of alignment constraints discussed in previous sections.¹²

(71) bɔŋoni ‘your dress’

		*ω[root,ATR]	DEPLINK[ATR]	*ω[V,ATR]	*ω[×,ATR]
a.		*!		ɔ ɔ	b ɔ ŋ ɔ n
b.			*	ɔ	b ɔ ŋ n
c.			*	ɔ ɔ!	b ɔ ɔ n
d.			**!		b ŋ n

To summarize, Lango shows apparently non-iterative spreading, which is triggered by the alignment constraint that has the root as the targeted structure. A low ranked faithfulness constraint limits spreading to one target, the choice of which is determined by other alignment constraints. This suggests that the current approach is a powerful one, since it can be easily extended to account for cases of

¹²Several other candidates are left out. For example, a candidate that shows spreading to the leftmost root vowel while also skipping a vowel, [bɔŋɔni], ties with candidate (b). I will address this candidate in chapter 5. A short preview: I will argue that spreading is strictly local. This principle prefers spreading to the target closest to the trigger in case of multiple equivalent targets.

non-iterative spreading from a suffix to a root. The current approach also gives us a new insight into why such patterns are attested: what matters in these cases is to associate some segment of the root with a suffix feature. Other alignment constraints then choose which segment is targeted.

Alternatives

Alternative analyses of Lango rely on specific constraints. One such approach is that of positional licensing (Steriade 1995; Zoll 1998a,b; Piggott 2000; Walker 2001, 2004, 2005; Kaplan 2008b). The reasoning behind this approach is that prominent positions generally contrast more than non-prominent positions. A feature realized on a prominent position has a different status than one on a non-prominent position. In terms of constraints, positional markedness constraints may require a feature to be associated with a morphologically, prosodically or psycholinguistically prominent position. Roots are more prominent than suffixes (McCarthy & Prince 1995; Beckman 1997, 1998; Alderete 2001; Smith 2005; Urbanczyk 2006), thus features realized on roots fare better on some markedness constraint than features not realized on roots. An informal characterization of such a constraint relevant to Lango is in (72).

- (72) LICENSE[ATR] (adapted to unary features from Kaplan 2008b:75)
 [ATR] must be linked to root segments.

Tableau (73) demonstrates the effect of LICENSE[ATR]. The candidates are equivalent to the ones in tableau (71). Parallel to the alignment constraint *PWd[root, ATR], the licensing constraint LICENSE[ATR] is only violated by the fully faithful candidate (a). Similarly, DEPLINK[ATR] excludes candidate (d) that has two epenthesized associations. The feature co-occurrence constraint *[ATR consonant] penalizes tense consonants, excluding candidate (c). Candidate (b) wins.

(73) bəŋoni ‘your dress’

	[atr] / b ə ŋ ə - n i /	LICENSE[ATR]	DEPLINK[ATR]	*[ATR consonant]
a.	[atr] b ə ŋ ə n i	*!		
b.	[atr] b ə ŋ ə n i ↙		*	
c.	[atr] b ə ŋ ə n i ↘		*	*!
d.	[atr] b ə ŋ ə n i ↙ ↘		**!	

The constraint LICENSE[ATR] does the job of the proposed alignment constraint *PWD[root, ATR]. Specifically, both constraints trigger spreading if there is an instance of [ATR] outside a root. However, the difference is that alignment constraints are needed independently of the patterns discussed in this section. Furthermore, the targeted structure of the alignment constraint can also be a prosodic constituent (e.g. a stressed syllable), which can then do the job of prosodic licensing constraints.¹³ Therefore, Con containing both alignment and licensing constraint families makes the same predictions as Con containing only alignment constraints.

In this section, I analyzed one aspect of Lango vowel harmony. I unified bounded spreading in Lango with unbounded spreading in previous sections. The solution is an extension of alignment constraints, which may also have morphological domains as a targeted structure.

3.4.2 Dutch

The second case in which a feature spreads to a morphological domain is found in Dutch. Dutch resembles Lango in that a feature of one morpheme interacts with another morpheme. In Lango, a feature spreads to a neighboring morpheme. In Dutch, on the other hand, the relevant feature delinks. As we have seen in section 3.3, alignment constraints can model both types of alternations, depending on the ranking of faithfulness constraints. I now extend the same approach to morphological, rather than purely phonological, targets.

¹³Another argument in favor of alignment constraints over positional licensing is in section 4.6.3.

In Dutch loanwords, there is an alternation involving retroflex rhotics as in (74).¹⁴ The retroflex is transcribed as [ɹ], although its precise articulation varies considerably. As we can see from the data below, a root [ɹ] alternates with [ʁ] when the root is followed by a suffix. The surprising fact about Dutch is that this happens regardless of what the suffix is. In other words, a root [ɹ] becomes [ʁ] when followed by any segmental morpheme. This is unlike any of the previously reported cases of assimilation.

(74) Dutch retroflex dissimilation (Eefje Boef, Marleen van de Vate, and Marc van Oostendorp p.c.)

Ba[ɹ]ack	‘Barack’	ba[ʁ]ack-en	*ba[ɹ]ack-en	‘Barack.V’
		Ba[ʁ]ack-se	*Ba[ɹ]ack-se	‘Barack.ADJ’
		Ba[ʁ]ack-je	*Ba[ɹ]ack-je	‘Barack.DIMIN’
[ɹ]oosevelt	‘Roosevelt’	[ʁ]oosevelt-en	*[ɹ]oosevelt-en	‘Roosevelt.V’
		[ʁ]oosevelt-se	*[ɹ]oosevelt-se	‘Roosevelt.ADJ’
		[ʁ]oosevelt-je	*[ɹ]oosevelt-je	‘Roosevelt.DIMIN’
[ɹ]ex	‘Rex’	[ʁ]ex-en	*[ɹ]ex-en	‘Rex.V’
Op[ɹ]ah	‘Oprah’	op[ʁ]ah-en	*op[ɹ]ah-en	‘Oprah.V’
		Op[ʁ]ah-tje	*Op[ɹ]ah-tje	‘Oprah.DIMIN’
Flo[ɹ]ida	‘Florida’	Flo[ʁ]ida-tje	*Flo[ɹ]ida-tje	‘Florida.ADJ’
		Flo[ʁ]ida-sje	*Flo[ɹ]ida-sje	‘Florida.DIMIN’
[ɹ]eading	‘Reading’	[ʁ]eading-kje	*[ɹ]eading-kje	‘Reading.ADJ’
		[ʁ]eading-je	*[ɹ]eading-je	‘Reading.DIMIN’

One way to characterize this puzzling alternation is to say that Dutch loanwords present a case for loanword integration. Unsuffixed loanwords allow retroflex rhotics, which need to be changed to conform to the native phonology in suffixed words. While this is a possible analysis of the Dutch pattern, there are a few other similar cases that do not involve loanwords. For example, in Slovenian schwa is possible in bare native roots, but not when a root is followed by a derivational suffix (Jurgec 2010c). What this suggests is that the loss of exceptionality is relevant in Dutch, but the morphological condition is an additional factor that needs an account of its own.

Another way to approach the Dutch data is to say that the feature found on the retroflex dissimilates in any morphologically complex word. More specifically, what seems to be happening is that the feature pertaining to the retroflex delinks whenever the root is followed by another morpheme. The advantage of this view is that it makes the alternations in Dutch directly comparable to Tashlhiyt dissimilation on the one hand, and to Lango morphological spreading on the other. Dutch is similar to Tashlhiyt because a feature of the retroflex is delinked when followed by a trigger. However, unlike Tashlhiyt, this trigger is not a feature, but a morphological domain—a suffix. Dutch is also similar to Lango, because the

¹⁴To the best of my knowledge, this alternation is first noted in Simonović (2009:fn.30).

alternations in both languages involve morphological domains. Yet Lango spreads a feature to a morphological domain, while Dutch delinks a feature when a morphological domain is present. The parallels among these three languages suggest that they may be analyzed using similar constraints. The differences among the three languages can be attributed to differences in the ranking of these constraints.

Dutch retroflex dissimilation is representative of a larger class of alternations, which are called long-distance or pseudo-Derived Environment Effects (DEEs; Kiparsky 1993; Inkelas 2000; McCarthy 2003b; Wolf 2008; Jurgec 2010c). DEEs are alternations that are found only in suffixed forms (Kiparsky 1973). Most reported cases of DEEs are strictly local and occur only at a morpheme boundary. We have seen an example of this in Serbian (56) where [coronal] spreads from a vowel to an adjacent consonant. Serbian palatalization happens only at the morpheme boundary. Long-distance DEEs, on the other hand, exhibit segmental alternations that occur anywhere in a suffixed word. As we have seen above, Dutch allows retroflex rhotics in bare root forms, but replaces them with non-retroflex rhotics in suffixed words.

To recap, there are two crucial differences between local DEEs as in Serbian and long-distance DEEs as in Dutch. First, only suffixes beginning with front vowels trigger local DEEs, whereas any suffix—regardless of its feature makeup—triggers long-distance DEEs. Second, local DEEs are limited to the position at the morpheme boundary, whereas long-distance DEEs occur anywhere within the root. These two facts appear unconnected. Yet when we consider them in terms of the present approach to assimilation, they begin to make more sense. In section 3.3, I have shown that while assimilation cannot apply across some segments, dissimilation can. This suggests that local DEEs involve assimilation, while long-distance DEEs involve dissimilation. We have further seen that assimilation can target both segmental targets (as in SPalestinian, Twi or Wolof) and morphological targets (as in Lango). The same is true for dissimilation. Tashlhiyt labial dissimilation is conditioned by segmental triggers. That is, a labial becomes coronal when followed by another labial. Dutch retroflex dissimilation, in contrast, is conditioned by morphological triggers. That is, a retroflex becomes non-retroflex when followed by a suffix. The feature content of this suffix does not matter, all that matters is its presence.

The analysis of Dutch retroflex dissimilation is entirely consistent with the present approach based on alignment constraints. If the pattern is analyzed in terms of features, the feature [retroflex] delinks in any form containing a suffix. While Dutch does not exhibit any reliable data in which the triggering morpheme could also be another root, similar patterns are found in other languages that do. Other languages with similar patterns include: French (Kiparsky 1973), Catalan (Mascaró 1978, 2003, to appear), Spanish, Hungarian, Slovenian (Jurgec 2010c),

and arguably English (McCarthy 2003b:144; Wolf 2008:269; Burzio 1994:320ff). In Slovenian, for example, compounds can have a retroflex only in the rightmost root. There is no reason to assume a different analysis for Dutch. Thus, it is actually any morpheme that triggers delinking of [retroflex]. The alignment constraint active in Dutch has [retroflex] as the spreading feature and the morpheme as the targeted structure. The constraint is defined in (75).

- (75) *PWd[retroflex, morpheme]
- a. *⟨PWd, [retroflex], morpheme⟩ /
- ```

 PWd
 / \
 [retroflex] morpheme

```
- b. Assign a violation mark for every triplet ⟨*PPh*, [retroflex], *morpheme*⟩, iff
- PPh* is associated with [retroflex] and with a *morpheme*  
and  
[retroflex] ≺ *morpheme*.

The constraint in (75) appears a bit unusual in terms of traditional view of alignment constraints. This constraint requires [retroflex] to be realized on some following morpheme (either a root or an affix). The alignment constraint template in this thesis predicts that morphological domains can also fill the targeted structure slot, as in (37). Furthermore, we have already seen the effects of one such constraint, \*PWd[root, ATR], in Lango vowel harmony (71). Hence, extending the template to include morphemes as targeted structures does not come as a surprise.

What distinguishes Dutch from Lango, however, is that [retroflex] does not spread to the suffix, but rather delinks, and the default rhotic surfaces as a result. We have already seen that alignment outranks MAXLINK[F] in dissimilation patterns such as in Tashlhiyt (63). The same is true in Dutch. Tableau (76) shows the two possible candidates. Candidate (a) is fully faithful, but fatally violates the alignment constraint. Candidate (b) shows delinking and hence vacuously satisfies alignment, but violates MAXLINK[retroflex].

- (76) [B]oosevelt-je ‘Roosevelt.DIMINUTIVE’

|      | [rx]<br>/ ɪ / o o s e v e l t - j e                             | *ω[rx,morph] | MAXLINK[rx] |
|------|-----------------------------------------------------------------|--------------|-------------|
| a.   | <pre>       [rx]             / ɪ / o o s e v e l t j e   </pre> | *!           |             |
| b. ↵ | ɾ o o s e v e l t j e                                           |              | *!          |

When the retroflex is in the rightmost (or only) morpheme of a prosodic word, alignment is not violated. Tableau (77) reveals that in that case, the retroflex can surface faithfully, as in candidate (a). Candidate (b) with dissimilation fatally violates MAXLINK[rx].

(77) [ɹ]oosevelt ‘Roosevelt’

|                                                                                      |                                    |                       |             |
|--------------------------------------------------------------------------------------|------------------------------------|-----------------------|-------------|
|                                                                                      | [rx]<br> <br>/ ɹ / o o s e v e l t | * $\omega$ [rx,morph] | MAXLINK[rx] |
| a.  | [rx]<br> <br>ɹ o o s e v e l t     |                       |             |
| b.                                                                                   | ɹ o o s e v e l t                  |                       | *!          |

This concludes the analysis of long-distance DEEs in Dutch. As I have shown, the Dutch pattern can be accounted for by a simple extension of alignment constraints, such that the targeted category is the morpheme.

Dutch differs from Lango in two important ways. First, Dutch is a case of dissimilation rather than assimilation. Second, Dutch deretroflexion applies across many consonants and vowels, while in Lango ATR harmony spreads only across consonants. Both patterns can be accounted for by alignment constraints that contain a morphological domain as the targeted structure.

### 3.5 Summary

This chapter looks at more predictions of the alignment constraints introduced in chapter 2. As we have seen, the alignment constraints consist of three categories. The focus of this chapter is one of these categories—the targeted structure. Targets may be features, root nodes or morphological domains.

First, I examine the relationship between the spreading feature and the targeted structure. By restricting all possible combinations of the two categories, it is possible to account for the cross-linguistic gaps in locality of spreading. A particular spreading feature prefers some targets more than others. For example, [RTR] prefers spreading to non-high vowels rather than to high vowels, and to vowels rather than to consonants. The empirical observations can be captured with alignment constraints that have the same spreading feature, but different targeted structures. However, in the model advanced in this thesis, Con contains only a subset of all theoretically possible alignment constraints. For instance, if the spreading feature is [RTR], the targeted structures can be all root nodes, vowels, or non-high vowels, but crucially not consonants or high vowels. These constraints

can under no ranking produce an unattested grammar with spreading of [RTR] to consonants but not to vowels, or to high vowels but not to other vowels.

Next, I extend the findings based on [RTR] to other features. It turns out that all place features behave similarly. They prefer spreading to vowels rather than consonants. This is why place features can spread from a consonant to a vowel across other consonants, but not from a vowel to a consonant across other vowels. A simple extension of alignment constraints to place features can then successfully create a factorial typology, which rules out the unattested patterns.

I further show that alignment constraints can also account for phenomena other than assimilation. Under some rankings, alignment prefers delinking of a feature rather than spreading. This is what indeed happens in dissimilation, where a high ranked faithfulness constraint inhibits spreading, and the alignment constraint prefers delinking. One further observation is that dissimilation is not restricted in the same way as assimilation. In particular, place features cannot assimilate across vowels, but can dissimilate across vowels. This pattern is predicted by the alignment constraints and the relationship between the spreading feature and its targeted structures.

Restricting alignment constraints to a small subset of targeted structures has been shown to give good typological predictions. However, expanding the set of possible targeted structures is also beneficial. In particular, alignment constraints may also include a morphological domain as the targeted structure. When such a constraint is high ranked, spreading to a single target in a neighboring morpheme is preferred. In other words, what matters in these attested patterns is to associate a feature with some segment in another morpheme. Furthermore, the same approach can account for dissimilation, which is triggered by any morpheme within a prosodic domain. Again, a simple modification of the targeted structure is entirely sufficient to account for these attested patterns.

We can conclude that alignment constraints are a powerful tool in dealing with feature spreading. Alignment constraints restrict possible targets to a single natural class, they can generate typologies of targets, they allow a unified analysis of assimilation and dissimilation, and they can deal with morphological conditions on feature spreading.



## Part II

# Assimilation as Hierarchy



# Chapter 4

## Icy targets

Chapters 2 and 3 explored the predictions of alignment constraints. Alignment constraints have three variables: a spreading feature, a targeted structure and a domain. A particular alignment constraint prefers that a spreading feature is associated with targeted structures within a domain. What it cannot do is distinguish between targets within a domain: all segments containing the targeted structure are treated the same.

In this chapter, I present evidence that there are two kinds of targets. Most targets have no effect on subsequent targets. Some targets, however, disallow any further targets within the relevant domain and effectively terminate spreading. In other words, they *freeze* spreading. The *icy target* behavior does not emerge directly from alignment constraints. It needs a separate account.

From the earliest days of Autosegmental Phonology, there were two proposals about how to deal with feature spreading. The first one says that all associations are equivalent and there are no restrictions on branching: a single feature may be directly linked to any number of segments. The second proposal says that feature spreading involves maximally binary branching. Spreading to more than one target creates recursive domains. Each binary domain is headed. This approach is based on metrical theory and the idea behind it is that features are similar to prosodic units and thus involve binary domains. However, no evidence has been found to support this more complex proposal and consequently, the first proposal without heads and binary domains became standard.

Icy targets present the test case between the two approaches. In a classic autosegmental account there is no difference between types of associations. In a metrical approach to feature spreading, however, there are two types of relations between a feature and a root node. Some root nodes are heads (and allow further spreading), while others are not. In the proposal that will be developed below, icy targets can be associated with a feature, but cannot be heads, which means that no further targets can be reached.

This chapter is organized as follows. Section 4.1 introduces an example of an icy target. Section 4.2 presents formal properties of the proposed solution. The three following sections present analyses of three spreading processes involving icy targets: u-umlaut in Icelandic (section 4.3), Nati retroflexion in Sanskrit (section 4.4), and nasal harmony in Ikwere (section 4.5). Section 4.6 gives several alternative accounts, all of which ultimately fail. Section 4.7 concludes this chapter.

## 4.1 Introduction

In this section, I present data that suggest that there are two kinds of targets. The first type has no effect on spreading and allows further propagation of a feature. The second type, on the other hand, terminates the spreading process. A feature can spread to a particular target, which undergoes spreading; at the same time such a target *freezes* the features and terminates spreading to all subsequent targets. I call this special type of segment an *icy* target.

Consider an example. U-umlaut in Icelandic (78) is an alternation in which a suffixal /y/ fronts and rounds the preceding /a/ to [œ], as shown in (78-a).<sup>1</sup> There is a separate vowel reduction process which raises all unstressed (i.e. non-initial) instances of [œ] to [ɤ] (78-b). However, in polysyllables we see that the reduction allows fronting and rounding to apply further leftwards. For example, ‘suit of clothes’ contains two [a]’s in the nominative singular. In the dative plural, suffixal /y/ fronts and rounds a preceding /a/, but because of reduction, the segment is realized as [ɤ] rather than [œ]. The derived [ɤ] is a further trigger, turning the preceding /a/ to [œ]. Some roots do not reduce (78-d); these roots show that [œ] does not allow the features to spread. For instance, the dative plural form of ‘Japanese’ is *j[œ]p[œ]n[ɤ]m*, and not *\*j[œ]p[œ]n[ɤ]m* as we would have expected if [œ] allowed further fronting and rounding.

(78) Icelandic u-umlaut (Anderson 1972, 1974, Orešnik 1975, 1977)

|    |                               |                  |                   |
|----|-------------------------------|------------------|-------------------|
| a. | U-umlaut in monosyllables     |                  |                   |
|    | NOM.SG                        | DAT.PL           |                   |
|    | b[ <u>a</u> ]rn               | 'b[œ]rn[ɤ]m      | ‘child’           |
|    | 'd[ <u>a</u> ]lir             | 'd[œ]l[ɤ]m       | ‘valley’          |
| b. | Vowel reduction               |                  |                   |
|    | 'h[ɛ]r[ <u>a</u> ]ð           | 'h[ɛ]r[ɤ],ð[ɤ]m  | ‘district’        |
|    | '[ɔ]ð[ <u>a</u> ]l            | '[ɔ]ð[ɤ],l[ɤ]m   | ‘allodium’        |
| c. | Polysyllables with reduction  |                  |                   |
|    | 'f[ <u>a</u> ]tn[ <u>a</u> ]ð | 'f[œ]tn[ɤ],ð[ɤ]m | ‘suit of clothes’ |
|    | 'b[ <u>a</u> ]k[ <u>a</u> ]ri | 'b[œ]k[ɤ],r[ɤ]m  | ‘baker’           |

<sup>1</sup>Thanks to John McCarthy for bringing these data to my attention.





Tableau (81) demonstrates that regardless of the ranking between  $*\omega[V, \text{round}]$ ,  $\text{DEPLINK}[\text{round}]$ , and  $*\text{œ}$ , the actually attested candidate cannot surface. Of all three candidates, only the icy target candidate (b) violates all three constraints, which means it is harmonically bounded by the other two candidates. When the alignment constraint  $*\omega[V, \text{round}]$  outranks the other two constraints, candidate (c) with total spreading surfaces. Under all other rankings, the faithful candidate (a) wins. We can conclude that no constraint prefers the icy target candidate.

(81) japœnym ‘Japanese.DAT.PL’

|                  | [rd]<br>/ j a p a n - y m /<br>[op] [op] | $*\omega[V, \text{round}]$ | $\text{DEPLINK}[\text{round}]$ | $*\text{œ}$ |
|------------------|------------------------------------------|----------------------------|--------------------------------|-------------|
| a.               | [rd]<br>j a p a n y m<br>[op] [op]       | $*(!)*$                    |                                |             |
| b. $\rightarrow$ | [rd]<br>j a p œ n y m<br>[op] [op]       | $*(!)$                     | $*(!)$                         | $*(!)$      |
| c.               | [rd]<br>j œ p œ n y m<br>[op] [op]       |                            | $*(!)*$                        | $*(!)*$     |

Icy targets are an attested pattern, which cannot be captured within the current autosegmental approach using alignment constraints. This calls for a modification of the feature spreading mechanism. At first, it seems there are two options that could distinguish the two types of targets. The first one would entail modifying constraints, while the second one would require representational modifications. I argue that neither option is sufficient alone. Instead, representational modifications that introduce new structures must be accompanied by specific constraints that refer to these structures.

## 4.2 Binary Domains Theory

Icy targets present an important piece of evidence that the classic concept of association is deficient. In particular, association cannot distinguish between regular and icy targets. One solution to this challenge would be to posit different types

of associations. However, this alone may be difficult to formalize. What I propose instead is to modify the representation of feature spreading altogether.

This section is organized as follows. Section 4.2.1 highlights the differences between association in Autosegmental Phonology and Metrical Theory. Only the latter concept is consistent with icy targets. Section 4.2.2 formalizes this approach and introduces a novel theory of feature spreading—Binary Domains Theory. The theory incorporates headedness and binarity into the feature spreading mechanism. These well-established concepts are discussed in section 4.2.3. Section 4.2.4 complements the representational elements of the theory with constraints.

### 4.2.1 Association in Metrical Theory

In phonology, association has been used in at least two different ways. One use is that of Autosegmental Phonology where it is used primarily for tone and segmental features. The other use is that of Metrical Theory where it is used for prosodic phenomena (Lieberman & Prince 1977; Hayes 1984b). So far I have used the association of Autosegmental Phonology. I will now focus on the second option. In Metrical Theory, association groups prosodic constituents such as moras and syllables into higher units such as feet. In other words, prosodic units exhibit hierarchical structure. Such a representation is in (82), which shows prosodification of a single English word. Syllables are linked into higher constituents, which consist of a strong (s) and a weak (w) part. These are in turn joined into a higher constituent, consisting of a strong (S) and a weak (W) part. In this example, prosody can be thought of as rhythmic organization, consisting of alternating peaks and troughs. The second and the fourth vowels (*execution*) are less prominent than the first (*execution*), which is in turn less prominent than the third (*execution*). The strong element—a head—is represented by ‘s/S’ as originally proposed by Lieberman & Prince (1977). The weak element—a dependent—is represented by ‘w/W’.

(82) Representations of Metrical Theory (Lieberman & Prince 1977:268)

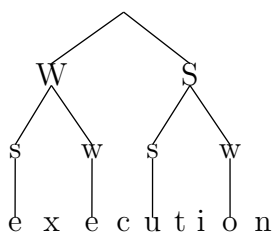

Two observations about (82) are in order. First, all branching is maximally binary. No node has more than two branches. Second, branching is hierarchical, consisting of peaks/heads and troughs/dependents. Such representations capture the general-

ization about rhythmic patterns across human languages. Prosody typically forms binary units in which the two constituents have a different status. Features, on the other hand, rarely exhibit such patterns. In particular, no known case of feature spreading involves a rhythmic skipping of every other target.

Nevertheless, the representations of Metrical Theory have been used to account for feature spreading in some literature (Vergnaud 1979; Zubizarreta 1979, 1982; Halle & Vergnaud 1980, 1981; Steriade 1981; Kaye 1982; Poser 1982; Leben 1982). As pointed out by Leben (1982), the autosegmental and metrical model were considered equally capable of capturing segmental processes in the early days of Autosegmental Phonology. There were no reported segmental or tonal patterns which could distinguish between the two models. However, metrical representations have been ultimately rejected because they are more complex than the alternative. In particular, metrical representations require additional structures (such as heads) and make restrictions on branching, which are not required in the alternative autosegmental representations. I will now demonstrate that icy targets represent a crucial case in which the two models make different predictions with the result that only the metrical model can account for icy targets.

In (83), I show two representations involving a feature [F] that spreads from the leftmost root node  $\times_1$  and targets all other root nodes. The representation in (83-a) makes no distinction among root nodes. All are in an equivalent relationship with respect to the feature [F]. Any of them could be a trigger or a target. In other words, [F] is equally aligned with all root nodes; the fact that it is graphically aligned with the third root node does not bear any significance. The representation in (83-b) also depicts a single feature linked to five root nodes, yet it is markedly different. The feature [F] spreads in a binary fashion. The highest node (marked as [F]) is linked to the rightmost root node  $\times_1$  and to another node, which is in turn linked to  $\times_2$  and another node. The domains are recursive. Note that all but the leftmost root node are heads, which is marked by an 's'. Of the two representations, (83-b) is considerably more complex, but also contains more information. In particular, the trigger is  $\times_1$  rather than any other root node. Consequentially, spreading is rightwards rather than leftwards.

(83) Autosegmental and metrical representations

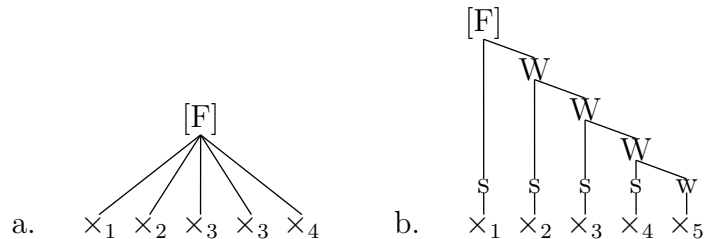

When we compare representations of stress in (82) and spreading in (83-b), we see many similarities. Both contain association lines connecting different elements. Not more than two elements are connected to a higher node, creating (maximally) binary domains. These domains consist of a prominent or head element (s) and a dependent element (w).

Yet there are also significant differences between the two possibilities. The higher nodes (marked by capitals) in (82) connect lower non-recursive nodes. This is also true for the final W-node in (83-b). However, other nodes are linked to nodes that already contain a W themselves. In other words, while nodes in (82) represent higher constituents, representations in (83-b) represent the same type of constituents, and constituents themselves can be recursive. Another difference concerns the lower nodes (marked by lowercase letters). In the representation of stress in (82), they form a sequence of alternating heads (s) and dependents (w). This contrasts with (83-b), where only the final root node is connected to a dependent (w), while all other nodes are heads (s).

These representational differences can be attributed to the fact that prosody also significantly differs from feature spreading. If we look at stress, languages prefer alternating rhythmic peaks and troughs (Hayes 1980, 1984b, 1995; Prince 1983; Selkirk 1984). This can be represented by head–dependent pairs. In contrast, feature spreading does not involve a rhythmic skipping of every other target. All targets are equivalent to the extent that they are all heads. It is only the final target that lacks a head.

Final targets have a special status compared to all other targets. Most targets are both heads and dependents of a feature, whereas the final target is only a dependent. This distinction between the two types of targets relates directly to icy targets. Recall Icelandic u-umlaut described in section 4.1. In Icelandic, some vowels prefer to be final targets. These icy targets attain a feature, but fail to propagate it. The ability to propagate a feature can be couched in terms of headedness. Most segments can be associated with a feature and also be its head. Thus, these segments can propagate the relevant feature. Icy targets, on the other hand, can be associated with a feature, but cannot be heads of a feature. That is why they are targets but concurrently terminate spreading. The distinction between heads and dependents makes sense only within Metrical Theory, but not in classic Autosegmental Phonology. We can conclude that the former model is preferred, since its predictions are a better match for the attested pattern of icy targets. In what follows, I will propose a theory of spreading, which formalizes the intuitions of Metrical Theory and transfers it to feature spreading.

### 4.2.2 Formalism

In the previous section, I examined the differences between two concepts of association: one from classic Autosegmental Phonology and one from Metrical Theory. I claimed that the latter is superior to the former because it can capture icy targets. In this section, I present Binary Domains Theory (BDT), which formalizes autosegmental spreading by extending the concept of association within Metrical Theory to segmental features. In particular, I propose a feature spreading mechanism that restricts spreading to headed binary domains, where spreading to multiple targets creates recursive domains.

In rule-based Autosegmental Phonology, feature spreading is a simple two step operation: (i) associate a feature with the closest target and (ii) repeat the first step until no further targets are available. Here, I propose that all branching involved in spreading is maximally binary, much like in prosody (reviewed in the previous section).

- (84) Strict Binariness  
All branching is maximally binary.

The consequence of Strict Binariness (84) is a creation of recursive nodes. Another restriction of BDT is that the two dependent root nodes are not equivalent. Spreading creates heads before dependents. This means that spreading to one target will result in exactly one head on triggering root node and one non-head, as defined in (85). A head of the feature [f] is a root node that (i) is associated with [f] and (ii) is associated with a binary branching node of [f].

- (85) Feature head (provisional)  
Iff  $\times_i \neq \times_j$  and  $\times_i, \times_j$  are associated with the same node of the feature [f], exactly one of the statements (a), (b) is true.
- a.  $\times_i$  is a head of [f].
  - b.  $\times_j$  is a head of [f].

We have now seen that for every pair of root nodes associated with the same feature, exactly one is a head. The remaining issue is which of the two is a head. In this thesis, I will assume that triggers are always heads. A trigger in this context is a segment that (i) is associated with a feature in the input and output and (ii) triggers spreading. A trigger of an f-spreading pattern is always a head of [f], as in (86).

- (86) Triggers are heads  
Let Input =  $i_1 i_2 i_3 \dots i_n$ .  
Let Output =  $o_1 o_2 o_3 \dots o_n$ .

Let  $i_i \Re o_j$ .

Iff  $i_i$ ,  $o_j$ , and  $o_k$  are associated with the autosegment  $[f]$ ,  $o_j$  is a head of  $[f]$ .

The above restrictions on heads (85) and triggers (86) have one implication for all other root nodes associated with the relevant feature. Because there is one head for every pair of root nodes, a string of  $n$  segments associated with the same feature will have  $n - 1$  heads. Since triggers are never dependents, the only root node that is not a head, will be the final target.

In order to make the distinction between a head and a dependent clear, I propose a slight modification to how feature spreading is represented graphically. In (87), we see rightwards spreading of a feature  $[f]$  from the leftmost root node  $\times_1$  that targets all root nodes. The representation in (87) is a notational variant of the second representation in (83). Capital letters designate heads of  $[f]$  and non-capitals designate that a feature is realized on a particular root node. The square brackets designate the trigger. In (87), there is only one instance of a feature  $[f]$ , associated with five segments. Of these, four are headed and one is not headed. Non-capitals appear redundant at this point and can be omitted. An association line linking a root node to a head is sufficient to express spreading of a feature to a segment. I will reintroduce the full notation in chapter 5 and use it to distinguish between targets and transparent segments.<sup>2</sup>

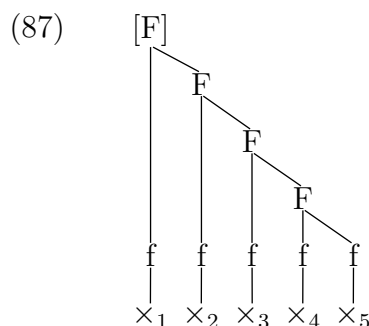

To summarize, BDT places two restrictions on feature spreading. First, maximally binary branching is allowed, and spreading to multiple targets creates recursive binary domains. Second, these domains are headed. Binarity and headedness are well supported in other areas of linguistic theory and are reviewed in the next section. I revisit headedness in section 5.2.2.

<sup>2</sup>In Jurgec (2009, 2010b), I proposed that feature domains are overlapping rather than recursive. The representation here has been developed in collaboration with Bruce Morén-Duolljá.

### 4.2.3 Headedness, binarity, and recursion

Headedness is a relation found throughout prosodic theory. Any prosodic constituent has a head (Lieberman & Prince 1977; Nespor & Vogel 1986; Hayes 1995; de Lacy 2006). For example, each foot must have a head (syllable or mora). Similarly, a prosodic word must be headed by a foot or a syllable. In prosodic theory, heads may have independent cues of prominence, such as phonetic correlates of stress (intensity, duration, formant frequencies) or segmental distributions (e.g. more segments are possible on heads than on dependents, see Beckman 1998; Benua 1997; Crosswhite 2001; Smith 2005; de Lacy 2006).

Headedness has also been proposed for feature spreading, which is a notion that BDT shares with other recent approaches to feature domains (Cassimjee & Kisseberth 1989; Kisseberth 1994; Cole & Kisseberth 1995a,b; Cassimjee & Kisseberth 1998; McCarthy 2004; Smolensky 2006; Potts et al. 2010). Most of these accounts see the triggering segment as a head, while all the undergoers are dependents. BDT differs in three ways from other feature domain theories. First, BDT allows maximally binary domains with one head and one dependent, rather than an unbounded domain with any number of dependents. Second, domains are recursive, creating heads on all but the final target. Third, heads in BDT represent only structural prominence, and not a separate instance of some autosegment. The distinction between a head and an autosegment builds on Hyde's (2002, 2007) proposal which divorces prosodic prominence and footing. Here, domains similarly represent only structural prominence with respect to the spreading feature. The evidence for feature heads is phonological, namely the existence of icy targets. Icy targets can be associated with a feature, but inhibit feature spreading at the same time. This can be attributed to the fact that icy targets cannot be heads, although they are associated with a particular feature.

Finally, headedness has also been used elsewhere in phonology (see Dresher & van der Hulst 1998 for a review). In Dependency Phonology, for example, features within segments may be headed (Anderson & Ewen 1987; van der Hulst 1989).<sup>3</sup> We can conclude that headedness is well established in phonology, although in slightly different terms than the current proposal.

The idea that feature spreading involves a binary constituent is also consistent with many other aspects of phonological theory. For example, feet are standardly assumed to consist of not more than two syllables, and syllables most commonly consist of not more than two moras (e.g. Hayes 1995). Prosodic words (Itô & Mester 1992; Prince & Smolensky 1993/2004; Ussishkin 2000; Karvonen 2005; Kabak & Revithiadou 2009) and phonological phrases (Nespor & Vogel 1986; Ghini 1993; Inkelas & Zec 1995; Selkirk 2000; Truckenbrodt & Sandalo 2002;

---

<sup>3</sup>Note that BDT does not state anything about the feature content of individual segments, but merely posits headedness in feature spreading.



Truckenbrodt 2007) have also been analyzed as binary. As regards morphological domains, Lahrouchi (2010) analyzes Tashlhiyt roots as consisting of binary branching constituents. The proposal to extend binarity to feature spreading is thus not surprising.

Binarity is also found in feature spreading processes involving tone. Bantu languages often show spreading within a binary domain (see Kisseberth & Odden 2003 for an overview): Chichewa (Myers 1999), Cilungu (Bickmore 2007), Ekegusii (Bickmore 1997), Enakhauwa (Cassimjee & Kisseberth 1998), Kikuyu (Clements & Ford 1979; Clements 1984), Kinyarwanda (Myers 2003), Rimi (Myers 1997), Setswana (Mmusi 1992; Cassimjee & Kisseberth 1998), Shona (Odden 1981; Myers 1987), and many others. Similar patterns are also found in various Japanese dialects (Nitta 2001; Odden 2001) and in Serbo-Croatian (Inkelas & Zec 1988; Zec 1999; Becker 2007).

The third element of the theory is recursion. Unlike the other two phenomena, recursion does not appear to be as prevalent in prosodic theory. However, most early work on prosody posits recursive footing for what has later been established as unparsed material (Liberman & Prince 1977; Kiparsky 1979; McCarthy 1979, 1982; Hayes 1980; Selkirk 1980b; Halle & Vergnaud 1987). Similar proposals have been put forward more recently by Grijzenhout (1990) and Rice (2011). As regards lower prosodic constituents, Kaye et al. (1990) and Smith (1999) suggest that syllables and syllable constituents are recursive. Finally, prosodic units larger than the syllable are often considered to be recursive (Nespor & Vogel 1986; Peperkamp 1997; Fox 2000; Truckenbrodt 2007; Kabak & Revithiadou 2009; Itô & Mester 2008b, 2009). van der Hulst (2010) provides an overview of recursion in phonological theory. Recursion is proposed standardly for segment-internal structure (Sagey 1990; Odden 1994; Clements & Hume 1995; Morén 2003, 2006b). An example of this kind is that the vowel place node is dependent of consonant place node. We can conclude that recursion is often used in phonology, and that extending recursion to assimilation is not surprising.

BDT assumes recursive domains. However, the data presented in this chapter do not offer evidence whether domains should be recursive or overlapping. That is, both models are equally adept at explaining icy targets. The choice for recursive rather than overlapping domains is largely due to the early autosegmental models. In the literature, overlapping structures are only slightly less common than recursive. A standard example of this type are overlapping syllables which create ambisyllabic segments (Kahn 1976). A more recent proposal extends the same idea to overlapping footing (Hyde 2001, 2002, 2007).

In this chapter and throughout this thesis, I show that feature spreading and prosody are more alike than previously assumed. Both involve headed binary domains. Thus, it makes sense to use the same kind of representations for both

phenomena. BDT transfers prosodic association lines to segmental features and feature spreading in particular. The differences between the two phenomena are due to other factors. On the one hand, prosody prefers maximum contrast between adjacent elements, leading to sequences of peaks and troughs. On the other hand, feature spreading is a neutralization process. Neutralization reduces contrast between segments that it affects. In feature spreading, some phonological properties of targets are neutralized when affected by a spreading feature. In this context, headedness expresses a greater degree of neutralization. Headed targets show a greater degree of neutralization than non-headed ones. In particular, regular targets affect subsequent segments much like triggers, while icy targets do not and allow full contrast in all subsequent segments. Hence, regular targets are better or stronger neutralizers than icy targets. I will further build on this point in chapters 5 and 7, where I argue that transparent segments display a lower degree of neutralization than icy targets, while triggers display a greater degree of neutralization than regular targets. This is related to the fact that there are constraints that refer solely to feature heads or subsets thereof.

#### 4.2.4 Constraints on heads

BDT is a representational theory that makes a distinction between two types of segments. When linked to the same autosegment, some root nodes are headed, while others are not. However, such a distinction is inert on its own, and needs a separate mechanism to affect phonological computation. In OT, such a mechanism are constraints. In this section, I present constraints that penalize segments containing a head of a feature.

Feature co-occurrence constraints are one of the most commonly used OT constraints. These penalize root nodes that are associated with two (or more) features, as in (88).

- (88) \* $[f\ g]$   
 Assign a violation for every root node  $\times$ , iff  $\times$  is associated with features  $[f]$  and  $[g]$ .

The feature co-occurrence constraint in (88) is violated by a root node associated with two features  $[f]$  and  $[g]$ , as we have seen in (78), which also shows that this constraint is not sufficient to account for icy targets.

Recall that feature spreading in BDT involves two distinct components. The first component is adding associations between a feature to a root node. The second component is adding heads on some segments but not on others. In the current context, both components are enforced by alignment constraints and particular restrictions on feature spreading (namely, all branching is maximally binary). When

a specific alignment constraint outranks all other constraints, the relevant feature gets linked to all root nodes within a domain. In addition, all but the final target gets a head. The final target does not get a head because no further spreading is needed. Furthermore, the final target will never contain a head because heads come at a price. Containing some structure is typically a more marked situation than not containing that structure. More specifically, containing a head is a more marked situation than not containing a head.

Icy targets can be associated with a feature, but cannot be heads of a particular feature when they also have some other feature. This calls for a more specific markedness constraint: a positional markedness constraint (Zoll 1998b; Piggott 2000; Crosswhite 2001; Smith 2005; de Lacy 2001, 2002, 2006). The rationale behind positional markedness constraints is that prominent positions (onsets, initial syllables, stressed positions) make additional restrictions on what segments (or features) they permit. Positional markedness constraints may for instance refer to heads of prosodic constituents. Some languages do not allow syllable heads (nuclei) to be consonants; a positional markedness constraint prohibits a combination of a syllable head and a consonant (Itô 1986/1988; Zec 1988/1994, 1995; Broselow et al. 1997; Morén 2000, 1999/2001; Gouskova 2004; Prince & Smolensky 1993/2004). Other languages make restrictions on what is a possible foot head or a possible word head, enforced by constraints on foot heads and syllable heads, respectively (Kenstowicz 1997; de Lacy 2001, 2002, 2004, 2006, 2007; Gouskova 2010). Similar constraints can be extended to feature heads in (89). The constraint is violated whenever a head of a feature [f] is also associated with a feature [g]. In the notation presented in (87), heads are marked by capitals, and this is reflected in the constraint name, which also contains a capital to designate heads—\*[F g].

(89) \*[F g]

a. Assign a violation mark for every root node  $\times$ , iff  $\times$  is a Head of a feature [f] and  $\times$  is associated with [g].

b. \*  $\begin{array}{c} [F] \\ \swarrow \searrow \\ \times \quad \times \\ | \\ [g] \end{array}$

A constraint on heads \*[F g] differs from a feature co-occurrence constraint \*[f g]. While the former penalizes only root nodes that are both heads of [f] and are associated with a [g], the latter penalizes all segments that are associated with [f] and [g]. The dependents of [f] never violate \*[F g], while they do violate \*[f g] if they also contain [g]. In other words, the two constraints are in a stringency relation: any output that violates \*[F g] also violates \*[f g]. In contrast, outputs with a segment associated with [f] and [g] but without spreading violate \*[f g], but not \*[F g].

The constraint  $*[F\ g]$  may be alternatively abbreviated as  $*\Delta_{[f]}[g]$ . This notation makes it possible to consider the constraint as a part of a larger class of constraints against headed structures ( $*\Delta$ ). Constraints on heads have been used extensively in works on the interaction of prosody, segmental features and sonority (Kenstowicz 1997; Morén 1999/2001; de Lacy 2001, 2002, 2004, 2006, 2007). In this context, the headed category is a prosodic domain rather than a feature. For example, a constraint may prohibit a head of a prosodic word to contain a segment of a particular sonority. In Nganasan, for instance, stress is generally penultimate, but not when stress would fall on a schwa (de Lacy 2002; Vaysman 2008). The constraint that penalizes word stress on schwa is  $*\Delta_{\omega\emptyset}$  ( $\equiv$  Assign a violation mark for every schwa that is a Head of a PWd).<sup>4</sup>

Yet the constraints of the type  $*\Delta_{\omega\emptyset}$  are formally slightly different from the proposed constraint  $*\Delta_{[f]}[g]$  in (89). In particular, the categories in  $*\Delta_{\omega\emptyset}$  seem to be in a strictly hierarchical relationship:  $*\Delta_{\omega\emptyset}$  is a valid constraint, while  $*\Delta_{\omega}$  is not. In other words, the headed category (Prosodic Word in this case) needs to include the other (sonority level on the level of a segment). I propose that the set of these constraints be extended from strict hierarchy to hierarchy (i.e., inclusive of categories of the same type). The constraint  $*\Delta_{[f]}[g]$  is such a constraint, in which the categories are alike— $[f]$  and  $[g]$  are both features. Constraints could thus also refer to prosodic categories of the same level. For example, the constraint  $*\Delta_{\sigma}\sigma''$  refers to syllable heads. The two categories of the latter constraint are of the same prosodic level, but they are not identical, parallel to  $[f]$  and  $[g]$ , which are non-identical features. The constraint  $*\Delta_{\sigma}\sigma''$  penalizes all segments that are heads of one syllable while also being a part of another syllable. In other words, the constraint prohibits ambisyllabic nuclei, while allowing for ambisyllabic onsets and codas. To the best of my knowledge, no language permits ambisyllabic nuclei but not ambisyllabic onsets/codas, while the opposite is attested—for example, in North Saami (Bye 2002). This suggests that the support for  $*\Delta_{[f]}[g]$  may also come from other areas of phonology.

In the present context, constraints on heads refer exclusively to features. Smolensky (2006) first uses constraints with a similar effect, but with a different formalization. According to his proposal, each feature domain must be headed. When the constraint  $*\text{HEAD}$  is in Local Conjunction with another markedness constraint as in  $*\text{HEAD}\&*[g]$ , the conjoined constraint penalizes all heads that contain  $[g]$ .

---

<sup>4</sup>The committee asks how the constraint  $*\Delta_{\omega\emptyset}$  can be formalized using features. This question makes sense only under two assumptions. The first is that only privative features allowed. The second is that  $*\Delta_{\omega\emptyset}$  must be formalized in terms of segmental features. Neither of these assumptions is necessary for the model advanced in this thesis. As regards the second assumption, the constraint  $*\Delta_{\omega\emptyset}$  can be formalized in terms of sonority, as proposed by Kenstowicz (1997); de Lacy (2001, 2006); Vaysman (2008).

Smolensky's account differs from BDT in the distribution of heads. Consequently, the effect of a constraint on heads is significantly different. I will compare feature domain theories with BDT in section 4.6.1.

This concludes the discussion of the feature spreading mechanism, its formal properties and the constraints that may inhibit spreading. I now return to Icelandic which was briefly discussed in section 4.1 and give a full account of icy targets in Icelandic.

## 4.3 Icelandic

Recall section 4.1 which briefly discussed u-umlaut in Icelandic. The particular pattern of interest involves fronting and rounding of /a/ to [œ], with the derived [œ] terminating spreading. I attempted to account for the data using classic autosegmental representations and OT constraints that refer to them. This attempt ultimately failed, because no constraint can stop spreading on a target. In response to this challenge, I introduced a representational modification of feature spreading (section 4.2). The basic idea of the new proposal is that branching is maximally binary and creates recursive nodes and domains. Each binary node is associated to a head and a dependent root node. This allows for a distinction between two types of targets: regular targets can be either heads or dependents of a feature, whereas icy targets can be dependents, but not heads.

Icy targets are found in Icelandic. In particular, /a/ undergoes assimilation and becomes [œ], but [œ] terminates spreading. This is because [œ] can be associated with the spreading feature, but cannot be its head. In other words, heads of the spreading feature in Icelandic cannot be open. Such a conclusion is further supported by a separate reduction pattern, which raises unstressed [œ] to [ɤ]. These derived vowels are not open and can serve as heads. Consequently, spreading is not terminated, but affects further targets.

In this section, I analyze the icy target pattern found in Icelandic. In section 4.3.1, I review the Icelandic data. In section 4.3.2, I give an analysis which is based on alignment constraints developed in chapters 2 and 3, complemented by constraints on feature heads (section 4.2.4).

### 4.3.1 Data

Icelandic u-umlaut is well described and has a long tradition of analyses within Generative Phonology (Anderson 1972, 1974, 1976a,b; Anderson & Iverson 1976; Howard 1972; Orešnik 1975, 1977; Richter 1982; Kiparsky 1984, 1985; Grijzenhout 1990; Árnason 1992; Karvonen & Sherman 1997; Gibson & Ringen 2000). In what follows, I offer a new insight into the data.

Icelandic has eight contrastive vowel qualities. The vowel inventory in (90) is complemented by features used in the analysis below. While other features are also needed to distinguish the full vowel inventory, these are not directly relevant to u-umlaut.

(90) Icelandic vowel inventory (Thráinsson 1994)

|        |         |   |        |
|--------|---------|---|--------|
|        | [front] |   | [back] |
|        | i       |   | u      |
|        | ɪ       | ʏ |        |
| [open] | ɛ       | œ | a    ɔ |
|        | [rd]    |   | [rd]   |

Note that Icelandic distinguishes tense and lax high vowels. Furthermore, there are two front round vowels, one of which, [ʏ], is high, while the other, [œ], is open. The particular features I will be using in the analysis of Icelandic are rather standard, with one exception. The four non-high vowels have the feature [open] rather than [low]. Either of the two features would work, but my particular choice in favor of [open] has to do with cross-linguistic typological implications rather than specifically with the Icelandic data. Recall that I have already used [open] in the analysis of Wolof vowel harmony in section 3.2.3. In section 8.4.5 I provide an argument for [open] as a targeted structure in rounding harmony.

U-umlaut is triggered by a front, round vowel /ʏ/ which targets /a/ and turns it into [œ]. In terms of features, u-umlaut can be analyzed as spreading of [front] and [round] from a front high lax vowel /ʏ/ targeting only [open] vowels. Interestingly, only /ʏ/ triggers the alternation and only /a/ is affected. No other vowel participates. This is a puzzling fact, which suggests that the features [front] and [round] cannot spread separately; only a segment that contains them both can serve as trigger, and only a target that lacks both of them can serve as a target. The pattern in which two features can spread jointly, but not separately is referred to as the sour grapes problem in the literature (Padgett 1995). This issue will be further discussed in section 4.3.2.

The data in (91) show alternations in monosyllables when followed by a suffix. U-umlaut is triggered by several suffixes, which all contain an underlying /ʏ/. The data in this section come from Anderson (1972, 1974), Orešnik (1975, 1977) and Árnason (1992). I have also consulted Gunnar Hrafn Hrafnbjargarson for additional data.<sup>5</sup> Only vowels are transcribed.

---

<sup>5</sup>I would also like to thank Janez Orešnik for clarifying some data related issues.

|      |                           |                 |                     |                     |
|------|---------------------------|-----------------|---------------------|---------------------|
| (91) | U-umlaut in monosyllables |                 |                     |                     |
|      | st[ <u>a</u> ]ð           | ‘place.ACC.SG’  | ‘st[œ]ð[ɣ]m         | ‘place.DAT.PL’      |
|      | b[ <u>a</u> ]nki          | ‘bank.NOM.SG’   | ‘b[œ]nk[ɣ]m         | ‘bank.DAT.PL’       |
|      | ‘g[ <u>a</u> ]ta          | ‘street.NOM.SG’ | ‘g[œ]t[ɣ]           | ‘street.NOM/ACC.PL’ |
|      | f[ <u>a</u> ]ra           | ‘go, travel’    | f[œ]r[ɣ]ll          | ‘rambling’          |
|      | ‘s[ <u>a</u> ]ga          | ‘history’       | ‘s[œ]g[ɣ](,leg[ɣ]r) | ‘historical’        |

As pointed out in the introduction, vowel reduction is a separate rule which raises all unstressed/non-initial [œ] to [ɣ]. The forms in (92) show that the output [a] in the nominative singular is not subject to vowel reduction, while [œ] is. Icelandic vowel reduction needs a separate account, which is outside the current discussion (see Crosswhite 2001; Smith 2005; de Lacy 2006, for independent proposals). Reduced roots will be analyzed later in (101) and (130).

|      |                                                 |                         |            |
|------|-------------------------------------------------|-------------------------|------------|
| (92) | Vowel reduction                                 |                         |            |
| a.   | œ → ɣ / σ C <sub>0</sub> _____ C <sub>0</sub> ɣ |                         |            |
| b.   | NOM.SG                                          | DAT.PL                  |            |
|      | ‘h[ɛ]r[ <u>a</u> ]ð                             | ‘h[ɛ]r[ <u>ɣ</u> ]ð[ɣ]m | ‘district’ |
|      | ‘m[ɛ]ð[ <u>a</u> ]l                             | ‘m[ɛ]ð[ <u>ɣ</u> ]l[ɣ]m | ‘drug’     |
|      | ‘[ɔ]ð[ <u>a</u> ]l                              | ‘[ɔ]ð[ <u>ɣ</u> ]l[ɣ]m  | ‘allodium’ |

Vowel reduction interacts with u-umlaut. When [œ] surfaces as a result of u-umlaut, [œ] is raised to [ɣ], which creates a further trigger. In turn, u-umlaut applies again, resulting in an apparently iterative rule. Initial [œ] never reduces. More examples are provided in (93).

|      |                                |                          |                   |
|------|--------------------------------|--------------------------|-------------------|
| (93) | Polysyllables with reduction   |                          |                   |
|      | NOM.SG                         | DAT/ACC.PL               |                   |
|      | ‘f[ <u>a</u> ]tn[ <u>a</u> ]ð  | ‘f[œ]tn[ <u>ɣ</u> ]ð[ɣ]m | ‘suit of clothes’ |
|      | ‘b[ <u>a</u> ]k[ <u>a</u> ]ri  | ‘b[œ]k[ <u>ɣ</u> ]r[ɣ]m  | ‘baker’           |
|      | ‘b[ <u>a</u> ]n[ <u>a</u> ]ni  | ‘b[œ]n[ <u>ɣ</u> ]n[ɣ]m  | ‘banana’          |
|      | ‘[ <u>a</u> ]lt[ <u>a</u> ]ri  | ‘[œ]lt[ <u>ɣ</u> ]r[ɣ]   | ‘altar’           |
|      | ‘k[ <u>a</u> ]st[ <u>a</u> ]li | ‘k[œ]st[ <u>ɣ</u> ]l[ɣ]m | ‘citadel’         |

A class of words does not exhibit vowel reduction, as shown in (94). In these roots, u-umlaut is limited to the last vowel of the root. The restriction of the root-final vowel does not depend on secondary stress. For example, both ‘[a]tl[œ]s[ɣ]m’ ‘atlas-DAT.PL’ and ‘[a]lm[a],n[œ]k[ɣ]m’ ‘calendar-DAT.PL’ show no reduction, despite the fact that the root-final vowel has secondary stress in ‘calendar’, but not in ‘atlas’. Grijzenhout (1990) builds on this fact and proposes recursive feet to account for the pattern. While her approach works for Icelandic, it does not for other cases of icy targets, to be discussed in the subsequent sections.

|      |                                  |                                               |            |
|------|----------------------------------|-----------------------------------------------|------------|
| (94) | Polysyllables without reduction  |                                               |            |
|      | NOM.SG                           | DAT.PL                                        |            |
|      | '[a]tl[ <u>a</u> ]s              | '[a]tl[ <u>œ</u> ]s[ <u>ɣ</u> ]m              | 'atlas'    |
|      | 'kv[a]ðr[ <u>a</u> ]t            | 'kv[a]ðr[ <u>œ</u> ]t[ <u>ɣ</u> ]m            | 'square'   |
|      | 'sk[a]nd[ <u>a</u> ]li           | 'sk[a]nd[ <u>œ</u> ]l[ <u>ɣ</u> ]m            | 'scandal'  |
|      | 'k[a]r[ <u>a</u> ]t              | 'k[a]r[ <u>œ</u> ]t[ <u>ɣ</u> ]m              | 'carat'    |
|      | '[a]lm[ <u>a</u> ]n[ <u>a</u> ]k | '[a]lm[ <u>a</u> ]n[ <u>œ</u> ]k[ <u>ɣ</u> ]m | 'calendar' |

In the spirit of full disclosure, I address three further points regarding the data, which show that several other factors affect u-umlaut. These, however, do not invalidate the generalization about icy targets in Icelandic. First, not all [ɣ]'s trigger u-umlaut. The data in (95) show that the epenthetic [ɣ] surfacing before a suffix containing *r* has no effect on the preceding [a]. Such lack of spreading from an epenthetic segment is not surprising because many other languages also exhibit it (see Finley 2008 for a review). Karvonen & Sherman (1997, 1998) analyze the interaction of u-umlaut with epenthesis as opaque using Sympathy Theory (McCarthy 1999).

|      |                |                                                                       |                                     |
|------|----------------|-----------------------------------------------------------------------|-------------------------------------|
| (95) | Epenthetic [ɣ] |                                                                       |                                     |
|      | a.             | ɣ-epenthesis                                                          |                                     |
|      |                | $\emptyset \rightarrow \gamma / C \text{ \_\_\_\_\_\_ } r ]_{\omega}$ |                                     |
|      | b.             | /dag-r/                                                               | dag[ɣ]r 'day.NOM.SG                 |
|      |                | /tek-r/                                                               | tek[ɣ]r 'take.3SG.PRES              |
|      |                | /stað-r/                                                              | stað[ɣ]r 'place.NOM.SG              |
|      |                | /albansk-r/                                                           | albansk[ɣ]r 'Albanian.NOM.SG        |
|      |                | /dasaðast-r/                                                          | dasaðast[ɣ]r 'most exhausted.NOM.SG |
|      |                | /nir-r/                                                               | nir 'new.M.NOM.SG                   |
|      |                | /elska-r/                                                             | elskar 'love.3SG.PRES               |

An alternative interpretation of the data in (95) is also feasible. Recall the data in this section and the observation that u-umlaut involves a trigger in a suffix and a target in a root. Given the Consistency of Exponence (McCarthy & Prince 1993b), an epenthetic [ɣ] has no morphological affiliation. Hence, the trigger does not satisfy the condition to belong to a suffix, and the lack of u-umlaut is expected. The restriction that triggers need to be in a suffix is further supported by forms in (96). These show u-umlaut in the absence of a segmental trigger. The alternations can be analyzed as triggered by an affix consisting only of floating features. These features dock on the root-final vowel (and spread from there) just as if they were associated with an underlying /ɣ/.



|      |                                   |                      |             |                      |
|------|-----------------------------------|----------------------|-------------|----------------------|
| (96) | Floating affixes trigger u-umlaut |                      |             |                      |
|      | [a]nn[a]r                         | ‘other.NOM.SG.M’     | [œ]nn[ɣ]r   | ‘other.NOM.SG.F’     |
|      | g[a]m[a]ll                        | ‘old.NOM.SG.M’       | g[œ]m[ɣ]l   | ‘old.NOM.SG.F’       |
|      | [a]t[a]ll                         | ‘energetic.NOM.SG.M’ | [œ]t[ɣ]l    | ‘energetic.NOM.SG.F’ |
|      | b[a]rn                            | ‘child.NOM.SG’       | b[œ]rn      | ‘child.NOM/ACC.PL’   |
|      | j[a]p[a]nsk[ɣ]r                   | ‘Japanese.NOM.SG.M’  | j[a]p[œ]nsk | ‘Japanese.NOM.SG.F’  |

The final consideration concerns variation. The data in (97) reveal that most polysyllabic forms (including the ones provided so far) have multiple variant pronunciations. Each of the nouns below has three possible variant pronunciations in the dative plural, but only one in the nominative singular. Variant (a) exhibits both u-umlaut and reduction, parallel to the forms in (93). Variant (b) shows u-umlaut, but no reduction, comparable to forms in (94). Variant (c) has no reduction, but u-umlaut has applied throughout the root.

|      |             |                 |                 |                          |
|------|-------------|-----------------|-----------------|--------------------------|
| (97) | Variation   |                 |                 |                          |
|      | NOM.SG      | DAT.PL          |                 |                          |
|      |             | Reduced         | Unreduced       |                          |
|      |             |                 | Icy targets     | No icy targets           |
|      |             | a.              | b.              | c.                       |
|      | kj[a]r[a]ld | kj[œ]r[ɣ]ld[ɣ]m | kj[a]r[œ]ld[ɣ]m | kj[œ]r[œ]ld[ɣ]m ‘cask’   |
|      | b[a]n[a]ni  | b[œ]n[ɣ]n[ɣ]m   | b[a]n[œ]n[ɣ]m   | b[œ]n[œ]n[ɣ]m ‘banana’   |
|      | k[a]st[a]li | k[œ]st[ɣ]l[ɣ]m  | k[a]st[œ]l[ɣ]m  | k[œ]st[œ]l[ɣ]m ‘citadel’ |

Variants (a) and (b) are the focus of the current analysis. For most forms, I will argue that variation concerning reduction has to be lexically specified: some roots exhibit reduction, others do not. The nouns in (97), however, show more variability in this respect, and multiple forms are found across speakers. In the next section, I will analyze only variants (a) and (b) which show icy targets.

### 4.3.2 Analysis

In this section, I give an analysis of icy targets in Icelandic. I first introduce the constraints, followed by an evaluation of a form without reduction. Then I move on to reduced forms. Finally, I discuss the remaining issues.

#### Roots without reduction

Recall that u-umlaut can be analyzed in terms of spreading of [round] and [front]. Furthermore, recall that a high front round vowel /ɥ/ acts as a trigger, targeting only a back open unrounded vowel /a/, turning it into [œ]. U-umlaut thus involves two rather different features that always spread together. This explains why other segments are not affected and why other segments do not trigger the alternation.

For example, Icelandic also has [u] in its inventory (90), yet [u] never triggers rounding nor undergoes fronting. A phenomenon of joint spreading of two features, which fail to spread separately is a case of the sour grapes problem.

There are several ways of analyzing a sour grapes pattern. One option is representational, in which a feature node dominating [front] and [round] spreads rather than two separate features. For example, V-place is such a feature node in most autosegmental accounts (Clements 1991; Clements & Hume 1995; Sagey 1990; Odden 1991; Morén 2003, 2006b). Segments that already have this feature node associated with only one of the two features are not targeted and do not trigger any spreading. In this thesis, I approach assimilation without any reference to the segment-internal organization of features. As a result, I will not take this representational approach.

Another option is constraint-based. Conjoined faithfulness and markedness constraints (e.g. Baković 2000; Lubowicz 2002b) can model the patterns in which two features must spread, but one cannot. I demonstrate this point for [ɔ]. The ranking  $\text{MAXLINK}[\text{round}] \gg \text{DEPLINK}[\text{front}] \&_{\text{seg}} * \omega[\text{vowel}, \text{round}]$  penalizes candidates that only spread [front] but not [round]. Since [ɔ] already contains [round] (which is retained due to the high ranked  $\text{MAXLINK}[\text{round}]$ ) spreading of [front] alone incurs a violation of the conjoined constraint. In contrast, the mapping /a/ → [œ] does not violate the constraint, since [front] and [round] spread, and the alignment constraint in  $\text{DEPLINK}[\text{front}] \&_{\text{seg}} * \omega[\text{vowel}, \text{round}]$  is not violated. The sour grapes problem is a challenge for classic OT and the Icelandic pattern is no exception. Here I offer no further account why the two features must spread jointly, but not independently.

Spreading of multiple features is cross-linguistically quite common. Recall that in the current approach, spreading is attributed to alignment constraints. As we have seen in section 4.1, one of the alignment constraints has [round] as the spreading feature and targets vowels— $*\omega[\text{vowel}, \text{round}]$  (79). The other constraint has [front] as the spreading feature and targets vowels— $*\omega[\text{vowel}, \text{front}]$ . These two constraints are independent, although their effect in Icelandic overlaps. We know this because of the following two cross-linguistic generalizations. First, many languages exhibit only rounding (see section 8.4 for a typological overview) or fronting/backness assimilation (e.g. Finnish in section 2.2.2 and 5.5). Second, many languages have assimilations which can be analyzed as spreading of multiple features (see Krämer 2003 for an overview). For example, Dagaare has a fronting/backness and ATR/RTR harmony (Bodomo 1997), while Kimatumbi has a height and ATR harmony (Odden 1991, 1994). Kàlòŋ shows an ATR, fronting/backness and rounding harmony (Hyman 2002; Morén 2006a). Finally, Yucatec Maya (Krämer 2001) and Ainu (Itô 1984) spread all vocalic features. Hence, Icelandic is not alone in that it exhibits multiple concurrent feature spread-

ing processes—fronting and rounding. Each of the two features needs a separate set of constraints. In what follows, I analyze rounding, and a parallel analysis is required for fronting.

I now resume the account of Icelandic where I left off in section 4.1. In Icelandic, the alignment constraint preferring spreading outranks the faithfulness constraint that inhibits spreading. If it were the opposite, no spreading would have occurred. The alignment constraint is \*PWd[vowel, round]—(79), repeated in (98).

- (98) \*PWd[vowel, round]
- a. \*⟨PWd, [round], vowel⟩ /  $\begin{array}{c} \text{PWd} \\ \swarrow \quad \searrow \\ \text{vowel} \quad \text{[round]} \end{array}$
- b. Assign a violation mark for every triplet ⟨PWd, [round], vowel⟩, iff PWd is associated with [round] and vowel and vowel ≺ [round].

The alignment constraint \*PWd[vowel, round] in (98) outranks the faithfulness constraint against linking DEPLINK[round]. One effect of this ranking is that only vowels are targeted. Another prediction is that *all* vowels within a word are targeted, which is not what is attested. There must be another constraint, which inhibits spreading and is ranked above both constraints. In section 4.2, I claimed that spreading is restricted to binary branching. When spreading to multiple targets is preferred, recursive domains are added. Each domain contains a headed and a non-headed root node. Icy targets can be associated with a feature, but cannot contain a head, which is why they terminate spreading. Recall the constraint template against heads of features in (89). The constraint \*[F g] is violated by a root node which is associated with [g], while also being a head of [f].

In Icelandic, [œ] is an icy target: spreading is terminated by an open vowel [œ], but not by a high vowel [y] (cf. section 4.3.1). Icy targets cannot be headed and thus violate a constraint against feature heads. The particular constraint is violated by [œ], but not by [y]. If so, heads of the feature [round] cannot be [open]. The constraint \*[ROUND open] in (99) penalizes heads of [round] that are also associated with [open]. Heads are marked by capitals.

- (99) \*[ROUND open]
- a. Assign a violation mark for every root node ×, iff × is a Head of the feature [round] and × is associated with [open].
- b. \*  $\begin{array}{c} \text{[ROUND]} \\ \swarrow \quad \searrow \\ \times \quad \times \\ \quad \quad \quad | \\ \quad \quad \quad \text{[open]} \end{array}$

I first analyze the forms without reduction, followed by forms with reduction. In the forms without reduction like  $j[a]p[\text{œ}]n[\text{ɣ}]m$  ‘Japanese.DAT.PL’ the constraint  $*\omega[\text{vowel, round}]$  (98) is outranked by  $*[\text{ROUND open}]$  (99). The ranking is shown in (100). Candidate (a) shows no spreading and does not contain any feature heads. Candidate (b) has spreading to one target, resulting in an icy target. Recall that a branching feature node is marked by a capital, and the root node containing a head is aligned with the corresponding feature node. In addition, triggers (or segments with no spreading) contain square brackets to indicate a single instance of a feature. Candidate (c) shows total spreading and candidate (d) shows additional raising of the second vowel to  $[\text{ɣ}]$ .

(100) japœnym ‘Japanese.DAT.PL’

|                  | $\begin{array}{c} \text{[rd]} \\   \\ / j \ a \ p \ a \ n - \text{ɣ} \ m \ / \\   \quad   \\ \text{[op]} \ \text{[op]} \end{array}$         |           |          |                     |
|------------------|---------------------------------------------------------------------------------------------------------------------------------------------|-----------|----------|---------------------|
|                  | $\begin{array}{c} \text{[rd]} \\   \\ j \ a \ p \ a \ n \ \text{ɣ} \ m \\   \quad   \\ \text{[op]} \ \text{[op]} \end{array}$               | MAXLK[op] | *[RD op] | * $\omega$ [vow,rd] |
| a.               |                                                                                                                                             |           |          | DEPLK[rd]           |
|                  | $\begin{array}{c} \text{[rd]} \\   \\ j \ a \ p \ a \ n \ \text{ɣ} \ m \\   \quad   \\ \text{[op]} \ \text{[op]} \end{array}$               |           |          | **!                 |
|                  | $\begin{array}{c} \text{[RD]} \\   \\ j \ a \ p \ \text{œ} \ n \ \text{ɣ} \ m \\   \quad   \\ \text{[op]} \ \text{[op]} \end{array}$        |           |          | *                   |
| b. $\rightarrow$ |                                                                                                                                             |           |          | *                   |
|                  | $\begin{array}{c} \text{[RD]} \\   \\ j \ \text{œ} \ p \ \text{œ} \ n \ \text{ɣ} \ m \\   \quad   \\ \text{[op]} \ \text{[op]} \end{array}$ |           |          |                     |
| c.               |                                                                                                                                             |           | *!       | **                  |
|                  | $\begin{array}{c} \text{[RD]} \\   \\ j \ \text{œ} \ p \ \text{ɣ} \ n \ \text{ɣ} \ m \\   \quad   \\ \text{[op]} \end{array}$               |           |          |                     |
| d.               |                                                                                                                                             | *!        |          | **                  |

Recall tableau (81) and the fact that the alignment and faithfulness constraints cannot produce an icy target candidate. By introducing heads in the representation of spreading and constraints that refer to them, the predictions are different. Alignment prefers spreading to most targets. Candidate (100-c) satisfies  $*\omega[\text{vowel, round}]$  perfectly. However, this candidate fatally violates the constraint on heads  $*[\text{ROUND open}]$ . Candidate (a) violates  $*\omega[\text{vowel, round}]$  twice, while the winning

candidate (b) only violates the constraint once. Candidate (d) shows raising enforced by \*[ROUND open], yet this candidate also fatally violates MAXLINK[open].

We can conclude that BDT can account for icy targets in Icelandic words without reduction. Next, I look at forms with reduction.

### Roots with reduction

Recall that in the reduced roots, rounding is complemented by an additional rule that raises unstressed [œ] to [ɣ]. A derived [ɣ] triggers rounding of preceding open vowels. While this fact is unexpected if viewed from a classic representational view, it is predicted under BDT. In particular, the constraint on heads \*[ROUND open] restricts spreading from [œ], but not from [ɣ]. Since \*[ROUND open] is never violated by an [ɣ], rounding can spread to preceding open vowels, as enforced by the alignment constraint \* $\omega$ [vowel, round] which outranks the faithfulness constraint DEPLINK[round].

The forms with reduction are similar to those without reduction in that the constraint on heads outranks the alignment constraint. At the same time, there are also differences among the ranking applying to both types of forms. There are several ways of capturing this situation. One option is to use (partially) different grammars. The model based on cophonologies gives a different ranking of the same constraints across variants (Inkelas et al. 1996, 1997; Inkelas & Zoll 2005, 2007; Anttila 2002).<sup>6</sup> In the forms without reduction as in (100), MAXLINK[open] outranks the alignment constraint \* $\omega$ [vowel, round]. As a consequence, rounding never triggers raising. In contrast, in the forms with reduction like *d[œ]s[ɣ]ð[ɣ]st[ɣ]m* ‘most exhausted.DAT.PL’ in (101) the constraint MAXLINK[open] is ranked below \* $\omega$ [vowel, round]. Consequently, vowels are raised and rounding applies further rightwards. Here I do not attempt to analyze the reduction pattern, which needs a separate account, I merely discuss the constraints already introduced for forms without reduction.

In (101), the winning candidate is (d) since it exhibits reduction in all unstressed vowels and u-umlaut throughout the root, satisfying both \*[ROUND open] and \* $\omega$ [vowel, round]. Other candidates violate one of the high ranked constraints. Candidate (a) shows no spreading, fatally violating \* $\omega$ [vowel, round]. Candidate (b) has non-iterative spreading, but still violates the alignment constraint. Note that candidate (b) with the same pattern wins in tableau (100). The difference between the roots with reduction and those without reduction is in the ranking of MAXLINK[open]. Candidate (c) violates \*[ROUND open] twice, since two open

---

<sup>6</sup>The attested variation is also consistent with an alternative approach based on lexical indexation (Itô & Mester 1995a,b, 1999, 2001, 2003, 2008a; Fukazawa et al. 1998; Pater 2000, 2007, 2009; Flack 2007; Gouskova 2007; Jurgec 2010a). According to this approach, constraints come in two classes—general and morphologically relativized (i.e., indexed).



likewise inhibited. This means that when an icy target segment appears in the input, no spreading occurs.

In Icelandic, the segment affected by the constraint on heads \*[ROUND open] is [œ]. We have seen that if this segment is derived by rounding, the constraint on the head effectively terminates further spreading. I now look at underlying /œ/. The prediction so far is that spreading will not apply.

Underlying /œ/ is limited to a small set of roots. One such example is *m[œ]r* ‘suet’. However, to determine whether /œ/ triggers rounding or not, we need to look for roots containing a preceding /a/. To the best of my knowledge, only one root has such characteristics: [a]m[œ]b[a] ‘amoeba’. We can see that rounding does not spread to the preceding /a/, which is in line with the predictions. More specifically, BDT correctly predicts that an input /œ/ does not trigger u-umlaut, since the constraint against feature heads \*[ROUND open] in (99) applies to all output open vowels (derived or underlying). The remaining point is to demonstrate this effect.

Tableau (102) shows the evaluation for the Icelandic input /amœba/ ‘amoeba’. Candidates without spreading differ in whether they contain a head (a) or not (b). Recall that heads are defined only for binary branching feature nodes, as in (85). That is, when there is a feature node linked to two root nodes, exactly one of these two root nodes is a head. This definition says nothing about features linked to a single root node. This means that we need to allow both structures: one that contains a head and one that does not. Candidate (102-a) contains a head, which is indicated by a capitalized [ROUND]. This candidate fatally violates \*[ROUND open]. Candidate (b), on the other hand, does not contain a head. Candidate (b) also harmonically bounds (a). This is because (a) and (b) differ solely in terms of \*[ROUND open], but fare equally on all other constraints. The constraint \*[ROUND open] prefers those singly associated root nodes that are also headless. Candidate (c) shows deletion of the [round] feature, which fatally violates MAXLINK[round]. Candidate (d) with spreading also violates \*[ROUND open].

The final candidate (e) has an epenthetic [round]. Epenthesis differs from spreading in that no feature heads are involved. Since \*[ROUND open] is not violated in this case, it might be possible that this constraint prefers feature copying rather than spreading. However, as evident from the tableau, the constraint \*[ROUND open] is not able to generate feature epenthesis rather than spreading. This is because the epenthetic candidate (e) additionally violates the alignment constraint. It actually turns out that candidate (e) is harmonically bounded by (b), since it violates DEPLINK[round] and DEP[round] (not shown) in addition to \*ω[vowel, round].

(102) amoeba ‘amoeba’

|                  | $\begin{array}{c} [\text{rd}] \\   \\ / \text{ a } \text{ m } \text{ \ae } \text{ b } \text{ a } / \\   \quad   \quad   \\ [\text{op}] \quad [\text{op}] \quad [\text{op}] \end{array}$                       | MAXLINK[rd] | *[RD op] | * $\omega$ [vow,rd] | DEPLINK[rd] |
|------------------|---------------------------------------------------------------------------------------------------------------------------------------------------------------------------------------------------------------|-------------|----------|---------------------|-------------|
| a.               | $\begin{array}{c} [\text{RD}] \\   \\ \text{ a } \text{ m } \text{ \ae } \text{ b } \text{ a } \\   \quad   \quad   \\ [\text{op}] \quad [\text{op}] \quad [\text{op}] \end{array}$                           |             | *!       | *                   |             |
| b. $\rightarrow$ | $\begin{array}{c} [\text{rd}] \\   \\ \text{ a } \text{ m } \text{ \ae } \text{ b } \text{ a } \\   \quad   \quad   \\ [\text{op}] \quad [\text{op}] \quad [\text{op}] \end{array}$                           |             |          | *                   |             |
| c.               | $\begin{array}{c} \text{ a } \text{ m } \text{ a } \text{ b } \text{ a } \\   \quad   \quad   \quad   \\ [\text{op}] \quad [\text{op}] \quad [\text{op}] \end{array}$                                         | *!          |          |                     |             |
| d.               | $\begin{array}{c} [\text{RD}] \\ / \quad \backslash \\ \text{ a } \text{ m } \text{ \ae } \text{ b } \text{ a } \\   \quad   \quad   \\ [\text{op}] \quad [\text{op}] \quad [\text{op}] \end{array}$          |             | *!       |                     | *           |
| e.               | $\begin{array}{c} [\text{rd}] \quad [\text{rd}] \\   \quad   \\ \text{ a } \text{ m } \text{ \ae } \text{ b } \text{ a } \\   \quad   \quad   \\ [\text{op}] \quad [\text{op}] \quad [\text{op}] \end{array}$ |             |          | *                   | *!          |

Tableau (102) demonstrates that unary domains consisting solely of heads are harmonically bounded and can never surface. This is because candidates with a single head without a dependent violate \*[F g], while the competing candidates without a head do not violate \*[F g] and do not additionally violate any other constraints. In other words, heads cannot surface without branching. Constraints on heads make restrictions on heads. Thus, heads are avoided unless otherwise required.

There is one final consideration. Given Richness of the Base, heads can appear in the input. If so, they must map to some well-formed output. In Icelandic, underlying heads on / $\text{\ae}$ / have no effect on the output. Tableau (103) contains an input containing a headed / $\text{\ae}$ /. In all other respects, the input in (103) is identical to the input in (102). Regardless of whether an input contains a head or not, the same headless candidate (b) wins. This is because the only constraint that refers to heads is a markedness constraint. Since markedness constraints evaluate only the outputs, it does not matter whether heads are present in the input or not. In other words, the evaluations in tableau (103) are identical to the ones in (102), in spite of different inputs.



(103) amoeba ‘amoeba’

|    | [RD]                                                                                                                                                                      |             |          |                     |             |
|----|---------------------------------------------------------------------------------------------------------------------------------------------------------------------------|-------------|----------|---------------------|-------------|
|    | $\begin{array}{c} \text{[RD]} \\ / \text{ a } \text{ m } \text{ œ } \text{ b } \text{ a } / \\ \text{[op]} \quad \text{[op]} \quad \text{[op]} \end{array}$               | MAXLINK[rd] | *[RD op] | * $\omega$ [vow,rd] | DEPLINK[rd] |
| a. | $\begin{array}{c} \text{[RD]} \\ \text{ a } \text{ m } \text{ œ } \text{ b } \text{ a } \\ \text{[op]} \quad \text{[op]} \quad \text{[op]} \end{array}$                   |             | *!       | *                   |             |
| b. | $\begin{array}{c} \text{[rd]} \\ \text{ a } \text{ m } \text{ œ } \text{ b } \text{ a } \\ \text{[op]} \quad \text{[op]} \quad \text{[op]} \end{array}$                   |             |          | *                   |             |
| c. | $\begin{array}{c} \text{ a } \text{ m } \text{ a } \text{ b } \text{ a } \\ \text{[op]} \quad \text{[op]} \quad \text{[op]} \end{array}$                                  | *!          |          |                     |             |
| d. | $\begin{array}{c} \text{[RD]} \\ \text{ a } \text{ m } \text{ œ } \text{ b } \text{ a } \\ \text{[op]} \quad \text{[op]} \quad \text{[op]} \end{array}$                   |             | *!       |                     | *           |
| e. | $\begin{array}{c} \text{[rd]} \quad \text{[rd]} \\ \text{ a } \text{ m } \text{ œ } \text{ b } \text{ a } \\ \text{[op]} \quad \text{[op]} \quad \text{[op]} \end{array}$ |             |          | *                   | *!          |

Underlying heads have another theoretical implication, which has to do with what constraints can refer to feature heads. In particular, constraints on feature heads like \*[ROUND open] suggest that there might be other constraints that also refer to feature heads. Examples include MAXLINK[ROUND], DEPLINK[ROUND] or \* $\omega$ [vowel, ROUND]. As an example, let us consider MAXLINK[ROUND], which preserves input heads of [round]. When MAXLINK[ROUND] outranks all constraints on heads of [round], this creates a grammar in which input heads are preserved, but no additional heads are created. Furthermore, the feature would spread to exactly one target. This is because MAXLINK[ROUND] prohibits deletion of a head on an input vowel, but an output can contain a head only if the feature spreads. As a result, the feature would have to spread at least once to preserve the head. Non-iterative spreading is an attested pattern in tone spreading, which might give support for constraints like MAXLINK[H]. While there might be other patterns that support such constraints, I remain agnostic as to whether they are actually required. Put differently, in the model advocated in this thesis, there will be only one kind of constraint on feature heads—\*[F g]. The inability of all other constraints to refer feature heads is not necessarily an ad hoc restriction on Con. More specifically, the fact that phonological primitives can be referred to by some constraints, does not entail that all constraints must be allowed to refer

to them. To give an example, consider possible constraints containing a mora. Moras are standardly referred to by faithfulness constraints like MAX- $\mu$  and DEP- $\mu$  or markedness constraints like  $^*\mu\mu\mu$  and  $^*\mu[\text{seg}]$  (Morén 1999/2001). Hence, we would also expect a simple markedness constraint  $^*\mu$ . Yet such a constraint would predict many unattested patterns in combination with other constraints and should be either ruled out or universally low ranked. This is directly relevant to the present approach which predicts only one type of constraints on feature heads:  $^*[F\ g]$ . The existence of this constraint does not necessitate any other constraints on feature heads.

This concludes the analysis of u-umlaut in Icelandic. BDT has been shown to account for the absence of any spreading from  $[\text{œ}]$  in a simple, yet quite restrictive fashion.

## 4.4 Sanskrit

So far in this chapter, I introduced the concept of icy targets in Icelandic and gave a representational account of it. In particular, I claimed that feature spreading is maximally binary, hierarchical and recursive. We have seen that Icelandic u-umlaut involves vowel place features. In this section, I extend the account to a case of assimilation that involves a consonant feature. Thus, icy targets are not specific to vowel harmony, but may also be found in other types of assimilation, including consonant harmony.

Much like Icelandic u-umlaut, Nati in Sanskrit has drawn a great deal of attention in the history of Generative Phonology (Johnson 1972; Selkirk 1980a; Kiparsky 1985; Schein & Steriade 1986; Cho 1991; Hall 1997; Ní Chiosáin & Padgett 1997; Gafos 1996/1999; Hansson 2001; Rose & Walker 2004; Kaplan 2008b). Nati involves spreading of retroflexion from coronal continuants to the dental nasal. In this section, I first describe the data (section 4.4.1), followed by an analysis based on constraints on feature heads (section 4.4.2).

### 4.4.1 Data

Nati in Sanskrit is an alternation in which retroflexion spreads within coronals. In particular, a feature responsible for retroflexion spreads from the continuants  $\{r, \text{ʃ}\}$  to the first following  $/n/$ . The resulting retroflex  $[n̠]$  is an icy target, blocking any further spreading.

The coronal inventory of Sanskrit including the relevant features is presented in (104). There are three sets of coronal segments: dental, retroflex and palatal consonants. Within each set, there are four oral stops, one nasal and two contin-

uants. Only continuants can serve as triggers in Nati, and the only target is /n/ which is turned into [ŋ].

(104) Sanskrit coronal inventory (Whitney 1889; Gafos 1996/1999)

|             |   |   |                |   |                |   |       |
|-------------|---|---|----------------|---|----------------|---|-------|
|             | [ | s | t              | o | p              | ] |       |
|             |   | t | t <sup>h</sup> | d | d <sup>h</sup> | n | s l   |
| [retroflex] |   | ṭ | ṭ <sup>h</sup> | ḍ | ḍ <sup>h</sup> | ṇ | ṣ r   |
|             |   | c | c <sup>h</sup> | ç | ç <sup>h</sup> | ɲ | ʃ j   |
|             |   |   |                |   |                |   | [nas] |

The features I will use in what follows are [nasal], [stop] and [retroflex]. While the first is a well-established feature, the other two require some clarification. In this thesis, all plosives (either oral or nasal) have the feature [stop]. In terms of articulation, this feature corresponds to a complete obstruction of airflow in the vocal tract. The final feature, [retroflex], also has a direct articulatory correlate: a tip of the tongue that is curled back. Most other analyses, however, assume that Nati involves spreading of two binary features, [–anterior] and [–distributed] (e.g. Johnson 1972; Schein & Steriade 1986). The challenge of this standard approach is that it requires spreading of the negative value of the feature. However, some features never spread this way. For instance, spreading of [–nasal] and [–round] is not attested (see section 2.2.1 for further discussion). Hence, spreading the feature [retroflex] is a viable alternative to this problem. The feature [retroflex] may be a dependent feature of [coronal], which is in line with most previous accounts (Schein & Steriade 1986; Sagey 1990; Hall 1997; Ní Chiosáin & Padgett 2001; Hansson 2001; Rose & Walker 2004), but the present analysis based on alignment constraints does not require such a restriction. This is further supported by the fact that vowels may also be retroflex. We will see one such example in section 8.5.3.

The data in (105) demonstrate that /n/ alternates with [ŋ] only if preceded by a trigger continuant {r, ṣ}. The alternation applies across vowels and non-coronal consonants (e.g. [kṣub<sup>h</sup>-a:ṇa] ‘quake-MID.PART’) within the same phonological phrase (Selkirk 1980a). The spreading feature affects only coronals. Coronals differ with respect to their role in Nati. Retroflex coronal continuants {r, ṣ} trigger spreading. The nasal dental non-continuant /n/ is the only target. All other coronal non-continuant block the process. For instance, ‘wipe-MID.PART’ surfaces faithfully [marj-a:ṇa], rather than with retroflexion \*[marj-a:ṇa], because [j] interferes with spreading. Palatal coronals cannot become retroflex.

|       |                                                         |                   |                      |                    |
|-------|---------------------------------------------------------|-------------------|----------------------|--------------------|
| (105) | Nati (Whitney 1889; Allen 1951; Schein & Steriade 1986) |                   |                      |                    |
|       | With Nati                                               |                   | No Nati              |                    |
|       | iṣ-ṇa:                                                  | ‘seek-PRES’       | mṛd-na:              | ‘be gracious-PRES’ |
|       | pṛ-ṇa:                                                  | ‘fill-PRES’       |                      |                    |
|       | puṛ-ṇa                                                  | ‘fill-PAS.PART’   | b <sup>h</sup> ug-na | ‘bend-PAS.PART’    |
|       | vṛk-ṇa                                                  | ‘cut up-PAS.PART’ |                      |                    |
|       | pur-a:ṇa                                                | ‘fill-MID.PART’   | kṣved-a:na           | ‘hum-MID.PART’     |
|       | kṣub <sup>h</sup> -a:ṇa                                 | ‘quake.MID.PART’  | marj-a:na            | ‘wipe-MID.PART’    |
|       | caḥṣ-a:ṇa                                               | ‘see-MID.PART’    |                      |                    |
|       | kṛp-a-ma:ṇa                                             | ‘lament-MID.PART’ | kṛt-a-ma:na          | ‘cut-MID.PART’     |

The icy target pattern becomes apparent when more than one /n/ follows a retroflex coronal continuant, as in (106). For example, in [varṇ-ana:nam] ‘description-MID.PART-GEN.PL’ only the first coronal nasal is retroflex, while the rest remain unaffected. This reveals that [ṇ] is an icy target: retroflexion spreads to [ṇ], but cannot be spread beyond the derived [ṇ]. In other words, while all three segments {r, ṣ, ṇ} can be associated with the feature [retroflex], only {r, ṣ} can be the triggers. The Nati pattern found in coronals resembles the u-umlauting pattern found in vowels in Icelandic. While [ṇ] is a consonant, and [œ] is a vowel, they are both icy: they are targets of a feature spreading process, but block spreading at the same time.

|       |                                          |                    |              |                               |
|-------|------------------------------------------|--------------------|--------------|-------------------------------|
| (106) | Icy targets (Whitney 1889; Hansson 2001) |                    |              |                               |
|       | With Nati                                |                    | No Nati      |                               |
|       | pra-ṇi-na:ja                             | ‘lead forth’       | ṇi:          | ‘lead’                        |
|       |                                          |                    | kṛṇ-va:na    | ‘make-MIDDLE.PART’            |
|       | tvar-aṇa:                                | ‘hasting-MID.PART’ | varṇ-ana:nam | ‘description-MID.PART-GEN.PL’ |

With the data reviewed, I now move on to the analysis. The analysis combines the mechanism of BDT developed for Icelandic u-umlaut, and extends it to Sanskrit retroflex harmony.

#### 4.4.2 Analysis

I analyze Nati as spreading of the feature [retroflex]. This feature is unlike any of the vowel place features discussed so far. Other place features prefer spreading to vowels rather than consonants. Retroflexion does not seem to exhibit the same characteristics. In particular, we know of languages that spread retroflexion from one coronal to another across vowels—such as Sanskrit and Kinyarwanda (Walker et al. 2008). Furthermore, we also know languages in which retroflexion spreads from one vowel to another across non-coronals—as in some dialects of Kalasha (Heegård & Mørch 2004, see section 8.5.3 for further discussion). How-

ever, we know of no languages in which retroflexion spreads from any segment across (non-retroflex) coronals. This suggests that the feature [retroflex] prefers coronal consonants to other segments. In the present context, such a preference can be captured with alignment constraints. The alignment constraint preferring spreading of [retroflex] may contain [coronal] as the targeted structure, but likely not other features. In Sanskrit, the alignment constraint has [retroflex] as the spreading feature and [coronal] as the targeted structure, as in (107). The domain is a phonological phrase (Selkirk 1980a).

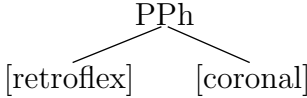
- (107) \*PPh[retroflex, coronal]
- a. \*⟨PPh, [retroflex], [coronal]⟩ / 
- b. Assign a violation mark for every triplet ⟨PPh, [retroflex], [coronal]⟩, iff
- PPh is associated with [retroflex] and [coronal]  
and  
[retroflex] ≺ [coronal].

Spreading of [retroflex] is preferred when \*PPh[retroflex, coronal] (107) outranks the faithfulness constraint DEPLINK[retroflex]. This, however, is not the complete story. Recall that retroflexion shows a restrictive pattern, in which only continuants can act as triggers. Furthermore, derived retroflex nasals terminate further retroflexion and act as icy targets. The restrictions on icy targets are formalized in terms of markedness constraints on feature heads. In Nati, nasals pattern with oral stops. This strongly suggests that the relevant constraint penalizes feature heads of [retroflex] on plosives (which can be either oral or nasal). This constraint, \*[RETROFLEX stop] (108), outranks the alignment constraint. Keep in mind that constraints on heads do not have a directional value. Hence, they are equally violated by a left-headed domain as in (108-b), or a mirror-image right-headed domain.

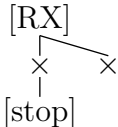
- (108) \*[RETROFLEX stop]
- a. Assign a violation mark for every root node ×, iff × is a Head of the feature [retroflex] and × is associated with [stop].
- b. \* 

The effects of the constraint on heads \*[RETROFLEX stop] can be seen in tableau (109). Three candidates are shown. Candidate (a) has no spreading, candidate

(b) has an icy target, while candidate (c) has total spreading. Candidate (c) contains two heads of [retroflex] on [ŋ], and thus crucially violates \*[RETROFLEX stop]. The winning candidate (b) violates the next highest constraint \*Φ[retroflex, coronal] one fewer time than candidate (a).

(109) vaṛṇana:na:m ‘description.GEN.PL’

|                                                                                      |                                                                                                                                                                                                                                                                                                |  |  |              |
|--------------------------------------------------------------------------------------|------------------------------------------------------------------------------------------------------------------------------------------------------------------------------------------------------------------------------------------------------------------------------------------------|--|--|--------------|
|                                                                                      | $\begin{array}{c} \text{[rx]} \\   \\ / \text{ v a } \text{r} \text{ n - a n a: - n a: m } / \\   \quad   \quad   \quad   \\ \text{[c]} \text{[c]} \quad \text{[c]} \quad \text{[c]} \end{array}$                                                                                              |  |  |              |
| a.                                                                                   | $\begin{array}{c} \text{[rx]} \\   \\ \text{v a } \text{r} \text{ n a n a: n a: m} \\   \quad   \quad   \quad   \\ \text{[c]} \text{[c]} \quad \text{[c]} \quad \text{[c]} \end{array}$                                                                                                        |  |  | ***!         |
| b.  | $\begin{array}{c} \text{[RX]} \\   \quad \diagdown \\ \text{v a } \text{r} \quad \text{ṅ} \text{ a n a: n a: m} \\   \quad   \quad   \quad   \\ \text{[c]} \text{[c]} \quad \text{[c]} \quad \text{[c]} \end{array}$                                                                           |  |  | **      *    |
| c.                                                                                   | $\begin{array}{c} \text{[RX]} \\   \quad \diagdown \quad \diagdown \\ \text{v a } \text{r} \quad \text{ṅ} \quad \text{R X} \quad \text{ṅ} \quad \text{a: n a: m} \\   \quad   \quad   \quad   \quad   \\ \text{[c]} \text{[c]} \quad \text{[c]} \quad \text{[c]} \quad \text{[c]} \end{array}$ |  |  | *!*      *** |

Before I conclude the analysis of Nati, I will comment on two remaining issues. First, as we have seen in the previous section, only anterior coronals undergo the pattern. Palatal coronals cannot become retroflex, which can be attributed to a general incompatibility of palatals and retroflexion (Hamann 2003; Hall & Hamann 2010). A standard account of such an incompatibility are feature co-occurrence constraints. I will take on this approach in chapter 6. Second, of all anterior coronal non-continuants in Sanskrit, only the nasal is affected. Oral stops are not subject to Nati. This resembles the situation in Icelandic, where only /a/ is subject to rounding and fronting. One way to account for this is by ranking the feature co-occurrence constraints against oral retroflex stops above the alignment constraint, but below MAXLINK[retroflex]. This results in a pattern in which underlying oral retroflex stops are possible, but they cannot be derived by the Nati rule. Feature co-occurrence constraints are further discussed in section 6.2.1, where it will be shown that they enforce blocking. This can be supported by the Nati pattern in which oral coronals block retroflexion. Another way of analyzing this pattern is to say that the triggers and the targets must agree in terms of another feature. This

approach is taken on in chapter 8, where parasitic vowel harmony and consonant harmony are discussed.

This concludes the analysis of Nati. In this chapter, I argue for a theory of autosegmental spreading with headed binary domains. We have seen that evidence for BDT can be extended to consonant harmony. The question is whether Nati constitutes a genuine case of consonant harmony. Hansson (2001) and Rose & Walker (2004) observe that Nati is anomalous with respect to other consonant harmonies in two respects. First, other harmonies do not have restrictions on triggers. Second, the triggers {ʃ, r} and the target [ŋ] do not form a natural class to the exclusion of all other segments. I addressed the first point, and accounted for it by a simple modification of feature spreading. That is, consonant harmony in Nati exhibits icy targets. This makes the pattern directly parallel to vowel harmony in Icelandic (section 4.3) and nasal harmony in Ikwere (section 4.5). I will revisit the second point in sections 8.5 and 9.4.1.

In this section, I extended the phenomenon of icy targets to consonant harmony. The analysis is based on the ideas developed so far, but requires two minimal modifications. First, we have seen alignment constraints work for strictly local patterns (nasal harmony, emphasis spread) and vowel harmony. In RTR spreading, for example, alignment constraints may contain vowels or a subset of vowels as targeted structures. This differs from consonant harmony. In retroflexion, alignment constraints contain coronals as the targeted structure. There are two reasons for such a decision. First, retroflexion is limited to coronal consonants and vowels, which has to do with its articulatory correlates. Second, there is no known case in which retroflexion spreads from one vowel to another across a coronal. In short, the present account based on alignment constraints and BDT allows a unified account of u-umlaut and Nati.

## 4.5 Ikwere

Up to this point, I presented two cases of icy targets. Icelandic u-umlaut is a case of vowel harmony, while Nati is a case of consonant harmony. Both processes are specific to one class of triggers and targets (open vowels, coronals), to the exclusion of all other segments. Nasal harmony is a third type of process, in which the trigger and potential targets generally constitute an uninterrupted domain consisting of a string of strictly adjacent segments. An example of nasal harmony is Applecross (section 2.2.2). In this section, I look at icy targets in nasal harmony. In particular, I describe the icy target pattern in Ikwere nasal harmony. The Ikwere pattern differs in another way from Icelandic u-umlaut and Nati. Ikwere has bidirectional nasal harmony, which displays an asymmetry: icy targets are attested only in leftward spreading, but not in rightward spreading. I will argue





- b. Sonorants undergo harmony
- |       |               |
|-------|---------------|
| ɔbãrã | ‘blood’       |
| mõỹõ  | ‘urine’       |
| ekãrã | ‘strong odor’ |
- c. Morphologically complex forms
- |                       |                        |
|-----------------------|------------------------|
| o kē-g <sup>w</sup> u | ‘s/he is holding’      |
| (ɔ) bya-rʊ (nũ ekile) | ‘s/he came yesterday’  |
| (ɔ) wĩ-rũ (mãỹã)      | ‘s/he drank some wine’ |
| (ɔ) bã-ỹã-nēm         | ‘she has come in’      |
| (o) ri-lem            | ‘s/he has eaten’       |

The nasal harmony pattern is additionally restricted. All attested outputs contain maximally one string of nasal segments per morpheme. There are no outputs that contain more than one string of nasal segments (e.g. \*[bĩsĩ] ‘poison’). The absence of these forms suggests that only one instance of [nasal] per morpheme is allowed. While this is a significant fact, I will not attempt to account for it at this point. This is because this appears to be a case of dissimilation in the sense that only one instance of a feature is allowed per morpheme. Dissimilation is analyzed in sections 3.3.2 and 9.4.3.

The generalizations based on static patterns are supported by alternations in which nasality spreads to suffixes (111-c). Ikwere also exhibits two types vowel harmony (tongue root and front/back), but they are not relevant to nasal harmony. While Clements & Osu (2005) do include tones in their transcriptions, tones are omitted in the transcriptions henceforth.

The descriptive generalizations regarding the general nasal harmony pattern can be made clear by examining the gaps. In (112), I consider a hypothetical string /karawaka/. As pointed out above, any sequence of nasal segments is always contiguous within a morpheme. This suggests that we need to consider at most five inputs for the a segmental string /karawaka/ (nasality omitted). One of them contains no input nasal segments. The remaining four have exactly one input nasal vowel, and these will now be discussed in detail. First, let us look at an input with an underlying final nasal vowel /karawakã/ (112-a). This input must surface faithfully, because the preceding stop blocks nasal harmony. Next is an input that contains a nasal vowel in the third syllable /karawãka/ (112-b). We expect regressive nasalization until blocked by the initial stop. All other mappings are unattested. For example, the unattested form in (112-bb) shows that there are no forms like \*[karawãka], which would show a blocking sonorant consonant in the left direction.

## (112) Gaps in forms without nasal sonorant stops

|     | INPUT      | ATTESTED   | UNATTESTED             | COMMENT              | DIR   |
|-----|------------|------------|------------------------|----------------------|-------|
| a.  | /karawakã/ | [karawakã] | *kãrãwãkã              | stop must block      | left  |
| ba. | /karawãka/ | [kãrãwãka] | *karawãka              | vowel must trigger   | left  |
| bb. |            |            | *karawãka              | sonorant not blocker | left  |
| bc. |            |            | *kara $\tilde{w}$ ãka  | not icy target       | left  |
| bd. |            |            | *kara. $\tilde{w}$ ãka | domain not syllable  | left  |
| be. |            |            | *kara $\tilde{w}$ ãka  | vowel not blocker    | left  |
| bf. |            |            | *kãrãwãka              | not icy target       | left  |
| bg. |            |            | *kãrãwãkã              | stop must block      | right |
| ca. | /kãrãwaka/ | [kãrãwãka] | *kãrãwaka              | vowel must trigger   | right |
| cb. |            |            | *kãrã.waka             | domain not syllable  | right |
| cc. |            |            | *kãrãwaka              | sonorant not blocker | right |
| cd. |            |            | *kãrã $\tilde{w}$ aka  | not icy target       | right |
| ce. |            |            | *kãrãwãka              | vowel not blocker    | right |
| d.  | /kãrawaka/ | [kãrãwãka] | *kãrãwaka              | not icy target       | right |

Once we consider all possible mappings in (112), it becomes clear that nasal vowels always trigger nasal harmony in both directions, while oral vowels are undergoers. All sonorants are regular targets (and are never blockers or icy targets). Stops always block harmony. Finally, the domain of nasal harmony is larger than the syllable, since there are no forms like \*[kara. $\tilde{w}$ ãka] (112-bd) or \*[kãrã.waka] (112-cb) in which nasality fails to spread across the syllable boundary containing a trigger. A summary of these findings is in (113).

## (113) Summary of Ikwere nasal harmony (applies in both directions)

| SEGMENT     | ROLE    |
|-------------|---------|
| Nasal vowel | Trigger |
| Oral vowel  | Target  |
| Sonorant    | Target  |
| Stop        | Blocker |

Now that we have fully examined the behavior of sonorants and stops, we can move to the remaining segments. Nasal sonorant stops {m, 'm, n} differ from other non-obstruents. The coronal sonorant stop [n] alternates with the coronal lateral [l], while bilabial sonorant stops {m, 'm} alternate with bilabial non-explosive stops {b, 'b} (cf. [b̥ekej] 'white man', [ɔk<sup>w</sup>ũ] 'palm nut' vs. [ak<sup>w</sup>ũ-mẽkej] 'coconut'). Non-explosive stops are cross-linguistically rare. Clements & Osu (2002, 2003) show that the articulation of non-explosive stops exhibits no build-up of oral air pressure during occlusion and no audible explosion at release. This leads them to conclude that non-explosive stops are not proper plosives. While this poses a

significant challenge for most feature theories, it is ultimately beyond the scope of this section, which is to account for icy targets.

Nasal sonorant stops {m, 'm, n} exhibit asymmetrical behavior. On the one hand, {m, 'm, n} are undergoers in rightward spreading (114-a). The form 'sibship', for example, shows only nasal segments [wě̃nē̃]. Here I assume that [nasal] comes from the first vowel in the input /wēle/, such that the nasal sonorant stop [n] is an undergoer. This is further supported by the absence of forms with an icy target [n], \*[wē̃ne], or a blocking [l], \*[wēle]. In some forms {b, 'b, l} overtly alternate with {m, 'm, n} (cf. [(o) ri-lem] 's/he has eaten' vs. [(ɔ) w̃ɔ-nēm] 's/he has drunk'). In short, the data suggest that nasal sonorant stops are targets in rightward spreading.

(114) Nasal sonorant stops

- |    |                                                      |                         |
|----|------------------------------------------------------|-------------------------|
| a. | Targets in rightward spreading                       |                         |
|    | wě̃nē̃                                               | 'sibship'               |
|    | mmĩnĩmĩ                                              | 'species of tree'       |
|    | ɔmĩrĩmã                                              | 'meat, flesh'           |
|    | (ɔ) w̃ɔ-nēm                                          | 's/he has drunk'        |
|    | (o) ri-lem                                           | 's/he has eaten'        |
| b. | Icy targets in leftward spreading (some speakers)    |                         |
|    | kmã                                                  | 'now'                   |
|    | ibmē̃                                                | 'type of fruit'         |
|    | akamũ                                                | 'pap'                   |
|    | og <sup>w</sup> umãgala                              | 'chameleon'             |
| c. | Targets in leftward spreading (some speakers)        |                         |
|    | kĩnã                                                 | 'now'                   |
|    | ibĩmē̃                                               | 'type of fruit'         |
|    | akãmũ                                                | 'pap'                   |
|    | og <sup>w</sup> ũmãgala                              | 'chameleon'             |
| d. | Underlying word-final nasals do not spread leftwards |                         |
|    | sakam                                                | 'ray'                   |
|    | odum                                                 | 'lion'                  |
|    | eze-m                                                | 'my health'             |
|    | m zē-g <sup>w</sup> u-m ɔbakiri                      | 'I'm going to Ogbakiri' |

On the other hand, {m, 'm, n} are icy targets in leftward spreading (114-b). The feature [nasal] spreads from a vowel to preceding {b, 'b, l}, which map to {m, 'm, n}, but then block further spreading. The form [kmã] 'now', for example, shows a nasal sonorant stop [n], which is not preceded by a nasal vowel. This crucially contrasts with the form with rightward spreading [wě̃nē̃] 'sibship'. The difference between the two forms suggests that nasality in [kmã] spreads from the final vowel,

while nasality in [w̃ɛnɛ̃] spreads from the first vowel. In other words, /kɪlã/ maps to [kɪnã], whereas /wẽle/ maps to [wẽnẽ]. Thus, the nasal sonorant stop [n] is an icy target in leftward spreading, but a regular target in rightward spreading.

This disparity in directionality is further corroborated by two other facts. First, some speakers treat nasal sonorant stops as (regular) targets in both directions (114-c). For these speakers, there is no real difference between nasal sonorant stops in ‘now’ and ‘sibship’. In both cases, nasal sonorant stops are regular targets. That is, /kɪlã/ maps to [kɪnã], whereas /wẽle/ maps to [wẽnẽ]. While these variants inform the analysis in terms of what are the underlying representations and what is the distribution of nasals. Second, underlying word-final nasal sonorant stops do not spread nasality leftwards, as shown in (114-d). Thus, when icy target segments {m, 'm, n} are underlying, they show no leftward spreading. When nasal sonorant stops are non-final, they spread nasality rightwards. This again supports the claim that nasals are icy targets in leftward spreading (i.e., they do not trigger spreading and terminate it, but are targets at the same time), but regular targets in rightward spreading.

The icy target pattern is rather complicated, but can be verified by gaps in a manner similar to the behavior of other segments. In (115), I consider a hypothetical string /telele/, in which exactly one vowel is nasal, yielding three possible inputs. The interest of the current discussion is the status of the segmental pair {l, n}. The lateral [l] can be a blocker in either direction, while [n] can be either a target or an icy target. Given that these variables are direction-specific, there is a total nine possible mappings. For example, (115-a) presents a situation in which [n] is a target in both directions. In this case, all three inputs map to a single output. This output, [tɛnɛ̃nɛ̃], is actually attested in the language. The problem is that it does not reflect the actual data, in which each of the three inputs maps to a *different* output. One can similarly examine all other combinations. The only situation consistent with the data is (115-h), in which [n] is an icy target in leftward nasal harmony, but a regular target in rightward nasal harmony. The findings can be generalized to any sonorant nasal stop.

An alternative solution why nasal harmony terminates at a nasal sonorant stop would be to say that spreading applies within a syllable. However, we have already seen in (112) that nasal harmony applies beyond the syllable boundary of the triggering vowel when the target is a sonorant. Hence, it seems unlikely that nasal harmony is limited to the same syllable only when the target is a nasal sonorant stop, but not otherwise. Even if we entertain such an option, it is not clear how to model it. Additional support against this alternative comes from forms with final nasals, such as [eze-m] ‘my health’ and other forms in (114-d). In these examples, the nasal sonorant stop is in the coda. What this indicates is that the alternative based on a syllable boundary (but only when nasal sonorant stops

are targets) should be rejected over a more parsimonious hypothesis, namely that icy targets are involved.

(115) Gaps: A hypothetical example /telele/

|    | Direction             |            | Inputs         |                |                | Consistent<br>with<br>the data? |
|----|-----------------------|------------|----------------|----------------|----------------|---------------------------------|
|    | Left                  | Right      | Option 1       | Option 2       | Option 3       |                                 |
|    | <i>l ~ n</i> is a ... |            | /t̥elele/      | /tel̥ele/      | /telel̥e/      |                                 |
| a. | target                | target     | [t̥ɛ̃ñɛ̃ñɛ̃] | [t̥ɛ̃ñɛ̃ñɛ̃] | [t̥ɛ̃ñɛ̃ñɛ̃] | no                              |
| b. | blocker               | blocker    | *[t̥ɛ̃lele]    | *[tel̥ɛ̃le]    | *[telel̥ɛ̃]    | no                              |
| c. | icy target            | icy target | *[t̥ɛ̃nele]    | *[teñɛ̃ne]    | [tɛ̃nɛ̃nɛ̃]    | no                              |
| d. | target                | blocker    | *[t̥ɛ̃lele]    | *[t̥ɛ̃ñɛ̃le]  | [t̥ɛ̃ñɛ̃ñɛ̃] | no                              |
| e. | target                | icy target | *[t̥ɛ̃nele]    | *[t̥ɛ̃ñɛ̃ne]  | [t̥ɛ̃ñɛ̃ñɛ̃] | no                              |
| f. | blocker               | target     | [t̥ɛ̃ñɛ̃ñɛ̃] | *[tel̃ɛ̃ñɛ̃]  | *[telel̃ɛ̃]    | no                              |
| g. | blocker               | icy target | *[t̥ɛ̃lele]    | *[tel̃ɛ̃ne]    | *[telel̃ɛ̃]    | no                              |
| h. | icy target            | target     | [t̥ɛ̃ñɛ̃ñɛ̃] | [teñɛ̃ñɛ̃]   | [tɛ̃nɛ̃nɛ̃]    | <b>YES</b>                      |
| i. | icy target            | blocker    | *[t̥ɛ̃lele]    | *[teñɛ̃le]    | [tɛ̃nɛ̃nɛ̃]    | no                              |

We have now established that {m, 'm, n} are icy targets in leftward nasal harmony, but regular targets rightward nasal harmony. I now proceed to the analysis.

## 4.5.2 Analysis

I analyze Ikwere nasal harmony in three steps. First, I account for icy targets by introducing the relevant constraint on heads. Second, I discuss alignment constraints. Finally, I present the ranking of these constraints.

Recall section 4.2.4 and the fact that icy targets surface due to the constraints on feature heads \*[F g]. Icy targets in Ikwere are nasal sonorant stops {m, 'm, n}. These three segments display a unique property compared to all other segments of Ikwere: they can be associated with [nasal], but terminate further spreading of [nasal]. The features common to nasal obstruent stops are [nasal] and [stop]. The constraint \*[NASAL stop] in (116) penalizes plosives which are heads of the [nasal] feature. Nasal sonorant stops {m, 'm, n} violate this constraint if they spread [nasal]. Other non-obstruents are all continuants, and satisfy this constraint. Oral stops satisfy this constraint vacuously, since they cannot be associated with the feature [nasal] and block spreading (but I will postpone an analysis of blocking until chapter 6). Note that the constraint on heads does not contain a directional variable and is equally violated by leftward or rightward spreading of [nasal]. In other words, the representation in (116-b) represents only one configuration in which the constraint is violated, while a directional mirror variant is omitted.

(116) \*[NASAL stop]

a. Assign a violation mark for every root node  $\times$ , iff  $\times$  is a Head of the feature [nasal] and  $\times$  is associated with [stop].

b. \* [NAS]

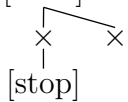

Now I turn to alignment constraints that trigger nasal harmony. As we have seen in the previous section, Ikwere nasal harmony applies in both directions. Several bidirectional assimilation patterns have already been discussed. For instance, Twi (43) has root-controlled [RTR] harmony which spreads to prefixes and suffixes. Bidirectional spreading is well attested, which makes it comparable to unidirectional spreading. If so, do grammars contain three directional variables (leftward, rightward, bidirectional) rather than just two (rightward, leftward)?

Let us consider the first option and treat bidirectional spreading as separate from unidirectional spreading. Such a grammar would contain three types of spreading. Bidirectional spreading would be comparable to leftward and rightward spreading, except that it applies in both directions. When we look at an assimilation pattern that applies in one direction, we see that it treats all identical segments the same way. Some segments are targets, others are icy targets, transparent or blockers. As pointed out by McCarthy (2009), bidirectional assimilation is comparable to unidirectional spreading if it also does not make any distinctions between identical segments. However, because bidirectional processes apply in both directions, this has an additional implication. In particular, if a segment is a blocker or a transparent segment in the left direction, the same segment should also be a blocker or transparent in the right direction. The prediction of the three-way distinction in directionality then seems to be that no language should have segments that block spreading in one direction, but not in the other. The same goes to domain edges: if bidirectional spreading stops at the right edge of some domain, it also cannot apply across the left edge of the same domain.

It turns out that this prediction is incorrect. Several languages exhibit directionality disparities in feature spreading. For example, emphasis spread in Southern Palestinian Arabic is unbounded within a prosodic word but only leftwards, as in (39). In the opposite direction, emphasis is blocked by coronals {i, j, ʃ, ʒ}, which will be further analyzed in section 6.3. Furthermore, Applecross (5) and Epena (14) show nasal spreading unboundedly rightwards, but only within the same syllable leftwards. Somali (15) has vowel harmony in which [atr] spreads leftwards within an intonational phrase, but spreads rightwards at most to the following clitic. Another example comes from Vata, where [atr] spreads from roots to suffixes. In the opposite direction, [atr] spreads optionally across word boundaries,

but only to the root-final vowels (Kaye 1982). These languages show bidirectional spreading with different behavior in one direction compared to the other. This suggests that bidirectional spreading is not a third directional variable. Instead, bidirectional spreading is a combination of two processes, one applying leftwards and the other rightwards. This is entirely consistent with a more parsimonious approach which distinguishes only two directional variables. The current approach captures the distinction between the two directions by specifying f-precedence between a spreading feature and a targeted structure.

Ikwere also shows bidirectional spreading, which can be accounted for by using two separate alignment constraints that differ solely in their f-precedence relations. The first one targets segments to the left, while the second one targets segments to the right. Both constraints have [nasal] as the spreading feature. The domain of the two constraints is a phonological word, which includes the phonological root and all suffixes (for details see Clements & Osu 2005). The remaining variable is the targeted structure. As we have seen above, obstruents do not participate in this alternation and block spreading. One option, then, would be that the targeted structure is [sonorant]. However, the choice of the targeted structure depends not only on what segments are actually targeted, but also on what segments are transparent. If obstruents were transparent, we could conclusively choose [sonorant] as the targeted structure. However, this is not the case. No segment is transparent in Ikwere nasal harmony. This means that there is no way of telling what structure is being targeted in Ikwere. The fact that obstruents block spreading is not very informative, since blocking needs a separate account, while transparency follows directly from alignment constraints. More explicitly, the targeted structure of an alignment constraint specifies targets, whereas the faithfulness constraint  $\text{DEPLINK}[f]$  prefers skipping of transparent segments; blocking by segments cannot be enforced by these two constraints alone. The difference between transparency and blocking will be further discussed in section 6.4. We can conclude that no segment needs to be specifically excluded from spreading, and the targeted structure is a root node. The two constraints are in (117).

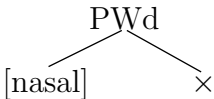
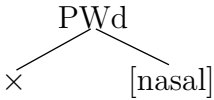
- (117) a.  $*\text{PWd}[\text{nasal}, \times]$   
 $*\langle \text{PWd}, [\text{nasal}], \times \rangle$  / 
- b.  $*\text{PWd}[\times, \text{nasal}]$   
 $*\langle \text{PWd}, [\text{nasal}], \times \rangle$  / 

Both alignment constraints outrank the faithfulness constraint  $\text{DEPLINK}[\text{nasal}]$ . The remaining issue is the ranking of the two alignment constraints with respect

to each other. This is where the constraint \*[NASAL stop] (116) comes into play. This constraint prefers icy targets to regular targets. However, icy targets surface only in leftward spreading, while they are regular targets in rightward spreading. This suggests that the two alignment constraints need to be ranked differently with respect to the constraint on heads. Icy targets surface in leftward spreading, which indicates that the constraint penalizing spreading from icy targets \*[NASAL stop] outranks the spreading constraint \* $\omega$ [ $\times$ , nasal]. On the other hand, rightward spreading shows no icy targets, which suggests that \* $\omega$ [nasal,  $\times$ ] outranks \*[NASAL stop].

The ranking is shown in tableau (118). The input /*ɛkɪlɪɓa*/ ‘plantain’ contains a nasal vowel, which acts as a trigger of nasal harmony. Candidate (a) shows no spreading and fatally violates \* $\omega$ [nasal,  $\times$ ]. Candidate (b) shows spreading to two adjacent icy targets. This candidate, too, fatally violates \* $\omega$ [nasal,  $\times$ ]. The winning candidate (c) satisfies \* $\omega$ [nasal,  $\times$ ], but incurs a violation of \*[NASAL stop]. Candidate (d) shows nasalization which is blocked by an obstruent. This candidate incurs two violations of \*[NASAL stop], once for each nasal sonorant stop. The second violation is fatal, even though this candidate satisfies the alignment constraints best. A theoretically possible candidate (e) is phonetically identical to (d). In terms of association lines, this candidate shows spreading across and to an icy target. Because the leftmost nasal sonorant stop is not a head of the feature [nasal], it does not incur a violation mark of \*[NASAL stop]. I will further discuss this candidate shortly. More specifically, I will argue that this candidate is excluded by Gen (and marked with a biohazard sign ‘☠’ in the tableau below).<sup>8</sup>

---

<sup>8</sup>I leave out constraints preferring blocking on [k]. Blocking is given a full account in chapter 6.



(118)  $\varepsilon k m \tilde{m} \tilde{a}$  ‘plantain’

|                  | $\begin{array}{c} [n] \\ \downarrow \\ \varepsilon \ k \ i \ l \ \dot{i} \ \dot{b} \ a \end{array} /$                         | $*\omega[nas, \times]$ | $*[NAS \ stop]$ | $*\omega[\times, nas]$    | DEPLINK[nas] |
|------------------|-------------------------------------------------------------------------------------------------------------------------------|------------------------|-----------------|---------------------------|--------------|
| a.               | $\begin{array}{c} [n] \\ \downarrow \\ \varepsilon \ k \ i \ l \ \dot{i} \ \dot{b} \ a \end{array}$                           | $\dot{b}! \ a$         |                 | $\varepsilon \ k \ i \ l$ |              |
| b.               | $\begin{array}{c} [N] \\ \swarrow \downarrow \searrow \\ \varepsilon \ k \ i \ n \ \dot{i} \ m \ a \end{array}$               | $a!$                   |                 | $\varepsilon \ k \ i$     | **           |
| c. $\Rightarrow$ | $\begin{array}{c} [N] \\ \swarrow \downarrow \searrow \\ \varepsilon \ k \ i \ n \ \dot{i} \ m \ \tilde{a} \end{array}$       |                        | $m$             | $\varepsilon \ k \ i$     | ***          |
| d.               | $\begin{array}{c} [N] \\ \swarrow \downarrow \searrow \\ \varepsilon \ k \ \dot{i} \ n \ \dot{i} \ m \ \tilde{a} \end{array}$ |                        | $n \ m!$        | $\varepsilon \ k$         | ****         |
| e. $\otimes$     | $\begin{array}{c} [N] \\ \swarrow \downarrow \searrow \\ \varepsilon \ k \ \dot{i} \ n \ \dot{i} \ m \ \tilde{a} \end{array}$ |                        | $(n)$           | $(\varepsilon \ k)$       | (****)       |

Note that candidates (b-e) contain a feature node that has seemingly ternary branching. At first, this appears to be contrary to Strict Binariness (84), which says that all branching is maximally binary. However, recall the claim that bidirectional spreading is a combination of two separate spreading processes: one applying leftwards and the other rightwards. This means that each of the two processes requires their own head to initiate spreading in the first place. In other words, the highest head in the representations of candidates (b-e) actually represents two heads rather than one, although it is graphically represented only by one. The situation can be made more clear by looking at two possible ways in which bidirectional spreading may be represented. In (119), we see the representation of the winning candidate (118-c). The first representation (which will be used throughout this thesis by convention) shows two heads one over the other. The second representation shows a recursive head feature node on the trigger. Such a node is created so that spreading could be bidirectional, while maintaining the Strict Binariness (84) restriction. Two-headed segments are restricted to triggers of bidirectional spreading (when spreading has applied in both directions). If speech actually had three temporal relations or dimensions, we would expect three-headed segments. Two-headed segments are otherwise possible, but such candidates will be harmonically bounded to single-headed segments, since there is no constraint that prefers two-headed targets (or triggers of unidirectional assimilation) to single-headed ones.

(119) Two notational variants of the winning candidate (118-c) [ɛkmĩmã]



With the concerns regarding bidirectional assimilation in mind, we can now proceed to the analysis of candidate (118-e). This candidate shows assimilation both across and to an icy target. This situation does not incur a violation mark of any constraint on heads, including \*[NASAL stop]. The existence of such candidates is a serious challenge for the approach advocated in this chapter, since spreading over and to an icy target will always be preferred to spreading only to an icy target. In other words, the candidates like (118-e) will always win over candidates like (118-c). The solution to this challenge is to universally exclude such candidates. In the language of OT, candidates like (118-e) will never be produced by Gen. The question is whether such a restriction is only stipulative or it follows from some other principle of BDT. Recall the discussion in section 4.2 and the fact that the current proposal stems from an idea that prosody and assimilation are more similar than previously assumed. One of the similarity between both phenomena is that they exhibit difference in terms of prominence, which is formalized as headedness. However, there are also crucial differences between the two phenomena. In particular, prosody typically forms non-overlapping/non-recursive binary units. Feature spreading, on the other hand, does. There are no cases of feature spreading involving a rhythmic skipping of every other target. This observation can be extended to heads. Features cannot spread such that heads would be created on every other target. In short, heads cannot lapse. Instead, any segment that is associated with a feature and both preceded and followed by a target, must be a head of that feature, as defined in (120). In the following chapter, we will see that this restriction can be extended to transparent segments. In particular, what I will argue is that assimilation is strictly local, such that no segment can be skipped (which includes both association and headedness).

(120) No Head Lapse

Let  $\times_i < \times_j < \times_k$ .

If  $\times_i, \times_j, \times_k$  are associated with the same autosegment [f], then  $\times_j$  must be a Head of that [f].

We can conclude that No Head Lapse follows from the general locality restrictions on assimilation. Candidates with skipped heads are excluded by Gen and cannot surface.

We have now resolved the two remaining issues regarding the distribution of feature heads, and we can return to Ikwere. In this section, we have seen that

Ikwere shows icy targets with a particular twist. Nasals are icy targets in leftward spreading, but (regular) targets in rightward spreading. These differences in directionality are predicted by an approach based on alignment constraints. Two alignment constraints that differ solely in directionality are ranked differently. One alignment constraint outranks the constraint on feature heads which enforces icy targets, while the other alignment constraint is outranked by the constraint on feature heads.

Ikwere nasal harmony complements the two other cases of icy targets found in Icelandic u-umlaut and Sanskrit Nati retroflexion. First, all three feature spreading processes can be analyzed using the alignment template introduced in section 2.2.2. The alignment constraint in nasal harmony is violated by any segment. The alignment constraints in other harmonies, on the other hand, are violated by a subset of segments. Second, the three cases of icy targets can be modeled using constraints on feature heads. These constraints interact with other constraints, which has a different effect in each of the languages. In Ikwere, the two alignment constraints are ranked differently with respect to the constraint on feature heads. Thus, icy targets are limited to rightward spreading. In Icelandic, on the other hand, MAXLINK[open] outranks the constraints on feature heads in unreduced roots, but not in reduced ones. Therefore, icy targets are preferred to raising in unreduced roots, while the situation is reversed in reduced roots. The contribution of this chapter is to show that these three different languages are typologically similar. BDT successfully traverses any differences and reveals the icy target pattern, which can be analyzed in a uniform and straightforward way.

## 4.6 Alternatives

BDT significantly modifies the representation of feature spreading. The most compelling evidence for it comes from icy targets. Recall section 4.1 in which I have shown that a classical autosegmental approach has no analysis of icy targets. The reason lies in that no constraint stops spreading on a target. While showing that an autosegmental approach based on well-established constraints (such as alignment and faithfulness) cannot capture icy targets is a sufficient condition for crucially modifying the concept of association, it is also necessary to show that other approaches to assimilation cannot model icy targets.

In this section, I flesh out why four other approaches fail to fully account for icy targets. In section 4.6.1, I first discuss feature domain theories. These will be shown to be too restrictive and cannot account for icy targets. In section 4.6.2, I point out that non-iterativity resembles icy targets, but is crucially different. In section 4.6.3, I discuss the positional licensing approach. While licensing can easily account for the main pattern, I argue that it fails to account for all the data. In

section 4.6.4, I introduce sequential markedness constraints. These constraints can model icy targets, but they also predict many unattested patterns. On the other hand, BDT is shown to predict icy targets without excessive overgeneration.

The arguments below are based on a single instance of icy targets taken from Icelandic. Recall that in Icelandic, [round] can spread from a high vowel to target an open vowel. This target concurrently blocks spreading to another target. The relevant slightly abstracted representation is in (121). I leave out all non-crucial information. The final vowel is associated with [round] but not [open]. The preceding vowels, on the other hand, are associated with [open] but not [round].

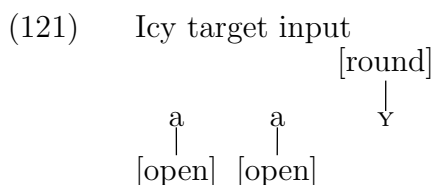

I consider only the outputs of (121) in which [round] is affected. At least four outputs are possible (and cross-linguistically attested): (i) no spreading, (ii) spreading of [round] to one root node only (icy targets), (iii) spreading to all root nodes, and (iv) delinking of [round].

### 4.6.1 Feature domain theories

Feature domain theories differ from Autosegmental Phonology in that they assume no association lines. Instead, assimilation is characterized in terms of domains. When a feature is contained within a single segment, the domain of that feature is contained to that segment. When a feature is realized on multiple segments as a result of assimilation, the domain of that feature is extended from a single trigger to encapsulate all targets. At first such a representation appears to be a notational variant of association lines. In particular, a target associated to a feature is equivalent to a target within a domain of a feature. However, there are several differences between the two theories. The one especially relevant to the issue at hand is that domains are headed. Typically, a trigger is also a head. This is a noteworthy departure from the classic autosegmental approach to feature spreading which represents triggers and targets identically in the output. Furthermore, heads may also mark segments other than triggers. For example, a constraint may require a head to be at the edge of a domain. Thus, the target furthest from the trigger could also be a head. This target is icy in the present context. Because constraints may refer exclusively to heads, it seems plausible that these constraints might be able to capture the icy target pattern, which is what happens in BDT.

Several different feature domain theories have been proposed. The most established ones are Optimal Domains Theory (Cassimjee & Kisseberth 1989; Kisseberth 1994; Cole & Kisseberth 1995a,b; Cassimjee & Kisseberth 1998), Span Theory (McCarthy 2004), and Headed Domains Theory (Smolensky 2006; my designation). These theories differ slightly from one another, but not in a way that would be relevant to icy targets. Thus, I will illustrate the treatment of icy targets on only one feature domain theory, and the conclusions are valid for the rest.

The common point that BDT has with feature domain theories is the concept of heads. Heads can be referred to by constraints. Smolensky (2006:621ff.) makes use of the general markedness constraint \*HEAD ( $\equiv$  Assign a violation mark for every root node that is a head) and Local Conjunction (Smolensky 1993, 1995, 1997; Baković 2000; Łubowicz 2002a,b, 2005). When two constraints are locally conjoined, such a locally conjoined constraint incurs a violation mark only when both of the constraints are violated within a specified local domain. Thus, Local Conjunction contains three variables: two constraints and a domain of conjunction. The general format of Local Conjunction is in (122).

- (122) Local Conjunction (Smolensky 1993, 1995, 1997)  
 $C = [C_1 \& C_2]_D$  is violated iff both  $C_1$  and  $C_2$  are violated in a local domain  $D$ .

When \*HEAD is locally conjoined with another constraint, the conjoined constraint will incur violations only when the second constraint is violated within a head. Such a conjoined constraint cannot be violated outside of a head. This interacts with another restriction of the theory, which is that each domain has exactly one head. This means that \*HEAD&C can not only be violated maximally once per head but also maximally once per domain, since no domains have multiple heads.

We have already seen in (81) that non-conjoined constraints cannot generate an icy target candidate, and this is also true in feature domain theories. However, these can also contain constraints referring to heads. In Smolensky's approach, these constraints are formally conjunctions. I present the effect of five conjoined constraints in the tableau in (123). The original notation is retained: each domain is between a pair of parentheses, and heads are underlined. Feature specifications of the features [round] and [open] are added for each candidate. This approach also requires binary features, and conjoined constraints also refer to the negative value of the feature. Four candidates are presented: (a) has no assimilation, (b) contains an icy target, (c) has total assimilation and (d) total unrounding. The icy target candidate incurs a violation mark on every constraint except for the last and is harmonically bounded by the other three candidates.

(123) Icy targets harmonically bounded

| / a a ʏ / |           |           |           |           |           |           |
|-----------|-----------|-----------|-----------|-----------|-----------|-----------|
| [r]       | - - +     | *HD&*[+r] | *HD&*[-r] | *HD&*[+o] | *HD&*[-o] | *HD&ID(r) |
| [o]       | + + -     |           |           |           |           |           |
| a.        | (a a) (ʏ) |           |           |           |           |           |
| [r]       | - - +     | *         | *         | *         | *         |           |
| [o]       | + + -     |           |           |           |           |           |
| b.        | (a) (œ ʏ) |           |           |           |           |           |
| [r]       | - + +     | *         | *         | *         | *         |           |
| [o]       | + + -     |           |           |           |           |           |
| c.        | (œ œ ʏ)   |           |           |           |           |           |
| [r]       | + + +     | *         |           |           | *         |           |
| [o]       | + + -     |           |           |           |           |           |
| d.        | (a a ɪ)   |           |           |           |           |           |
| [r]       | - - -     |           | *         |           | *         | *         |
| [o]       | + + -     |           |           |           |           |           |

The reason why the icy target candidate cannot win in an approach based on headed feature domains is because of the restrictions on possible domains. In particular, each domain has exactly one head (Smolensky 2006:624). This means that the constraints on heads apply to maximally one segment per domain. If we look at (123), candidate (c) harmonically bounds the icy target (b). In candidate (c), the first and the second [œ] have equal status and do not violate any constraint on heads. On the other hand, BDT posits multiple heads within a sequence of segments that are associated with some feature. A form with total rounding—which can be seen in (100) as candidate (c)—has a head on the second [œ]. The same is not true for the icy target candidate, which has no heads. Consequently, the candidate with total spreading violates constraints on heads in BDT, whereas the icy target candidate does not. In the alternative approach proposed in Smolensky (2006) on the other hand, the second vowel of the candidate with total spreading does not contain a head. This means that this vowel does not violate any constraints on heads. Furthermore, the candidate with total spreading (123-c) has only one head, whereas the candidate with icy targets (b) has two heads, which incur violations of other constraints on heads. Consequently, the candidate with total spreading bounds the icy target candidate. We can conclude that this approach fails to predict the candidate with icy targets. This can be extended to other feature domain theories (such as Optimal Domains Theory and Span Theory), because they all assume at most one head per domain. In order for these theories to be able to capture icy targets, they would need to be modified to allow either multiple heads per domain or overlapping/recursive domains, as it this the case in BDT.

To sum up, feature domain theories cannot generate an icy target candidate, which is an attested pattern and predicted by BDT.

### 4.6.2 Non-iterativity

In this section, I compare icy targets with non-iterativity. I demonstrate that the constraints driving non-iterative assimilation cannot successfully account for icy targets.

In assimilation, non-iterativity involves spreading to exactly one target. These patterns are particularly common in tone assimilation, as found in many Bantu languages (see Kisseberth & Odden 2003 for an overview), Japanese, and Serbo-Croatian (see section 4.2.3 of this thesis for further discussion). Icelandic u-umlaut also involves rounding of exactly one /a/, whereas all other potential targets are normally not affected. On the face of it, then, non-iterativity could also account for icy targets.

The distinction between iterative and non-iterative assimilation can be captured in either a rule- or constraint-based grammar. Here, I will take on the latter approach, because it allows for a direct comparison of non-iterative spreading with icy targets in BDT. In OT, non-iterative assimilation is attributed to constraint interaction. Non-iterative assimilation needs to be distinguished from other cases of assimilation, and requires a separate constraint. As to what this constraint is, at least three different proposals can be found in the literature.

The first option is a constraint that penalizes singly associated segments. For example, the constraint \*MONOF[EATURE]D[OMAIN] requires that a feature domain contains at least two segments/moras/syllables (Cassimjee & Kisseberth 1998). This constraint is satisfied by any spreading, and faithfulness or other markedness constraints prefer spreading to fewest segments, which results in spreading to one target. In short, the first proposal imposes a limit on the fewest segments associated with a feature. The second proposal, on the other hand, imposes a limit on the most segments associated with a feature. For example, LOCAL (Myers 1997; Yip 2002) is violated by shifting or spreading to a segment/mora/syllable that is non-adjacent to the trigger. A very similar constraint is BINARYASSOCIATION[f] which I will use in this section (see below). The third and final proposal is a constraint that is satisfied only when the relevant feature is associated to *exactly* two segments. Example of this kind are the constraints SPANBIN[f] (Becker 2007; Key 2007) and BINARY[f] (Uffmann 2005).

Even a short overview of the three approaches reveals a common property. Namely, there needs to be a constraint designed specifically for non-iterative spreading, even though there seems to be some disagreement what exactly this constraint is. Any of these constraints predict non-iterative assimilation, and there is no reason to assume they would differ in their treatment of icy targets. Thus, it

seems reasonable to look at a single constraint and generalize the findings for all other similar constraints.

I will consider a constraint that makes a restriction on the top number of segments associated with a feature—`BINARYASSOCIATION[round]` after Topintzi & van Oostendorp (2009). The definition is in (124).

(124) `BINARYASSOCIATION[round]` (adapted from Topintzi & van Oostendorp 2009)

The feature `[round]` can be associated with maximally two segments.

In Icelandic, this constraint interacts with the general ranking of `*ω[vowel, round]`  $\gg$  `DEPLINK[round]`. When `BINARYASSOCIATION[round]` is ranked above the alignment constraint, non-iterative spreading is preferred. Tableau (125) shows the Icelandic icy target pattern in roots without reduction. Candidate (d) with total spreading is ruled out by the binarity constraint, while delinking of `[round]` found in candidate (d) violates the high ranked faithfulness constraint `MAXLINK[round]`. Of the remaining constraints, `*ω[vowel, round]` prefers the icy target candidate (b) over the faithful (a).

(125) Icy targets predicted under non-iterativity

|                  |                                                                                                                                                        | <code>MAXLk[rd]</code> | <code>BINASS[rd]</code> | <code>*ω[vow,rd]</code> | <code>DEPLK[rd]</code>   <code>*œ</code> |
|------------------|--------------------------------------------------------------------------------------------------------------------------------------------------------|------------------------|-------------------------|-------------------------|------------------------------------------|
|                  | $\begin{array}{c} \text{[rd]} \\ \downarrow \\ / \text{ a } \text{ a } \text{ y } / \\ \uparrow \quad \uparrow \\ \text{[op]} \text{[op]} \end{array}$ |                        |                         |                         |                                          |
| a.               | $\begin{array}{c} \text{[rd]} \\ \downarrow \\ \text{ a } \quad \text{ a } \\ \uparrow \quad \uparrow \\ \text{[op]} \text{[op]} \end{array}$          |                        |                         | **!                     |                                          |
| b. $\rightarrow$ | $\begin{array}{c} \text{[rd]} \\ \swarrow \downarrow \\ \text{ a } \quad \text{ œ } \\ \uparrow \quad \uparrow \\ \text{[op]} \text{[op]} \end{array}$ |                        |                         | *                       | *   *                                    |
| c.               | $\begin{array}{c} \text{[rd]} \\ \swarrow \downarrow \\ \text{ œ } \quad \text{ œ } \\ \uparrow \quad \uparrow \\ \text{[op]} \text{[op]} \end{array}$ |                        | *!                      |                         | **   **                                  |
| d.               | $\begin{array}{c} \text{ a } \quad \text{ a } \quad \text{ i } \\ \uparrow \quad \uparrow \\ \text{[op]} \text{[op]} \end{array}$                      | *!                     |                         |                         |                                          |

We can conclude that the basic icy target pattern is predicted by the non-iterativity approach. However, this approach cannot see what segments are triggers and targets. In particular, `BINASS[round]` prefers non-iterative spreading regardless of



the vowel quality of the trigger, even if this segment an /œ/, which is not attested in Icelandic. Tableau (126) shows the incorrect prediction for the form [amœba] ‘amoeba’. Candidate (b) best satisfies both binarity and alignment. The intended winner (a) fatally violates alignment.

(126) Non-iterative spreading preferred with underlying /œ/

|      | $\begin{array}{c} \text{[rd]} \\ / \text{ a } \text{ m } \text{ œ } \text{ b } \text{ a } / \\ \text{[op]} \quad \text{[op]} \quad \text{[op]} \end{array}$ | BINASS[rd] | * $\omega$ [vow,rd] | DEPLK[rd]   *œ |
|------|-------------------------------------------------------------------------------------------------------------------------------------------------------------|------------|---------------------|----------------|
| a. ☹ | $\begin{array}{c} \text{[rd]} \\ \text{ a } \text{ m } \text{ œ } \text{ b } \text{ a } \\ \text{[op]} \quad \text{[op]} \quad \text{[op]} \end{array}$     |            | *!                  | *              |
| b. ☺ | $\begin{array}{c} \text{[rd]} \\ \text{ œ } \text{ m } \text{ œ } \text{ b } \text{ a } \\ \text{[op]} \quad \text{[op]} \quad \text{[op]} \end{array}$     |            |                     | * **           |

We have now seen that icy targets are a pattern distinct from non-iterativity. While icy targets involve a restriction on spreading of one feature due to another feature, non-iterative spreading involves exactly one target.

A separate, but perhaps even more serious question is whether non-iterativity is found in assimilation at all. Because of the facts just mentioned, icy targets cannot be reanalyzed as non-iterative assimilation. However, there might be other patterns that are indeed non-iterative. One such example is Lango vowel harmony (section 3.4.1). Recall that Lango has [atr] harmony triggered by a suffix vowel, and only the closest root vowel is targeted. This resembles non-iterativity, because only one target is involved. However, I have analyzed Lango in a way that does not require a special constraint for non-iterativity. Instead, the interaction of multiple alignment constraint is entirely sufficient.<sup>9</sup> The idea is that some alignment constraints prefer spreading to any number of targets within a morphological domain. In section 5.4, we will see that a similar constraint is required in an analysis of C’Lela. In both languages, the winning candidate has a single target because of a low ranked faithfulness, which prefers spreading to fewest targets. Thus, no special constraint for non-iterative spreading is required. What seems to be the case is that non-iterativity in these languages is only epiphenomenal.

<sup>9</sup>In addition, Lango is well-known in the literature for the interactions between [atr] and vowel height/backness which determine the directionality of assimilation (see Okello 1975; Bavin Wook & Noonan 1979; Noonan 1992; Archangeli & Pulleyblank 1994; Smolensky 2006; Kaplan 2008a,b; Potts et al. 2010 for details). This indicates that what matters in Lango are restrictions on triggers, not non-iterativity.

The remaining issue is whether pure non-iterativity is at all attested in assimilation. To the best of my knowledge, all cases of non-iterativity can be reanalyzed in a fashion similar to Lango and C'Lela. For example, non-iterative spreading in obstruent voicing and consonant place assimilation may have to do with the fact that languages rarely allow more complex clusters, and the fact that vowels block assimilation. Kaplan (2008b) takes on these ideas, and makes a strong claim that non-iterativity is *always* emergent. To the best of my knowledge, the only convincing cases of non-iterative spreading involve tone. I remain agnostic whether the approach in this thesis can be extended to capture such patterns.

### 4.6.3 Positional licensing

Positional licensing is introduced in section 3.4.1. Recall that positional licensing capitalizes on the idea that prominent positions bear more contrast than non-prominent positions. A feature realized on a prominent position has a different status than one realized on a non-prominent position. In terms of constraints, positional markedness constraints may require a feature to be associated with a prominent position. This is directly relevant to the Icelandic u-umlaut. In Icelandic, [round] spreads from a suffix until it reaches an open vowel.<sup>10</sup> That holds for roots without reduction (the first target satisfies the requirement and spreading is terminated) and for roots with reduction (subsequent targets are raised and spreading continues until an open vowel is reached). From the perspective of positional licensing, [round] spreads until it reaches a prominent feature, [open]. In other words, the realization of [round] on [open] segments is more prominent than realization on other segments (see section 8.4 for further discussion). This can be formalized in terms of a positional markedness constraint (127).

- (127) LICENSE([round], [open]) (adapted from Walker 2005:941–942)  
 An output [round] must be associated with an [open] vowel.

A high ranked LICENSE([round], [open]) prefers spreading to [open] vowels rather than any other segment. Furthermore, spreading to any number of [open] segments satisfies the constraint, and faithfulness prefers candidates with least spreading. This effect is shown in (128). The icy target candidate (b) wins when the licensing constraint outranks DEPLINK[round]. In contrast candidate (a) violates the licensing constraint, because it has no [œ]. Candidate (c) shows total spreading, and violates DEPLINK[round] twice. Candidate (d) violates the highest ranked MAX[round].

---

<sup>10</sup>Thanks to Christian Uffmann for bringing this alternative to my attention.



faithful to the input. This is also the reason why (c) harmonically bounds the intended winner (b).

## (129) The Richness of the Base argument

|    | MAX[rd] | LIC([rd],[op]) | DEPLINK[rd] | MAXLINK[rd] |
|----|---------|----------------|-------------|-------------|
| a. |         | *!             |             | **          |
| b. |         |                |             | *!          |
| c. |         |                |             |             |
| d. | *!      |                |             |             |

Another argument against the positional licensing approach stems from forms without an output [œ]. Recall that reduction raises the round [œ] to [y]. When there are no further targets, such an [y] surfaces alone, and these forms do not contain any [œ]. The positional licensing constraint LICENSE([round], [open]) (127) is violated in such forms, because no [œ] is associated with [round]. Hence, there is no incentive to spread in the first place, and low ranked faithfulness constraints prefer no spreading at all.

The problem is illustrated in (130). The reduced form *h[ε]r[y],ð[y]m* ‘district’ has a single available target. Reduction needs a separate account and I follow Crosswhite (2001) by using a constraint that penalizes unstressed open round vowels, \*UNSTRESSED/œ (≡ Assign a violation mark for every unstressed [œ]). This constraint dominates the licensing constraint, since otherwise no reduction would have applied. The actual winner is candidate (b), which contains a reduced [y]. However, this candidate is harmonically bounded to the faithful candidate (a). This is because spreading [round] to any other vowel but [œ] does

not satisfy the licensing constraint. Candidate (c) fatally violates the high ranked \*UNSTRESSED/œ.

(130) 'hɛrɪd̥ɪm 'district'

|                  |                                                                                                                                                       | *UNSTR/œ | LIC([rd],[op]) | DEPLINK[rd] | MAX[op] |
|------------------|-------------------------------------------------------------------------------------------------------------------------------------------------------|----------|----------------|-------------|---------|
|                  | $\begin{array}{ccccccc} & & & & [r] & & \\ & & & &   & & \\ / & h & \varepsilon & r & a & d & \dot{y} & m / \\ & [o] & & [o] & & & & \end{array}$     |          |                |             |         |
| a. $\rightarrow$ | $\begin{array}{ccccccc} & & & & [r] & & \\ & & & &   & & \\ ' & h & \varepsilon & r & a & d & \dot{y} & m \\ & [o] & & [o] & & & & \end{array}$       |          | *              |             |         |
| b. $\rightarrow$ | $\begin{array}{ccccccc} & & & & [r] & & \\ & & & & / & & \\ ' & h & \varepsilon & r & \dot{y} & d & \dot{y} & m \\ & [o] & & & & & & \end{array}$     |          | *              | *(!)        | *(!)    |
| c.               | $\begin{array}{ccccccc} & & & & [r] & & \\ & & & & / & & \\ ' & h & \varepsilon & r & \dot{y} & d & \dot{y} & m \\ & [o] & & [o] & & & & \end{array}$ | *!       |                | *           |         |

In short, under no ranking of these constraints can the reduced candidate (b) win. The reason behind that is in the licensing constraint, which is responsible for feature spreading. Spreading to any non-high vowel cannot be attributed to this constraint. In contrast, BDT relies on alignment constraints that prefer spreading, all other things being equal, as shown in (101).

I have now shown that an analysis based on positional licensing fails to fully account for icy targets. The representational solution of BDT thus seems to be the only viable solution so far.

#### 4.6.4 Sequential Markedness Constraints

Sequential Markedness Constraints (henceforth, SMCs) are constraints against a sequence of segments with a particular feature combination: \* $[\alpha F][\beta G]$ . These are frequently used in OT. We have already seen one example: OCP constraints in (66)–(68) are formally constraints against a sequence of features at a particular distance.

Mahanta (2007) makes the concept of SMCs explicit and demonstrates it on vowel harmony in Assamese and Bengali. Both languages exhibit regressive [ATR] harmony which spreads from an underlying root or suffix vowel. The constraint AGREE[ATR] cannot capture this pattern, since it prefers bidirectional spreading. In particular, AGREE[ATR] is violated by any sequence of vowels that differ in the value of the feature [ATR]. Mahanta's solution is in an SMC \* $[-ATR][+ATR]$ .

This constraint penalizes only sequences consisting of a  $[-ATR]$  vowel followed by a  $[+ATR]$  vowel, but not the reverse. The actual situation in Bengali is more complex: the trigger of ATR harmony must be a high vowel. The required SMC thus needs to be more specific. The constraint  $*[-ATR][+ATR +high]$  targets only  $[-ATR]$  vowels followed by  $[+ATR +high]$  vowels. Thus, the possible SMCs can refer to a string of two (and possibly more) segments with any combination of features.

Recall that in Icelandic u-umlaut,  $[round]$  and  $[front]$  spread from  $/y/$  to a preceding  $/a/$ . The prohibited sequence in Icelandic is  $[ay]$ , which violates the SMC  $*_{ay}$ , as defined in (131).

$$(131) \quad *_{ay} \quad * \begin{bmatrix} -front \\ -round \\ +low \end{bmatrix} \begin{bmatrix} +front \\ +round \\ -low \end{bmatrix}$$

The constraint in (131) targets any sequence of adjacent  $[a]$  and  $[y]$  (ignoring any intervening consonants). Inputs with a sequence  $/aC_0y/$  map to the output sequence  $[æC_0y]$ . This is assured by other constraints that interact with  $*_{ay}$ .  $DEP[+round]$  (and  $DEP[+front]$ , omitted) are ranked below  $*_{ay}$ , while the high ranked  $MAX[+round]$  assures that  $[+round]$  is not deleted. The ranking is shown in (132). The candidates are parallel to the ones in tableaux (123) and (128).<sup>11</sup> The winning candidate (b) violates solely  $DEP[+round]$ , as opposed to candidate (a) that violates  $*_{ay}$ , and candidate (d) that violates  $MAX[+round]$ . The remaining candidate (b) incurs two violations of  $DEP[+round]$ . On the face of it, the SMC  $*_{ay}$  has the desired effect and can capture the icy target pattern.

(132) Icy targets correctly predicted

|    | /a a y/ | MAX[+round] | * <sub>ay</sub> | DEP[+round] |
|----|---------|-------------|-----------------|-------------|
| a. | a a y   |             | *!              |             |
| b. | ☞ a œ y |             |                 | *           |
| c. | œ œ y   |             |                 | **!         |
| d. | a a i   | *!          |                 |             |

However, SMCs come with their own set of problems. Here I discuss three. First, SMCs refer to two adjacent vowels, ignoring any intervening consonants. On the one hand, the constraint  $*_{ay}$  is violated by the string  $[ay]$ , but not by  $[ajy]$ . On the

<sup>11</sup>These faithfulness constraints are not used by Mahanta (2007), who uses  $IDENT(f)$  constraints instead.

other, the constraint  $*_{aY}$  is *not* violated by  $[ak\underline{y}]$ ,  $[a\underline{\theta}y]$  or  $[ar\underline{\delta}y]$ . Because SMCs require full binary feature specification, there is no common property of the targeted segments (vowels) that would maintain the Locality Condition over the transparent segments (consonants). The necessary assumption is that consonants lack any value of the features [front], [round] and [low]. This indicates that spreading of these features from a consonant to a vowel (and vice versa) is excluded. However, such patterns are attested.

Second, SMCs produce pathologies. These pathologies are particularly severe when SMCs are highly ranked. Consider for example the ranking  $*_{aY} \gg \text{DEP}[+\text{round}] \gg \text{MAX}$ . The following two patterns are predicted. An input  $/a \gamma/$  maps to an output with an epenthetic vowel rather than spreading, as shown in (133). However, an input  $/\text{œ} \gamma/$  can surface faithfully, as shown in (134). The pattern in which the combination of two different vowel features forces epenthesis is unattested. This pathology is an instantiation of the too-many-solutions or too-many-repairs problem (see Pater 1999; Wilson 2000, 2001; Steriade 2001, 2001/2008; Blumenfeld 2006; Baković 2007 for related cases). What makes this pathology a too-many-solutions problem is that a markedness constraint can be satisfied by several candidates, a subset of which is actually attested. Nothing in BDT has the same effect.

## (133) Epenthesis over spreading

|    | $/a \gamma/$                 | $*_{aY}$ | $\text{DEP}[+\text{round}]$ | $\text{MAX}$ |
|----|------------------------------|----------|-----------------------------|--------------|
| a. | $a \gamma$                   | *!       |                             |              |
| b. | $\text{œ} a \text{œ} \gamma$ |          |                             | *            |
| c. | $\text{œ} \gamma$            |          | *!                          |              |

## (134) No epenthesis

|    | $/\text{œ} \gamma/$ | $*_{aY}$ | $\text{DEP}[+\text{round}]$ | $\text{MAX}$ |
|----|---------------------|----------|-----------------------------|--------------|
| a. | $a \gamma$          | *!       |                             |              |
| b. | $a \text{œ} \gamma$ |          |                             | *!           |
| c. | $\text{œ} \gamma$   |          |                             |              |

Third, the approach based on SMCs entails a much larger set of constraints. The SMC  $*_{aY}$  in (131) refers to three features and two segments that have exactly the opposite feature specification. One can easily imagine a number of very similar constraints. When two or more features are involved in each segment, the number of constraints grows exponentially. For example, for  $n$  binary features,  $16n^2(n-1)^2$  constraints of the type  $*[\alpha F \beta G][\gamma H \delta I]$  are possible. Just 10 binary features yield

129,600 constraints. Furthermore, nothing restricts an even greater number of features or more segments in SMCs, consequently generating many more constraints. BDT can never generate such a large number of constraints, because any constraint on heads only refers to two unary features. For  $n$  privative features, only  $n(n - 1)$  constraints of the type \*[F g] are possible; 10 privative features allow maximally 90 different constraints. In this chapter, four such constraints were discussed: \*[ROUND open] (99) and \*[FRONT open] in Icelandic, \*[RETROFLEX stop] (108) in Sanskrit, and \*[NASAL stop] (116) in Ikwere.

In short, SMCs predict icy targets, but can additionally generate many other unattested patterns. From the viewpoint of assimilation, SMCs are not restrictive enough. BDT, on the other hand, perfectly predicts icy targets and at the same time, BDT does not overgenerate and produce additional unattested patterns.

## 4.7 Summary

The contribution of this chapter is two-fold. The empirical contribution is in identifying a new, previously unreported class of segments, named icy targets. The theoretical contribution is an account of icy targets by modifying some fundamental assumptions regarding feature spreading.

Icy targets resemble targets in that they are subject to assimilation. At the same time, however, they act as blockers and terminate any further assimilation. Under the traditional assumptions about assimilation, icy targets are surprising, because the sets of targets and blockers are normally disjunctive.

No known theory predicts icy targets. In response to this challenge, I propose that feature spreading should be fundamentally revised. In particular, the traditional notion of association should be complemented by a restriction that all spreading is maximally binary. Such a proposal has been set forth by some early autosegmental literature. Binary Domains Theory (BDT) revives it and incorporates binarity, headedness and recursion into the theory of autosegmental spreading. These concepts are well supported throughout linguistic theory and it is not surprising that the evidence for them can also be found in assimilation.

The main restriction of BDT is that all branching is maximally binary. Spreading to more than one target creates recursive domains. Each domain consists of two segments, one head and one dependent. This predicts that all but the final target will be headed. Since constraints may refer to heads but not dependents, all but the final target may be subject to additional restrictions. The restrictions on feature heads can be formalized by extending prosodic constraints on heads to features. In BDT, heads of a feature [f] that are also associated with [g] violate such a constraint.



BDT has several other predictions that will play a vital role in the subsequent chapters. In particular, BDT establishes two types of relationships between a feature and a segment. Some segments may contain a head of a particular feature, while others cannot. In other words, a feature may be more prominently associated with some segments but not with others. This also suggests there might even be more levels of prominence.

In short, BDT takes on representations of Metrical Theory and applies them to feature spreading. This allows for a unified account of segmental and prosodic phenomena. Even though there are significant differences between prosody and assimilation, their common properties suggest that feature spreading and prosody are much more similar to each other than previously assumed.



## Chapter 5

# Transparent segments

Targets of assimilation have been the center of analysis so far. In chapter 2, I reviewed the three basic parameters of assimilation and presented an analysis based on a single class of alignment constraints. These constraints contain three variables: a spreading feature, a targeted structure, and a domain. The alignment constraints prefer spreading to a natural class of targets, which can be characterized in terms of a single phonological feature. In chapter 3, I demonstrated that the same spreading feature may affect different sets of targets. Crucially, these sets are not random: spreading to some segments implies spreading to others. This is attributed to the typology of alignment constraints and the relationship between a spreading feature and a targeted structure.

In chapter 4, I presented data that identify two types of targets. Regular targets cannot interfere with spreading, while icy targets terminate further spreading. In response to these puzzling data, I proposed a revision of the representation of feature spreading. In classic Autosegmental Phonology, a feature may be linked to any number of root nodes, which makes it impossible to distinguish the two types of targets. In contrast, most metrical representations posit a restriction on branching, which is maximally binary. Icy targets are predicted only by this later approach.

I extend the representations of Metrical Theory to feature spreading. According to Binary Domains Theory, branching is maximally binary. Spreading to multiple targets results in recursive feature nodes. Furthermore, any binary branching feature node is associated to two different elements: one is a head, while the other is a dependent. This novel concept of association allows for the distinction between two types of targets. Icy targets can be dependents of a feature but not heads, while regular targets can be either. This leads to the conclusion that feature spreading involves different types of relationships. More specifically, relationships between a feature and a root node will differ from segment to segment. Some

segments display a greater degree of prominence with respect to the spreading feature, which is formally represented by heads.

In this chapter, I extend the idea that association may represent different types of relationships. We have already seen that association may be of two types: some segments are heads of a feature, while others are dependents. At the same time, however, all targets are to some degree equivalent with respect to the feature, which allows for distinguishing them from skipped non-targets, such as transparent segments. Classic Autosegmental Phonology assumes that targets are associated with the spreading feature, while transparent segments are not. Instead, I propose an extension of the hierarchy of association to capture the difference between targets and transparent segments. That is, both targets and transparent segments are associated with the spreading feature, but the association represents two different relationships.

This chapter is organized as follows. Section 5.1 provide an argument for the distinction between transparent segments and targets. In most cases, spreading prefers closer targets over distant targets, within a domain. Alignment constraints are not able to capture this preference, because they are equally violated by any unassociated target within a domain. In response to this challenge, section 5.2 presents a representational solution which is a rather simple extension of BDT. According to this solution, transparent segments are also associated with the spreading feature, although in slightly different terms than targets. The representational modifications are complemented by an upgrade of constraints involved in assimilation. The following three sections discuss three cases of transparency. Section 5.3 provides an analysis of transparency in Icelandic. In Icelandic, no vowel can be transparent. This follows directly from the constraints on feature heads. Section 5.4 presents an opposite pattern in c'Lela, in which all non-final vowels are transparent. This pattern is attributed to a particular type of alignment constraints. Section 5.5 is an analysis of Finnish vowel harmony, which represents an intermediate situation where some segments are transparent while others are not. The Finnish pattern allows a closer examination of the relationship between targets and transparent segments. Section 5.6 concludes.

## 5.1 Introduction

Feature spreading processes have a markedly local character. More specifically, spreading to a target far from the trigger will generally imply spreading to all intermediate identical targets, but not necessarily vice versa. To put it differently, if an assimilation pattern cannot distinguish between multiple targets, it will normally affect the one closest to the trigger. The current approach based on alignment constraints has so far not provided for a mechanism to capture this

generalization. In particular, when spreading to a single target is preferred, alignment constraints cannot distinguish among available targets. This is because all unassimilated targets incur the same number of violation marks, as long as they are within a domain containing the spreading feature.

Recall Icelandic u-umlaut (section 4.3). The pattern involves an underlying /ʏ/, which rounds and fronts an /a/ to [œ]. In roots without reduction, only an /a/ that immediately precedes the trigger is affected. The rule does not affect a other /a/. This means that spreading never skips any vowel in Icelandic. However, we have already seen that vowels may be skipped by a feature in other languages. For example, Wolof—analyzed in section 3.2.3—shows spreading of RTR only to [open] vowels, skipping any intervening [high] vowels. An alignment constraint that contains [open] as the targeted structure can easily describe this pattern, as [high] vowels do not incur violation marks. However, alignment cannot restrict spreading to apply only to the syllable that is immediately adjacent to the trigger. This is what happens in Icelandic, where only the closest vowel is affected.

While this problem is also found in other approaches to feature spreading, it becomes much more explicit with hierarchical representations in BDT. Recall that BDT distinguishes targets that contain a feature head from the ones that do not. A dominant constraint on feature heads prefers spreading to exactly one target. However, the relevant alignment constraint is unable to distinguish between multiple targets. Tableau (135) illustrates this point. The high ranked constraint on feature heads excludes candidate (d) with spreading to all targets. Of the remaining candidates, two show spreading to one target: (b) to the second vowel and (c) to the first vowel. Neither the alignment constraint nor the faithfulness constraint can distinguish among these two candidates. The problem is that only (b) is actually attested.

(135) japœnym ‘Japanese.DAT.PL’

|                 |                                                                                                                                                       |          |                   |             |
|-----------------|-------------------------------------------------------------------------------------------------------------------------------------------------------|----------|-------------------|-------------|
|                 | $\begin{array}{c} \text{[rd]} \\   \\ / j \ a \ p \ a \ n - \ y \ m / \\   \quad   \\ \text{[op]} \ \text{[op]} \end{array}$                          | *[RD op] | $\omega$ [vow,rd] | DEPLINK[rd] |
| a.              | $\begin{array}{c} \text{[rd]} \\   \\ j \ a \ p \ a \ n \ y \ m \\   \quad   \\ \text{[op]} \ \text{[op]} \end{array}$                                |          | **!               |             |
| b. $\leftarrow$ | $\begin{array}{c} \text{[RD]} \\ / \quad \backslash \\ j \ a \ p \ \text{œ} \ n \ y \ m \\   \quad   \\ \text{[op]} \ \text{[op]} \end{array}$        |          | *                 | *           |
| c. $\leftarrow$ | $\begin{array}{c} \text{[RD]} \\ / \quad \backslash \\ j \ \text{œ} \ p \ a \ n \ y \ m \\   \quad   \\ \text{[op]} \ \text{[op]} \end{array}$        |          | *                 | *           |
| d.              | $\begin{array}{c} \text{[RD]} \\ / \quad \backslash \\ j \ \text{œ} \ p \ \text{œ} \ n \ y \ m \\   \quad   \\ \text{[op]} \ \text{[op]} \end{array}$ | *!       |                   | **          |

The Icelandic u-umlaut data reveal a more general property of assimilation, which is that local targets are generally preferred over distant targets. Icelandic has a separate restriction which limits spreading to maximally one open target. U-umlaut affects the target closest to the trigger, even if multiple identical targets are available.

Tableau (135) shows that alignment constraints do not prefer closer targets over distant targets, as long as they are within the relevant domain. There are several possible directions to take in order to resolve this challenge. Perhaps the most obvious solution is to introduce a constraint that restricts skipping of possible targets. This constraint is known as NOGAP[f] ( $\equiv$  Let  $\times_i < \times_j < \times_k$ . Assign a violation mark for every [f] that is linked to  $\times_i$  and  $\times_k$ , but not also to  $\times_j$ ). This constraint penalizes any skipped configuration (Kiparsky 1981; Levergood 1984; Kirchner 1993; Archangeli & Pulleyblank 1994; Beckman et al. 1995; Itô et al. 1995; Kaun 1995; Ní Chiosáin & Padgett 1997, 2001; Walker 1998). There are several problems with this approach. The most serious of them is that a string of transparent segments violates NOGAP[f] only once. When an output contains no transparent segments, NOGAP[f] is not violated and classic gradient alignment prefers spreading to all targets. When an output contains a single transparent

segment (which is protected by some other high ranked constraint), NOGAP[f] is violated only once. Adding additional transparent segments incurs no additional violation marks. Furthermore, the alignment constraint is satisfied equally by spreading to all remaining targets or only to the final one. Hence, faithfulness prefers spreading only to the final target. This results in a grammar in which a single transparent segment causes skipping of all but the final target. Such patterns are not attested.

The alternative solution is representational, and this is the direction I take. I demonstrate that u-umlaut gives an insight into how feature spreading works. The proposal consists of two steps. First, I posit a restriction on spreading, which is that it can never skip a root node. In the language of OT, Gen never generates skipped nodes. Second, I propose a representational account, which is a simple extension of Binary Domains Theory. I extend the notion that association lines represent different relationships. Recall that the disparity between regular and icy targets stems from the fact that regular targets are in a different relationship with the spreading feature in comparison to icy targets. This disparity is represented with heads. Similarly, targets are in a different relationship with the spreading feature than transparent segments are. I will claim that both targets and transparent segments are associated with a particular spreading feature, but the relevant associations represent two different relationships. This representational account can be further complemented by constraints.

## 5.2 Binary Domains Theory upgraded

In this section, I look at those non-targets that are between a trigger and a target of some assimilation process. I show that these transparent segments differ from segments that are beyond the final target. The arguments for such a conclusion are both phonological and phonetic. I propose an extension of BDT that captures the difference between a target and a transparent segment.

I first present a representational account that distinguishes transparent segments from targets (section 5.2.1). This is complemented by constraints (section 5.2.2).

### 5.2.1 Representations

Assimilation may affect a contiguous string of segments or not. An example of the first option is emphasis spread in Arabic (section 3.2.1), which generally does not skip any segments. In contrast, vowel harmony in Twi (section 3.2.2) affects only vowels, but ignores intervening consonants. In Wolof (section 3.2.3), this situation is even further constrained, such that only non-high vowels are affected.

The unaffected segments between a trigger and a target are *transparent* to the process.

One way to formalize transparent segments is to say that they are not associated with the spreading feature. This is a fairly standard assumption and stems from the fact that a particular feature is not realized on transparent segments. For example, there is only one set of high vowels in Wolof, which means that they do not alternate when flanked by RTR open vowels. A classical autosegmental account of transparency is a gapped configuration—(46), repeated below. In (136), we see a rule, which spreads [f] from  $\times_1$  to  $\times_3$  and  $\times_4$ . This rule skips the second segment;  $\times_2$  is transparent.<sup>1</sup>

(136) Transparency as a gapped configuration

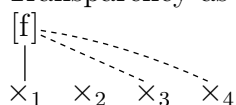

However, there is ample evidence that even transparent segments are affected by the spreading feature. Öhman (1966) was the first to measure the effect of one vowel quality on another vowel even across a consonant; this has subsequently been replicated by many studies (e.g. Recasens 1987; Fowler 1981; Magen 1997; Beddor et al. 2002; Modarresi et al. 2004; Benus 2005; Benus & Gafos 2007). While such a coarticulatory effect cannot automatically be considered phonological, it has been used to demonstrate the articulatory nature of vowel harmony (Browman & Goldstein 1986, 1989; Ohala 1994a,b; Gafos 1996/1999). Vowel harmony is undoubtedly a phonological pattern.

The question is whether vowel harmony—stemming from the coarticulatory effect among vowels—also affects consonants and transparent vowels. In terms of phonetics, the answer is yes. To illustrate, I shortly summarize the findings of two crucial studies. Boyce (1990) compares lip rounding of transparent non-labial consonants flanked by round vowels. She finds that Turkish speakers exhibit a plateau pattern in which lip rounding is retained in consonants. English speakers, on the other hand, show a decreased rounding on consonants, which can be characterized

<sup>1</sup>The committee notes that transparency is related to the fact that languages typically lack contrast on transparent segments. For example, Wolof does not distinguish between tense and lax high vowels, which is supposedly why high vowels can be skipped. The problem with such a conclusion is that not all assimilation patterns are like the one found in Wolof. In particular, some patterns involve transparency even on segments that have the relevant contrast. We will see at least two such examples in this thesis. In c’Lela (section 5.4), only the absolutely final vowel is subject to assimilation, and all other suffix vowels—even if identical to the target—are transparent. In Khalkha Mongolian (section 8.4.5), [i] is transparent to rounding (and backness) harmony, even though the language allows [u] in other positions. Given these two patterns, we have to conclude that contrast is not essential for a theory of transparency, despite the fact that it appears to be a possible alternative for *some* cases of assimilation.



as a trough pattern. These differences suggest that English exhibits no rounding harmony (and thus has no transparent segments). Turkish, on the other hand, has rounding harmony in which consonants are phonetically affected by the spreading feature.

Benus (2005), Benus & Gafos (2007) analyze Hungarian, which has backness harmony. Front vowels {i, e} are transparent to this process and can surface in a front or a back vowel word. It turns out that transparent vowels vary significantly depending on whether they are pronounced in a back vowel context or in a front vowel context. This suggests that vowels behave exactly like consonants in that they are phonetically affected if they are transparent.

Such a phonetic effect on transparent segments can be extended to patterns that involve consonants, such as nasal harmony or consonant harmony. Walker (1999) analyzes nasal harmony in Guaraní, which has transparent voiceless stops. While she does not find any evidence of nasal airflow during stops flanked by nasal segments (consistent with findings in Cohn 1990), she does find significant differences in voice onset time, which is longer in nasal contexts for labial and coronal stops. Walker et al. (2008) look at tongue tip and blade movement during sibilant harmony in Kinyarwanda. They found that the fricatives displayed the greatest difference in the angle between tongue tip and blade, which suggests they are actual targets. Transparent non-coronals (and the flap) in retroflex contexts showed lower, but still significant differences between retroflex and non-retroflex contexts. Non-fricative coronals are blockers and show no variation. This is consistent with the model in which a continuous articulatory gesture extends over the transparent segments, even if such an effect is not perceptible. We can conclude that there is evidence that ‘transparent’ segments are also affected by spreading, at least in terms of phonetics.

How does this relate to phonology? The contrast between transparent segments in an assimilation environment (i.e., between a trigger and a target) compared to other environments is clearly not the same as the contrast between an undergoing target and a non-undergoing target. For example, while front target vowels become back after back vowels in Hungarian, transparent {i, e} do not become back vowels, even though their articulation is significantly affected. This suggests that the relation between a spreading feature and its target is very different from the relation between a spreading feature and a transparent segment.

In response to these facts, perhaps the most obvious solution is to ignore the phonetic coarticulation and assume no spreading to transparent segments. This is the position taken by classic Autosegmental Phonology. The advantage of this approach is that it requires less theoretical machinery, since it requires only one type of relationship between a feature and a segment: association. The disadvantage, however, is that the coarticulation facts remain beyond phonology, and are

handed over entirely to phonetics or the phonetics-phonology interface. A more serious disadvantage of this approach is that it requires some sort of device to restrict skipping. Since the 1970s, much effort has been put into an account of how to restrict skipping that would fit the cross-linguistic data best (e.g. Howard 1972; Jensen 1974; Goldsmith 1976; Clements 1976/1980; Kiparsky 1981; Anderson & Ewen 1987; Archangeli & Pulleyblank 1987; Sagey 1990; Odden 1991, 1994; Halle 1995; Steriade 1995; Halle et al. 2000; Morén 2003; Nevins 2010).

An alternative solution is to say that spreading is always strictly local. This approach is based on the fact that features have a rather trivial phonetic (primarily articulatory) correspondent. For example, the phonological feature [round] has an articulatory correspondent in lip rounding. According to this view, there is no such thing as genuine transparency: all segments are affected by the spreading feature. The advantage of this view is that it is much simpler than the classic autosegmental account, since skipping is ruled out. Furthermore, this model allows to unify phonetics and phonology in that both affect a contiguous string of segments. On the other hand, the disadvantage of this approach is it needs a separate explanation for why a particular feature is realized differently on some segments than on others. For example, nasality sometimes spreads to and across voiceless stops, which lack any independent cues of nasality. This fact must be accounted for in some way. Much effort has been put into developing a realistic phonological model that would allow for a distinction between full targets and those targets lacking independent phonetic cues of the relevant feature (Itô et al. 1995; Padgett 1991, 1991/1995, Gafos 1996/1999; Walker 1998/2000; Ní Chiosáin & Padgett 1997, 2001; McCarthy 2004; Smolensky 2006).

What I am suggesting is that both approaches capture the right intuitions about locality in feature spreading, but neither gets it entirely right. The classic autosegmental approach is appealing because association has a direct phonological effect. The articulator-based approach is also appealing because of its simple and straightforward concept of locality. My solution is to take both elements and join them in a new theory of feature spreading. In particular, what I am advancing is that feature spreading always affects a contiguous string of segments. At the same time, association between a feature and a target is formally different from association between a feature and a transparent segment. The advantage of this position is that it can capture the difference between targets, transparent segments and other non-targets. At first it seems that this approach also comes with a drawback, namely that it is more complex than the two alternatives discussed above. However, I have already shown that feature spreading requires different types of relationships. In particular, I claimed that some segments may contain heads of a feature, while others cannot (section 4). If so, then having another level of hierarchy is not at all surprising and directly follows from BDT. I will take

this approach and show that it also makes other desirable predictions. For example, spreading to targets closer to a trigger does not need a separate explanation. Furthermore, transparent segments can be representationally contrasted with segments that block spreading and are not associated with a feature. Finally, the approach advocated in this thesis makes stronger parallels between segmental and prosodic structures. Without exception, prosodic domains consist of a contiguous string of segments, even though association lines may not be equivalent. For instance, no syllable can have an onset that is not immediately adjacent to a nucleus. BDT takes on this prosodic approach and transfers it to assimilation. BDT shares a representational distinction between transparent segments and targets with several other theories, including Turbidity Theory (Goldrick 2000; Finley 2008, 2009), Colored Containment (van Oostendorp 2005, 2007), and feature domain theories (e.g. Cassimjee & Kisseberth 1989; Kisseberth 1994; Cole & Kisseberth 1995a,b; Cassimjee & Kisseberth 1998; McCarthy 2004; Smolensky 2006).

Recall the representation of spreading according to BDT in (87), repeated below. In (137), we see a feature [f] that spreads from the first node  $\times_1$  and targets four consecutive root nodes. The representation involves only binary branching, which creates recursive nodes/domains. All but the final root node are heads of [f], marked by a capital F that is aligned with a particular root node. In addition, each root node (including the final one) is also linked to a non-branching node, marked by a lowercase f.

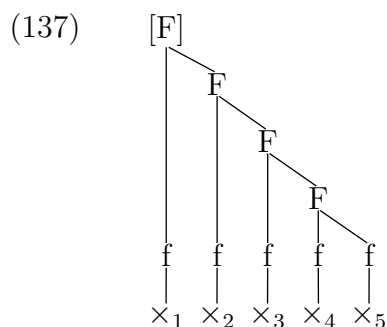

In this representation, there are two kinds of domains and nodes. The first kind is marked with uppercase letters (henceforth, *F*-node) and link a head and a dependent node. The second kind of domains are marked with lowercase letters (henceforth, *f*-node). *F*-nodes are higher constituents compared to *f*-nodes, which are parallel to prosodic representations, where feet are higher domains than to syllables or moras. Neighboring targets or a trigger–target pair are associated with the feature via a binary branching *F*-node, while each single target or a trigger is associated with the feature via a non-branching *f*-node. In BDT, this is a restriction on Gen and is always observed.

In (138), we see another two root nodes linked to the same feature. There are two f-nodes and one F-node. Crucially, the two root nodes are not strictly adjacent to one another. The intermediate root nodes  $\times_b$  and  $\times_c$  are transparent to spreading.

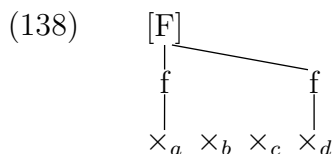

Recall the above discussion concerning transparent segments. I claim that transparent segments are similar to targets in that they are also associated with a feature, although in different terms than targets. What I propose is that targets are always linked to the feature through a non-branching (or unary) f-node, while transparent segments are not, but instead share an f-node with a trigger/target. This f-node represents a feature domain which is headed by a trigger/target, while a transparent segment is a dependent. In (139), we see the full representation which involves a trigger, a target and two intermediate transparent segments. The trigger and the target are linked to a non-branching f-node, through which they are linked to a higher F-node. Transparent segments are not linked to the feature via a non-branching f-node. Instead, they are associated with an f-node that is headed by the trigger. Because all branching is maximally binary, each transparent segment requires its own f-node, shared only with a trigger/target and not with any other transparent segment. A transparent segment thus always results in a recursive f-node, which is headed by a trigger/target. In (139), there are three f-nodes on the leftmost root node  $\times_a$ . The lowest one is a non-branching f-node. The second from the bottom,  $f'$  is headed by the unary f-node, but is also linked to the second (and transparent) root node  $\times_b$ . The third f-node,  $f''$  is headed by  $f'$  (and indirectly by  $\times_a$ ), but is also linked to another transparent segment, which is shown as association with  $\times_c$ . Henceforth, I omit the notational distinction among recursive f-nodes, marking them simply as “f”. This proposal only slightly differs from the model developed for prosody and segment-internal feature structure by Morén (2006c, 2007a,c,d, 2008).<sup>2</sup>

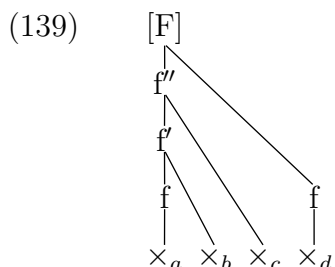

<sup>2</sup>The current model has been developed in collaboration with Bruce Morén-Duolljá.

In (140), we see a slightly more complex representation that involves a trigger ( $\times_1$ ), two targets ( $\times_4, \times_6$ ) and three transparent segments ( $\times_2, \times_3$  and  $\times_5$ ). The trigger is graphically aligned with the highest, non-recursive F-node. The targets are associated with a non-branching f-node. Transparent segments are between the trigger and the two targets. Each of them is a dependent of a binary branching f-node, but is not associated with a non-branching f-node. The elements of the representation are graphically delimited. F-nodes are marked on the highest levels (the top two levels in this particular example), followed by branching f-nodes (the third and the fourth level) and a single level of non-branching f-nodes. This way it is relatively easy to see the different levels of prominence.

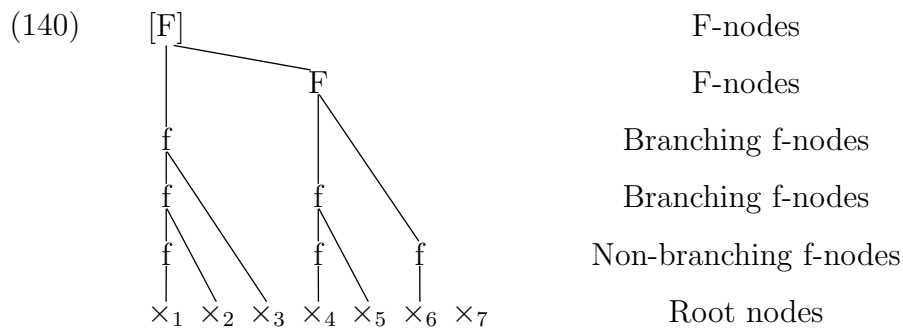

The distinction between the trigger and non-final targets on the one hand and final targets on the other has been so far captured by the distinction between headed segments and non-headed segments. In (141), I define the association via a non-branching f-node “full association” and the association via a branching f-node as dependent association (or d-association). Triggers and targets are fully associated with a feature, while transparent segments are d-associated with a feature. Note also that when [f] is linked to a single root node, this also counts as full association. In other words, when [f] does not spread, it is always fully associated with a root node.

- (141) Two types of associations
- a. Association  
An  $\times_i$  is associated with the feature [f], iff there is an association line between  $\times_i$  and [f].
  - b. Full association  
An  $\times_i$  is fully associated with the feature [f], iff
    - there is an f-node of [f], such that
    - (i) f-node is associated with  $\times_i$
    - and
    - (ii) f-node is not associated with any other  $\times$ .

- c. Dependent association (or d-association)  
 An  $\times_i$  is d-associated with the feature [f], iff
- (i) the statement in (141-a) is true  
     and
  - (ii) the statement in (141-b) is not true.

A simple extension of BDT allows us to distinguish transparent segments from triggers/targets purely representationally. This distinction is in that triggers and targets are heads of f-nodes (and are linked to a non-branching f-node), while transparent segments are not (and are not linked to a non-branching f-node either). The classical notion of association between a feature and a target is retained with a link between a non-branching f-node and a root node. However, the classical notion of association is complemented by links that connect transparent segments. These latter association lines are between a binary branching f-node and a dependent root node.

Extending BDT to transparent segments has a crucial phonological implication, namely that all spreading is always strictly local. No well-formed candidate will contain a segment not linked to a feature, while an autosegment is associated with a preceding root node and a subsequent root node at the same time. This is formalized in the Strict Locality Condition (142). The definition resembles the No Head Lapse condition (120). Similar restrictions are ubiquitous in prosodic theory, and have been previously proposed for other patterns by Kiparsky 1981; Levergood 1984; McCarthy & Prince 1986; Archangeli & Pulleyblank 1994; Myers 1997, among many others. In the current context, Strict Locality Condition is a function of Gen. Gen will never generate skipped configurations (even if present in the input). This is a major modification of classic OT, where skipped configurations are often allowed (Kirchner 1993; Beckman et al. 1995; Itô et al. 1995; Kaun 1995; Ní Chiosáin & Padgett 1997, 2001). Related proposals have been made by some literature. For example, the proponents of Agreement by Correspondence (Hansson 2001; Rose & Walker 2004; McCarthy 2007a) claim that most cases of assimilation are strictly local, whereas consonant harmony is essentially the only exception, and thus involves a rather different mechanism. The current approach goes one step further and claims that *all* assimilation—including consonant harmony—is subject to the Strict Locality Condition (see section 8.5 for further discussion).

- (142) Strict Locality Condition (SLC)  
 Let  $\times_i < \times_j < \times_k$ .  
 If  $\times_i, \times_k$  are associated with the same autosegment [f], then  $\times_j$  must also be associated with that [f].

The Strict Locality Condition makes several robust phonological predictions. First, spreading to a target far from the trigger implies spreading to all intermediate targets. Second, when spreading to only one target is preferred, it will be to the one closest to the trigger. Third, some segments may not be associated with a feature at all, and will effectively block spreading. In sections 5.2.2 and 5.3 I address the first two predictions, while the third is discussed in chapter 6.

### 5.2.2 Constraints

According to the current approach, transparent segments are associated with the spreading feature, although in slightly different terms than targets. This fact alone calls for a refinement of the three constraint families that are involved in feature spreading. I first discuss alignment constraints, followed by faithfulness constraints and constraints on heads.

#### Alignment refined

Recall sections 2.2.2, 3.2.4 and the fact that alignment constraints penalize triplets consisting of a spreading feature which precedes (or is preceded by) a targeted structure within a domain. This is captured by the general constraint template in (26), repeated below in (143).

(143) Featural alignment

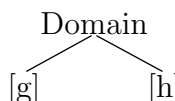
- a.  $*\langle \text{Domain}, [g], [h] \rangle$  / 
- b. Assign a violation mark for every triplet  $\langle \text{Domain}, [g], [h] \rangle$ , iff  
the *Domain* is associated with [g] and [h]  
and  
 $[g] \triangleleft [h]$ .

In this definition, f-precedence plays an important role. The definition in (52)—repeated in (144)—established f-precedence via precedence of root nodes. A necessary requirement to establish an f-precedence relation between two features is the existence of two root nodes, which are exclusively linked to one, but not the other, of the two features. In all other cases, f-precedence cannot be established.

- (144) F-precedence ( $\triangleleft$ )  
 $[g] \triangleleft [h]$ , iff
- (i)  $\exists \times_i$  associated with  $[g]$  but not with  $[h]$ ,  
and
  - (ii)  $\exists \times_j$  associated with  $[h]$  but not with  $[g]$ ,  
and
  - (iii)  $\times_i < \times_j$ .

In the context of the newly introduced distinction between transparent segments and targets, the definition of f-precedence needs to be revised such that it only includes full association of targets, but not dependent association of transparent segments. F-precedence of transparent segments cannot be established. However, before I propose such a modification, I will look at another prediction of alignment constraints.<sup>3</sup>

The constraint in (143) requires that  $[g]$  does not f-precede  $[h]$  within a particular domain. Consider an input, the faithful output of which violates (143). There are various other candidates that satisfy the alignment constraint. One way of satisfying the constraint is to delink  $[g]$  or  $[h]$ . This is an attested pattern—dissimilation (section 3.3.2). Another way of satisfying the constraint is to spread  $[g]$  to all segments containing  $[h]$ . Such a pattern is attested in assimilation. The third possible way of satisfying the constraint is to spread  $[h]$  to segments that contain  $[g]$ . This is yet another case of assimilation. However, the fact that the same alignment constraint can be satisfied either by spreading one feature to segments containing the other, or vice versa, is rather problematic. In particular, the alignment constraints as stated now make a puzzling prediction in which one feature spreads most times, unless it is blocked by some other process, in which case the other feature spreads.

Let us look at a hypothetical example of such a language, called Icelandic' for expositional reasons. Icelandic' resembles Icelandic in that it has regressive rounding harmony triggered by a suffixal  $[\gamma]$ , which targets all  $[a]$ 's (section 4.3). However, rounding never affects the root-initial, stressed  $[a]$ , which always surfaces faithfully. Such a language seems highly likely, since root-initial (in this case also stressed) syllables are more prominent than other syllables, and may be resistant to neutralization. One way of capturing this restriction is by positional faithfulness (Beckman 1997, 1998). The tendency of root-initial syllables to allow more contrast than other syllables is found in many languages. This can be formalized in terms of faithfulness constraints, which outrank the respective markedness constraints and general faithfulness constraints. In (145-a), we see a general IDENT[round] that preserved the input specification for [round]. In (145-b), there is a positional faith-

---

<sup>3</sup>Thanks to John McCarthy for insightful discussion on this point.



fulness constraint that preserves rounding of vowels only in root-initial syllables, as required for Icelandic'.<sup>4</sup>

- (145) a. IDENT-[round]  
 Let  $\times_i \mathfrak{R} \times_o$ .  
 Assign a violation mark, iff  $\times_i$  and  $\times_o$  are not identical with respect to the feature [round].
- b. IDENT- $\sigma_1$ [round] (after Beckman 1997:7)  
 Let  $\times_i \mathfrak{R} \times_o$ . Assign a violation mark, iff
- (i)  $\times_o$  is in the root-initial syllable
  - and
  - (ii)  $\times_i$  and  $\times_o$  are not identical with respect to the feature [round].

In Icelandic', rounding of the root-initial vowel is always preserved, regardless of rounding harmony. This suggests that the positional faithfulness constraint IDENT- $\sigma_1$ [round] (145-b) outranks the alignment constraint. Recall that the alignment constraint sufficient for the of Icelandic is  $^*\omega$ [vowel, round], as in (79). Normally, it is not assumed that vowels spreads, and to make the current argument more clear, I need to use a constraint that targets a feature which does spread. The most obvious choice for this feature is [open], as in Icelandic only /a/, an open vowel, is targeted. The relevant alignment constraint is  $^*\omega$ [open, round], defined in (146). This constraint is similar to the constraint  $^*\omega$ [open, rtr] required in the analysis of Wolof (section 3.2.3). In chapter 3, we have seen that some features prefer spreading to a subset of segments (over other segments), and that this can be captured by alignment constraints. For example, the feature [rtr] generally does not skip open vowels, but it does skip high vowels. Kaun (1995:67) makes a similar observation regarding open vowels in her typological study of rounding harmony: there are no reported languages in which open unrounded vowels are transparent to rounding harmony, but high unrounded vowels are not. However, there are languages with the opposite pattern. Khalkha Mongolian, for example, has rounding harmony in which the high front vowel is transparent (Goldsmith 1985; Svantesson et al. 2005). I will revisit this issue in section 8.4.5. Hence, we can conclude  $^*\omega$ [open, round] is a valid alignment constraint.

- (146)  $^*\text{PWd}[\text{open}, \text{round}]$
- a.  $^*\langle \text{PWd}, [\text{round}], [\text{open}] \rangle$  /  $\begin{array}{c} \text{PWd} \\ \swarrow \quad \searrow \\ [\text{open}] \quad [\text{round}] \end{array}$

---

<sup>4</sup>For a detailed treatment of positional faithfulness see chapter 9.

- b. Assign a violation mark for every triplet  $\langle PWd, [\text{round}], [\text{open}] \rangle$ , iff  
 $PWd$  is associated with  $[\text{round}]$  and  $[\text{open}]$   
 and  
 $[\text{open}] \triangleleft [\text{round}]$ .

The ranking of  $\text{IDENT-}\sigma_1[\text{round}] \gg * \omega[\text{open}, \text{round}]$  is complemented by faithfulness constraints. In Icelandic', the constraints preserving association lines to  $[\text{open}]$ — $\text{MAXLINK}[\text{open}]$  and  $\text{DEPLINK}[\text{open}]$ —outrank the constraint against linking association lines to  $[\text{round}]$ — $\text{DEPLINK}[\text{round}]$ .

Tableau (147) illustrates the ranking on a form containing two open vowel targets and a trigger  $[\gamma]$ . The evaluation is slightly simplified, and excludes consonants. Under the proposed ranking, candidate (b) with spreading to all but the root-initial target wins. Candidate (a) with no spreading loses on alignment. Candidates (c) and (d) satisfy the alignment constraint perfectly, but loose on  $\text{MAXLINK}[\text{open}]$  or the positional faithfulness constraint. The final candidate (e) shows spreading of  $[\text{open}]$  rather than  $[\text{round}]$ . This candidate, too, satisfies the alignment constraint  $* \omega[\text{open}, \text{round}]$  because it is not true that  $[\text{open}]$  f-precedes  $[\text{round}]$ . Recall that one condition for f-precedence is that there is a root node associated with  $[\text{round}]$ , but not  $[\text{open}]$ . Candidate (e) contains no such root node. This demonstrates that alignment may be satisfied by spreading any of the two features. Candidate (d) with total spreading of  $[\text{round}]$  satisfies the alignment constraint just as candidate (e) with total spreading of  $[\text{open}]$ .

(147) Icelandic': /japan-ym/ → [japœnym]

|                  | $\begin{array}{c} [r] \\   \\ / a \ a - y / \\   \   \\ [o] [o] \end{array}$                          | ID- $\sigma_1$ [rd] | MAXLK[op] | * $\omega$ [op,rd] | DEPLK[op] | DEPLK[rd] |
|------------------|-------------------------------------------------------------------------------------------------------|---------------------|-----------|--------------------|-----------|-----------|
| a.               | $\begin{array}{c} [r] \\   \\ a \ a \\   \   \\ [o] [o] \end{array}$                                  |                     |           | **!                |           |           |
| b. $\rightarrow$ | $\begin{array}{c} [R] \\ / \ r \ r \\   \   \\ a \ œ \ y \\   \   \\ [o] [o] \end{array}$             |                     |           | *                  |           | *         |
| c.               | $\begin{array}{c} [R] \\ / \ r \ r \\   \   \\ u \ œ \ y \\   \   \\ [o] \end{array}$                 |                     | *!        |                    |           | *         |
| d.               | $\begin{array}{c} [R] \\ / \ R \ r \ r \\   \   \   \\ œ \ œ \ y \\   \   \   \\ [o] [o] \end{array}$ | *!                  |           |                    |           | **        |
| e.               | $\begin{array}{c} [r] \\   \\ œ \ œ \ y \\   \   \   \\ o \ O \ o \\   \ / \\ [O] \end{array}$        |                     |           | *!                 | **        |           |

Now consider an input with only two vowels, such as the one shown in (148). In Icelandic' we would expect no rounding, while all other features are preserved, as in candidate (a). However, under the same ranking as in (147), candidate (a) fatally violates the alignment constraint, while the competing candidate (d) wins. Candidate (d) has spreading of [open], which does not violate the high ranked MAXLINK[open] constraint.

(148) Icelandic': /barn-ym/ → \*[barnœm] (unattested)

|      | $\begin{array}{c} [r] \\   \\ a - Y \\   \\ [o] \end{array}$                                                | ID- $\sigma_1$ [rd] | MAXLK[op] | * $\omega$ [op,rd] | DEPLK[op] | DEPLK[rd] |
|------|-------------------------------------------------------------------------------------------------------------|---------------------|-----------|--------------------|-----------|-----------|
| a. ☹ | $\begin{array}{c} [r] \\   \\ a \\   \\ [o] \end{array}$                                                    |                     |           | *!                 |           |           |
| b.   | $\begin{array}{c} [R] \\ / \quad \backslash \\ r \quad r \\   \quad   \\ œ \quad Y \\   \\ [o] \end{array}$ | *!                  |           |                    |           | *         |
| c.   | $\begin{array}{c} [r] \\   \\ u \\   \\ Y \end{array}$                                                      |                     | *!        |                    |           |           |
| d. ☞ | $\begin{array}{c} [r] \\   \\ a \\   \\ o \\ / \quad \backslash \\ [O] \quad o \end{array}$                 |                     |           |                    | *         |           |

I have demonstrated that the current version of alignment constraints may interact with other processes or constraints (including positional faithfulness) in a way that triggers spreading of one feature in most circumstances and spreading of the other feature in specific environments, such as when the trigger is next to a target protected by positional faithfulness. To the best of my knowledge, such patterns have not been reported. While the current approach has other constraints to exclude this pattern (such as constraints of feature heads proposed in section 4.2.4), it is problematic that alignment constraints produce pathologies that other approaches do not.

The remedy I am proposing makes use of representational modifications of BDT introduced in this chapter. Recall that I have argued for a distinction between association of a transparent segment and that of a target. Targets are associated with non-branching f-nodes, while transparent segments are associated only with branching f-nodes, which are headed by a target/trigger. This representational distinction between targets and transparent segments has two consequences for all kinds of constraints involved in feature spreading. First, alignment and faithfulness constraints can only be evaluated with respect to full association. In other words, d-association cannot have any influence on these constraints. Second, reference to non-branching nodes rather than autosegments allows for a distinction between

the spreading feature and the targeted structure of alignment constraints. I now look at both modifications in more detail.

First, alignment constraints force spreading to targets, while they remain agnostic about the transparent segments. In other words, alignment constraints are violated by any unassociated segments that contain the targeted structure, but are not violated by any unassociated segments that do not contain the targeted structure. The former are potential targets, while the latter are transparent to spreading. In this chapter, I proposed that targets and transparent segments differ representationally. Only targets contain non-branching f-nodes, while transparent segments do not. This suggests that only non-branching f-nodes are relevant to alignment constraints. In other words, only full association satisfies alignment, while dependent association (or d-association) does not. Clearly, alignment constraints under their current definition do not make this distinction. I propose that alignment constraints be modified to capture this disparity.

This modification comes in the form of a revision to f-precedence. Recall the definition of f-precedence in (144). This definition does not distinguish between the two types of association. In light of the above discussion, such a distinction is actually necessary. In particular, only full association enables establishing f-precedence relations. Dependent association, on the other hand, does not. In (149), I present the definition of f-precedence that makes this explicit.

- (149) F-precedence limited to full association  
 $[g] \triangleleft [h]$ , iff
- (i)  $\exists \times_i$  fully associated (141-b) with  $[g]$  but not with  $[h]$ ,  
and
  - (ii)  $\exists \times_j$  fully associated (141-b) with  $[h]$  but not with  $[g]$ ,  
and
  - (iii)  $\times_i < \times_j$ .

Second, the alignment constraint template in (143) offers no distinction between the spreading feature and the targeted structure. The pathology involving bidirectional alignment of two features seen in (147) and (148) suggests that the spreading feature has a different status than the targeted structure. When the targeted structure is a feature  $[h]$ , what matters is that each instance of an h-node potentially incurs a violation mark, rather than each instance of a feature  $[h]$ . In other words, f-precedence relations should be established between an h-node and an instance of the spreading feature  $[g]$ . This means that the alignment constraint in (143) can be split into two separate constraints.

The first constraint contains  $[g]$  as the spreading feature and  $[h]$  as the targeted structure, as in (150). What this definition has in common with the previously proposed constraint (143) is that it assigns a violation mark for every triplet

\* $\langle \text{Domain}, [g], [h] \rangle$ . However, this definition is upgraded from the old definition in that f-precedence is established on the level of h-nodes rather than on the level of the targeted structure [h]. As long as there is an h-node of a feature [h], which is not associated with [g], the constraint will incur a violation mark. This means that spreading of [g] to all segments fully associated with [h] will satisfy the constraint, since there will be no h-nodes not associated with [g] (by proxy, i.e. via root nodes). On the other hand, spreading of [h] regressively to a segment fully associated with [g] still violates the constraint, since the triggering [h] is not linked to [g]; the h-node of the trigger is still f-preceded by [g]. Observe that the violating triplet  $\langle \text{Domain}, [g], [h] \rangle$  contains two features. This means that each instance of [h] participates in the violating triplet, even if it is associated with multiple h-nodes.

(150) Spreading of [g] that precedes targets with [h]: \*Domain([g], h)

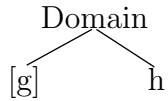
- a. \* $\langle \text{Domain}, [g], [h] \rangle$  / 
- b. Assign a violation mark for every triplet  $\langle \text{Domain}, [g], [h] \rangle$ , iff the *Domain* is associated with [g] and an h-node of [h] and  $[g] \triangleleft h$ .

The second constraint in (151) contains [h] as the spreading feature and [g] as the targeted structure, where [g] f-precedes [h]. This constraint crucially differs from (150) in that this time f-precedence is established between a g-node and an instance of the feature [h]. Furthermore, [h]—and not [g]—is the spreading feature, and the f-precedence relations are reversed. This constraint forces spreading of [h] to all segments containing a g-node, even if [g] is linked to multiple root nodes. Only regressive spreading of [h] to all targets containing a g-node satisfies the constraint in (151), since all root nodes linked to a g-node become linked to [h]. Progressive spreading of [g] does not satisfy the constraint, since spreading of [g] creates new g-nodes, which remain unassociated with [h] via the root node.

(151) Spreading of [h] to all preceding targets with [g]: \*Domain(g, [h])

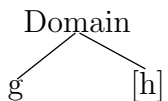
- a. \* $\langle \text{Domain}, [h], [g] \rangle$  / 
- b. Assign a violation mark for every triplet  $\langle \text{Domain}, [h], [g] \rangle$ , iff the *Domain* is associated with [h] and a g-node of [g] and  $g \triangleleft [h]$ .

We have now seen that the representational modification allows us to distinguish two different alignment constraints, even if the triplet contains the same domain and two features. This follows quite naturally from basic findings of chapter 2, in which I argued that feature spreading involves three *different* elements. However, up until this chapter, we have lacked the instrument to distinguish the spreading feature from the targeted structure. With the introduction of hierarchical structure into assimilation, we can now tell apart a single instance of a feature and an individual root node linked to a feature. The spreading feature is evaluated on the level of a feature, while the targeted structure is evaluated on the level of root node. This means that for every triplet consisting of (i) one domain associated with (ii) one feature that precedes (iii) the other feature, there will be two constraints, as in (150) and (151). These two constraints are distinguished by abbreviation as well— $*\text{Domain}([g], h)$  versus  $*\text{Domain}(g, [h])$ . The spreading feature is in square brackets in both cases.

The advantage of this reformulation of alignment constraints is that it allows for a distinction between a spreading feature and a targeted structure. This is directly tied to the hypothetical example discussed above. Recall the Icelandic' rounding harmony, which shows positional faithfulness effects to the initial syllable. The relevant alignment constraint in Icelandic' requires [round] to be the spreading feature, [open] as the targeted structure, and the Prosodic Word as the domain. The relevant constraint is  $*\omega(\text{open}, [\text{round}])$  in (152).

- (152)  $*\omega(\text{open}, [\text{round}])$
- a.  $*\langle \omega, [\text{round}], [\text{open}] \rangle$  /  $\begin{array}{c} \text{PWd} \\ \swarrow \quad \searrow \\ \text{open} \quad [\text{round}] \end{array}$
- b. Assign a violation mark for every triplet  $\langle \text{PWd}, [\text{round}], [\text{open}] \rangle$ , iff  $\text{PWd}$  is associated with [round] and an *open*-node of [open] and  $\text{open} \triangleleft [\text{round}]$ .

The constraint (152) cannot be satisfied by spreading of [open], since this creates new *open*-nodes, which incur additional violation marks. Hence, spreading of [round] is preferred, which was the case in the earlier version of alignment constraints. Tableau (153) shows the effect of the alignment constraint  $*\omega(\text{open}, [\text{round}])$ . This constraint is violated by candidate (d) which won under the constraint  $*\omega[\text{open}, \text{round}]$  in (148). In fact, candidate (d) is harmonically bounded by (a). Other candidates have similar violation marks, and candidate (a) wins. This is a much better result as in the previous version of alignment constraints. The candidate with no spreading from the initial syllable wins regardless of the number of syllables in the root.

(153) Icelandic': /barn-ym/ → [barnym] (likely attested)

|                                                                                      | $\begin{array}{c} [r] \\   \\ a - Y \\   \\ [o] \end{array}$                                                       | ID- $\sigma_1$ [rd] | MAXLK[op] | * $\omega$ (op,[rd]) | DEPLK[op] | DEPLK[rd] |
|--------------------------------------------------------------------------------------|--------------------------------------------------------------------------------------------------------------------|---------------------|-----------|----------------------|-----------|-----------|
| a.  | $\begin{array}{c} [r] \\   \\ a \\   \\ [o] \end{array}$                                                           |                     |           | *                    |           |           |
| b.                                                                                   | $\begin{array}{c} [R] \\ / \quad \backslash \\ r \quad r \\   \quad   \\ \text{œ} \quad Y \\   \\ [o] \end{array}$ | *!                  |           |                      |           | *         |
| c.                                                                                   | $\begin{array}{c} [r] \\   \\ u \\   \\ Y \\   \\ [o] \end{array}$                                                 |                     | *!        |                      |           |           |
| d.                                                                                   | $\begin{array}{c} [r] \\   \\ a \\   \\ o \\ / \quad \backslash \\ [O] \quad o \end{array}$                        |                     |           | *                    | *!        |           |

I have now shown that the revised and very final version of alignment constraints makes better predictions about assimilation processes. In particular, the new versions allow for the distinction between the spreading and the targeted structure, creating twice the number of alignment constraints. The framework allows to capture spreading of any two features independently of one another. In other words, the fact that a particular feature is a targeted structure of one alignment constraint is not related to the same feature being a spreading feature of another constraint. This is directly relevant to the typology of targeted structures, which are tied to a specific spreading feature. One spreading feature has nothing to do with an identical targeted structure of another alignment constraint. Third, alignment is only satisfied by full association of all features involved. Dependent association with the spreading feature does not count as association which would negate f-precedence relations (and hence satisfy the alignment constraint).

### Faithfulness constraints

The second family to be discussed are faithfulness constraints against spreading, DEPLINK[f], as in (41). Recall the Strict Locality Condition in (142) which states that no root node can ever be skipped by a feature. This entails that transparent segments are also associated with the spreading feature, although in different terms than targets. In part I of the thesis, I offered an account of feature spread-



ing assuming only full association. Both alignment constraints and faithfulness constraints can make reference only to full association. They remain agnostic with respect to d-association.

Let us now consider three alternatives. The first one is that alignment and faithfulness constraints could refer to any kind of association. The main prediction of this approach is that transparent segments are always preferred over targets. This is because targets require additional f- and F-nodes, which in turn violate other constraints, including constraints on heads. Such a situation is highly undesirable, since transparent segments are standardly assumed to be a marked situation. In the language of OT, transparent segments violate some markedness constraint that is not violated by targets. Examples of such constraints are NO-GAP[f] (Kirchner 1993; Itô et al. 1995) and EXPRESS[f] (Kisseberth 1994; Cole & Kisseberth 1995a,b; Cassimjee & Kisseberth 1998).

The second alternative is to say that alignment constraints can be satisfied by any kind of association, while faithfulness constraints are violated only by full association. Such an approach suffers from a similar problem as the first alternative, but with a slightly different twist. As we have seen above, when alignment is satisfied by any kind of association, transparent association will be preferred. We know of no other markedness constraint that prefers targets to transparent segments, hence targets would never surface. What makes the situation worse is that targets would additionally violate faithfulness constraints such as DEPLINK[f].

The third alternative is that alignment constraints can be satisfied only by full association, whereas faithfulness constraints are violated by any kind of association. For the most part, this approach makes the right predictions. That is, targets are determined by alignment constraints, and all other segments surface as transparent due to low ranked constraints on heads. The problem arises when we consider the fact that d-association can also be underlying, and that the constraint MAXLINK[f] would be violated by any kind of delinking. If MAXLINK[f] outranks DEPLINK[f], which in turn outranks the alignment constraint, the resulting grammar would retain all d-associated segments. This is clearly a pathology, which is furthermore not predicted by the model I will advance in what follows, namely that faithfulness constraints can see only full association.

The only remaining option is to say that only full association, but not d-association, incurs a violation mark of DEPLINK[f], as in (154). This means that only a segment containing a non-branching f-node violates DEPLINK[f], while a segment associated with a feature via a branching f-node does not. In other words, transparent segments never violate DEPLINK[f].

- (154) DEPLINK[f]  
 Let  $\times_i$  be an input root node and  $\times_o$  its output correspondent. Assign a violation mark, iff  $\times_o$  is fully associated (141-b) with [f] and  $\times_i$  is not.

The constraint  $\text{DEPLINK}[f]$  inhibits full association on a transparent segment, which would otherwise turn it into a target. It turns out that faithfulness constraints are solely responsible for enforcing d-association rather than full association, particularly since we have already seen in section 3.2 that alignment constraints do not penalize transparent segments or non-targets. The only reason why d-association is created in the first place is due to the Strict Locality Condition (142), meaning that there is some available target later in the output.

Tableau (155) shows the evaluations of  $\text{DEPLINK}[f]$  on an input with three segments. Consider that in this case spreading to all segments containing  $[g]$  is preferred. Candidate (a) has no spreading and does not violate  $\text{DEPLINK}[f]$ . Candidate (b) has spreading to the final root node, violating  $\text{DEPLINK}[f]$  once. The intermediate root node is transparent and only d-associated with  $[f]$ . Hence, this root node does not incur a violation of the faithfulness constraint. Candidate (c) has spreading to all three segments. In other words, all root nodes are fully associated with  $[f]$ . Thus, both targets violate  $\text{DEPLINK}[f]$ . Put differently,  $\text{DEPLINK}[f]$  is only violated by full association. Transparent segments are only d-associated with  $[f]$  and do not incur a violation mark of  $\text{DEPLINK}[f]$ .

(155)  $\text{DEPLINK}[f]$  evaluations

|    |                                                                                                                                                                      |                     |
|----|----------------------------------------------------------------------------------------------------------------------------------------------------------------------|---------------------|
|    | $\begin{array}{c} [f] \\   \\ / \times \times \times / \\   \quad   \\ [g] \quad [g] \end{array}$                                                                    | $\text{DEPLINK}[f]$ |
| a. | $\begin{array}{c} [f] \\   \\ \times \times \times \\   \quad   \\ [g] \quad [g] \end{array}$                                                                        |                     |
| b. | $\begin{array}{c} [F] \\ / \quad \backslash \\ f \quad f \\   \quad   \quad   \\ \times \quad \times \quad \times \\   \quad   \quad   \\ [g] \quad [g] \end{array}$ | *                   |
| c. | $\begin{array}{c} [F] \\   \quad \backslash \\ f \quad F \\   \quad   \quad   \\ \times \quad \times \quad \times \\   \quad   \quad   \\ [g] \quad [g] \end{array}$ | **                  |

To put it in a different perspective, BDT distinguishes different types of association. Some association lines bare stronger prominence than the other.  $\text{DEPLINK}[f]$  constraints cannot detect whether a segment is d-associated, but can detect whether a segment is fully associated. Because transparent segments are d-associated, they

are not subject to  $\text{DEPLINK}[f]$  constraints. On the other hand, full association is penalized by  $\text{DEPLINK}[f]$ . Such a distinction is also captured by various constraints in other theories that assume different representation of transparent segments and targets (Turbidity Theory, Colored Containment).

The committee points out that the standard assumption is that transparent segments are more marked than targets, and that this is not the case in the current approach, because transparent segments and targets fare equally on faithfulness constraints (and as we will see, this is also true for constraints on heads and feature co-occurrence constraints). My reply is that other approaches treat all transparent segments as equally marked. We have seen in section 3 that this should not be the case. Instead, transparency shows implicational properties. For example, transparent vowels in RTR harmony imply transparent consonants (as in Wolof), but not vice versa. In the current approach, this effect is achieved by alignment constraint typology, and in this sense some transparent segments are more marked than others because of alignment constraint violations. For example, transparent open vowels (but not targets) in RTR harmony incur violation marks of  $*\omega(\text{open}, [\text{rtr}])$ ,  $*\omega(\text{vowel}, [\text{rtr}])$ , and  $*\omega(\times, [\text{rtr}])$ , whereas transparent consonants violate only the latter constraint. Thus, while transparent segments in BDT are not equally marked, they *are* marked, and this is because of alignment constraints. What is more, no constraint can exclude a single segment from the set of targets, and this is a good prediction.

The conclusions regarding  $\text{DEPLINK}[f]$  may be extended to other constraints that refer to association lines. In particular,  $\text{MAXLINK}[f]$  is only satisfied if the full association in the input is preserved in the output. This means that an underlying trigger surfacing as either transparent or not associated in the output violates  $\text{MAXLINK}[f]$ . In short, faithfulness constraints to association lines need no modification: only full targets violate these constraints, which is exactly the situation in classical autosegmental representations. Hence, all typologies and restrictions based on alignment and faithfulness constraints in chapter 3 remain intact.

### Constraints on heads

Constraints on feature heads were introduced in section 4.2.4. These constraints penalize heads of one feature that are also associated with another feature. In BDT, a feature head is defined as a root node. Any binary branching feature node is associated with exactly one head (85). In this chapter, I extend association to transparent segments. Transparent segments differ from targets in that they are not associated with a non-branching feature node. Instead, they are associated with a branching feature node that is headed by a trigger or a target. Such a representation of transparent segments has two implications for the constraints on heads.

First, transparent segments create additional feature domains. These domains are headed by a preceding trigger or target. The definition of headedness in (85) states that headedness is a property of an individual root node. However, this definition was clear in a version of BDT that did not make any reference to transparent segments. In the previous version, each root node could be a head of maximally one binary feature domain of a unidirectional assimilation pattern. This is because in each binary domain, the head element is never recursive. In contrast, the dependent element of one domain could be binary branching itself, leading to another head. The proposed extension of binarity to transparent segments leads to recursive domains on the headed element itself. Each transparent segment requires its own domain and a head on the preceding trigger or target. For example, a trigger followed by a target and two intermediate transparent segments will be a head of three domains: (i) one domain links the trigger with the target, (ii) another domain links the trigger with the first transparent segment and (iii) the final domain links the trigger with the second transparent segment. However, I retain the notion that headedness is a property of a root node, as in (85). This means that it does not matter whether a particular root node is a head of one or multiple recursive domains. All that matters is that there is at least one domain that has a head element linked to a particular root node. Hence, transparent segments after most targets have no effect on headedness of those targets, because they are already headed. The only position when transparent segments do affect headedness is when they come after the final target. In this case, the final target becomes a head of the relevant spreading feature. I will show that such headed final targets violate some low ranked constraint on heads and do not improve on any other constraint (when a constraint on heads is ranked above the relevant alignment constraint, we get icy targets). Consequently, transparency after the final target is never preferred.

Second, transparent segments are directly associated with a feature node that may be a headed element of a higher domain. This suggests that transparent segments can be themselves heads of a feature. That is, both full and dependent association are relevant when it comes to constraints on heads, which may be violated by transparent segments just as they are by targets. In other words, constraints on heads never prefer transparent segments over targets. This second effect will play a crucial role in the analysis of Icelandic u-umlaut below.

The upgraded BDT thus requires a more precise definition of heads. Recall the definition of feature heads in (85). The preliminary definition states that for any two root nodes linked to the same (binary branching) feature node, one is the head of that feature. The old definition was sufficient in a model that assumed that heads are never recursive. More specifically, a head element of a node could not be linked to another headed binary branching node. As we have just seen, transparent

segments are also associated with a feature and require their own binary domains. These domains are headed by a preceding fully associated segment (a trigger or a target). This creates a novel situation in which one head is recursively the head of on another head. Hence, the old definition of feature heads is no longer sufficient. The new and final definition in (156), takes into account this new factor. First, feature nodes themselves can be headed (156-a). Second, headedness of a feature node permeates through to any associated nodes, but headedness is ultimately determined at the root node level (156-b).

- (156) Feature head
- a. Iff  $f\text{-node}_i$  and  $f\text{-node}_j$  are associated with the same node of the feature  $[f]$ , exactly one of them will be a head.
  - b. If  $f\text{-node}_k$  is a head of  $[f]$ , all root nodes associated with  $f\text{-node}_k$  are heads of  $[f]$ .

One direct consequence of this new definition is that all but one root nodes associated with a feature will be heads of that feature, even if they are only d-associated (transparent). This is in line with No Head Lapse (120).

Next, the definition of constraints on heads in (89)—repeated in (157)—also needs a clarification. Observe that any association violates the constraint. This means that both full association (with a target) and d-association (with a transparent segment) can satisfy the condition in (157-a).

- (157)  $*[F\ g]$
- a. Assign a violation mark for every root node  $\times$ , iff  $\times$  is a Head of a feature  $[f]$  and  $\times$  is associated with  $[g]$ .
  - b.  $* \begin{array}{c} [F] \\ | \quad \diagdown \\ \times \quad \times \\ | \\ [g] \end{array}$

The penalized structure in (157-b) is representative of a larger class of violating configurations. The constraint is violated as long as there is a binary branching node of  $[f]$ , headed by a root node that is also associated with  $[g]$ . This becomes more apparent if we consider the candidates in (158). Candidate (a) has no spreading and does not violate  $*[F\ g]$ . Candidates (b) and (c) have spreading of  $[f]$ , but the headed node is not associated with  $[g]$ . Candidate (d) has spreading of  $[g]$ . Since this candidate has no head of  $[f]$ , the constraint is not violated. This demonstrates that the constraint  $*[F\ g]$  is asymmetrical: it penalizes heads of  $[f]$ , but not heads of  $[g]$ . The remaining candidates (e-j) all violate the constraint on heads. Candidate (e) has spreading of  $[f]$ , which creates a head on the first root node, which is also associated with  $[g]$ . Candidate (f) is a mirror version of (e). The

constraint on heads is not sensitive to directionality and is equally violated by (e) and (f). Candidate (g) has the second feature on both root nodes. However, the fact that the second root node is associated with [g] is irrelevant, because that root node is not a head of [f].

The remaining three candidates (h–j) have one or more transparent segments. Candidate (h) has a transparent second root node. This creates another binary branching f-node, which is headed by the first root node. However, that root node is already a trigger and hence a head that violates \*[F g]. That is, no single root node can violate a constraint on heads more than once (unless spreading is bidirectional), even if it is a head of more than one recursive binary domain. Candidate (i) differs from the previous candidate in that the transparent segment also contains [g]. This segment is linked to an f-node, and it is not a head of that domain. At the same time, that f-node is linked to a non-recursive F-node and it is headed. Given the definition in (156), a root node linked to a headed f-node is a head itself. This applies to both the first and the second root nodes. Both root nodes violate the constraint. This suggests that a constraint on heads \*[F g] never prefers skipping of segments containing [g]. This will be shown to be directly relevant to Icelandic in section 5.3. Finally, candidate (j) has four segments, of which the second and the fourth are transparent. The first root node is identical to most previous candidates and violates \*[F g]. The third root node,  $\times_3$ , is a final target, but has a subsequent transparent segment. The final transparent segment requires a binary branching f-node, which is headed by  $\times_3$ . It is for this reason that  $\times_3$  also violates \*[F g]. The transparent segments are not associated with [g], and cannot violate \*[F g].

(158)  $*[F g]$  evaluations

|                                                                                                                                                                                             | $*[F g]$            |
|---------------------------------------------------------------------------------------------------------------------------------------------------------------------------------------------|---------------------|
| a. $\begin{array}{c} [f] \\   \\ \times_1 \times_2 \\   \quad   \\ [g] \quad [g] \end{array}$                                                                                               |                     |
| b. $\begin{array}{c} [F] \\   \quad   \\ f \quad f \\   \quad   \\ \times_1 \times_2 \end{array}$                                                                                           |                     |
| c. $\begin{array}{c} [F] \\   \quad   \\ f \quad f \\   \quad   \\ \times_1 \times_2 \\   \\ [g] \end{array}$                                                                               |                     |
| d. $\begin{array}{c} [f] \\   \quad   \\ \times_1 \times_2 \\   \quad   \\ g \quad g \\   \quad   \\ [G] \end{array}$                                                                       |                     |
| e. $\begin{array}{c} [F] \\   \quad   \\ f \quad f \\   \quad   \\ \times_1 \times_2 \\   \\ [g] \end{array}$                                                                               | $\times_1$          |
| f. $\begin{array}{c} [F] \\   \quad   \\ f \quad f \\   \quad   \\ \times_1 \times_2 \\   \\ [g] \end{array}$                                                                               | $\times_2$          |
| g. $\begin{array}{c} [F] \\   \quad   \\ f \quad f \\   \quad   \\ \times_1 \times_2 \\   \quad   \\ [g] \quad [g] \end{array}$                                                             | $\times_1$          |
| h. $\begin{array}{c} [F] \\   \quad   \quad   \\ f \quad f \quad f \\   \quad   \quad   \\ \times_1 \times_2 \times_3 \times_4 \\   \quad   \\ [g] \quad [g] \end{array}$                   | $\times_1$          |
| i. $\begin{array}{c} [F] \\   \quad   \quad   \\ f \quad f \quad f \\   \quad   \quad   \\ \times_1 \times_2 \times_3 \times_4 \\   \quad   \quad   \\ [g] \quad [g] \quad [g] \end{array}$ | $\times_1 \times_2$ |
| j. $\begin{array}{c} [F] \\   \quad   \quad   \\ f \quad f \quad f \\   \quad   \quad   \\ \times_1 \times_2 \times_3 \times_4 \\   \quad   \\ [g] \quad [g] \end{array}$                   | $\times_1 \times_3$ |

The evaluations in (158) show several things. First, constraints on heads are not directional. Second, root nodes that are fully associated or d-associated with both relevant features can violate a constraint on heads. Put differently, targets or transparent segments may violate a constraint on heads. In the following section, I demonstrate that constraints on heads never prefer transparent segments over targets. Third, constraints on heads are asymmetrical. A constraint  $*[F\ g]$  has different effects than  $*[G\ f]$ . Fourth, transparent segments also result in heads on preceding targets or triggers, which means that the final targets may also violate a constraint on heads, but only if transparent segments follow. We will see in the next section that such candidates are never optimal.

This concludes the discussion of representations of transparent segments and the constraints involved with them. I have shown that transparent segments are like targets, because they are associated with the spreading feature. However, they are also formally different from targets, because the association lines are not equivalent. Targets are fully associated with the relevant feature, while transparent segments are only d-associated. These differences may be formalized in terms of feature nodes. Targets are directly associated with a non-branching feature node, while transparent segments are directly associated to a binary branching feature node. This representational difference is referred to by constraints. Alignment constraints can only be satisfied by non-branching nodes. Faithfulness constraints are only violated by non-branching nodes. This retains the notion of alignment and faithfulness built up in the previous chapters. On the other hand, constraints on heads are violated equally by transparent segments and targets.

### 5.2.3 Transparency

To make the scope of these modifications explicit, let us briefly review the difference between different types of segments in assimilation. Recall the full representation of spreading in (140), which is slightly modified, and repeated in (159) for convenience. We see seven root nodes and one instance of  $[f]$ . The trigger is the leftmost root node  $\times_1$ , which is indicated by its alignment to the highest, non-recursive feature node. Two other root nodes,  $\times_4$  and  $\times_7$ , are targets. Triggers and targets are linked to the feature via a non-branching f-node. In contrast, transparent segments ( $\times_2$ ,  $\times_3$  and  $\times_5$ ) are not linked to a non-branching f-node. Instead, they are linked to the feature via a binary branching node headed by a trigger or the first target. The final root node  $\times_7$  is not a target nor transparent because it is not associated with  $[f]$ . There are two possibilities for this segment. One is that it is a blocker and cannot be associated with  $[f]$ . Another option is that it is simply a segment beyond the final target. As I will show below, such a segment could at least hypothetically be transparent or a target, too. However, the constraints will prefer no association at all rather than dependent or full association.



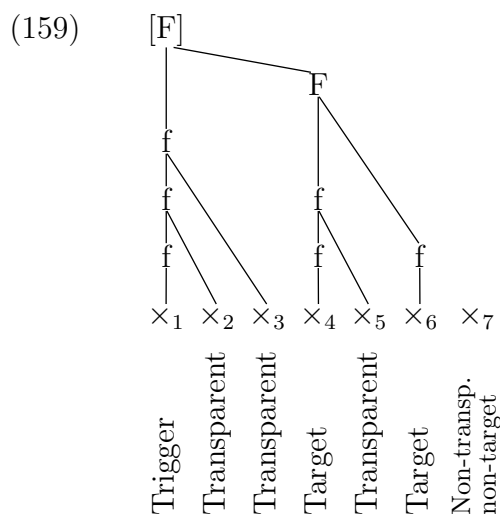

I will consider three cases of transparency in vowel harmony. The first two patterns involve the selection of one target over all other available targets. Up to this chapter, no proposed constraint discriminated among identical targets within a domain. As demonstrated in section 5.1, the alignment constraint is equally satisfied by spreading to any target, which fares equally on faithfulness. I now show that the extension of BDT to transparent segments is a device that prefers one target over all others. By default, the target closest to the trigger is selected. The idea is that transparent segments present a marked structure, and having less or no transparent segments is better than having more transparent segments. Given the fact that a candidate showing spreading to one target fares equally on alignment and faithfulness, spreading to the closest target is preferred by constraints on heads alone.

The typical case of spreading to one target is Icelandic, which is discussed in section 5.3. In Icelandic, the closest open vowel is always targeted. Section 5.4 presents a case of lowering harmony in c'Lela which constitutes an apparent counterexample. In c'Lela spreading to the farthest target is found. However, the c'Lela data actually show that what matters is total alignment with the word edge rather than the position with respect to the trigger. This situation can be formalized by a high ranked alignment constraint that selects a single target. Spreading to other targets is inhibited by faithfulness constraints. This shows that a high ranked alignment constraint will determine the class of targets. A low ranked faithfulness constraint will inhibit spreading to all other segments.

The third case of vowel harmony presents an intermediate situation in which some segments are transparent while others are not. Although similar patterns have been examined to some degree in part I, a closer examination is needed in light of the revised representations. In section 5.5 I analyze Finnish front/back harmony, in which transparent segments form a natural class but targets do not.

I show that such patterns can be accounted for by multiple alignment constraints ranked above `DEPLINK[f]`. This allows for a formalization of the relationship between alignment constraints and transparent segments.

### 5.3 Icelandic

In this section, I will show the effects of all three constraint families in light of the revised version of BDT. Recall section 5.1 and the Icelandic u-umlaut pattern. I take Icelandic u-umlaut as representative of a larger class of cases which show that features spread to segments closest to triggers, all other things being equal. This gives an insight into how feature spreading works. Recall also tableau (135) and the fact that alignment and faithfulness constraints do not distinguish among multiple identical targets, as long as they are within a domain. In section 5.2, I extended spreading to transparent segments. This allows for several things. First, transparent segments differ representationally from targets and entirely non-associated segments. Second, constraints may distinguish these different types of segments from one another. This is directly tied to Icelandic u-umlaut, which involves only one target. When several identical targets are available, the one closest to the trigger is actually selected. The closest target is also the one that results in the fewest transparent segments. According to the formalism developed in the previous section, transparent segments violate a constraint on heads. At the same time, there is no constraint that prefers transparent segments. Thus, if there is no other constraint that prefers spreading to a particular target, spreading to the closest of all available targets is preferred.

In (160), I demonstrate this point for Icelandic u-umlaut. Parallel to (135), I show four candidates: (a) is fully faithful, (b) shows spreading to the closest (open) vowel, (c) shows spreading to the root-initial vowel while the other vowel is transparent, and (d) has rounding of both vowels. In addition, I include candidate (e), which has a transparent vowel preceding the target, and candidate (f) with skipped segments. For the most part, the representations are consistent with BDT: full targets have a non-branching round-node, while transparent segments are linked to the feature [round] via a higher binary branching round-node. One target involves a head of [round] on the trigger, while two targets—as in candidate (d)—require two heads. Furthermore, a transparent segment also creates a head on a trigger or a target. This is made obvious by candidate (e) in which the middle vowel has a head because it is followed by at least one transparent segment. This candidate, too, has a feature head on the middle vowel. Finally, transparent segments are also heads themselves. Thus, candidate (c) has a head on the middle vowel. As a matter of convention, transparent segments are transcribed as if they lack the spreading feature.

(160) japœnym ‘Japanese.DAT.PL’

|                                                                                                                                                                                                       |          |                       |             |
|-------------------------------------------------------------------------------------------------------------------------------------------------------------------------------------------------------|----------|-----------------------|-------------|
| $\begin{array}{c} \text{[rd]} \\ / \text{j a p a n - } \underset{\downarrow}{\text{Y}} \text{ m} / \\ \text{[op]} \text{ [op]} \end{array}$                                                           | *[RD op] | * $\omega$ (vow,[rd]) | DEPLINK[rd] |
| a. $\begin{array}{c} \text{[rd]} \\ \text{j a p a n } \underset{\downarrow}{\text{Y}} \text{ m} \\ \text{[op]} \text{ [op]} \end{array}$                                                              |          | **!                   |             |
| b. $\begin{array}{c} \text{[RD]} \\ \text{rd} \\ \text{rd} \text{ rd} \\ \text{j a p œ n } \underset{\downarrow}{\text{Y}} \text{ m} \\ \text{[op]} \text{ [op]} \end{array}$                         |          | *                     | *           |
| c. $\begin{array}{c} \text{[RD]} \\ \text{rd} \\ \text{rd} \text{ rd} \\ \text{rd} \text{ rd} \\ \text{j œ p a n } \underset{\downarrow}{\text{Y}} \text{ m} \\ \text{[op]} \text{ [op]} \end{array}$ | *!       | *                     | *           |
| d. $\begin{array}{c} \text{[RD]} \\ \text{RD} \\ \text{rd} \text{ rd} \\ \text{rd} \text{ rd} \\ \text{j œ p œ n } \underset{\downarrow}{\text{Y}} \text{ m} \\ \text{[op]} \text{ [op]} \end{array}$ | *!       |                       | **          |
| e. $\begin{array}{c} \text{[RD]} \\ \text{rd} \\ \text{rd} \text{ rd} \\ \text{rd} \text{ rd} \\ \text{j a p œ n } \underset{\downarrow}{\text{Y}} \text{ m} \\ \text{[op]} \text{ [op]} \end{array}$ | *!       | *                     | *           |
| f. $\begin{array}{c} \text{[RD]} \\ \text{rd} \text{ rd} \\ \text{j œ p a n } \underset{\downarrow}{\text{Y}} \text{ m} \\ \text{[op]} \text{ [op]} \end{array}$                                      | Ruled    | out by                | SLC (142)!  |

If we compare (135) with (160), we see that the constraints appear to be very similar, but are not identical. More specifically, the alignment and faithfulness

constraints in (160) refer only to full association, while \*[ROUND open] may be violated by a target or a transparent segment. The evaluation of the alignment and faithfulness constraints is identical in both tableaux, although their definitions have been modified. First, the alignment constraint has a built-in distinction between the spreading feature and the targeted structure. The alignment constraint \* $\omega$ (vow,[rd]) cannot be satisfied by changing a consonant to a vowel, which is not the case in any of the candidates. Second, the faithfulness constraint DEPLINK[round] is only violated by a non-branching round-node linked to targets, while transparent segments cannot violate it, which is parallel to the original proposal. Neither of the two constraints can see dependent associations to transparent segments.

The crucial difference is in the constraint \*[ROUND open] that can be violated by transparent segments and targets alike. The candidates (b) and (c) differ in terms of the constraint on heads. Candidate (b) does not violate \*[ROUND open], because the candidate has no heads of [round]—on an open vowel. Candidate (c) violates it once on the transparent [a]. Recall that a feature head is any segment that is associated to a headed node of a feature. Transparent [a] in candidate (c) meets this requirement. That is, this segment is associated with [open] and is also a head of [round], since it is linked to a round-node, which is headed. This shows that the constraint on heads effectively prefers spreading to the closest (icy) target.

The current approach, however, makes an even stronger prediction. Under no ranking of *these constraints* can an icy target other than the closest to the trigger win. This is evident when we compare candidates (160-b) and (c). The winning candidate (b) has a subset of violation marks incurred by candidate (c). In other words, these constraints will never prefer candidate (c) with a distant target to candidate (b) with a closer target.<sup>5</sup> This is yet another welcome result, since spreading to a distant target always implies spreading to a featurally and prosodically identical local target, but not vice versa.

Next, consider candidate (e), which has one transparent open vowel, followed by a target open vowel. This candidate violates all constraints that the harmonically bounded candidate (c) does. The constraint is violated by the second vowel, even though there is no full spreading from that vowel. Recall that transparent segments require a feature node, which is headed by a target or a trigger. The second vowel is a target that contains such a head. Hence, this vowel violates \*[ROUND open]. In other words, constraints on heads additionally limit transparent segments after the final target. Candidate (e) is harmonically bounded by (b). Finally, candidate (f) shows a gapped configuration rather than one containing d-associated transparent

---

<sup>5</sup>As we will see in the next section, candidates like (c) are cross-linguistically attested. However, this is due to other constraints.

segments. This candidate is excluded by the Strict Locality Condition (142), and will never be generated.

To summarize, constraints on heads are violated equally by transparent segments and targets. This has two direct consequences. First, when a constraint on heads is outranked by an alignment constraint, spreading to the closest icy target is preferred. Given these constraints, under no ranking can a candidate with a single distant target win over a candidate with a local target. Second, constraints on heads penalize candidates with a target that is linked to consecutive transparent segments. This shows that transparency is limited to the position between the trigger and target. The current approach excludes all these unattested patterns.

## 5.4 C'Lela

In this section, I examine a language that seems to contradict the conclusions based on Icelandic. In particular, this language prefers spreading to a distant target, but not to a local one. This appears to be a serious challenge to the proposed representations of transparency, which imply that the closest target is always preferred. Upon closer examination, however, it turns out that the language discussed in this section is not an exception. In particular, what matters is completely aligning a feature with a domain edge. Thus, the furthest target is preferred over any other. The constraint preferring perfect alignment trumps effects of other constraints. The low ranked faithfulness constraints prefer transparent segments over targets. Thus, c'Lela is no different from other cases of transparency in that alignment alone determines the class of transparent segments.

### 5.4.1 Data

C'Lela, a Niger-Congo language spoken in Nigeria, exhibits height harmony. Harmony applies within a root, and from a root to a suffix (Dettweiler 2000; Pulleyblank 2002; Archangeli & Pulleyblank 2007; Michel to appear). In (161), we see that a high root vowel is followed by a high suffix vowel, while a non-high root vowel is followed by a non-high suffix vowel. This is true across all lexical categories; I present the data for nouns (161-a) and adjectives (161-b).

|       |                                                   |               |                             |               |
|-------|---------------------------------------------------|---------------|-----------------------------|---------------|
| (161) | C'Lela lowering harmony (Dettweiler 2000:8,11–13) |               |                             |               |
| a.    | in- <u>m</u> i                                    | 'my mother'   | cet- <u>m</u> e             | 'my father'   |
|       | in- <u>v</u> u                                    | 'your mother' | cet- <u>v</u> o             | 'your father' |
|       | in- <u>u</u>                                      | 'her mother'  | cet- <u>o</u>               | 'her father'  |
|       | h <u>i</u> n- <u>u</u>                            | 'his sibling' | waar- <u>o</u>              | 'his child'   |
| b.    | zis- <u>i</u>                                     | 'long'        | rek- <u>e</u>               | 'small'       |
|       | rim- <u>u</u>                                     | 'black'       | g <sup>j</sup> ɔz- <u>o</u> | 'red'         |

In the languages analyzed so far, multiple affixes behave the same. Spreading to one of them implies spreading to all of them. However, this is not the case in c'Lela. In (162-a), we see that when a high root vowel is followed by several suffixes, all may contain a high vowel. However, when the root vowel is non-high, only one of the suffixes is also non-high. When two suffixes follow, only the final suffix is non-high, while the intermediate suffix vowel remains high. This is complemented by the data in (162-b), which show that when a suffix contains more than one vowel, only the rightmost one alternates. It could be seen that c'Lela shows spreading of the feature [open] from a root to the final suffix vowel, while all other intermediate suffix vowels are skipped. I have used the feature [open] in other languages. In Icelandic, for example, all non-high vowels have this feature (sections 4.1, 4.3, 5.1 and 5.3). The same is true for Wolof (section 3.2.3). I have no reason to assume a different specification here. All non-high vowels are [open] in c'Lela.

|       |                                                 |             |                                 |                 |
|-------|-------------------------------------------------|-------------|---------------------------------|-----------------|
| (162) | C'Lela lowering harmony (Dettweiler 2000:11–13) |             |                                 |                 |
| a.    | zis-i                                           | 'long'      | zis- <u>i</u> -ni               | 'long.I CLASS'  |
|       | rim-u                                           | 'black'     | rim- <u>u</u> -ni               | 'black.U CLASS' |
|       | rek-e                                           | 'small'     | rek- <u>i</u> -ne               | 'small.I CLASS' |
|       | g <sup>j</sup> ɔz- <u>o</u>                     | 'red'       | g <sup>j</sup> ɔz- <u>u</u> -ne | 'red.U CLASS'   |
| b.    | sip- <u>i</u> n                                 | 'grab.PERF' | ɛp- <u>i</u> ne                 | 'bite.PERF'     |
|       | buz- <u>i</u> n                                 | 'chase'     | bat- <u>i</u> ne                | 'release'       |

To summarize, c'Lela has harmony that involves the feature [open] that targets the rightmost vowel within a word. All other vowels and consonants are transparent. In what follows, I will show that c'Lela is identical to other cases of transparency analyzed so far in that the alignment constraint solely determines targets, while the rest of the segments are non-targets.

### 5.4.2 Analysis

A process targeting the final rather than the closest suffix vowel is troubling in light of the current proposal. The vast majority of known assimilation patterns prefer closer targets to distant targets. This is most apparent in processes that

affect a single target, such as the Icelandic u-umlaut (section 5.3). The extension of BDT to transparent segments restricts spreading to the closest target. The limitation to one target rather than multiple targets, however, is an independent variable. Such a restriction is enforced by a high ranked markedness constraint on feature heads. This constraint does not seem to be active in c'Lela. Instead, another markedness constraint is active. The relevant constraint prefers spreading to the rightmost vowel only. This constraint differs from the alignment constraints proposed so far in that only the final target determines whether the constraint is violated or not. In other words, spreading to any non-final vowel does not incur fewer violation marks than no spreading at all. This situation resembles other alignment constraints in that what matters is spreading a feature to an edge of a domain. However, this alignment constraint is only satisfied by spreading to the final vowel, which is unlike any previously discussed alignment constraints.

As we have seen, alignment constraints in this thesis are based on the proposal by Hyde (2008). In (22), I presented one type of such a constraint, which Hyde calls *same edge* and *distance sensitive*. Distance sensitive constraints have three variables: two dependent categories in a precedence relation, which are both associated with another category. In the context of assimilation, these three categories are the spreading feature, the targeted structure and the domain (section 2). However, Hyde (2008) also proposes several other types of constraints, which are all needed for various prosodic phenomena. One such type is distance *insensitive* constraints. Unlike distance *sensitive* constraints, which prefer the positions closer to the edge than ones further from the edge, distance insensitive constraints are satisfied only by perfect alignment to the edge; spreading to any other position does not affect the evaluation.

Recall that distance sensitive alignment constraints, such as the ones used so far, are violated by triplets of categories. Distance *insensitive* constraints, on the other hand, are violated by ordered *pairs* of categories. In the context of assimilation, distance insensitive constraints do not have a targeted structure as a part of the triplet. Instead they are violated by pairs (Domain, Spreading Feature). This means that for each spreading feature, the constraint incurs maximally one violation mark (as long as spreading remains within the domain). The second modification I make is specific to f-precedence. Recall that in distance sensitive constraints, f-precedence is established between a spreading feature and a targeted feature node. In distance insensitive constraints, on the other hand, f-precedence is established between spreading and targeted feature nodes. Furthermore, all spreading feature nodes act as a chunk in that the constraint is violated only if all spreading feature nodes are in some f-precedence relation. Associating the edgemoost target will never violate the constraint, because at least one spreading feature node will not be in a f-precedence relationship with the targeted structure.

Conversely, not associating the edgmost target with the spreading feature will always violate some distance insensitive constraint.

Further recall the definition of the alignment constraint  $*\text{Domain}([g], h)$  in (150), which prefers spreading of  $[g]$  to all following root nodes containing  $[h]$ . This definition can be modified to prefer spreading to the final  $[h]$  only. The new, distance insensitive, constraint in (163) contains only one violating pair rather than one triplet. The targeted structure is not included as a part of the violating n-tuple. Furthermore, all  $g$ -nodes need to  $f$ -precede the  $h$ -node to violate the constraint. In all other regards, the constraint is equivalent to the distance sensitive constraint.

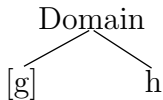
- (163) Spreading of  $[g]$  to the final target  $[h]$
- a.  $*\langle \text{Domain}, [g] \rangle$  / 
- b. Assign a violation mark for every pair  $\langle \text{Domain}, [g] \rangle$ , iff  
the *Domain* is associated with  $g$ -nodes of  $[g]$  and an  $h$ -node of  
 $[h]$   
and  
all  $g \triangleleft h$ .

The omission of  $[h]$  as the member of the violating ordered set in (163) has a profound effect. Consider, for example, one instance of  $[g]$  linked to a root node which is followed by four root nodes fully associated with  $[h]$  within the relevant domain. The distance sensitive constraint  $*\text{Domain}([g], h)$  in (150) is violated four times as there are four different triplets, each containing its own  $h$ -node. The distance insensitive constraint in (163), on the other hand, is only violated once, since there is only one pair of the domain and  $[g]$ . All that matters is that there is at least a single  $[h]$  which follows root nodes fully associated with  $[g]$ .

Note that the final condition in (163) is “all  $g \triangleleft h$  rather than “[ $g$ ]  $\triangleleft$   $h$ ” as it is in the distance sensitive constraint  $*\text{Domain}([g], h)$  in (150). This modification is necessary, since otherwise spreading to all root nodes would be preferred. Consider again one instance of  $[g]$  linked to a root node which is followed by four root nodes fully associated with  $[h]$  within the relevant domain. In this case, the condition  $[g] \triangleleft h$  is met four times, once by each target. However, since the violation marks are assigned at the level of the spreading feature, the constraint in (163) would be violated only once. Spreading  $[g]$  only to the final target only would still meet the condition  $[g] \triangleleft h$  twice (once for each skipped root node). On the other hand, the condition requiring all  $g \triangleleft h$  is not met by the skipped configuration, and the constraint is not violated. In short, the distance insensitive constraint will be violated only by not spreading to the final target, but cannot be violated by not spreading to any other root node.



The distance insensitive alignment constraints need to be extended to feature spreading. In c'Lela, we see spreading of [open] from the root to the final vowel. The distance insensitive constraint requires the rightmost vowel to be [open]. The template in (163) can be filled in such that it becomes relevant to c'Lela. The constraint FINALOPENV in (164) is violated by an instance of [open] f-precedes a vowel, within a prosodic word. Other similar constraints with other features may also be required, but I will postpone this discussion until the end of this section.

(164) FINALOPENV

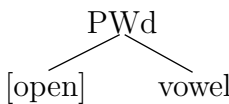
- a. \*⟨PWd, [open]⟩ / 
- b. Assign a violation mark for every pair ⟨PWd, [open]⟩, iff  
*PWd* is associated with *open*-nodes of [open] and a *vowel*  
 and  
 all *open*  $\triangleleft$  *vowel*.

The constraint in (164) outranks the faithfulness constraint against spreading DEPLINK[open]. This is parallel to the Icelandic ranking in (160). The ranking is shown for a single input containing two targets in tableau (165). Candidate (a) has no spreading and violates the alignment constraint FINALOPENV, which requires that the feature [open] is fully associated with the final vowel. This constraint is also violated by candidate (b) that has spreading of [open] to the closest vowel. A similar candidate wins in Icelandic, where a different markedness constraint is ranked highest. The winning candidate (c) contains full association between [open] and the final vowel. This candidate violates DEPLINK[open] once, because it contains one more full association in the output compared to the input. Candidate (d) has spreading to both vowels. While this candidate satisfies the alignment constraint FINALOPENV, it violates the next highest constraint, DEPLINK[open] twice.

Candidate (e) is well-formed with respect to the Strict Locality Condition (142), and shows d-association to all root nodes to the right. This candidate does not satisfy the alignment constraint. This is because alignment can be satisfied only by full association, as discussed in section 5.2.2. This type of candidate will always be harmonically bounded by candidate (a) with no spreading, since d-association does not satisfy any markedness constraints, but always violates some constraint on heads. Here, \*[OPEN vowel] is the relevant constraint on heads, and is ranked lowest. Con contains all combinations of different features in constraints on heads, which means that any trigger followed solely by transparent segments will violate at least one of them. Since there is no constraint preferring transparent segments, they will surface only between a trigger and a target, as required by the Strict

Locality Condition. The remaining candidate (f) fatally violates the dominant faithfulness constraint MAXLk[open], although it satisfies all other constraints. In particular, it also vacuously satisfies the alignment constraint.

(165) rekine ‘small.I CLASS’

|                                                                                        | [op]<br>/ r e k - i - n i /                    | MAXLk[op] | FINALOPENV | DEPLk[op] | *[OP vow] |
|----------------------------------------------------------------------------------------|------------------------------------------------|-----------|------------|-----------|-----------|
| a.                                                                                     | [op]<br>r e k i n i                            |           | *!         |           |           |
| b.                                                                                     | [OP]<br>op<br>op op<br>r e k e n i             |           | *!         | *         | *         |
| c.  | [OP]<br>op<br>op<br>op<br>op op<br>r e k i n e |           |            | *         | *         |
| d.                                                                                     | [OP]<br>op OP<br>op op op<br>r e k e n e       |           |            | **!       | **        |
| e.                                                                                     | [op]<br>op<br>op<br>op<br>op<br>r e k i n i    |           | *!         |           | *         |
| f.                                                                                     | r i k i n i                                    | *!        |            |           |           |

We have now seen c’Lela lowering harmony, which applies from a root vowel to the last suffix vowel, skipping any intermediate vowels. This seems contrary to the current approach, which prefers spreading to the closest target, provided that all other things are equal. However, all other things are *not* equal. A high ranked

constraint may prefer spreading to the rightmost vowel. The true power of the current approach is in that it allows for transparency of intermediate targets. In c'Lela the faithfulness constraint *DEPLINK*[open] prefers transparency of intermediate vowels, just as we have seen in other cases of transparency analyzed in section 3.2. In contrast, the constraints on heads prefer local spreading, but are ranked below *DEPLINK*[open].

C'Lela is not unique in its spreading properties. Meadow Mari—also known as Eastern Cheremis (Sebeok & Ingemann 1961; Odden 1977, 1980, 1991; Padgett 2002a)—presents another example of spreading of rounding to the rightmost vowel. This suggests that alignment constraints parallel to *FINALOPENV* in (164) need to be extended to other features. However, the Meadow Mari pattern is considerably more complex because of various blocking phenomena and because both rounding and fronting/backness harmony are involved. Rounding harmony has two additional caveats. First, only the vowels that are absolutely word-final are targeted, whereas the ones followed by an obstruent are not. Second, any vowel but schwa blocks spreading. Both facts can be captured by the current approach. In the analysis of the Mari pattern, the alignment constraint targets the final root node rather than the final vowel, as we have seen in c'Lela. Blocking by vowels is due to other constraints, which will be introduced in chapter 6.

In the greater scheme of things, Icelandic and c'Lela are closely related. They both exhibit a pattern that involves a single target out of many possible targets. In Icelandic, the closest open vowel is targeted. This is the default position which follows directly from the current representations of transparency. In particular, transparency comes at a price in the form of violations of constraints on heads. This suggests that transparent segments will never surface, unless they are between a trigger and a target, and as such required by the Strict Locality Condition. The analyses of Icelandic and c'Lela make this point particularly explicit.

In c'Lela on the other hand, the target that is further from the trigger is preferred. The data seem to directly contradict the proposed representational solution. Upon closer examination, however, it turns out that the data actually offer further support. Spreading to the final vowel is attributed to a different alignment constraint. This is markedly different from Icelandic in two respects. First, the alignment constraint in Icelandic is distance sensitive, while the one in c'Lela is not. Second, Icelandic has a high ranked constraint on feature heads that inhibits spreading, which is not active in c'Lela. What the current approach predicts, is that intermediate targets may be skipped rather than becoming targets themselves. Thus, we can conclude that c'Lela does not constitute a counterexample. Instead, it provides further arguments for why transparency is tied to a particular feature spreading pattern rather than an individual segment. That is to say, transparent

segments are marked compared to targets, and such markedness is determined by the targeted structure of the alignment constraint.

## 5.5 Finnish

In the previous sections, I have so far examined two languages that show a particular relationship between transparent segments and targets. The Icelandic data show that closer targets are generally preferred to distant targets. C’Lela, on the other hand, shows that a distant target may be selected under certain conditions. What unifies both patterns are markedness constraints. In Icelandic, alignment prefers spreading to all available targeted structures. However, the constraint on heads limits spreading to the closest target. In contrast, the alignment constraint in c’Lela overrides any effects of other constraints and enforces spreading to the target closest to the right edge. A faithfulness constraint ranked above constraints on heads prefers the fewest targets. Put differently, in both languages the ranking of alignment constraints over faithfulness restricts spreading to a class of targets. In c’Lela the class consists of only one segment, which is the one closest to the word edge. In Icelandic, on the other hand, constraints on heads spread to the closest target.

As discussed at length in part I, a high ranked alignment constraint solely determines what the targets of assimilation are. More specifically, the targets are specified by the targeted structure of an alignment constraint. All segments fully associated with the targeted structure potentially incur a violation mark of the relevant alignment constraint, which means that spreading to those segments is preferred. For example, the constraint  $*\omega([\text{rtr}], \text{open})$  (184) is active in Wolof and favors spreading to the root nodes associated with [open]. However, a low ranked faithfulness constraint effectively prohibits full association to other segments. More specifically, the ranking  $*\omega([\text{rtr}], \text{open}) \gg \text{DEPLINK}[\text{rtr}]$  enforces outputs in which [rtr] is associated only with [open] segments, but not with all segments. The joint effect of the two constraints is that it is more important to target some segments (determined by a high ranked alignment constraint), but not other segments (determined by a faithfulness constraint which outranks other alignment constraints). This latter group of segments surface as transparent rather than blockers, because neither alignment nor faithfulness constraints can cause blocking by a segment.

In this section, I further look into the relationship between alignment and faithfulness constraints. Although this has been done to some degree in part I, a closer examination is needed in the light of the revised representations. I will look at a pattern which differs considerably from the previously reported cases. In Finnish front/back harmony, targets do not form a closed natural class. No single feature is common to targets to the exclusion of all other segments. This

means that no single alignment constraint can be used in an analysis of Finnish data. I instead propose that such patterns are attributed to the effect of multiple alignment constraints. These constraints have the same spreading feature, but differ in targeted structures. This suggests that there are two natural classes of targets rather than a single one.

### 5.5.1 Data

Finnish is among the most well-studied cases of vowel harmony. The front/back harmony pattern has two transparent vowels, which form a natural class. However, the targets do not form a natural class, since both low unrounded and non-low round vowels are targeted. This immediately presents a challenge to the current approach based on alignment constraints. As we have seen in part I, each alignment constraint contains a single targeted structure. The Finnish data instead require two alignment constraints, one that targets low vowels and the other that targets round vowels. I show that the current approach can adequately account for the data. Furthermore, it reveals an interesting connection between transparent segments and targets.

As we have seen in section 2.2.2, Finnish has backness harmony. This pattern is one of the best understood and most widely studied cases of vowel harmony (including Kiparsky 1973, 1981; Skousen 1972; Anderson 1975, 1980a,b; Campbell 1980, 1981; Halle & Vergnaud 1981; Goldsmith 1985; Välimaa-Blum 1987, 1999; Vago 1988; Ringen 1975/1988; Ringen & Heinämäki 1999; Baković 2000; Krämer 2002). In this section, I give a more detailed analysis, focusing on the relationship between transparent segments and targets.

The Finnish vowel inventory contains eight vowels (166). This inventory is doubly asymmetrical. First, there are three front unrounded vowels, but only one back unrounded vowel. Second, the low vowels are all unrounded, while the non-low vowels are of two types—round and unrounded. The vowel inventory in (166) is complemented by the relevant features, which will be used in the analysis. All other features are left out. Note that the features used are fairly standard, with the exception of [closed]. Here, this feature is the privative equivalent of [–low]. Other works use similarly named features (Clements 1985b; Sagey 1990; Odden 1991; Clements & Hume 1995; Morén 2003, 2006b). The feature [close] is also directly parallel to the feature [open], which is the privative equivalent of [–high] and has been used extensively throughout this thesis.

(166) Finnish vowel inventory

|       |      |          |            |
|-------|------|----------|------------|
|       | [rd] | [rd]     |            |
|       | i    | y        | u [closed] |
|       | e    | ø        | o          |
| [low] | æ    | ɑ        |            |
|       |      | [ back ] |            |

Remember that Finnish—(7), repeated with more examples in (167) below—exhibits front/back vowel harmony. Front root vowels come with front suffix vowels, while back root vowels come with back suffix vowels; consonants are unaffected.<sup>6</sup>

(167) Alternating vowels (Ringen 1975/1988:77; Ringen & Heinämäki 1999:305, 306; Krämer 2003:159, Ryan Johnson, p.c.)

|          |                  |          |                       |
|----------|------------------|----------|-----------------------|
| pøytæ-næ | ‘table-ESSIVE’   | poutɑ-nɑ | ‘fine weather-ESSIVE’ |
| pyøræ-næ | ‘wheel-ESSIVE’   | kuoro-nɑ | ‘choir-ESSIVE’        |
| næh-kø:n | ‘see-DIRECT.SG’  | tul-kø:n | ‘come-DIRECT.SG’      |
| tyø-kø:n | ‘work-DIRECT.SG’ | tuo-kø:n | ‘bring-DIRECT.SG’     |
| næk-ø    | ‘sight’          | tul-ø    | ‘coming’              |
| kæ:nt-ø  | ‘turn’           | ka:t-ø   | ‘fall’                |

Not discussed so far is the fact that the front non-low vowels {i, e} do not alternate. They always surface as front and do not interfere with spreading, as in (168). That is, non-low front vowels are transparent to vowel harmony.

<sup>6</sup>Baković (2000) notes that Finnish also has prefixes, which alternate depending on the quality of the root vowel. I now provide two arguments to the contrary. First, as Ryan Johnson points out to me, all Baković’s examples (p. 7) are cases of reduplication, in which vowel harmony can be attributed to other mechanisms. In Finnish reduplication, the first foot is copied and added to the left of the base. The second consonant is replaced by [p] and is normally followed by a round vowel that agrees in backness with the following root: [tæpø-tæysi] ‘very full’, [upo-usi] ‘very new’, [typø-tyhjæ] ‘very empty’. However, some examples have [i] in the second position, even though this vowel is not in the second syllable of the base: [supi-suomalainen] ‘very Finnish’, [hipi-hilja:] ‘very quiet’. Furthermore, the example [tipo-ties:æ] ‘disappeared, lost completely’ shows that the second vowel may be back even though the base does not contain any back vowels. This strongly suggests that the reduplication pattern is markedly different from vowel harmony. Second, the one clear prefix, /epæ-/ ‘non-, un-’, does not harmonize: [epæ-reilu] ‘unfair’, [epæ-varma] ‘unsure’. Both pieces of evidence are consistent with a generalization that prefixes are outside of the domain of assimilation and that the pattern is progressive.

(168) Transparent vowels (Ringen 1975/1988:77; Ringen & Heinämäki 1999:305; Krämer 2003:159)

|                   |                  |                    |                  |
|-------------------|------------------|--------------------|------------------|
| kæ <u>d</u> e-l:æ | ‘hand-ADESSIVE’  | tuol <u>i</u> -l:a | ‘chair-ADESSIVE’ |
| næ <u>k</u> e-væt | ‘see-3PL’        | tunte <u>v</u> at  | ‘feel-3PL’       |
| kæt <u>e</u> -næ  | ‘hand-ESSIVE’    | kot <u>i</u> -na   | ‘home-ESSIVE’    |
| hyv- <u>i</u> -næ | ‘good-PL-ESSIVE’ | tsa: <u>r</u> i-na | ‘czar-ESSIVE’    |

The same is true for a string of several front non-low unrounded vowels {i, e}. In (169) we see three roots followed by a string of suffixes, of which only the final alternates. The intermediate suffixes containing {i, e} are not affected. In these examples, the final suffix always agrees in backness with the root vowel other than {i, e}.<sup>7</sup>

(169) Multiple transparent vowels (Krämer 2003:166)

|        |           |                                    |                       |
|--------|-----------|------------------------------------|-----------------------|
| ui-da  | ‘to swim’ | ui-ske-nt-ele-mi-se-ni-k <u>o</u>  | ‘my swimming around?’ |
| syø-dæ | ‘to eat’  | syø-ske-nt-ele-mi-se-ni-k <u>ø</u> | ‘my constant eating?’ |
| teh-dæ | ‘to do’   | te:-ske-nt-ele-mi-se-ni-k <u>ø</u> | ‘my pretending?’      |

The final set of data in (170) concerns roots containing only front vowels. These take front suffixes.

(170) Front vowels take front suffixes

|                   |                     |                   |                    |
|-------------------|---------------------|-------------------|--------------------|
| tie-l: <u>æ</u>   | ‘road-ADESSIVE’     | velje-l: <u>æ</u> | ‘brother-ADESSIVE’ |
| kiele-l: <u>æ</u> | ‘language-ADESSIVE’ | kiire-l: <u>æ</u> | ‘rush-ADESSIVE’    |
| tie-n <u>æ</u>    | ‘road-ESSIVE’       | velje-n <u>æ</u>  | ‘brother-ESSIVE’   |
| kiele-n <u>æ</u>  | ‘language-ESSIVE’   | kiire-n <u>æ</u>  | ‘rush-ESSIVE’      |

To summarize, Finnish vowel harmony can be characterized as follows. First, front vowels alternate with back vowels. Second, front non-low unrounded vowels {i, e} never alternate and do not interfere with spreading, which suggests they are transparent.

At first, it seems that the pattern could be analyzed as both spreading of the feature [front] or [back]. In an analysis of Finnish as fronting harmony, the suffixes are back by default and become front when preceded by a front vowel. The problem with this solution is that high unrounded front vowels {i, e} are also [front]. The data in (170) suggest that these two vowels trigger spreading, since roots containing only them are followed by front rather than back suffixes. However, the data in (169) show spreading from {i, e} to the suffix in some cases, but not in others.

---

<sup>7</sup>A noted exception to this generalization are the patterns found in some loanwords ending on two or more {i, e}. These roots tend to take front suffixes, even when back ones are expected (see Välimaa-Blum 1999; Ringen & Heinämäki 1999 for details). I will not attempt to analyze these exceptional patterns.

This does not seem to be a viable analysis. Another option is to say that {i, e} are not [front]. While this is possible in some frameworks, it is not possible in the current approach, which assumes a rather simple correspondence between phonetic content (i.e., front position of the tongue and high F2) and phonological features (such as [front] in this case). Hence, I will take the alternative approach, which regards Finnish as backness harmony. We have seen in (167) that back root vowels are followed by back suffixes. Conversely, front root vowels are followed by front suffixes. Finally, the non-low unrounded vowels {i, e} are transparent. This means that back root vowels are followed by back suffixes even if there are intermediate suffixes containing {i, e}, as in (169). The final piece of the data are roots containing only transparent vowels {i, e}. In these, suffix vowels surface as front, since there is no trigger containing the feature [back]. In short, Finnish shows spreading of [back] that targets vowels and applies rightwards from roots to suffixes. The vowels {i, e} are transparent to the process.

### 5.5.2 Analysis

I now turn to an analysis based on the interaction of alignment and faithfulness. The faithfulness constraint against spreading the feature [back] is DEPLINK[back]. This constraint is outranked by the alignment constraint. Recall tableau (33) in which I analyzed the pattern using the constraint \* $\omega$ ([round],vowel). However, given the fact that {i, e} are transparent to vowel harmony, a revision is required. This is because transparency cannot be attributed to any other constraint. No constraint enforces transparency. This is because transparent segments also violate constraints on heads. Consider for example, the constraint \*[BACK closed]. This constraint is violated equally by a transparent segment just as it is by a target (as long as another target follows). In other words, \*[BACK closed] prefers that {i, e} become icy targets, and not transparent.

As we have seen in section 3.2, transparency informs the analysis in terms of the targeted structure of the alignment constraint, which should be the complement of the set of all transparent segments. In Finnish, all consonants and the two vowels {i, e} are transparent. Under no universal feature theory can these segments be grouped into a natural class to the exclusion of all other segments.<sup>8</sup> Instead what I propose is that the pattern in Finnish is attributed to two alignment constraints. Both have the spreading feature [back], the domain (PWd) and the f-precedence relations in common (the spreading feature f-precedes the targeted structure). They differ in the targeted structure. One targets [low] vowels, while the other

---

<sup>8</sup>Substance-free phonology can capture these patterns, since there is no a priori restriction on feature combinations (Morén 2003, 2006b; Youssef 2010, to appear; Blaho 2008; Samuels 2009). This approach has no cross-linguistically valid strategy to exclude a feature that would be common to all consonants and {i, e}, but not to other vowels.



targets [round] vowels. If we look at the Finnish vowel inventory in (166) that the sets of low vowels {æ, a} and round vowels {y, ø, u, o} are disjunctive. Hence the two alignment constraints that refer to these two classes will not interact, which means that we do not know which outranks the other.

The relevant alignment constraints are \* $\omega$ ([back],round) and \* $\omega$ ([back],low). The two constraints are phonetically and typologically grounded. First, there is a phonetic connection between backness and rounding on the one hand and backness and lowering on the other. The feature [round] has an articulatory correlate in lip rounding, which lowers F2. Back vowels also have a lower F2 compared to front vowels. The feature [low], on the other hand, correlates with tongue height. Lowering the tongue body increases F1. By definition, F1 is lower than F2. A high F1 restricts the possible value of F2. Hence, a higher F1 may lead to a higher F2. Second, there is also a typological connection between the two pairs of features. As regards rounding and backness, there are many languages with only front unrounded and back rounded vowels, whereas there is no language with only front rounded and back unrounded vowels. Rounding and backness spread together much more commonly than rounding and fronting (Odden 1991; Kaun 1995). Furthermore, backness harmony that affects unrounded vowels also affects rounded vowels, but not necessarily vice versa. There is no Anti-Finnish with two sets of front vowels, of which only unrounded are subject to backness harmony (triggered by any back vowel). As regards backness and lowering, the story is similar. The opposite features, [front] and [high] are related to one another. That is, if a language has a front vowel, it will likely be a high front vowel (Archangeli & Pulleyblank 1994). Second, as we will see high vowels can be transparent to many types of vowel harmony (rounding, backness, RTR), whereas low vowels are typically not transparent. This suggests that there is both independent phonetic and typological support for the two constraints \* $\omega$ ([back],round) and \* $\omega$ ([back],low).

The effect of the ranking is shown in (171). A single word that includes transparent vowels, a round and a low vowel is evaluated. Candidate (a) has no spreading and fatally violates the alignment constraints. Candidates (b) and (c) have full association of [back] only with the low or round vowel, respectively. Each fatally violates one of the alignment constraints. Candidate (d) wins because it satisfies both alignment constraints, while it also incurs the fewest violations of DEPLINK[back], as opposed to candidate (e). The last candidate violates DEPLINK[back] too many times to win, since all vowels—including the vowels that should be transparent—are fully associated with the feature [back]. Keep in mind that Finnish has no icy targets and the relevant constraints on feature heads are ranked below DEPLINK[back], just as we have seen in c'Lela.

(171) pari-na-si-ko ‘as your partner?’ (Kiparsky 1981:10)

| <p>[b]<br/>/ p ɔ r i - n æ - s i - k ø /<br/>[l] [l] [r]</p>                                          | <p>*ω([bk],rd)</p> | <p>*ω([bk],lo)</p> | <p>DEPLK[bk]</p> |
|-------------------------------------------------------------------------------------------------------|--------------------|--------------------|------------------|
| <p>a. [b]<br/>p ɔ r i n æ s i k ø<br/>[l] [l] [r]</p>                                                 | <p>*(!)</p>        | <p>*(!)</p>        |                  |
| <p>b. [B]<br/>b<br/>b<br/>b<br/>b<br/>p ɔ r i n æ s i k ø<br/>[l] [l] [r]</p>                         | <p>*!</p>          |                    | <p>*</p>         |
| <p>c. [B]<br/>b<br/>b<br/>b<br/>b<br/>b<br/>b<br/>b<br/>b<br/>p ɔ r i n æ s i k ø<br/>[l] [l] [r]</p> |                    | <p>*!</p>          | <p>*</p>         |
| <p>d. [B]<br/>b<br/>b<br/>b<br/>b<br/>p ɔ r i n æ s i k ø<br/>[l] [l] [r]</p>                         |                    |                    | <p>**</p>        |
| <p>e. [B]<br/>b<br/>b<br/>b<br/>b<br/>p ɔ r u n æ s u k ø<br/>[l] [l] [r]</p>                         |                    |                    | <p>***!*</p>     |

To conclude, Finnish vowel harmony is slightly more complex than the previously discussed cases, because the pattern involves two alignment constraints that differ only in their targeted structures. The two alignment constraints outrank the faithfulness constraint `DEPLINK[back]`. The targeted structures of these alignment constraints are inherently connected to transparent segments. Consider the alignment constraints that outrank the relevant `DEPLINK[f]` constraint, and the sets of segments containing the targeted structures of these constraints. Formally speaking, transparent segments are defined as the intersection of complements of these sets. This is stated in (172). Note that if any constraint has a root node as the targeted structure, all segments will be in the set of segments containing that structure. The complement of such a set is an empty set. An intersection of an empty set with any other set is also an empty set. Hence, no segments will be transparent.

- (172) The connection between transparency, alignment and `DEPLINK[f]`  
 Let  $C_a, C_b \dots C_n$  be alignment constraints of the type  $*Domain([f],x)$ .  
 Let  $A$  be the set of segments containing the targeted structure of  $C_a$ .  
 Let  $B$  be the set of segments containing the targeted structure of  $C_b$ .  
 ...  
 Iff  $\{C_a, C_b \dots C_n\} \gg DEPLINK[f]$ , then the set of transparent segments  
 $T = \neg A \cap \neg B \cap \dots \cap \neg N$

In most languages seen so far, there was only one alignment constraint and the set of transparent segments was easily determined as the complement of (segments containing) a single targeted structure. Finnish presents a more complex case in which two alignment constraints are required. The targeted structures of the two alignment constraints are [low] and [round], which means that their intersection of complements are all non-low and non-round segments, which includes all consonants and front unrounded non-low vowels {i, e}. This is what is found in Finnish. I will further discuss transparency and contrast it with blocking in chapter 6.

## 5.6 Summary

The previous chapter provided evidence for two different levels of prominence in feature spreading. Regular targets are more prominent than icy targets. This chapter extends this idea to transparent segments. Feature spreading thus involves multiple levels of prominence: propagators display a more prominent realization of the feature compared to non-propagators (non-triggers and final targets). Transparent segments, on the other hand, represent an even lower level of prominence with respect to the spreading feature.

The three different levels of prominence are captured by different representations. Non-final targets are heads of the spreading feature, while final targets are not headed. The distinction between transparent segments is in whether a particular root node is linked to a non-branching node of the spreading feature: targets are linked to a non-branching node, while transparent segments are linked to the feature via a branching node headed by a target.

The extension of hierarchical and binary organization of feature spreading to transparent segments has one important consequence: spreading is always strictly local. Apparent non-locality (of targets) is captured by a representational difference and governed by the interaction of constraints. Alignment, faithfulness constraints and constraints on heads were introduced in the previous chapters. This chapter makes them specific to the modified representations.

On the one hand, constraints on heads play a crucial role in restricting transparent segments. When other constraints cannot distinguish between multiple identical targets, a constraint on heads prefers the target that would require the fewest transparent segments. Such a target is the one closest to the trigger. On the other hand, alignment and faithfulness constraints refer only to triggers and targets, but remain agnostic about transparent segments.

In the current framework, transparency is dealt with in a very different way than any of the previous approaches. The first difference is representational. Transparent segments are similar to targets in that they are associated with a feature. At the same time, the association lines come in several different flavors, which allows for a distinction between transparent segments and targets. The second difference is in terms of constraints. Alignment constraints distinguish targets from transparent segments. More specifically, alignment constraints prefer some targets to others. Consequently, a transparent segment incurs a violation of some alignment constraint, whereas a target does not. The crucial point here is that not all transparent segments are equally penalized: some violate more constraints than others. This prediction is further examined in the following chapter.

# Chapter 6

## Blockers

So far I have looked at two types of segments: targets and transparent segments. I distinguish the two types both in terms of representations and constraints that refer to them. On the one hand, targets are associated with a non-branching node of a feature, while transparent segments are directly associated with a binary branching feature node headed by a trigger or a target. Put differently, association lines of the two types of segments differ: targets are fully associated with a feature, whereas transparent segments are only d-associated. On the other hand, targets are referred to by some constraints. In particular, alignment and faithfulness constraints are affected only by full association to targets. Concurrently, the same constraints fail to see d-association to transparent segments. Hence, the targeted structure of an alignment constraint determines possible targets, while faithfulness constraints prefer transparency on all other segments. This situation differs from constraints on heads, which are equally violated by any type of association. A non-final target violates a constraint on heads just as a transparent segment does. Thus, constraints on heads stop propagation of a feature on a particular segment, regardless of whether it is a target or a transparent segment. If such a segment is a target, it surfaces as icy; if such a segment is transparent, it stops spreading on a preceding target. The latter effect can be seen in cases where multiple identical targets are available, in which case constraints on heads prefer the target closest to the trigger (section 5.3).

In this chapter, I focus on segments that are not associated with the spreading feature. The most prominent example of such segments are blockers. These segments block spreading of a feature. Blocking segments thus complement the two previously analyzed environments in which assimilation is inhibited (domain edges, icy targets).

I first show that blockers cannot be explained by any of the previously proposed constraints. For example, alignment constraints prefer transparency over blocking (within a domain). In response to this challenge, I propose another class of con-

straints: feature co-occurrence constraints. The effect of these constraints in most previous approaches differs from their effect in BDT. The difference stems from the fact that transparent segments are also associated with a feature in BDT. Thus, feature co-occurrence constraints are violated by targets and transparent segments, just as constraints on heads are. In contrast, segments that are not associated with a feature—including blockers—do not violate feature co-occurrence constraints. Hence, a high ranked feature co-occurrence constraint effectively prefers complete termination of spreading, i.e. blocking rather than transparency.

This chapter is organized as follows. Section 6.1 presents a case of blocking and shows that the constraints proposed so far cannot capture them. Section 6.2 introduces feature co-occurrence constraints. Section 6.3 offers an analysis of blocking in Southern Palestinian Arabic based on feature co-occurrence constraints. Section 6.4 compares blocking and transparency. The patterns surface depending on the ranking of feature co-occurrence constraints and alignment constraints. Section 6.5 provides two other cases of blocking. Section 6.6 presents a cross-linguistic study of nasal harmony focusing on blocking and transparency. Section 6.7 concludes.

## 6.1 Introduction

Blocking is a well-known phenomenon in assimilation. Blocking segments cannot be associated with a feature; they terminate any further spreading. This way blockers can be contrasted with transparent segments. At the same time, blockers are similar to transparent segments in that they are not fully associated with a particular feature. A transparent consonant in vowel harmony, for example, is not fully pronounced with the relevant vocalic feature. A blocker, however, represents a further step away from the spreading feature. A blocker is not pronounced with a feature at all. In the current approach, this can be translated into a representational difference between the two types of non-targets. Transparent segments are d-associated with a feature, while blockers are not associated with a feature.

Recall the Strict Locality Condition (142), which states that spreading of a feature is not possible across a non-associated root node. Blockers are not associated with the relevant feature, which effectively terminates spreading. Blocking segments thus complement the two previously analyzed environments in which assimilation is inhibited. Some assimilation processes are terminated once they reach a domain edge. For example, SPalestinian emphasis spread is limited to a prosodic word and does not extend beyond its edge (section 3.2.1). Other assimilation processes are terminated by icy targets. For example, Icelandic u-umlaut cannot spread beyond a targeted open vowel (sections 4.3 and 5.3). Blockers are the third and final structure that terminates assimilation.

Unlike icy targets, blockers never alternate. This suggests that they are not associated with a feature, and hence violate fewer constraints on heads than transparent segments and targets. They also satisfy DEPLINK[f] constraints, since a feature does not spread to a blocker. Furthermore, alignment constraints never enforce blocking by a segment, but limit blocking to a set of segments within a domain. Hence, we can conclude that no previously proposed constraints are suited to capture blocking. In the remainder of this section, I demonstrate this point with an example.

Recall SPalestinian emphasis spread analyzed in section 3.2.1. We have seen in (39) that emphasis spread affects all segments preceding a trigger within a prosodic word. However, this characterization is incomplete. SPalestinian also exhibits rightward spreading, which applies within a prosodic word. The data in (173) show that rightward spreading is not unbounded, but instead blocked by {i, y, j, ʃ}. I follow the standard notation in which emphatic segments are capitalized.

- (173) Rightward emphasis spread in Southern Palestinian Arabic (Davis 1995: 473–474)
- |         |                    |
|---------|--------------------|
| ṬUUB-AK | ‘your blocks’      |
| ṬWAAL   | ‘long.PL.’         |
| Ṭiin-ak | ‘your mind’        |
| ʃATʃaan | ‘thirsty’          |
| ʃAyyaad | ‘hunter’           |
| DAjjat  | ‘type of noise.PL’ |

Emphasis spread can be analyzed as spreading of the feature [rtr] (Davis 1995; McCarthy 1997). This feature spreads from a trigger to all preceding segments, as seen in section 3.2.1. The focus of the discussion in this section is rightward spreading. While leftward spreading is unbounded within a prosodic word, rightward spreading is blocked by {i, y, j, ʃ}. One way to look at these blockers is to say that they form a natural class. Davis (1995) proposes that these segments have a [+front] feature in common (see also Hall 1997 for a similar proposal). If so, then the blocking effect could be simply attributed to some constraint that penalizes the combination of [rtr] and [front].

In this thesis, I have so far proposed three classes of constraints: (i) alignment constraints, (ii) faithfulness constraints, and (iii) constraints on heads. The potentially relevant constraints in SPalestinian are in (174). First, in SPalestinian [rtr] spreads rightwards to root nodes, within a Prosodic Word. The first possible alignment constraint is  $*\omega$ ([rtr], ×), while the other constraints target a subset of segments:  $*\omega$ ([rtr], vowel),  $*\omega$ ([rtr], open). Second, spreading involves linking of [rtr], which violates DEPLINK[rtr]. Third, the potentially active constraint on

heads may effectively stop spreading, which is what happens in SPalestinian. The relevant constraint is \*[RTR front].

- (174) Potentially relevant constraints in SPalestinian
- a. Alignment constraints (sections 2.2.2, 5.2.2)
    - \* $\omega$ ([rtr],  $\times$ )
    - \* $\omega$ ([rtr], vowel)
    - \* $\omega$ ([rtr], open)
  - b. Faithfulness constraints (sections 2.2.2, 5.2.2)
    - DEPLINK[rtr]
  - c. Constraints on heads (sections 4.2.4, 5.2.2)
    - \*[RTR front]

In (175) I give the ranking for an input with an initial trigger followed by a blocker. Recall chapter 5 and the fact that constraints on heads can terminate spreading on a particular segment. The constraint \*[RTR front] blocks spreading from front segments, including [Y]. This constraint outranks all other constraints. Two of the alignment constraints, \* $\omega$ ([rtr], vowel) and \* $\omega$ ([rtr], open), are ranked next. These constraints outrank DEPLINK[rtr]. In contrast, \* $\omega$ ([rtr],  $\times$ ) is ranked the lowest, because not all segments in rightward spreading are targets.

Tableau (175) shows eight candidates. Candidate (a) has no spreading and fatally violates one of the high ranked alignment constraints. Candidates (b–e) have full spreading to the first target, but some of them show d-association to the following segments. All these candidates fare equally on most constraints. They violate each of the two high ranked alignment constraints once; they violate DEPLINK[rtr] once; they violate the low ranked alignment constraint three times. However, only candidates (d) and (e) violate the high ranked constraint on heads. This is because [yy] is associated with both [front] and is a head of the feature [rtr]. More specifically, these two candidates have transparent segments that require their own domains. These domains create heads on the preceding target *and* all preceding transparent segments. The intended blocker, [yy] is the leftmost transparent segment and is a head of [rtr] if any transparent segments follow. The remaining candidates (f–h) have full association between the feature [rtr] and the segment [yy]. Candidate (f) fatally violates DEPLINK[rtr]. Candidates (g–h) have targets beyond [YY]/[yy] and fatally violate \*[RTR front].



## (175) ŞAyyad ‘hunter’

|       | *[RTR fr] | *ω([rtr],op) | *ω([rtr],vow) | DEPLINK[rtr] | *ω([rtr],×) |
|----------------------------------------------------------------------------------------|-----------|--------------|---------------|--------------|-------------|
| a.    |           | **(!)        | **(!)         |              | ****        |
| b.    |           | *            | *             | *            | ***         |
| c.    |           | *            | *             | *            | ***         |
| d.    | *!        | *            | *             | *            | ***         |
| e.   | *!        | *            | *             | *            | ***         |
| f.  |           | *            | *             | **!          | **          |
| g.  | *!        |              |               | ***          | *           |
| h.  | *!        |              |               | ****         |             |

Tableau (175) shows that these constraints cannot distinguish between candidate (b) with a non-associated blocker and candidate (c) with a d-associated blocker. While most other candidates can also win given a different ranking of the constraints, no ranking can distinguish candidate (b) from (c). We have so far assumed that (b) is the intended winner in SPalestinian. However, most languages do not seem to exhibit a distinction between outputs parallel to candidates (b) and (c). So, is the failure to distinguish between the two candidates a real theoretical and empirical problem? The answer to this question becomes clear when we look at constraints on heads and their effects on blockers.

First, consider an input that contains a string of two consecutive blockers. D-associating both blockers would create a head on one of them, violating the relevant constraint on heads. This suggests that blockers come in two varieties: the blocker immediately adjacent to the final target is different from other blockers. The support for such a claim is that there could be some phonetic overlap between the last target and the following blocker. The challenge, on the other hand, is that such an approach contradicts the idea that blockers surface because they are inconsistent with the spreading feature. The representations like (175-c) suggest that blockers can be associated with a feature. Thus, allowing such candidates would require a very different idea of what blocking is.

Second, given Richness of the Base we need to consider inputs in which blockers are underlyingly associated with a feature. As we have seen in section 4.3.2, constraints on heads prefer no spreading from such inputs, but allow them to surface faithfully. That is, an input /Y/ in SPalestinian would map to a faithful output [Y], but would not trigger spreading. This is not the case in SPalestinian. Instead, what most analyses assume is that /Y/ maps to [y]. In the current model, no constraint can achieve that effect. In what follows, I make use of a well-known constraint family to achieve this mapping. In addition, the same constraints will also prefer candidates with an unassociated blocker (175-b) to a d-associated blocker (175-c), regardless of where they are ranked.

We have now seen that constraints on heads cannot distinguish non-associated blockers from d-associated blockers. In response to this challenge, I introduce a constraint that prefers blocking by segments that are not associated with the spreading feature.

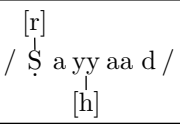
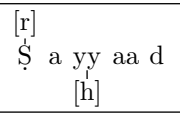
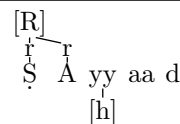
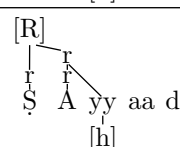
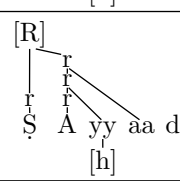
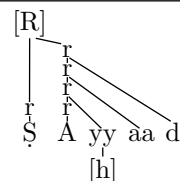
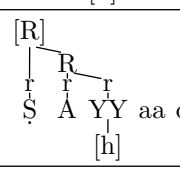
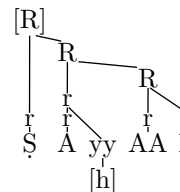
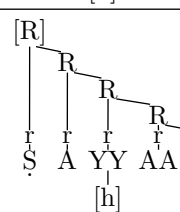
## 6.2 Blocking in Binary Domains Theory

In this section, I propose a constraint family that enforces blocking. I follow the standard assumption that blockers are not associated with a feature. One way of capturing this is by saying that blockers *cannot* be associated with a feature. Feature co-occurrence constraints are well-established constraints that can have

precisely such an effect. Furthermore, BDT predicts that feature co-occurrence constraints cannot be satisfied by skipping. This is because skipped configurations are ruled out by the Strict Locality Condition (142). Hence, feature co-occurrence constraints are sufficient to enforce blocking.

Below, I first introduce the feature co-occurrence constraints (section 6.2.1). Then I revisit the representations of blockers and contrast them with transparent segments (section 6.2.2). This sets the stage for the analyses of blocking in the subsequent sections.

### 6.2.1 Feature co-occurrence constraints

In section 6.1 we have seen that no previously proposed constraint prefers blocking by segments that are not associated with the spreading feature. In response to this challenge, I propose that blocking is enforced by feature co-occurrence constraints.

Feature co-occurrence constraints are well established in the literature (Stanley 43; Archangeli & Pulleyblank 1994; Walker 1998/2000). They penalize a combination of two (or more) features. These constraints are phonetically grounded. A feature co-occurrence constraint refers to features that are incompatible in terms of articulation, acoustics, or perception.

Recall section 5.2.2 and the fact that constraints may be sensitive to different types of association. Alignment and faithfulness constraints, for example, see only full association. Constraints on heads (157), on the other hand, are violated by any type of association. Feature co-occurrence constraints exhibit the same property: they are equally violated by full or dependent association.

Recall the feature co-occurrence constraints template in (88)—repeated in (176). Notice that feature co-occurrence constraints penalize any root node associated with two features; they are violated by targets and transparent segments. This will play a crucial role in what follows.

- (176)   \*[f g]  
           Assign a violation for every root node  $\times$ , iff  $\times$  is associated with features [f] and [g].

When a feature co-occurrence constraint is ranked above the relevant alignment constraint it will act as a definite blocker of spreading. When the ranking is the opposite, the feature co-occurrence constraint will only inhibit spreading beyond the final target. In other words, under no ranking of constraints on heads, faithfulness constraints and feature co-occurrence constraints can transparent segments surface beyond the final target.

Tableau (177) demonstrates the full effect of \*[f g]. The input contains four segments, of which only the third is associated with [g]. One can think of the

candidates in terms of spreading of [f], which targets only segments associated with [h]. Candidate (a) is faithful and does not violate \*[f g]. Candidate (b) has spreading to one root node, which still does not violate \*[f g]. Candidate (c) has a transparent third root node. Feature co-occurrence constraints do not distinguish between the two types of association. Hence, the third segment violates \*[f g]. Notice that candidates (b) and (c) fare differently in terms of \*[f g]. These two candidates could not be distinguished using any other constraints, including constraints on heads. Candidate (d) has spreading to all segments associated with [h]. However, because of the Strict Locality Condition (142), no root node can be skipped. Hence, the third root node is d-associated with a feature, and transparent. D-association violates feature co-occurrence constraints. Finally, candidate (e) has full spreading to all segments. If we compare (d) and (e), we can see that both full and dependent association violate \*[f g].

(177) \*[f g] evaluations

|                                                                                                                                                                                                                                               |        |
|-----------------------------------------------------------------------------------------------------------------------------------------------------------------------------------------------------------------------------------------------|--------|
| $\begin{array}{c} [f] \\   \\ / \times \times \times \times / \\   \quad   \quad   \quad   \\ [h] [h] [g] [h] \end{array}$                                                                                                                    | *[f g] |
| $\begin{array}{c} [f] \\   \\ \times \times \times \times \\ \text{a. }   \quad   \quad   \quad   \\ [h] [h] [g] [h] \end{array}$                                                                                                             |        |
| $\begin{array}{c} [F] \\   \quad \diagdown \\ f \quad f \\   \quad   \\ \times \times \times \times \\ \text{b. }   \quad   \quad   \quad   \\ [h] [h] [g] [h] \end{array}$                                                                   |        |
| $\begin{array}{c} [F] \\   \quad \diagdown \\ f \quad f \\   \quad   \quad \diagdown \\ \times \times \times \times \\ \text{c. }   \quad   \quad   \quad   \\ [h] [h] [g] [h] \end{array}$                                                   | *      |
| $\begin{array}{c} [F] \\   \quad \diagdown \\ f \quad F \\   \quad   \quad \diagdown \\ f \quad f \quad f \\   \quad   \quad   \quad   \\ \times \times \times \times \\ \text{d. }   \quad   \quad   \quad   \\ [h] [h] [g] [h] \end{array}$ | *      |
| $\begin{array}{c} [F] \\   \quad \diagdown \\ f \quad F \\   \quad   \quad \diagdown \\ f \quad F \quad f \\   \quad   \quad   \quad   \\ \times \times \times \times \\ \text{e. }   \quad   \quad   \quad   \\ [h] [h] [g] [h] \end{array}$ | *      |

We have now seen that both transparent segments and targets violate a feature co-occurrence constraint. In other words, both types of segments represent a marked structure, compared to unassociated segments (non-targets, blockers). This is similar to constraints on heads which can be violated by targets or transparent segments, but contrasts with faithfulness constraints, which are only violated by targets, and not by non-targets, including transparent segments. Furthermore, alignment constraints prefer targets to transparent segments and non-targets, but only if they contain a particular targeted structure.



### 6.3 Southern Palestinian Arabic

Recall section 6.1 which discussed blocking in SPalestinian. I have shown that none of the previously proposed constraints can satisfactorily account for blocking. In particular, none of the constraints can distinguish between unassociated blockers and d-associated blockers. In section 6.2, I introduced feature co-occurrence constraints. I demonstrated that they prohibit segments to have a particular combination of features. I now demonstrate that a high ranked feature co-occurrence constraint prefers blocking.

As we have seen in sections 3.2.1 and 6.1, SPalestinian emphasis spread is bidirectional. On the one hand, emphasis spread affects all segments preceding a trigger, within a prosodic word. These data are repeated in (179-a) below, where the emphatic segments are capitalized. However, this characterization is incomplete. The data in (179-b) show that the pattern also involves rightward spreading, within a prosodic word. However, rightward spreading is not unbounded, but instead blocked by {i, y, j, ʃ}.

(179) Emphasis spread in Southern Palestinian Arabic (Davis 1995:473–474)

- |    |                                   |                          |
|----|-----------------------------------|--------------------------|
| a. | Leftward unbounded                |                          |
|    | BALLAAṢ                           | ‘thief’                  |
|    | ħAḏḏ                              | ‘luck’                   |
|    | ʔABSAṬ                           | ‘simpler’                |
|    | BAAṢ                             | ‘bus’                    |
|    | XAYYAAṬ                          | ‘tailor’                 |
|    | NAʃAAṬ                           | ‘energy’                 |
|    | TAMJIIṬA                          | ‘hair styling’           |
| b. | Rightward blocked by {i, y, j, ʃ} |                          |
|    | ṢABAĤ                             | ‘morning’                |
|    | ʕAṬFAAL                          | ‘children’               |
|    | ṬUUB-AK                           | ‘your blocks’            |
|    | ṬWAAL                             | ‘long.PL.’               |
|    | ṢOOT-AK                           | ‘your voice’             |
|    | ṬEEF-AK                           | ‘your sword’             |
|    | Ṭiin-ak                           | ‘your mind’              |
|    | ʕAṬʃaan                          | ‘thirsty’                |
|    | MAJAṢṢAṢiʃ                        | ‘it didn’t become solid’ |
|    | ṢAyyaad                           | ‘hunter’                 |
|    | ḌAjjat                            | ‘type of noise.PL’       |

Emphasis spread can be analyzed as spreading of the feature [rtr] (Davis 1995; McCarthy 1997). This feature spreads from a trigger to all preceding segments,

as seen in section 3.2.1. The focus of the discussion in this section is rightward spreading. In the previous section, I introduced feature co-occurrence constraints and suggested that they may be able to capture blocking. I now show the effect of feature co-occurrence constraints in SPalestinian, which shows blocking only in rightward spreading, but not in leftward spreading.

First, let us look at blockers {i, y, j, ʃ}. The four blocking segments seem to form a natural class. In the preliminary analysis in section 6.1, I followed Davis (1995) and Hall (1997) in that these segments have the [front] feature in common. In terms of feature co-occurrence constraints, the blocking effect can be simply attributed to the constraint \*[rtr front] (Archangeli & Pulleyblank 1994; Davis 1995; McCarthy 1997), which outranks the relevant alignment constraint. This feature co-occurrence is phonetically grounded: a retracted tongue root position correlates with the backing of the tongue body. That is to say, retracted tongue root is articulatorily compatible with back (rather than front) tongue position. The constraint is defined in (180).<sup>1</sup>

- (180)   \*[rtr front]  
           Assign a violation for every root node  $\times$ , iff  $\times$  is associated with features [rtr] and [front].

The feature co-occurrence constraint is ranked between the two alignment constraints. I now give the ranking for two inputs in SPalestinian, which differ in terms of directionality. In (181), we see an input with a final trigger. As we have seen in (42), the alignment constraint \* $\omega(\times, [rtr])$  outranks the faithfulness constraint DEPLINK[rtr]. The feature co-occurrence constraint \*[rtr front] is also outranked by \* $\omega(\times, [rtr])$ . The winning candidate (c) satisfies the alignment constraint, although it violates the other constraints. Candidate (a) with no spreading and candidate (b) with spreading to a single target, do not violate \*[rtr front], but fatally violate the alignment constraint. This ranking predicts unbounded leftward spreading.

---

<sup>1</sup>The current analysis does not depend on whether all blockers can be grouped into a single natural class. If not, multiple feature co-occurrence constraints are required.



(181) XAYYAAṬ ‘tailor’

|                                                                                      | $\omega(\times, [\text{rtr}])$ | $[\text{rtr front}]$ | DEPLINK $[\text{rtr}]$ |
|--------------------------------------------------------------------------------------|--------------------------------|----------------------|------------------------|
| a. $\text{ / x a yy aa } \overset{[\text{r}]}{\underset{\cdot}{\text{T}}} \text{ /}$ | $*!***$                        |                      |                        |
| b. $\text{ x a yy AA } \overset{[\text{R}]}{\underset{\cdot}{\text{T}}}$             | $*!***$                        |                      | *                      |
| c. $\text{ X A YY AA } \overset{[\text{R}]}{\underset{\cdot}{\text{T}}}$             |                                | *                    | ****                   |

SPalestinian has bidirectional spreading. Recall Ikwere nasal harmony from section 4.5, which shows a similar pattern, but which involves a different spreading feature. For Ikwere, bidirectionality has been attributed to two different alignment constraints: one prefers spreading to the left, while the other prefers spreading to the right. Because the two constraints can be ranked differently, they represent two different processes, which are connected solely by the fact that they involve the same spreading feature. We have seen in Ikwere that icy targets are found in leftward spreading, but not in rightward spreading. Hence the constraint preferring icy targets is ranked between the two alignment constraints, as in (118). This is directly relevant to SPalestinian, in which there are also two active alignment constraints:  $\omega(\times, [\text{rtr}])$  and  $\omega([\text{rtr}], \times)$ . The former outranks the feature co-occurrence constraint  $[\text{rtr front}]$ , as seen in (181). The latter, on the other hand, is outranked by  $[\text{rtr front}]$ . This results in a target [Y] in leftward spreading, but a blocking [y] in rightward spreading.

Tableau (182) shows rightward spreading from an initial trigger. Since rightward spreading is the focus of the current discussion, I will consider more candidates. The aim of this chapter is to come up with a solution for blocking. Feature co-occurrence constraints enforce blocking, when ranked above the relevant alignment constraint. In the present context, the constraint  $[\text{rtr front}]$  outranks the alignment constraint  $\omega([\text{rtr}], \times)$ . I add the constraint on heads  $[\text{RTR front}]$  from tableau (175) to contrast its effects with the feature co-occurrence constraint.

The winning candidate (b) spreads to all targets, but if it encounters a blocking [y], it cannot spread to or across it. Candidate (a) has no spreading and violates alignment more times. Candidates (c–e) have only one target, just as candidate

(b), but have one or more d-associated segments. In candidate (c), [yy] is d-associated with [rtr]. Given the definition of feature co-occurrence constraints (176), this d-association also satisfies the condition, and hence the constraint \*[rtr front] is violated. Candidates (d) and (e) also violate this constraint. Observe that candidates (c–e) are harmonically bounded by the winning candidate (b). This suggests that transparency will never be preferred as a result of blocking. Candidates (f–h), too, all have the supposed blocker associated with [rtr], which incurs a fatal violation of \*[rtr front].

(182) ṢAyyad ‘hunter’

| $\begin{array}{c} [r] \\   \\ \dot{\text{Ṣ}} \text{ a yy aa d} \end{array}$                                                                            | * $[rtr \text{ fr}]$ | * $\omega([rtr], \times)$ | DEPLINK $[rtr]$ | * $[RTR \text{ fr}]$ |
|--------------------------------------------------------------------------------------------------------------------------------------------------------|----------------------|---------------------------|-----------------|----------------------|
| a. $\begin{array}{c} [r] \\   \\ \dot{\text{Ṣ}} \text{ a yy aa d} \end{array}$                                                                         |                      | ****!                     |                 |                      |
| b. $\begin{array}{c} [R] \\ / \quad \backslash \\ r \quad r \\   \quad   \\ \dot{\text{Ṣ}} \quad \text{A yy aa d} \end{array}$                         |                      | ***                       | *               |                      |
| c. $\begin{array}{c} [R] \\ / \quad \backslash \\ r \quad r \\   \quad   \quad   \\ \dot{\text{Ṣ}} \quad \text{A yy aa d} \end{array}$                 | *!                   | ***                       | *               |                      |
| d. $\begin{array}{c} [R] \\ / \quad \backslash \\ r \quad r \\   \quad   \quad   \quad   \\ \dot{\text{Ṣ}} \quad \text{A yy aa d} \end{array}$         | *!                   | ***                       | *               | *                    |
| e. $\begin{array}{c} [R] \\ / \quad \backslash \\ r \quad r \\   \quad   \quad   \quad   \quad   \\ \dot{\text{Ṣ}} \quad \text{A yy aa d} \end{array}$ | *!                   | ***                       | *               | *                    |
| f. $\begin{array}{c} [R] \\ / \quad \backslash \\ r \quad R \\   \quad   \quad   \\ \dot{\text{Ṣ}} \quad \text{A YY aa d} \end{array}$                 | *!                   | **                        | **              |                      |
| g. $\begin{array}{c} [R] \\ / \quad \backslash \\ r \quad R \\   \quad   \quad   \quad   \\ \dot{\text{Ṣ}} \quad \text{A yy AA D} \end{array}$         | *!                   | *                         | ***             | *                    |
| h. $\begin{array}{c} [R] \\ / \quad \backslash \\ r \quad R \\   \quad   \quad   \quad   \quad   \\ \dot{\text{Ṣ}} \quad \text{A YY AA D} \end{array}$ | *!                   |                           | ****            | *                    |

We have seen that a high ranked feature co-occurrence constraint prefers blocking. This is the case in rightward spreading in SPalestinian. In leftward spreading, on the other hand, the feature co-occurrence constraint is ranked below the alignment

constraint. This is possible because emphasis spread in SPalestinian involves two different alignment constraints, which differ only in f-precedence relations and their ranking with respect to the feature co-occurrence constraint.

This concludes the analysis of SPalestinian. The contribution of this section is twofold. First, I presented another case of bidirectional spreading, which shows disparities in terms of directionality. In Ikwere (section 4.5), the two directions differ in terms of icy targets; in Somali (section 2.1.3), the two directions differ in terms of domains; in SPalestinian, the two directions differ in terms of blockers. Second, blocking is enforced by feature co-occurrence constraints. These constraints cannot enforce transparency. As we have seen in section 5.5, transparent segments are closely tied to targets and thus to alignment constraints. In particular, transparent segments always form a closed natural class which is determined as the intersection of complements of targeted structures, as defined in (172). Furthermore, transparency exhibits an implicational relationship. That is, transparency of some segments implies transparency of others, but not necessarily vice versa. Blocking does not always exhibit an implicational relationship, and blockers do not necessarily form a closed natural class of segments. This is mirrored in an analysis in which blockers are not enforced by alignment constraints, but instead by feature co-occurrence constraints. In SPalestinian, at least one such constraint is required. Put differently, the prediction of the current approach is that *no constraint* can exclude a single segment from the set of transparent segments, making it a target, while this is not the case for blockers. A single feature co-occurrence constraint cannot make a single segment transparent, but it can make it a blocker. I will now compare transparency and blocking in more detail.

## 6.4 Comparing transparency and blocking

Blockers are similar to transparent segments in that they are not fully associated with a particular feature. A transparent consonant in vowel harmony, for example, is not fully pronounced with the relevant vocalic feature. A blocker, however, represents a further step away from the spreading feature. A blocker is not pronounced with a feature at all. In the current approach, this can be translated into a representational difference between the two non-targets. Transparent segments are d-associated with a feature, while blockers are not associated with a feature at all.

Recall the Strict Locality Condition (142) and the fact that spreading of a feature is not possible across a non-associated root node. Blockers are not associated with the relevant feature and hence terminate spreading. In particular, a blocker cannot be associated with the spreading feature (since that would violate a high

ranked feature co-occurrence constraint), but cannot be skipped either (because of the Strict Locality Condition). This effectively terminates spreading.

I flesh out the effect of feature co-occurrence constraints by comparing RTR harmony in two languages. Wolof will serve as an example of a language with transparent segments, but no blockers. The same two vowels that are transparent in Wolof act as blockers in Yoruba. This difference is attributed to the factorial typology. In Wolof the alignment constraint outranks the relevant feature co-occurrence constraint. This means that spreading trumps the creation of a marked segment. In Yoruba the situation is reversed: the feature co-occurrence constraint outranks the alignment constraint. Since blockers cannot be associated with a feature nor can they be skipped, termination of spreading is the only possible outcome.

### 6.4.1 Wolof

Wolof RTR harmony has been analyzed in section 3.2.3. In this section, I revisit the analysis. The Wolof pattern targets non-high vowels, while consonants and high vowels are transparent. This contrasts with Yoruba, which has a similar vowel inventory in which high vowels act as blockers. Yoruba is discussed in the next section.

Recall that Wolof has root-controlled RTR harmony, as shown in (47) and partially repeated in (183). In (183-a) we see that root vowels determine the prefix vowel: tense root vowels are followed by tense suffix vowels, while lax root vowels are followed by lax suffix vowels. Consonants do not interfere with assimilation, and are transparent. Furthermore, the data in (183-b) reveal that high vowels do not affect the pattern. This suggests that high vowels are transparent.

(183) Wolof tongue root harmony (Ka 1988/1994:13–16,31–35)

|    |                      |                   |                      |                   |
|----|----------------------|-------------------|----------------------|-------------------|
| a. | reer- <u>e</u>       | ‘to be lost in’   | dɛm- <u>ɛ</u>        | ‘to go with’      |
|    | gən- <u>e</u>        | ‘to be better in’ | xam- <u>ɛ</u>        | ‘to know in’      |
|    | ʒeeg- <u>o</u>       | ‘step’            | mɛl- <u>o</u>        | ‘aspect’          |
|    | sofoor- <u>ə</u> m   | ‘his/her driver’  | tɔɔl- <u>ə</u> m     | ‘hie/her field’   |
| b. | toxi- <u>i</u> leen  | ‘go and smoke!’   | soppi- <u>i</u> leen | ‘change!’         |
|    | gəst <u>u</u> -leen  | ‘do research!’    | wat <u>u</u> -leen   | ‘have a haircut!’ |
|    | seenu- <u>u</u> woon | ‘tried to spot’   | tɛɛ <u>u</u> -wɔɔn   | ‘welcomed’        |

In section 3.2.3, I analyzed Wolof as spreading of the feature [rtr]. Spreading in Wolof targets only open vowels. In the present context, this indicates that the alignment constraint contains [rtr] as the spreading feature, [open] as the targeted structure and a Prosodic Word as the domain.

In (184), I adapt the definition to the representational modifications with respect to transparency in section 5.2.1.

- (184) \* $\omega$ ([rtr], open)
- a. \* $\langle$ PWd, [rtr], [open] $\rangle$  /  $\begin{array}{c} \text{PWd} \\ \swarrow \quad \searrow \\ \text{[rtr]} \quad \text{open} \end{array}$
- b. Assign a violation mark for every triplet  $\langle$ PWd, [rtr], [open] $\rangle$ , iff PWd is associated with [rtr] and an *open*-node of [open] and  
[rtr]  $\triangleleft$  *open*.

The alignment constraint outranks the relevant faithfulness constraint DEPLINK[rtr], as already shown in (49). However, the alignment constraint also outranks several feature co-occurrence constraints that penalize lax segments, for example \*[rtr consonant], \*[rtr high], \*[rtr open], \*[rtr vowel]. The effect of these constraints is displayed in tableau (185).

The tableau shows six candidates. Candidate (a) has no spreading and crucially violates the alignment constraint. Candidate (b) has spreading to the only open vowel, and satisfies the alignment constraint. However, spreading also incurs one violation of the faithfulness constraint, because one link to a non-branching rtr-node is added. Furthermore, the three feature co-occurrence constraints are also violated, because the form contains [rtr] vowels and consonants. Spreading always affects a string of segments and cannot skip any segment. This is the case in candidate (c), which is excluded by Gen under the Strict Locality Condition (142). Candidates excluded by Gen are marked by the biohazard sign, ☠.

Candidate (d) has spreading to the open vowel [ε]. However, [ε] is not associated with a non-branching rtr-node, which means that the vowel is transparent rather than a target. Recall that alignment constraints can be satisfied only by a non-branching node, which means that candidate (d) nevertheless violates the alignment constraint. Similarly, the faithfulness constraint is not violated, because only non-branching nodes can violate DEPLINK[f] and MAXLINK[f] constraints. Spreading violates the feature co-occurrence constraints, regardless of whether the resulting segments are transparent or targets. As we have seen in the previous section, d-association to a target or beyond the final target is never preferred. A candidate with spreading without a target will violate the alignment constraint as many times as the candidate without spreading (since d-association never satisfies alignment). In addition, the candidate with spreading will also violate feature co-occurrence constraints, which means that it will be harmonically bounded by the faithful candidate. Candidate (d) is harmonically bounded by candidate (a).

(185) tɛkki-lɛn ‘untie!’

|    | $\begin{array}{c} [r] \\ / t \ \varepsilon \ k: \ i \ l \ \varepsilon: \ n / \\ [o] \quad [o] \end{array}$                      | $*\omega([rtr],op)$ | DEPLK[rtr] | $*[rtr \ cons]$ | $*[rtr \ hi]$ | $*[rtr \ op]$ |
|----|---------------------------------------------------------------------------------------------------------------------------------|---------------------|------------|-----------------|---------------|---------------|
| a. | $\begin{array}{c} [r] \\ t \ \varepsilon \ k: \ i \ l \ \varepsilon: \ n \\ [o] \quad [o] \end{array}$                          | *!                  |            |                 |               | *             |
| b. | $\begin{array}{c} [R] \\ r \\ r \\ r \\ r \\ r \\ t \ \varepsilon \ k: \ i \ l \ \varepsilon: \ n \\ [o] \quad [o] \end{array}$ |                     | *          | **              | *             | **            |
| c. | $\begin{array}{c} [R] \\ r \\ r \\ t \ \varepsilon \ k: \ i \ l \ \varepsilon: \ n \\ [o] \quad [o] \end{array}$                | Ruled               | out        | by              | SLC           | (142)         |
| d. | $\begin{array}{c} [r] \\ r \\ r \\ r \\ r \\ r \\ t \ \varepsilon \ k: \ i \ l \ \varepsilon: \ n \\ [o] \quad [o] \end{array}$ | *!                  |            | **              | *             | **            |
| e. | $\begin{array}{c} [R] \\ r \\ R \\ r \\ r \\ t \ \varepsilon \ k: \ i \ l \ \varepsilon: \ n \\ [o] \quad [o] \end{array}$      |                     | **!        | **              | *             | **            |
| f. | $\begin{array}{c} [R] \\ R \\ R \\ R \\ R \\ r \\ t \ \varepsilon \ k: \ i \ l \ \varepsilon: \ n \\ [o] \quad [o] \end{array}$ |                     | **!*       | **              | *             | **            |

In candidates (e) and (f) the feature [rtr] targets other vowels. This creates additional (and fatal) violations of DEPLINK[f]. Note also that candidates (b) and (d–f) violate the feature co-occurrence constraints the same number of times. This

is because these constraints are equally violated by targets and transparent segments.

This concludes the analysis of Wolof vowel harmony. Wolof exhibits root-controlled laxing harmony, which targets only open vowels. Transparency of consonants and high vowels is achieved by a ranking of one alignment constraint above faithfulness, feature co-occurrence and other alignment constraints. In the next section we will see that when the feature co-occurrence constraints outrank the alignment constraint, the result is blocking.

### 6.4.2 Yoruba

Standard Yoruba also displays vowel harmony. The pattern is in many ways similar to Wolof. For example, both languages have one set of high vowels. However, there are a few significant differences. In particular, high vowels in Wolof are transparent, while in Yoruba they are blockers. Following the previous proposals by other phonologists, I show that this difference stems directly from the ranking of alignment constraints with respect to feature co-occurrence constraints.

In (186) we see the distribution of tense and lax vowels in Yoruba (Bamgboṣe 1966, 1967; Awobuluyi 1967; Awobuluyi & Bamgboṣe 1967; Archangeli & Pulleyblank 1989, 1994; Pulleyblank 1996; Baković 2000; Krämer 2003, among many others). Within roots (186-a), all mid vowels are either tense or lax. The observations regarding root vowels can be extended to the relationship between roots and prefixes. In (186-b) we see the agentive/instrumental prefix, which alternates between [o] and [ɔ]. A root with tense vowels is preceded by a tense prefix vowel. Similarly, a root with lax vowels is preceded by a lax prefix vowel. This suggests that the relevant feature originates from some vowel of the root and spreads to all other vowels. I will assume that it is the final root vowel that acts as a trigger. Triggers in other positions will be considered for Twi in section 9.5.2, and the same approach can be straightforwardly extended to Yoruba.

(186) Yoruba mid vowels (Awobuluyi 1967:2–4; Archangeli & Pulleyblank 1989: 177; Pulleyblank 1996:297,306)

|    |     |                 |     |                |
|----|-----|-----------------|-----|----------------|
| a. | ege | ‘dirge’         | εge | ‘casava’       |
|    | eke | ‘lie’           | εke | ‘forked stick’ |
|    | ese | ‘cat’           | εse | ‘row’          |
|    | ebe | ‘heap for yams’ | εko | ‘pap’          |
|    | ole | ‘thief’         | ɔbe | ‘soup’         |
|    | owo | ‘money’         | ɔko | ‘vehicle’      |



|    |      |                  |        |                      |
|----|------|------------------|--------|----------------------|
| b. | ḵewe | ‘publish a book’ | ɔ-ḵewe | ‘publisher’          |
|    | ḵowu | ‘be jealous’     | ɔ-ḵowu | ‘jealous person’     |
|    | kɔse | ‘refuse’         | ɔ-kɔse | ‘person who refuses’ |
|    | ḵeũ  | ‘eat’            | ɔ-ḵeũ  | ‘glutton’            |

There is only one low vowel [a], which does not alternate. In (187-a), we see that root-initially, the low vowel can co-occur with tense or lax vowels. However, when [a] is preceded by another root vowel, this other vowel is always lax (187-b). Not attested are the roots with a tense mid vowel followed by a low vowel. This also extends to prefixes, which are always lax, if followed by [a]. These three distributional facts concerning the low vowel seem puzzling at first. However, what this actually suggests is that the pattern involves leftward RTR harmony, and [a] is also associated with [rtr]. The feature [rtr] spreads from [a] leftward, which means that all preceding vowels will be [rtr], as attested. There are forms like [ɛgba] ‘whip, but no forms like \*[ɛgba]. In contrast, the vowels *following* [a] can be tense, because [rtr] does not spread from [a] rightwards. Furthermore, the vowels following [a] can also be lax, because they may have the feature [rtr] underlyingly. This explains why both [atɛ] ‘wares’ and [atɛ] ‘hat’ are attested.

(187) Yoruba low vowel (Awobuluyi 1967:2–4; Archangeli & Pulleyblank 1989: 211; Pulleyblank 1996:306,311)

|    |                                    |                  |        |
|----|------------------------------------|------------------|--------|
| a. | Root-initial                       |                  |        |
|    | atɛ                                | ‘wares’          | atɛ    |
|    | aḵɛ                                | ‘witch’          | afe    |
|    | abɛrɛ                              | ‘needle’         | awo    |
|    | agbɔ                               | ‘coconut’        |        |
| b. | Root-final                         |                  |        |
|    | ɛba                                | ‘type of food’   | *ɛba   |
|    | ɛgba                               | ‘whip’           | *ɛgba  |
|    | ɛḵa                                | ‘fish’           | *ɛḵa   |
|    | ɔḵa                                | ‘market’         | *ɔḵa   |
| c. | Prefix followed by a root with [a] |                  |        |
|    | ta                                 | ‘shoot’          | ɔ-ta   |
|    | laḵu                               | ‘open eyes’      | ɔ-laḵu |
|    | dale                               | ‘be treacherous’ | ɔ-dale |

Another issue concerns the high vowels. The data in (188-a) reveal that high vowels can only be preceded by tense prefixes (while they can be followed by any vowel). The same is true for distribution within roots (188-b): only tense vowels can precede high vowels. This is consistent with the above generalization that only the rightmost root vowel acts as a trigger of RTR harmony and that

spreading is blocked by high vowels. In the light of this conclusion, the restriction on initial vowels makes sense: since [rtr] cannot spread across high vowels, initial vowels surface without this feature. The additional assumption I am making here is that prefixes cannot surface with their underlying [rtr]. I acknowledge that this is not a trivial assumption, but it is nevertheless beyond the scope of the current discussion. This issue is fully addressed in chapter 9, where I attribute this effect to positional faithfulness, which is needed *in addition* to alignment constraints. The effect is demonstrated on Twi vowel harmony (section 9.5.2).

(188) Yoruba high vowels (Awobuluyi 1967:2–4; Archangeli & Pulleyblank 1989: 184,210,211; Pulleyblank 1996:306,311)

a. No spreading to prefixes

|     |                  |         |                    |
|-----|------------------|---------|--------------------|
| pin | ‘come to an end’ | o-pin   | ‘end, termination’ |
| ku  | ‘die’            | o-ku    | ‘human remains’    |
| ifɛ | ‘work’           | o-f-ifɛ | ‘workman’          |
| ifɛ | ‘message’        | o-f-ifɛ | ‘messenger’        |
| ika | ‘cruelty’        | o-f-ika | ‘cruel person’     |
| ija | ‘punishment’     | o-f-ija | ‘victim’           |

b. No spreading across a high vowel

|                |               |                 |
|----------------|---------------|-----------------|
| ew <u>u</u> ɛ  | ‘goat’        | *ɛw <u>u</u> ɛ  |
| el <u>u</u> bɔ | ‘yam flour’   | *ɛl <u>u</u> bɔ |
| ok <u>u</u> rɔ | ‘palm kernel’ | *ɛk <u>u</u> rɔ |
| or <u>u</u> kɔ | ‘name’        | *ɛr <u>u</u> kɔ |
| er <u>u</u> pɛ | ‘earth’       | *ɛr <u>u</u> pɛ |
| od <u>i</u> dɛ | ‘Grey Parrot’ | *ɛd <u>i</u> dɛ |

To summarize, Yoruba shows RTR spreading from the final root vowel (or from any [a]), which targets only open vowels. High vowels block spreading, while consonants never interfere and are always transparent. Yoruba resembles Wolof in many ways. Both languages exhibit unidirectional RTR spreading that does not target high vowels or consonants. This suggests that the same kinds of constraints are active in both languages. Furthermore, both languages show no alternations in high vowels. On the other hand, the two languages also differ from one another. First, Wolof shows rightward spreading to suffixes, while Yoruba shows leftward spreading to prefixes. This shows that while the alignment constraints in both languages may involve the same type of segments, the f-precedence relations are reversed. Second, the high vowels are transparent in Wolof, while they are blockers in Yoruba. This difference in blocking will be accounted for by different ranking between feature co-occurrence constraints and alignment constraints. Such an analysis is entirely in line with the previous accounts (e.g. Pulleyblank 1996; Baković 2000).

Third, the low vowel alternates in Wolof, while it always remains lax in Yoruba, and triggers spreading. This can be accounted for by a high ranked constraint against tense low vowels. Such constraint can be phonetically grounded and there are several ways to formalize it (see Archangeli & Pulleyblank 1994; Flemming 2001, 2004 for proposals along these lines). The simplest would be by a co-occurrence constraint \*[low atr]. Another way would be by a positive constraint (if [low], then not [rtr]).

Recall section 3.2 and the fact that RTR spreading reveals several patterns. In languages like SPalestinian, spreading is to all segments. Twi, on the other hand, shows spreading only to vowels, and Wolof shows spreading to open vowels. This restriction is enforced by alignment constraints, which have a root node (SPalestinian), a vowel (Twi) or [open] (Wolof) as the targeted structure. The fact that [rtr] prefers spreading to [open] vowels rather than [high] vowels is phonetically grounded (Archangeli & Pulleyblank 1994). In Yoruba, only mid vowels are targeted overtly, and low vowels do not alternate, so it is not clear whether they undergo the process or not.

Perhaps the most obvious solution to these data from Yoruba would be to posit an alignment constraint that has a feature common to mid vowels, [mid] (as proposed for Yaka vowel harmony by Hyman 1998:43ff.). The problem with such a constraint is that it puts the proposed phonetic and typological grounding of alignment constraints in jeopardy. If [rtr] prefers open vowels, it should not prefer mid vowels to low vowels, but rather the other way around. I instead propose that the active alignment constraint in Yoruba has the same targeted structure as in Wolof, namely the one that has [open] as the targeted structure. This implies that low vowels are also targeted. We know that low vowels are fully associated with the feature, since they trigger spreading to preceding mid vowels. As we have seen in many previous examples, the targeted structure of the alignment constraint cannot be larger than the set of all segments excluding the transparent segments. In Wolof, consonants and high vowels are transparent, but not open vowels, which means that all segments with [open] are targeted. In Yoruba, consonants are also transparent, but not high vowels, which suggests that both [open] or [vowel] are appropriate targeted structures. I choose the former to allow for a direct comparison with Wolof, but the latter is completely sufficient. Note that a similar solution is likely possible for other languages that distinguish [rtr] in mid vowels, but not in high or low vowels (see Archangeli & Pulleyblank 1994; Casali 2008 for a review).

I now demonstrate the Yoruba ranking in two steps. I first discuss a candidate with open vowels (189), followed by a candidate with a high vowel that displays blocking (190).

In (189) we see an input with only open vowels. As discussed above, the Yoruba ranking is in many ways similar to the ranking in Wolof. The relevant alignment constraint outranks the faithfulness constraint  $\text{DEPLINK}[\text{rtr}]$  and two feature co-occurrence constraints,  $*[\text{rtr consonant}]$ ,  $*[\text{rtr open}]$ . Wolof and Yoruba differ in the directionality of spreading, which is mirrored by the opposite f-precedence relations between the two features of alignment constraints. While Wolof requires  $*\omega([\text{rtr}], \text{open})$  in (184), Yoruba requires  $*\omega(\text{open}, [\text{rtr}])$ .

Candidate (189-a) has no spreading and fatally violates  $*\omega(\text{open}, [\text{rtr}])$ . Candidate (b) wins, as it has  $[\text{rtr}]$  fully associated with all  $[\text{open}]$  targets. Candidate (c) shows d-association, which cannot satisfy alignment constraints. Candidate (d) has total spreading and violates  $\text{DEPLINK}[\text{rtr}]$  four times, which is more violations than the winning candidate. Notice that candidates (b–d) have the same number of violation marks on both feature co-occurrence constraints. This is because all segments are associated with  $[\text{rtr}]$ , and full association and d-association fare equally on feature co-occurrence constraints.

(189) ɔkɔsɛ ‘person who refuses’

|                                                                                      | $\begin{array}{c} [r] \\ / \text{ ɔ } - \text{ k } \text{ ɔ } \text{ s } \text{ ɛ } / \\ [o] \quad [o] \quad [o] \end{array}$                     | $*\omega(\text{op}, [\text{rtr}])$ | DEPLK[rtr] | $*[\text{rtr cons}]$ | $*[\text{rtr op}]$ |
|--------------------------------------------------------------------------------------|---------------------------------------------------------------------------------------------------------------------------------------------------|------------------------------------|------------|----------------------|--------------------|
| a.                                                                                   | $\begin{array}{c} \text{ ɔ } \quad \text{ k } \quad \text{ ɔ } \quad \text{ s } \quad \text{ ɛ } \\ [o] \quad [o] \quad [o] \end{array}$          | $*!*$                              |            |                      | *                  |
| b.  |                                                                                                                                                   | **                                 | **         | ***                  |                    |
| c.                                                                                   | $\begin{array}{c} [r] \\ / \text{ ɔ } \quad \text{ k } \quad \text{ ɔ } \quad \text{ s } \quad \text{ ɛ } \\ [o] \quad [o] \quad [o] \end{array}$ | $*!*$                              |            | **                   | ***                |
| d.                                                                                   | $\begin{array}{c} [R] \\ / \text{ ɔ } \quad \text{ k } \quad \text{ ɔ } \quad \text{ s } \quad \text{ ɛ } \\ [o] \quad [o] \quad [o] \end{array}$ |                                    | ***!*      | **                   | ***                |

Tableau (190) shows the blocking effect. Blockers lack the spreading feature and thus do not violate any feature co-occurrence constraint with the spreading feature. The relevant constraint is  $*[\text{rtr high}]$ . We have seen (185) that in Wolof this constraint is ranked below the alignment constraint; it is more important to spread the feature than to satisfy the constraint  $*[\text{rtr high}]$ , which is violated by a transparent high vowel. The situation in Yoruba is the opposite. The constraint  $*[\text{rtr high}]$  is ranked above the alignment constraint, the resulting high vowel cannot be associated with [rtr], and hence blocks spreading.

The winning candidate (190-a) has no spreading, although it violates  $*\omega(\text{open}, [\text{rtr}])$ . Candidate (b) has spreading all the way to the blocking high vowel. The added association line leads to the violation of a low ranked feature co-occurrence constraint. Candidate (c) contains skipping of segments, which is ruled out by the Strict Locality Condition (142). The remaining candidates (d–g) all contain a high

vowel that is associated with [rtr], violating the dominant constraint \*[rtr hi]. This constraint is violated equally by transparent segments and full targets. Note also that the alignment constraint could be easily replaced by \* $\omega$ (vowel, [rtr])—which has a vowel as the targeted structure—yet the winner would remain the same.

(190) of*i*ε ‘workman’

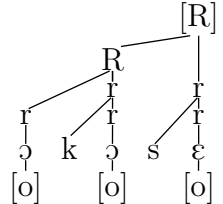
|    | $\begin{array}{c} / \text{ } \underset{[o]}{\text{o}} \text{ - f - i f } \underset{[o]}{\text{ } \overset{[r]}{\text{ } \varepsilon} } / \\ \text{[o]} \qquad \qquad \qquad \text{[o]} \end{array}$ | *[rtr hi] | * $\omega$ (op,[rtr]) | DEPLK[rtr] | *[rtr cons] | *[rtr op] |
|----|-----------------------------------------------------------------------------------------------------------------------------------------------------------------------------------------------------|-----------|-----------------------|------------|-------------|-----------|
| a. |                                                                                                                                                                                                     |           | *                     |            |             | *         |
| b. |                                                                                                                                                                                                     |           | *                     | *!         |             | *         |
| c. | Ruled                                                                                                                                                                                               | out       | by                    | SLC        | (142)       |           |
| d. | *!                                                                                                                                                                                                  |           | *                     | **         | **          | **        |
| e. | *!                                                                                                                                                                                                  |           | **                    | **         | **          | ***       |
| f. | *!                                                                                                                                                                                                  |           | *                     | **         | **          | ***       |
| g. | *!                                                                                                                                                                                                  |           | ****                  | **         | **          | ***       |

The present analyses of Wolof and Yoruba follow the main idea of the proposals found in the literature (see references above). The aim of this section was not to come with an entirely new analysis of these two well known cases of vowel harmony, but rather to make the differences between the two languages clear in the current framework. A comparison of Wolof and Yoruba revealed the crucial disparities between transparent segments and blockers. In terms of representations, transparent segments may be d-associated with the spreading feature (when they are between a trigger and a target). Blockers, on the other hand, can never be d-associated with the spreading feature. This is mirrored by constraints: if a particular segment is transparent, it violates at least one more feature co-occurrence constraint compared to a blocker. On the other hand, alignment constraints are not violated by transparent segments (if they do not contain the targeted structure), while blockers may violate the constraint themselves (if they are associated with the targeted structure) and may cause further violations due to other targets which cannot be reached. Two rankings are possible. When alignment outranks the relevant feature co-occurrence constraint, transparency is preferred. When the ranking is reversed, blocking wins.

The current approach differs significantly from any previous approaches which assumed that transparent segments and blockers fare equally on feature co-occurrence constraints. This is not the case in BDT, where some feature co-occurrence constraints are violated by transparent segments, but not by blockers. In what follows, I reexamine transparency from this perspective. In particular, I show that feature co-occurrence constraints *never* prefer transparency and hence cannot interfere with the factorial typology of targets predicted by alignment and faithfulness constraints.

### 6.4.3 Factorial typology

One prediction of an approach that builds on alignment constraints with different targeted structures is that targets display an implicational relationship. That is, spreading to some segments implies spreading to other segments. In section 3.2, I provided a case study of RTR harmony in order to demonstrate this fact. Languages show an implicational pattern in which spreading to consonants implies spreading to vowels, but not the reverse. There is no language that would spread [rtr] to consonants and not to all vowels.

Now that we have seen cases of blocking and the effect of feature co-occurrence constraints, we can make this claim even more accurate. In particular, it is transparent segments that exhibit the implicational pattern, while targets may or may not. In the reviewed cases of RTR harmony, both types of segments behave this way. The statement “spreading to consonants implies spreading to high vowels, which implies spreading to open vowels” is empirically equivalent to “transparent

high vowels imply transparent consonants”. However, these two statements can be distinguished once we consider the effect of feature co-occurrence constraints. According to the present approach, feature co-occurrence constraints are equally violated by transparent segments and targets. In other words, feature co-occurrence constraints never prefer transparency over targets. The only reason why segments surface as targets rather than being transparent is because of alignment constraints and their ranking with respect to the faithfulness constraint DEPLINK[f].

Recall tableau (54), which showed the factorial typology of RTR spreading based on different alignment constraints and faithfulness constraints. At the time, the effect of feature co-occurrence constraints was not yet considered. The typological observations regarding RTR spreading were: spreading to open vowels is preferred to high vowels and consonants. There is no language that would have spreading to consonants and not to all vowels. In the light of the distinction between transparent segments and blockers, we need to slightly modify this statement: transparent high vowels imply transparent consonants. There is no language with open vowels, but no consonants, transparent to RTR.

Tableau (191) shows all possible outputs of RTR spreading (without segmental blockers). Seven candidates are shown, of which only three are attested. Candidate (a) has spreading to open vowels, but high vowels and consonants remain transparent. This is attested in Wolof (sections 3.2.3 and 6.4.1). Candidate (d) has spreading to all vowels, while consonants are transparent. This is attested in Twi (section 3.2.2). Finally, candidate (g) has spreading to all segments, as attested in Southern Palestinian Arabic (section 3.2.1). All other candidates are unattested. We have already seen in tableau (54) that alignment and faithfulness constraints alone cannot generate these unattested patterns, no matter how they are ranked.



(191) Factorial typology for RTR spreading is not affected by feature co-occurrence constraints

| $\begin{array}{c} [r] \\ / \times e k i \times / \end{array}$                          | * $\omega$ ([rtr], open) | * $\omega$ ([rtr], vowel) | * $\omega$ ([rtr], $\times$ ) | DEPLINK[rtr] | * $\omega$ ([rtr], vowel) | * $\omega$ ([rtr], high) | * $\omega$ ([rtr], open) | * $\omega$ ([rtr], cons) |
|----------------------------------------------------------------------------------------|--------------------------|---------------------------|-------------------------------|--------------|---------------------------|--------------------------|--------------------------|--------------------------|
| a.    |                          | i k i                     | **                            |              | ε i                       | i                        | ε k                      |                          |
| b.    |                          | e e e k                   | **                            |              | e i                       | i                        | e k                      |                          |
| c.   |                          | e e i e i                 | **                            |              | e i                       | i                        | e K                      |                          |
| d.  |                          | k                         | ***                           |              | ε i                       | i                        | ε k                      |                          |
| e.  |                          | i i                       | ***                           |              | ε i                       | i                        | ε K                      |                          |
| f.  |                          | e e e                     | ***                           |              | e i                       | i                        | e K                      |                          |
| g.  |                          |                           | ****                          |              | ε i                       | i                        | ε K                      |                          |

Tableau (191) demonstrates that adding feature co-occurrence constraints does not negate this generalization. Recall that feature co-occurrence constraints are violated equally by transparent segments and targets. All candidates below contain only transparent segments or targets, violating the feature co-occurrence constraints the same number of times. In other words, while high ranked feature co-occurrence constraints may cause blocking, they cannot prefer transparent segments over targets. For example, candidate (c) with transparent vowels but targeted consonants is harmonically bounded. This prediction of the present approach is desirable, since candidate (c) is unattested.

Before I conclude, I would like to address one remaining issue. The committee points out that in most approaches transparent segments are more marked than targets. That is to say, a transparent segment violates some markedness constraint that a target does not. Examples of such constraints include NOGAP[f] (Kirchner 1993; Itô et al. 1995) and EXPRESS[f] (Kisseberth 1994; Cole & Kisseberth 1995a,b; Cassimjee & Kisseberth 1998). A target never violates these constraints. The challenge of these alternative constraints is that they treat all transparent segments as equally marked. At the same time, feature co-occurrence constraints are employed to get the difference between the relative markedness among the different transparent segments. However, transparent segments behave differently from blockers. For example, in [rtr] harmony transparent consonants imply transparent high vowels but not vice versa. This is not the case for blockers: as we have seen in Yoruba, only high vowels block [rtr] harmony, but consonants do not. In what follows, we will examine two more instances of such discrepancies between transparent segments and blockers (vowel and nasal harmony). To illustrate, we will see that nasal harmony allows all sorts of blockers, but only transparent obstruents. The approach based solely on a constraint against transparent segments and feature co-occurrence constraint cannot exclude transparent sonorants, which can be achieved in the current framework.

BDT treats transparency in a fundamentally different way than blocking. First, transparency is relatively marked. This relative markedness is captured by alignment constraints, which make a direct connection between the spreading feature and its transparent segments. With respect to a particular spreading feature, some transparent segments are more marked than others. Put differently, some transparent segments imply others. For example, alignment constraints with [rtr] as the spreading feature target all root nodes, vowels or open vowels. Respectively, no segments, consonants, or consonants and high vowels are transparent. The generalization is that transparent high vowels imply transparent consonants, but not vice versa. From the perspective of [rtr] as the spreading feature, one could say that high vowels are more marked transparent segments than consonants. In the

current approach, such markedness of transparent segments (compared to targets) has to do with the interaction of alignment and DEPLINK[rtr].

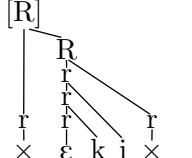
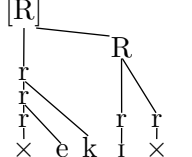
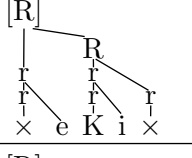
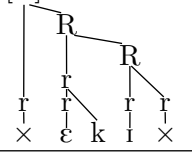
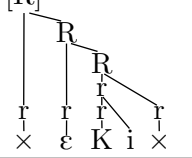
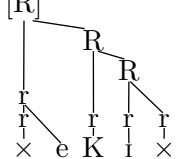
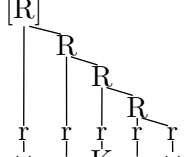
Second, blocking is attributed to feature co-occurrence constraints which can be ranked independently of transparent segments. In the analysis of Yoruba, for example, we have seen that \*[rtr high] needs to be ranked above \*[rtr consonant], as only high vowels (but not consonants) block harmony. The ranking of these constraints cannot be used to explain why consonants are transparent to [rtr] harmony in Yoruba, but high vowels are not. In short, transparency and blocking are independent of one another and need two separate accounts, as it is the case in BDT.

To summarize, I have shown that feature co-occurrence constraints in BDT do not prefer transparent segments over targets. This means that they never interfere with the factorial typology concerning the relationship between transparent segments and targets. The main objective of this thesis is to come up with a way to restrict locality of feature spreading. I propose a solution that relies on alignment constraints. More specifically, the locality facts are attributed to the relationship between a particular spreading feature and its possible targeted structures. This relationship may be phonetically grounded, yet it must be ultimately confirmed typologically. I have demonstrated this for RTR spreading in section 3.2. This section shows that feature co-occurrence constraints cannot negate the predictions of alignment constraints.

There are at least two reasons why the current approach is superior to the previous proposals. First, feature co-occurrence constraints in BDT can never make a single segment transparent. Such unattested patterns can be replicated by other approaches. Second, transparency and blocking need two separate accounts. This is because most assimilation patterns show a different set of transparent segments compared to a set of blockers. Most approaches use a single constraint family (such as feature co-occurrence constraints) for both, which fails to capture the attested differences. In what follows, I demonstrate this point for the behavior of consonants in vowel harmony and tone spreading (section 6.5), followed by a cross-linguistic study of transparency and blocking in nasal harmony (section 6.6).

## 6.5 Blocking by consonants

So far, we have seen that blocking differs greatly from transparency in terms of representations and typological predictions. As regards the former, blockers are not associated with the spreading feature, while transparent segments are d-associated with the feature. As regards the latter, only transparency displays implicational characteristics. In the case of RTR harmony, for example, transparent high vowels imply transparent consonants (as in Wolof), but not the reverse. In other words,

while there are languages that have transparent consonants and high vowels, there is no language that has transparent high vowels, but not consonants. One way of capturing this generalization is by alignment constraints that refer to different targeted structures. In particular, there are alignment constraints with [rtr] as the spreading feature, and a root node, a vowel or [open], as the targeted structure, but there are no constraints that can have consonants as the targeted structure. In (54), I have demonstrated that under no ranking can such universal constraints generate unattested languages with consonants as targets and vowels as transparent. In (191), I have further shown that no other constraint—including faithfulness constraints and feature co-occurrence constraints—can exclude a segment from the set of targets. For example, even though the constraint \*[rtr open] is a valid constraint, it cannot enforce a low vowel to be transparent in RTR harmony, since transparent segments violate this constraint just as much as targets. This is a welcome prediction. Thus, the only way a transparent segment can surface is due to an alignment constraint that prefers a distant target. We can conclude that transparent segments are restricted and show a hierarchical structure.

Blockers, on the other hand, may or may not show such an implicational relationship. In Yoruba, as we have seen in section 6.4.2, only high vowels act as blockers, while consonants do not. We could easily imagine another language in which other segments block [rtr] spreading. This situation is found in SPalestinian, where only front segments block spreading (section 6.3). In this section, I review blocking of two types of assimilation by consonants. First, I review blocking of vowel harmony by consonants (section 6.5.1). I show that the subsets of blockers found in different languages display no implicational relationship. More specifically, some block vowel harmony in one language, while others block it in another. This is entirely consistent with the current approach in which blocking is enforced by feature co-occurrence constraints, each of which can be ranked above or below alignment. Second, I extend blocking to tone spreading (section 6.5.2). Unlike the patterns observed in vowel harmony, blocking of tone spreading by consonants displays great regularity and no known exceptions.

### 6.5.1 Vowel harmony

The point that transparency in vowel harmony can be achieved by an alignment constraint in combination with faithfulness constraints has been demonstrated several times. In Finnish (171) for example, an alignment constraint prefers spreading to vowels, while the faithfulness constraint prefers minimal spreading. Hence, no spreading to consonants is found. In Wolof (185), the situation is similar: an alignment constraint prefers spreading to open vowels, while the faithfulness constraint prefers minimal spreading. Hence, no spreading to consonants or closed vowels is found. This prediction has been thoroughly investigated in sections 3.2 and 6.4.3.

| TYPE       | BLOCKER                         | EXAMPLE LANGUAGE                                                |
|------------|---------------------------------|-----------------------------------------------------------------|
| Front/back | k                               | Turkish (Clements & Sezer 1982),<br>Finnish (Kiparsky 1981)     |
|            | l̥, r̥, k̥<br>sonorants         | Turkish (Clements & Sezer 1982)<br>Shona (Uffmann 2006)         |
| Round      | C <sup>w</sup> , labial C       | Nawuri (Casali 1995)                                            |
|            | w                               | Bashkir (Poppe 1962)                                            |
| Open       | voiced obstruents               | Buchan Scots (Paster 2004)                                      |
| ATR        | C <sup>w</sup> , C <sup>j</sup> | Akan (Clements 1976/1980, 1985a)                                |
|            | glides                          | Turkana (Dimmendaal 1983; Noske 1990, 2000)                     |
|            | nasals                          | Assamese (Mahanta 2007)                                         |
| Vowel copy | glides                          | Ainu (Itô 1984)                                                 |
|            | non-laryngeal C                 | Chemehuevi, Arbore, Yapese,<br>Yokuts, Wichita (Steriade 1987a) |
|            | sonorants                       | Yucatec Maya (Krämer 2001)                                      |

Table 6.1: Consonant blockers in vowel harmony

Blocking, on the other hand, does not have the same character. Often, we find different (even disjunctive) sets of segments blocking the same kind of harmony. This can be attributed to feature co-occurrence constraints that can refer to different combinations of features. A ranking of several feature co-occurrence constraints above the alignment constraint is entirely possible. A related issue is that segments that block spreading of a particular feature are often not the same segments that are also transparent, as we have seen in the case of RTR harmony.

I now extend these findings to vowel harmony. We have already seen a language that shows blocking of vowel harmony by a vowel. In section 6.4.2, I analyzed Yoruba, in which high vowels block RTR harmony. Here I turn to languages in which a consonant blocks vowel harmony. These languages seem exceedingly rare. Often, a small set of consonants block harmony. Table 6.1 summarizes the known cases of vowel harmony blocked by consonants. Many of these impose further prosodic restrictions on blockers. In this already lengthy thesis, I will only discuss a very limited prosodic effect on blockers, the rest are left for further research.

In Table 6.1 we see five different vowel harmonies. For the most part, blockers appear to be phonetically related to the spreading feature. For example, Turkish has front/back harmony. If analyzed as back harmony, palatalized (or front) consonants block spreading. Upon closer inspection, however, the blocking pattern becomes much less systematic. Turkish also has [g<sup>j</sup>] in its inventory, which

does not block spreading (Clements & Sezer 1982). This suggests that blocking resembles transparency in some way, but typically shows exceptionality in that not all segments that form a strict natural class necessarily exhibit consistent blocking. Perhaps the most compelling case of blocking is lowering harmony in Buchan Scots, which is blocked by voiced obstruents (Paster 2004). Obstruent voicing has no straightforward connection to vowel height.<sup>2</sup>

Even without examining these cases in detail, we can see that consonant blocking of vowel harmony is an underreported and rare phenomenon. Nevertheless, blocking by consonants is attested. The reported cases reveal that blocking is often phonetically grounded. For example, a palatalized consonant may block back harmony, as in Turkish, or a labial blocks rounding as in Nawuri.

The current model does not restrict blocking in any way, since any feature co-occurrence constraint can be ranked above an alignment constraint. One way to offer an implicational relationship between a spreading feature and its blocking feature is by proposing a fixed ranking of feature co-occurrence constraints. In section 6.6.1, we will see such an approach in nasal harmony. An alternative solution would be to say that feature co-occurrence constraints are in a stringency relationship. I stop short of proposing any solution. This is because the implicational relationship among blockers is not always as clear as among transparent segments.

### 6.5.2 Tone spreading

In the previous sections of this chapter, I claimed that blocking is phonetically grounded, but the connection between the spreading feature and its blockers is not as predictable as the relationship between the spreading feature and transparent segments. I now present a case where it seems that the blocking patterns are consistent.

The particular example I will be looking at is tone spreading blocked by obstruents. Unlike blocking of obstruents in vowel harmony, blocking in tonal spreading is well studied (Schuh 1978; Bradshaw 1997, 1999; Tang 2008; Lee 2008). Both the typological generalizations and the underlying phonetic mechanisms are well understood (Hyman & Schuh 1974, Hombert 1978, Hombert et al. 1979). Here I focus on the distinction between voiced and plain (voiceless unaspirated) obstruents. Without exceptions, voiced obstruents prefer low tone, while plain obstruents prefer high tone. I leave out other phonation types (such as implosives, breathy voice, glottal stop etc.), because my main point is to illustrate how consonant-

---

<sup>2</sup>See Youssef (2010) for an alternative analysis, which argues that Buchan is a case that involves consonant-vowel interactions. In particular, he argues that Buchan is a case of raising (rather than lowering) triggered by consonants (rather than by stressed vowels).

tone interactions can be captured using the current representational account and constraints.

Here I discuss one example of blocking. Western Bade (henceforth, Bade; Lee 2008:27–28) shows tone spreading from the subject clitic to the verb. In (192) we see two types of subject clitics. The first column contains a low toned clitic followed by a verb (I mark only high tones, the rest of the vowels are low). The second column, however, shows a high toned clitic followed by the same verbs. We can see that H spreads until it encounters another H on the final syllable of the verb. While voiceless obstruents, glottalized obstruents and all sonorants allow H tone spreading, voiced obstruents (including prenasalized stops) block H tone spreading. For example, the H tone in ‘I pushed’ spreads from the clitic only to the first syllable [ná tǎmbəlú], but not to the second \*[ná tǎmbǎ́lú]. Spreading is blocked by the voiced (prenasalized) stop.

- (192) H tone spreading in Bade (Lee 2008:27–28)
- | 1P.PL      | 1P.SG       |           |
|------------|-------------|-----------|
| jə tǎnkəkú | nó tǎnkǎ́kú | ‘pressed’ |
| jə tǎmbəlú | nó tǎmbǎ́lú | ‘pushed’  |
| jə məskətú | nó məskǎ́tú | ‘turned’  |
| jə ɓazartú | nó ɓazartú  | ‘shamed’  |

This kind of blocking is very common. Voiced obstruents frequently block spreading of high tones, while plain obstruents block spreading of low tones. Schuh (1978), Bradshaw (1997), Bradshaw (1999), Tang (2008), Lee (2008) provide numerous other cases of similar patterns. Here, I account for the Western Bade pattern.

As we have seen above, High tone spreads from the clitic to the root. This spreading targets all following tone bearing units. Here I assume these are vowels.<sup>3</sup> The active alignment constraint has a prosodic word as the domain, High tone as the spreading feature, and vowel as the targeted structure. The targeted structure must not f-precede the spreading feature. The alignment constraint \* $\omega$ ([h], vowel) is defined in (193).

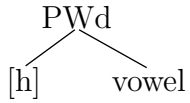
- (193) \* $\omega$ ([h], vowel)
- a. \* $\langle$ PWd, [h], [vowel] $\rangle$  / 
- b. Assign a violation mark for every triplet  $\langle$ PWd, [h], [vowel] $\rangle$ , iff PWd is associated with [h] and a vowel-node of [vowel]

---

<sup>3</sup>An alternative would be to assume that spreading targets prosodic constituents such as syllables or moras. This alternative is also allowed in the current approach based on alignment, because the targeted structure can also be a prosodic constituent, as in (37).

and  
[h]  $\triangleleft$  *vowel*.

In Bade, High tone spreading is blocked by voiced obstruents. In the current context, this can be attributed to the feature co-occurrence constraint \*[h voice obstruent] (Tang 2008; Lee 2008, among many others).<sup>4</sup> The feature [obstruent] is a privative correspondent of [–sonorant] (Lombardi 1995a, 1999). Only voiced obstruents violate the constraint \*[h voice obstruent], whereas voiced sonorants and voiceless segments do not. In this thesis, I make no assumptions as to whether or not sonorants (including vowels) have the [voice] feature. The fact that in some languages reference is made to voiced obstruents but not voiced sonorants follows from constraints that refer to [voice] and [obstruent]. An example of such a pattern is Rendaku voicing in Japanese, which is conditioned by the restriction of maximally one voiced obstruent per prosodic word (Itô et al. 1995; Itô & Mester 2003).

Tableau (194) shows an analysis of the Bade pattern. The faithful candidate (a) fatally violates alignment. Candidate (b) shows delinking of the first High tone, violating MAXLINK[h]. The winning candidate (c) has spreading to the first vowel, while the intervening consonant is only d-associated. This candidate violates alignment twice and DEPLINK[h] once. Candidate (d) has a skipped configuration. Although this candidate would violate fewer constraints than candidate (c), it is ruled out by the Strict Locality Condition (142). Candidate (e) has total spreading to the voiceless obstruent and a vowel. This candidate violates DEPLINK[h] once more than (c). As we have seen several times before, spreading to non-targets is never preferred and ruled by DEPLINK[f] regardless of where this constraint is ranked. Candidate (f) has total spreading and violates the high ranked feature co-occurrence constraint. Finally, candidate (g), which would win if evaluated, is ruled out by Gen because spreading never skips segments.<sup>5</sup>

---

<sup>4</sup>Prenasalized stops are also voiced. Durvasula (2009) argues that there are two kinds of prenasalized stops, one of which is voice based. If so, nasalization in Bade could be a manifestation of voicing.

<sup>5</sup>It remains to be seen whether the alternative analysis based on an alignment constraint that has moras or syllables as the targeted structures allows for skipping of non-moraic segments. This ultimately depends on whether tone is analyzed as a prosodic phenomenon (parallel to footing or stress), as a segmental feature, or both.



(194) ná tǎmbǎlú ‘I pushed’

|    | $\begin{array}{c} [h] \\ / n \text{ ə } t \text{ ə } m b \text{ ə } l \text{ ǔ } / \\ [h] \end{array}$                                        | *[h voi obs] | MAXLK[h] | * $\omega([h],v)$ | DEPLK[h] |
|----|-----------------------------------------------------------------------------------------------------------------------------------------------|--------------|----------|-------------------|----------|
| a. | $\begin{array}{c} [h] \\ n \text{ ə } t \text{ ə } m b \text{ ə } l \text{ ǔ } \\ [h] \end{array}$                                            |              |          | ***!              |          |
| b. | $\begin{array}{c} [h] \\ n \text{ ə } t \text{ ə } m b \text{ ə } l \text{ ǔ } \\ [h] \end{array}$                                            |              | *!       |                   |          |
| c. | $\begin{array}{c} [H] \\ h \\ h \text{ } h \\ n \text{ ə } t \text{ ə } m b \text{ ə } l \text{ ǔ } \\ [h] \end{array}$                       |              |          | **                | *        |
| d. | $\begin{array}{c} [H] \\ h \text{ } h \\ n \text{ ə } t \text{ ə } m b \text{ ə } l \text{ ǔ } \\ [h] \end{array}$                            | Ruled        | out by   | SLC               | (142)    |
| e. | $\begin{array}{c} [H] \\ h \text{ } H \\ h \text{ } h \text{ } h \\ n \text{ ə } t \text{ ə } m b \text{ ə } l \text{ ǔ } \\ [h] \end{array}$ |              |          | **                | **!      |
| f. | $\begin{array}{c} [H] \\ h \text{ } H \\ h \text{ } h \text{ } h \\ n \text{ ə } t \text{ ə } m b \text{ ə } l \text{ ǔ } \\ [h] \end{array}$ | *!           |          | *                 | **       |
| g. | $\begin{array}{c} [H] \\ h \text{ } H \\ h \text{ } h \text{ } h \\ n \text{ ə } t \text{ ə } m b \text{ ə } l \text{ ǔ } \\ [h] \end{array}$ | Ruled        | out by   | SLC               | (142)    |

We have now seen an account of blocking in Bade, which is attributed to a high ranked feature co-occurrence constraint. However, this approach is not sufficient to explain the difference between attested and unattested patterns of tone blocking. More specifically, while voiced obstruents frequently block spreading of High tone, plain obstruents do not. In fact, no known language shows blocking of High tone spreading by voiced obstruents but not by voiceless obstruents (Schuh 1978; Bradshaw 1997, 1999; Tang 2008). There are several existing solutions how to account for this gap. One option is to rely on the typology of feature co-occurrence constraints (Tang 2008; Lee 2008 for further discussion). This includes fixed ranking among the feature co-occurrence constraints (Walker 1998/2000, see section 6.6) or stringent constraints (de Lacy 2002, 2006, 2007). With respect to tone block-

ing, the fixed ranking approach would have to claim that the constraint \*[h voice obstruent] universally outranks \*[l voice obstruent]. This way voiced obstruents could never block low tone, but could block high tone. The stringent constraint approach, on the other hand, would claim that there are at least two constraints \*[h voice obstruent] and \*[tone voice obstruent]. Regardless of how the two constraints are ranked, low tone would never be blocked by a voiced obstruent. This approach also excludes the constraint \*[l voice obstruent]. An alternative solution would be a representational account. Bradshaw (1999), for example, proposed that there is a single feature [l/voice]. Simply put, this feature is realized as low tone on vowels, but as voicing on obstruents.

In this section, I discussed blocking by consonants in vowel harmony and tone spreading. In the current approach, blocking is enforced by feature co-occurrence constraints. An important claim of this approach is that blocking shows less regularity than transparency. That is, a single segment may be a blocker in some patterns, or may be exceptional in that it is not a blocker. In the following section, I look at blocking in nasal harmony and contrast it with transparency.

## 6.6 Nasal harmony

This section provides a cross-linguistic account of nasal harmony, with particular attention to blockers and transparent segments. The main point I am advancing is that the cross-linguistic typology of blocking is unlike the cross-linguistic typology of transparency. Consequently, two independent mechanisms are required to capture both phenomena. In section 6.6.1, I review the blocking patterns found in various languages and demonstrate their compatibility with the current approach based on feature co-occurrence constraints. In section 6.6.2, I move to transparency in nasal harmony. I account for the patterns by invoking two alignment constraints which differ in their targeted structures. Finally, section 6.6.3 presents a case study of nasal harmony in Mòbà which has blockers and transparent segments.

### 6.6.1 Blocking

Nasal harmony is likely one of the best understood assimilation patterns, both in terms of phonetics and phonology (Schourup 1973; Cohn 1990, 1993a; Walker 1998/2000, 2003; Piggott & van der Hulst 1997; Piggott 2000, 2003, *inter alia*). Most typically, nasal harmony affects a contiguous string of segments. Nasalization is terminated either by a domain edge or a blocking segment. As regards the blocking segments, they display a clear hierarchical pattern. In this section, I examine this hierarchical relationship between blockers, which is particularly relevant in the light of evidence from vowel harmony. Recall that in vowel harmony, blocking

by consonants is independent of blocking by other vowels. There are languages in which only some vowels block vowel harmony (e.g. Wolof). Conversely, there are languages in which only some consonants block vowel harmony (e.g. Finnish). Finally, some languages have blocking consonants and vowels (e.g. Turkish). Nasal harmony, on the other hand, shows a more restricted blocking pattern, in which some blockers imply others, but not necessarily vice versa.

In chapter 2, we have already seen several cases of nasal harmony: Applecross (5), Sundanese (12), and Epena Pedee (14). In (195), I present data that show the typology of blockers in progressive nasal harmony. In Sundanese (195-a), nasal harmony spreads from a nasal sonorant stop to a vowel, but is blocked by any consonant. In Johore Malay (195-b), nasality also spreads to glides, but all liquids and obstruents block spreading. In Epena Pedee (195-c), progressive nasalization is triggered by nasal vowels and sonorant stops, targets all vowels and sonorants, but is blocked by obstruents. Finally, in Applecross Gaelic (195-d) nasality spreads to all vowels and fricatives, but not to stops, which block further spreading.

(195) Blocking of nasal harmony

- a. Blocked by all consonants: Sundanese (Robins 1957:91,95)
- |               |                      |
|---------------|----------------------|
| <u>m</u> ãwur | ‘to spread’          |
| ŋãjak         | ‘to sift’            |
| <u>m</u> ãro  | ‘to halve’           |
| ŋũliat        | ‘to stretch (INTR.)’ |
| ŋũdag         | ‘to pursue’          |
| ŋãtur         | ‘to arrange’         |
- b. Blocked by all consonants except glides: Johore Malay (Onn 1980:45)
- |                   |                   |
|-------------------|-------------------|
| baŋõn             | ‘to rise’         |
| <u>m</u> ãjãŋ     | ‘to cause to cry’ |
| <u>m</u> ẽwãh     | ‘to be luxurious’ |
| <u>m</u> õratappi | ‘to cause to cry’ |
| <u>m</u> ãkan     | ‘to eat’          |
| <u>n</u> ãẽʔ      | ‘to ascend’       |
- c. Blocked by obstruents: Epena Pedee (Harms 1985:16; Harms 1994: 4–6)
- |                                    |                   |
|------------------------------------|-------------------|
| mĩmĩõjãã                           | ‘work a lot’      |
| wãĩ <sup>n</sup> t <sup>h</sup> ee | ‘go.FUT’          |
| nãwẽ                               | ‘mother’          |
| perõrã                             | ‘guagua (animal)’ |
| k <sup>h</sup> ĩ <sup>n</sup> siə  | ‘think’           |
| mẽ <sup>n</sup> dewe               | ‘blind snake’     |

d. Blocked by stops: Applecross Gaelic (Ternes 1973:134,135)

|                                                    |                   |
|----------------------------------------------------|-------------------|
| $\tilde{a}h\tilde{u}\tilde{c}$                     | ‘neck’            |
| $\tilde{f}\tilde{r}\tilde{i}\tilde{a}\tilde{v}$    | ‘root.PL.’        |
| $k^h\tilde{o}\tilde{v}\tilde{i}\tilde{a}\tilde{t}$ | ‘how much/many?’  |
| $st\tilde{r}\tilde{i}\tilde{a}\tilde{i}\tilde{y}$  | ‘to be luxurious’ |
| $^k\tilde{h}\tilde{u}\tilde{s}paxk$                | ‘wasp’            |
| $^t\tilde{h}\tilde{a}\tilde{h}\tilde{u}\tilde{s}k$ | ‘fool’            |

The four languages show an implicational relationship between blockers. In any given language, if a glide blocks nasal harmony, then liquids do too (but not the reverse). Similarly, if a sonorant blocks nasal harmony, so do obstruents (but not the reverse). Table 6.2 provides a summary.

| VOWELS | GLIDES | LIQUIDS | FRICATIVES | OBS. STOPS | EXAMPLE LANGUAGE    |
|--------|--------|---------|------------|------------|---------------------|
| ✓      | ✓      | ✓       | ✓          | ✓          | German (no harmony) |
|        | ✓      | ✓       | ✓          | ✓          | Sundanese           |
|        |        | ✓       | ✓          | ✓          | Johore Malay        |
|        |        |         | ✓          | ✓          | Epena Pedee         |
|        |        |         |            | ✓          | Applecross Gaelic   |

Table 6.2: Blockers in nasal harmony

One way to describe this typology is to say that nasality prefers spreading to some segments more than others. If so, nasality prefers spreading vowels to glides, glides to liquids, liquids to fricatives, and fricatives to stops, as schematized in (196). As noted by Walker (1998/2000), this hierarchy looks very similar to the sonority hierarchy (Hooper 1972, 1976; Steriade 1982; Zec 1988/1994, 1995; Prince & Smolensky 1993/2004; Kenstowicz 1997; Morén 1999/2001; de Lacy 2004, 2006, 2007), which suggests that nasalization and sonority correlate to some degree. However, there are also some finer-grained differences between the two. First, nasal sonorant stops are the most compatible with nasalization, but not the most sonorous segments. Second, low vowels have the greatest sonority, whereas high vowels prefer nasalization over low vowels at least in some languages. Third, glottals are the least sonorous, but they do not block nasalization (see Cohn 1990 for acoustic measurements and Cohn 1993a; Walker 1998/2000; Walker & Pullum 1999 for further discussion).

(196) Nasalization hierarchy (after Schourup 1973; Pulleyblank 1989; Cohn 1993b; Walker 1995, 1998/2000)

Most compatible with [nasal]                      Least compatible with [nasal]  
 vowels > glides > liquids > fricatives > obstruent stops

Recall that segmental blocking can only be attributed to feature co-occurrence constraints. No other constraint in the current approach can enforce blocking by segments. This suggests that the difference in segments' preference or aversion to [nasal] can only be attributed to several different feature co-occurrence constraints. Walker (1998/2000) proposes the universal fixed ranking in (197). While it would be possible to formalize these constraints in terms of sonority, I will remain agnostic about such an approach. As pointed out above, the sonority and nasalization hierarchies are only partially overlapping. I will introduce feature co-occurrence constraints consistent with the approach developed in this thesis in section 6.6.3.

- (197) Nasalized segment constraint hierarchy (Walker 1998/2000:36)
- \*NASOBSSTOP  $\equiv$  \*[+nas -cont -son]  $\gg$
  - \*NASFRICATIVE  $\equiv$  \*[+nas +cont -son]  $\gg$
  - \*NASLIQUID  $\equiv$  \*[+nas +approx +cons]  $\gg$
  - \*NASGLIDE  $\equiv$  \*[+nas +approx -cons -syll]  $\gg$
  - \*NASVOWEL  $\equiv$  \*[+nas +approx -cons +syll]  $\gg$
  - \*NASSONSTOP  $\equiv$  \*[+nas +son -cont]

The fixed ranking in (197) has a simple effect: regardless of how other constraints are ranked, no output is possible such that, for example, glides block spreading but obstruents do not. In the present context, the other relevant constraints are the faithfulness constraint DEPLINK[nasal] and alignment constraints. One of these alignment constraints requires that no root node is f-preceded by [nasal] within a prosodic word, as in (198).

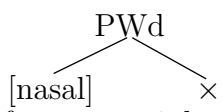
- (198) \* $\omega$ ([nasal],  $\times$ )
- a. \* $\langle$ PWd, [nasal],  $\times$  $\rangle$  / 
- b. Assign a violation mark for every triplet  $\langle$ PWd, [nasal],  $\times$  $\rangle$ , iff  
*PWd* is associated with [nasal] and  $\times$   
 and  
 [nasal]  $\triangleleft$   $\times$ .

I now demonstrate that no ranking of the alignment constraint in (198) and the faithfulness constraint DEPLINK[nasal] with respect to the feature co-occurrence constraint hierarchy in (197) can produce unattested patterns. One of such unattested patterns is a hypothetical language in which fricatives become nasalized, but glides block nasalization. The easiest way to make this explicit is by using a comparative tableau and make reference to Recursive Constraint Demotion (henceforth, RCD; Tesar 1995; Tesar & Smolensky 1998, 2000). RCD is an algorithm that is guaranteed to produce a ranking that satisfies a consistent set of ranking

arguments. The algorithm relies on elimination of those constraints that prefer winners first. In (199), I leave out the detailed representations, and assume a single instance of [nasal]. The intended winner spreads nasality to the fricative, while the glide blocks spreading. RCD posits that the highest constraint of all of these is the one that prefers the winner over all other candidates. The only such constraint is the feature co-occurrence constraint \*NASGLIDE. However, according to the universal ranking in (197), \*NASFRICATIVE should outrank this constraint. We can conclude that if \*NASFRICATIVE outranks \*NASGLIDE, the candidate \*[nãžãja] cannot win, and this fact is independent of alignment and faithfulness constraints. This matches empirical observations about blockers of nasal harmony.

(199) /nazaja/ → [nãžãja] can surface only with a dominant \*NASGLIDE

| /nazaja/    | *NASFRIC | *NASGLIDE      | *NASVOWEL      | *ω([nas], ×)   | DEPLK[nas]     |
|-------------|----------|----------------|----------------|----------------|----------------|
| ☞ nãžãja    | 1        |                | 2              | 2              | 3              |
| a. ~ nazaja | L        |                | L              | <sub>5</sub> W | L              |
| b. ~ nãzaja | L        |                | <sub>1</sub> L | <sub>4</sub> W | <sub>1</sub> L |
| c. ~ nãžãjã | 1        | <sub>1</sub> W | <sub>3</sub> W | L              | <sub>5</sub> W |

As we have seen, blocking in nasal harmony displays hierarchical properties. One way of capturing this observation is by a fixed ranking of co-occurrence constraints. I should add that while the generalization concerning blockers in nasal harmony seems to hold in the vast majority of reported cases, there are a few exceptions. One of these is the Mòbà dialect of Yoruba (Ajíbóyè & Pulleyblank 2008), in which nasality spreads to sonorants and high vowels, but not to non-high vowels. This pattern is further discussed in section 6.6.3.<sup>6</sup>

We have now seen that nasal harmony differs from other types of assimilation. First, as we have just seen, nasality exhibits implicational characteristics in blocking. Other patterns do not seem to exhibit such patterns. For example, vowel harmony in some languages is blocked by a subset of vowels, but not by consonants (section 6.4). In others, consonants block vowel harmony, but not vowels (section 6.5.1). This suggests that vowel harmony does not exhibit an implicational relationship between blockers. Second, most other features usually do not spread to all segments. However, such a generalization is only partial. We have already seen one example where a single feature affects all root nodes, SPalestinian (sections 3.2.1 and 6.3). This suggests that such patterns are rare, but attested. Since there

<sup>6</sup>Other examples include blocking by schwa but not other vowels in Applecross (Ternes 1973), blocking by [r] but not [ɾ] in Epena Pedee (Harms 1985, 1994) and blocking by [ɬ] but not [r] in Urhobo (Kelly 1969).

are not many languages with emphasis spread, a full typology of blockers is hard to establish.<sup>7</sup> In other words, blockers may exhibit an implicational relationship with other features, but these patterns are not frequent enough to allow for such a generalization. The third and final point concerns transparent segments. Nasal harmony typically affects a contiguous string of segments, whereas assimilation involving other features does not. I further discuss this point in the following section.

### 6.6.2 Transparency

As we have seen above, blocking in nasal harmony is a rather well understood phenomenon. The status of transparency, on the other hand, is much less clear. In this section, I propose an account of transparency based on alignment constraints. I present evidence for two types of alignment constraints which are in a stringency relation. Only one of the two constraints results in transparent segments.

So far we have looked at nasal harmony patterns that involve contiguous strings of segments. For example, Applecross (195-d) shows nasal harmony which targets all segments except stops (and schwa). Nasality in Applecross cannot skip a segment. If a segment resists nasalization, it will block spreading entirely. Given that a vast majority of nasal harmony patterns involve only contiguous strings of targets, one would be inclined to say that nasal harmony differs from other assimilation processes in that it does not allow transparent segments. An example of this type of reasoning is the work of Walker (1999, 1998/2000). She looks at voiceless stops in Guaraní, which do not block nasal harmony, but which are not themselves nasal. Walker measures several acoustic variables (duration, formants etc.), and concludes that obstruents in nasal environments do differ from stops in non-nasal environments, but not in terms of nasality. She suggests that it might be the case that stops undergo nasalization, but are subsequently denasalized (because of the articulatory incompatibility of stops with nasalization).

Similar phonetic effects are found in other cases of transparency. For example, Boyce (1990) compares lip rounding by English and Turkish speakers. She finds that Turkish speakers display lip rounding of consonants flanked by round vowels, while English speakers do not. In the context of this thesis, these data actually support an alternative analysis that allows for phonetic effects on transparent segments. This includes nasal harmony and is consistent with the lack of convincing phonetic data that could distinguish transparent from targeted nasal voiceless stops. However, voiceless stops involve a complete articulatory closure, which is not compatible with nasal voicing. Hence, a phonological analysis cannot

---

<sup>7</sup>Davis (1995) analyzes two dialects of Palestinian Arabic. In the southern dialect front segments block rightward emphasis spread, whereas the northern dialect high segments do.

rely on acoustic or articulatory data concerning nasalization of voiceless stops. The only evidence available is phonological behavior, which is whether they terminate nasalization or not. When stops do not stop spreading, they are transparent.

Guaraní (Gregores & Suarez 1967; Walker 1999) is not the only language with transparent segments in nasal harmony. Several others also contain transparent obstruents, including Barasano (Gomez-Imbert 1997), Tuyuca (Barnes 1996) and Mòbà (Ajíbóyè & Pulleyblank 2008). To illustrate, I briefly describe the last pattern. The Mòbà dialect of Yoruba exhibits nasal harmony that targets sonorants (including vowels). This generalization is supported by static patterns and alternations (200). When a word consists exclusively of a vowel preceded by a sonorant, they are always both oral or nasal, as shown in (200-a). Words of the type \*[rũ] or \*[řu] are not found. The static patterns are supported by alternations in (200-b): a prefix that precedes a nasal root is also nasal.

(200) Mòbà nasal harmony (Ajíbóyè & Pulleyblank 2008)<sup>8</sup>

a. Distributions

|    |         |    |         |
|----|---------|----|---------|
| ri | ‘drown’ | řĩ | ‘walk’  |
| ru | ‘carry’ | řũ | ‘smell’ |

b. Alternations

| VERB | NOUN         |        | VERB | NOUN         |          |
|------|--------------|--------|------|--------------|----------|
| ʃɛ   | <u>ɹ</u> -ʃɛ | ‘eat’  | řĩ   | <u>ɹ</u> -řĩ | ‘walk’   |
| fɛ   | <u>ɹ</u> -fɛ | ‘like’ | ĩĩ   | <u>ɹ</u> -ĩĩ | ‘praise’ |

Obstruents show a different pattern: they can occur in oral and nasal roots (201). In other words, they do not interfere with nasal harmony and are transparent to the process.

(201) Transparent obstruents

|     |          |     |           |
|-----|----------|-----|-----------|
| uʃɛ | ‘bait’   | ĩdũ | ‘bed bug’ |
| ufe | ‘love’   | ũgũ | ‘corner’  |
| uko | ‘basket’ | ĩsĩ | ‘worship’ |

We have now seen a pattern in which vowels and sonorants are targets of nasal harmony, while obstruents are transparent. Table 6.3 shows the cross-linguistic typology of transparent segments in nasal harmony. Two patterns are attested. Only one pattern involves transparent segments, and we can see that only obstruents can be transparent.

An account of the transparency typology in nasal harmony cannot be based purely on feature co-occurrence constraints. This is because a feature co-occurrence constraint enforces blocking rather than transparency, as demonstrated in sections

---

<sup>8</sup>Tones are omitted.



| VOWELS | GLIDES | LIQUIDS | FRICATIVES | OBS. STOPS | EXAMPLE LANGUAGE            |
|--------|--------|---------|------------|------------|-----------------------------|
|        |        |         | ✓          | ✓          | Guaraní, Mòbà<br>Applecross |

Table 6.3: Transparent segments in nasal harmony

6.2–6.4. Furthermore, the cross-linguistic blocking typology in nasal harmony (Table 6.2) looks very different from the cross-linguistic transparency typology (Table 6.3). Consequently, if feature co-occurrence constraints are used to explain the unattested blocking patterns, they cannot be used for the gaps in transparency. Walker’s (1998/2000, 2003) account of these facts is that transparent segments present a case of counter-bleeding opacity (Kiparsky 1971, 1973). According to her approach, nasality first spreads to all segments after which nasality gets delinked from obstruents. In this sense, all transparent segments are opaque. In response to this, Walker models opacity by making use of Sympathy Theory (McCarthy 1999).

In the current approach, transparency is not determined by feature co-occurrence constraints, but it is instead decided by alignment constraints in combination with low ranked faithfulness. In most cases of nasal harmony, the alignment constraint targets all root nodes, and hence none are skipped. However, in the cases discussed in this section, only sonorants (including vowels) are targeted, while obstruents remain transparent. These transparent obstruents are not targeted by the alignment constraint. Hence, the alignment constraint contains [sonorant] as the targeted structure rather than a root node. An example of such a constraint that contains a prosodic word as the domain and enforces rightward spreading of [nasal] to all sonorants is in (202). In this context, [sonorant] is the feature common to all sonorants and vowels.

(202) \* $\omega$ ([nasal], sonorant)

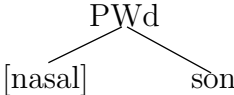
- a. \* $\langle$ PWd, [nasal], [son] $\rangle$  / 
- b. Assign a violation mark for every triplet  $\langle$ PWd, [nasal], [son] $\rangle$ , iff  
*PWd* is associated with [nasal] and a *son*-node of [sonorant]  
 and  
 [nasal]  $\triangleleft$  *son*.

As we have just seen, the alignment constraint in (202) is grounded in that sonorants make better targets than obstruents. In a larger context, nasality prefers sonorants over obstruents even in patterns other than assimilation (cf. Anderson 1976a; Rice 1992, 1993; Durvasula 2009). This allows for a direct parallel between

nasal harmony and other types of assimilation. Recall that consonants are usually transparent to vowel harmony and this is attributed to alignment constraints. In RTR harmony, for example, consonants may be skipped if the targeted structure of the alignment constraint is a vowel. By extension, skipping of obstruents in nasal harmony is attributed to alignment constraints that have [sonorant] as the targeted structure.

The current approach to transparency is actually even more restrictive. In section 3.2, I attributed the locality patterns in assimilation to the typology of alignment constraints. More specifically, only some targeted structures are allowed with a particular feature. When the spreading feature is [nasal], only some targeted structures are allowed in alignment constraints. In particular, [obstruent] is an impossible targeted structure, while [sonorant] (202) and a root node (198) are. In the languages without transparent segments, the constraint with a root node as the domain is entirely sufficient. In contrast, languages with transparent obstruents require the constraint containing [sonorant] as the targeted structure. This matches the cross-linguistic facts. While there are languages with transparent obstruents (such as Barasano, Tuyuca, and Mòbà discussed above), there are no languages with transparent sonorants.<sup>9</sup> The two alignment constraints cannot generate a language with nasal harmony that targets obstruents but not sonorants. This approach also excludes nasal vowel harmony, an unattested pattern (van der Hulst & van de Weijer 1995:525).

In (203), I show that alignment constraints cannot create a language that skips sonorants. I include the two alignment constraints from (198) and (202) and the faithfulness constraint *DEPLINK*[nasal]. Feature co-occurrence constraints are not shown because they never prefer transparent segments over targets, as already demonstrated for [rtr] spreading in (191). Eight candidates are shown. Candidate (a) is faithful and wins if *DEPLINK*[nasal] is ranked above the other two constraints. Candidates (b–f) have at least one transparent sonorant. All are harmonically bounded. The remaining two candidates (g–h) do contain transparent sonorants and can win under some ranking.

---

<sup>9</sup>In section 8.5.4, we will see that the attested cases of transparent vowels—as in Yaka (9)—are attributed to other markedness constraints.

(203) Factorial typology in nasal harmony (without feature co-occurrence constraints)

| $\begin{array}{c} [n] \\   \\ / \times \text{ a r t } \times / \end{array}$                                                                                                                                                                                                                  | * $\omega$ ([nas],son) | * $\omega$ ([nas], $\times$ ) | DEPLINK[nas] |
|----------------------------------------------------------------------------------------------------------------------------------------------------------------------------------------------------------------------------------------------------------------------------------------------|------------------------|-------------------------------|--------------|
| a. $\begin{array}{c} [n] \\   \\ \text{ n a r t } \times \end{array}$                                                                                                                                                                                                                        | a r                    | a r t $\times$                |              |
| b. $\begin{array}{c} [N] \\   \quad \diagdown \\ \text{ n } \quad \text{ N} \\   \quad   \quad   \quad   \\ \text{ n } \quad \text{ n } \quad \text{ n } \quad \text{ n} \\   \quad   \quad   \quad   \\ \times \quad \text{ a } \quad \text{ r } \quad \text{ t } \quad \times \end{array}$ | a r                    | a r                           | **           |
| c. $\begin{array}{c} [N] \\   \quad \diagdown \\ \text{ n } \quad \text{ N} \\   \quad   \quad   \quad   \\ \text{ n } \quad \text{ n } \quad \text{ n } \quad \text{ n} \\   \quad   \quad   \quad   \\ \times \quad \text{ a } \quad \text{ r } \quad \text{ t } \quad \times \end{array}$ | r                      | r t                           | **           |
| d. $\begin{array}{c} [N] \\   \quad \diagdown \\ \text{ n } \quad \text{ N} \\   \quad   \quad   \quad   \\ \text{ n } \quad \text{ n } \quad \text{ n } \quad \text{ n} \\   \quad   \quad   \quad   \\ \times \quad \text{ a } \quad \text{ r } \quad \text{ t } \quad \times \end{array}$ | a                      | a t                           | **           |
| e. $\begin{array}{c} [N] \\   \quad \diagdown \\ \text{ n } \quad \text{ N} \\   \quad   \quad   \quad   \\ \text{ n } \quad \text{ n } \quad \text{ n } \quad \text{ n} \\   \quad   \quad   \quad   \\ \times \quad \text{ a } \quad \text{ r } \quad \text{ t } \quad \times \end{array}$ | r                      | r                             | ***          |
| f. $\begin{array}{c} [N] \\   \quad \diagdown \\ \text{ n } \quad \text{ N} \\   \quad   \quad   \quad   \\ \text{ n } \quad \text{ n } \quad \text{ n } \quad \text{ n} \\   \quad   \quad   \quad   \\ \times \quad \text{ a } \quad \text{ r } \quad \text{ t } \quad \times \end{array}$ | a                      | a                             | ***          |
| g. $\begin{array}{c} [N] \\   \quad \diagdown \\ \text{ n } \quad \text{ N} \\   \quad   \quad   \quad   \\ \text{ n } \quad \text{ n } \quad \text{ n } \quad \text{ n} \\   \quad   \quad   \quad   \\ \times \quad \text{ a } \quad \text{ r } \quad \text{ t } \quad \times \end{array}$ |                        | t                             | ***          |
| h. $\begin{array}{c} [N] \\   \quad \diagdown \\ \text{ n } \quad \text{ N} \\   \quad   \quad   \quad   \\ \text{ n } \quad \text{ n } \quad \text{ n } \quad \text{ n} \\   \quad   \quad   \quad   \\ \times \quad \text{ a } \quad \text{ r } \quad \text{ t } \quad \times \end{array}$ |                        |                               | ****         |

Candidate (g) has total spreading and is predicted by the current approach. However, to the best of my knowledge, no documented language shows spreading to voiceless stops. Walker (1998/2000) accounts for this by ranking the feature co-occurrence constraint against voiceless stops above the constraint that prefers spreading. The current approach offers no further insight into this matter.

This concludes the general overview of nasal harmony. Nasal harmony shows transparent obstruents, but not transparent sonorants. This is attributed to a restriction on alignment constraints. If an alignment constraint contains [nasal] as the spreading feature, it cannot have [obstruent] as the targeted structure. There are no known cases in which sonorants would be transparent to nasal harmony, and the current approach cannot generate them. Blocking, on the other hand, is attributed to feature co-occurrence constraints. Most languages show an implicational relationship between blockers, which can be accounted for by a universally fixed ranking among these constraints or stringent relationship among them. In the following section, I will show a language that is exceptional in terms of blocking. This is attributed to a high ranked feature co-occurrence constraint.

### 6.6.3 Mòbà

In this section, I give an analysis of the nasal harmony pattern in Mòbà. This language has regressive nasal harmony and shows both types of non-targets: obstruents are transparent, while non-high vowels are blockers. The purpose of this section is to show how these different types of segments can be easily handled within the current approach. In particular, transparency is determined by alignment constraints, while blocking is enforced by feature co-occurrence constraints.

#### Data

The Mòbà dialect of Yoruba (Ajíbóyè & Pulleyblank 2008) has nasal harmony that targets all sonorants. The data has already been introduced in (200) and (201), but I give more examples below. When a word consists exclusively of a vowel preceded by a sonorant, they are always both oral or nasal, as shown in (204-a). Words of the type \*[rũ] or \*[ĩũ] are not found. The static patterns are supported by alternations in (204-b): a prefix that precedes a nasal root is also nasal.

(204) Mòbà nasal harmony (Ajíbóyè & Pulleyblank 2008)

a. Distributions

|    |         |    |          |
|----|---------|----|----------|
| ri | ‘drown’ | ĩĩ | ‘walk’   |
| ru | ‘carry’ | ĩũ | ‘smell’  |
| ya | ‘draw’  | ỹã | ‘choose’ |
| ra | ‘buy’   | ĩã | ‘spread’ |

b. Alternations

| VERB | NOUN         |        | VERB | NOUN         |           |
|------|--------------|--------|------|--------------|-----------|
| ʃɛ   | <u>u</u> -ʃɛ | ‘eat’  | ĩĩ   | <u>ũ</u> -ĩĩ | ‘walk’    |
| fɛ   | <u>u</u> -fɛ | ‘like’ | ỹĩ   | <u>ũ</u> -ỹĩ | ‘praise’  |
| ko   | <u>u</u> -ko | ‘pack’ | nĩ   | <u>ũ</u> -nĩ | ‘have’    |
|      |              |        | ã    | <u>ũ</u> -ã  | ‘measure’ |

Obstruents, on the other hand, can occur in oral and nasal roots (205). In other words, they do not interfere with nasal harmony and are transparent to the process.

(205) Transparent obstruents

|     |          |        |                       |
|-----|----------|--------|-----------------------|
| uʃɛ | ‘bait’   | ĩdũ    | ‘bed bug’             |
| ufe | ‘love’   | ũgũ    | ‘corner’              |
| uko | ‘basket’ | ĩsĩ    | ‘worship’             |
|     |          | ĩfũ    | ‘intestine’           |
|     |          | ũkpĩ   | ‘type of insect’      |
|     |          | ĩsũgbĩ | ‘traditional singers’ |

Nasalization applies leftwards, not rightwards. In (206) we see words that have a nasal vowel in the second syllable. The first vowel is also nasal, while the last is not. There are no words with only the non-initial vowel nasalized—\*[itĩsĩ] or \*[itĩsi], while there are words with only the first two vowels nasalized. This fact can be analyzed only if the second vowel is underlyingly nasal, and nasalization applies leftwards. The nominalizing prefix /u-/ is not underlyingly nasal, as shown in (204-b).

(206) Leftward, not rightward, nasalization

|       |                              |
|-------|------------------------------|
| ũnĩra | ‘difficulty’                 |
| ũmũra | ‘preparedness’               |
| ũmãsi | ‘having knowledge of an act’ |
| ũmãɛ  | ‘intestine’                  |

The remaining class of segments are non-high vowels, which always block harmony, as in (207). Blocking by vowels is surprising, given the fact that sonorants are

targets. Thus, Mòbà is unlike most other reported languages in which spreading to sonorant consonants implies spreading to all vowels.<sup>10</sup>

- (207) Non-high vowels are blockers
- |                |                      |
|----------------|----------------------|
| ur <u>o</u> ĩ  | ‘news’               |
| uk <u>o</u> ĩũ | ‘thread for plating’ |
| ur <u>ɔ</u> ĩũ | ‘peace of mind’      |
| ir <u>e</u> gũ | ‘reproaching’        |
| us <u>e</u> gũ | ‘act of medication’  |
| ul <u>a</u> ĩũ | ‘comb’               |
| it <u>a</u> kũ | ‘root’               |
| us <u>a</u> sũ | ‘kind of pot’        |

To sum up, Mòbà has leftward vowel harmony, triggered by an underlying segment. Obstruents are transparent to this process, while non-high vowels act as blockers. In the next section, I show that the difference between the two types of segments stems from different constraints that refer to them.

### Analysis

Central to the analysis of any assimilation process are two constraints. The markedness constraint driving assimilation and the faithfulness constraint inhibiting spreading. In the context of this thesis, the first constraint is an alignment constraint, while the second is a faithfulness constraint against adding association lines. This is an analysis of Mòbà *nasal* harmony, and the relevant faithfulness constraint is DEPLINK[nasal].

The alignment constraint has [nasal] as the spreading feature and a prosodic word as the domain. The remaining category is the targeted structure. In Mòbà, obstruents are transparent to nasal harmony. Recall that transparency and the targeted structures of alignment constraints are related, as stated in (172). When a single alignment constraint is ranked above DEPLINK[f], the set of transparent segments and the set of segments containing the targeted structure are complements of one another. In Mòbà, there is a single active alignment constraint ranked above faithfulness. The targeted structure of this alignment constraint is a complement of all obstruents. Hence, the targeted structure is [sonorant]. Harmony is regressive, which means that the spreading feature [nasal] must not f-precede the targeted structure [sonorant]. The relevant alignment constraint is

<sup>10</sup>There is also a difference between mid and low vowels in that the low vowel [a] triggers spreading, while the mid vowels cannot surface nasalized, even if underlying. This suggests that MAX[nasal] is ranked below the feature co-occurrence constraint against nasal mid vowels \*[nasal open closed], but above the constraint against nasal low vowel \*[nasal low]. Thus, only underlying /ã/'s are allowed to surface.

\* $\omega(\text{sonorant},[\text{nasal}])$ , which is very similar to the constraint in (202), but instead the f-precedence relations are reversed. The alignment constraint outranks the feature co-occurrence constraint against nasal obstruents \*[nasal obstruent]. Here, I also use \*[nasal sonorant] as a shorthand for a number of constraints against nasal glides, laterals and vowels. The alignment constraint \* $\omega(\times,[\text{nasal}])$  is outranked by DEPLINK[nasal].

In (208), I show the ranking for an input that contains vowels that are all high. I analyze this form as having an underlying nasal vowel. The faithful candidate (a) fatally violates the dominant alignment constraint, as does candidate (b) with spreading only to the obstruent. Candidate (c) has total spreading, but violates DEPLINK[nasal] twice, as opposed to the winning candidate (d) with a transparent obstruent, which violates it only once. Given these constraints, candidate (b) is harmonically bounded. This is a good prediction, because nasalization of obstruents generally implies nasalization of vowels (but not vice versa).

(208) ifũ ‘intestine’

|    | $\begin{array}{c} [n] \\ / i f \underset{\downarrow}{\underset{\downarrow}{u}} / \end{array}$                                                                                             | * $\omega(\text{son},[\text{nas}])$ | DEPLK[nas] | *[nas obs] | *[nas son] | * $\omega(\times,[\text{nas}])$ |
|----|-------------------------------------------------------------------------------------------------------------------------------------------------------------------------------------------|-------------------------------------|------------|------------|------------|---------------------------------|
| a. | $\begin{array}{c} [n] \\ i f \underset{\downarrow}{\underset{\downarrow}{u}} \end{array}$                                                                                                 | i!                                  |            |            | ũ          | i f                             |
| b. | $\begin{array}{c} [N] \\ \swarrow \quad \searrow \\ n \quad n \\ \swarrow \quad \searrow \\ i f \underset{\downarrow}{\underset{\downarrow}{u}} \end{array}$                              | i!                                  | *          | f̃         | ũ          | i                               |
| c. | $\begin{array}{c} [N] \\ \swarrow \quad \searrow \\ N \quad n \\ \swarrow \quad \searrow \\ n \quad n \quad n \\ \swarrow \quad \searrow \quad \searrow \\ i \quad f \quad u \end{array}$ |                                     | **!        | f̃         | ĩ ũ        |                                 |
| d. | $\begin{array}{c} [N] \\ \swarrow \quad \searrow \\ n \quad n \\ \swarrow \quad \searrow \\ i f \underset{\downarrow}{\underset{\downarrow}{u}} \end{array}$                              |                                     | *          | f          | ĩ ũ        | f                               |

I now move to blocking. Only non-high vowels block nasal harmony in Mòbà. No other segments—including all consonants—exhibit blocking. Blocking is enforced by feature co-occurrence constraints. Recall Walker’s (1998/2000) strict ranking of feature co-occurrence constraints in (197). In her model, constraints against nasal obstruents must be ranked above constraints against nasal vowels. However, in Mòbà this ranking cannot be maintained. This is because non-high vowels are blockers, while consonants are not. This suggests that Walker’s strict hierarchy needs to be relaxed. In particular, the feature co-occurrence constraint against nasal non-high vowels needs to be ranked above constraints against nasal

consonants. The feature common to non-high vowels is [open], first introduced in section 3.2.3. This means that the relevant feature co-occurrence constraint is \*[nasal open], and this constraint outranks the alignment constraint \* $\omega(\text{son},[\text{nas}])$ . These two constraints are enough to choose among the candidates in tableau (209). The faithful candidate (a) violates the alignment constraint once more than the winning candidate (b), which has spreading to all targets up to the blocking open vowel. Candidates (c) and (d) contain an open vowel linked to [nasal], which incurs a violation of the feature co-occurrence constraint. Candidate (d) is harmonically bounded. This is a desirable prediction, since neither Mòbà nor any other language have transparent sonorants enforced by alignment.

(209) uroĩĩ ‘news’

| $\begin{array}{c} \text{[n]} \\ \downarrow \\ / \text{ u r } \underset{[\text{o}]}{\text{o}} \text{ j } \underset{[\text{i}]}{\text{i}} / \end{array}$                                                                                                                                                                                                                              | *[n open] | * $\omega(\text{son},[\text{n}])$ | DEPLK[n] | *[n son]  | * $\omega(\times,[\text{n}])$ |
|-------------------------------------------------------------------------------------------------------------------------------------------------------------------------------------------------------------------------------------------------------------------------------------------------------------------------------------------------------------------------------------|-----------|-----------------------------------|----------|-----------|-------------------------------|
| a. $\begin{array}{c} \text{[n]} \\ \downarrow \\ \text{u r } \underset{[\text{o}]}{\text{o}} \text{ j } \underset{[\text{i}]}{\text{i}} \end{array}$                                                                                                                                                                                                                                |           | u r o j!                          |          | ĩ         | u r o j                       |
| b. $\begin{array}{c} \text{[N]} \\ \swarrow \searrow \\ \text{u r } \underset{[\text{o}]}{\text{o}} \underset{[\text{j}]}{\text{j}} \underset{[\text{i}]}{\text{i}} \end{array}$                                                                                                                                                                                                    |           | u r o                             | *        | ĩ j       | u r o                         |
| c. $\begin{array}{c} \text{[N]} \\ \swarrow \searrow \\ \text{u } \text{r} \text{ } \text{o} \text{ } \text{j} \text{ } \text{i} \\ \swarrow \searrow \swarrow \searrow \\ \text{u } \text{r} \text{ } \text{o} \text{ } \text{j} \text{ } \text{i} \\ \swarrow \searrow \swarrow \searrow \\ \text{u } \text{r} \text{ } \text{o} \text{ } \text{j} \text{ } \text{i} \end{array}$ | õ!        |                                   | ****     | ũ ã õ ã ã |                               |
| d. $\begin{array}{c} \text{[N]} \\ \swarrow \searrow \\ \text{u } \text{r} \text{ } \text{o} \text{ } \text{j} \text{ } \text{i} \\ \swarrow \searrow \swarrow \searrow \\ \text{u } \text{r} \text{ } \text{o} \text{ } \text{j} \text{ } \text{i} \\ \swarrow \searrow \swarrow \searrow \\ \text{u } \text{r} \text{ } \text{o} \text{ } \text{j} \text{ } \text{i} \end{array}$ | o!        | o                                 | ***      | ũ ã o ã ã | o                             |

Ajíbóyè & Pulleyblank (2008) propose an alternative analysis of the Mòbà pattern, which is based on multiple feature co-occurrence constraints. Since feature co-occurrence constraints can be ranked one way or the other, this alternative predicts many unattested patterns, including vowel nasal harmony. The current



approach is much more restrictive in that only obstruents (but not sonorants) can be transparent.

This concludes the account of nasal harmony. I have shown that the current approach allows for a different treatment of transparency and blocking. On the one hand, transparency is directly related to alignment constraints. Cross-linguistically, sonorants are generally never transparent to nasal harmony. This fact is attributed to an alignment constraint that has [sonorant] as the targeted structure, which resembles the patterns found in RTR spreading. On the other hand, blocking is attributed to feature co-occurrence constraints. Existing approaches can capture the apparent implicational patterns in blocking by invoking strict ranking among feature co-occurrence constraints. I focus on the Mòbà data that contradict the majority pattern. These data provide evidence in favor of the current approach, which treats blocking differently from transparency. Blocking is attributed to feature co-occurrence constraints. A high ranked feature co-occurrence constraint may add an additional segment to the set of blockers. Transparency, in contrast, is attributed to alignment constraints. Even if they are ranked differently, no single segment can be added to the set of transparent segments.

## 6.7 Summary

The empirical argument of this chapter is that blocking works in a fundamentally different way compared to transparency. Classic Autosegmental Phonology obscures this fact and treats both phenomena the same: blockers and transparent segments are both not associated with the spreading feature. Similarly, classic OT treatments use feature co-occurrence constraints that are satisfied by transparent segments and blockers. The theoretical contribution of this chapter is an account of blocking *independent* of the account of transparency (developed in chapters 2, 3, and 5).

I first show that none of the previously used constraints can account for segmental blocking. This is because blockers are not associated with the spreading feature, which is a standard assumption. I then use a well established family of constraints that can. Feature co-occurrence constraints containing the spreading feature are never violated by a blocker, since it is not associated with that feature.

Next, I focus on [rtr] spreading and the fact that in some languages front segments block spreading, whereas in others high vowels do. Crucially, [rtr] harmony in Yoruba shows that high vowel blockers do not imply consonant blockers. This is notably different from transparency where it is always the case that transparent high vowels imply transparent consonants. We can conclude that the account of transparency cannot be based on the same constraints than blocking.

The contrast between blockers and transparent segments is further illustrated by consonant blocking in vowel harmony in tone spreading. What we have seen in these two cases is that a subset of consonants can act as blockers, and that some vowels may remain transparent. This difference between blocking and transparency is mirrored by the representations and constraints that refer to them. Specifically, no constraint prefers transparent segments. They surface solely because an alignment constraint prefers a target that is not strictly adjacent to a trigger. Blocking, on the other hand, is enforced by feature co-occurrence constraints, which may be ranked independently of alignment and faithfulness constraints.

The fact that transparency cannot be attributed to feature co-occurrence constraint has one important consequence, which sets the current model apart from the standard analyses. It is a fairly standard assumption that in some cases of vowel harmony transparency is related to the gaps in the segmental inventory. For example, Finnish backness harmony is said to have transparent {i, e} because the Finnish vowel inventory lacks the corresponding back unrounded vowels. In section 5.5.2, I have shown that no such assumption is required: when the alignment constraints have [round] and [low] as the targeted structure, the set of segments not containing those two features will be transparent. The non-low front unrounded vowels {i, e} are the only such segments. In short, transparency does not necessitate feature co-occurrence constraints.

The final part of this chapter is a cross-linguistic study of transparency and blocking in nasal harmony. In nasal harmony, only obstruents, but not sonorants, can be transparent. This observation is attributed to the fact that an alignment constraint preferring nasalization contains only root nodes and sonorants as targeted structures. Regardless of how these two types of alignment constraints are ranked with respect to one another, a pattern with nasal harmony from one obstruent to another across a sonorant can never be optimal. As regards blocking, nasal harmony exhibits an implicational relationship in which blocking by sonorants implies blocking by obstruents, but not vice versa. Two established solutions to this challenge have been proposed in the literature: (i) a universally fixed ranking or (ii) stringent feature co-occurrence constraints. Upon a closer examination, however, it turns out that not all languages adhere to such a strict ranking. I present evidence from a language in which nasal harmony is blocked by non-high vowels, but not by consonants. These data require that a feature co-occurrence constraint against non-high nasal vowels must outrank one against nasal consonants. This is entirely consistent with the current approach, in which a segmental blocker is attributed to a specific, freely ranked feature co-occurrence constraint. In other words, such a constraint can add a segment to a set of blockers. In contrast, no constraint exists that could add a segment to a set of transparent segments. In short, transparency in the current approach is more constrained than blocking.

# Chapter 7

## Triggers

The main argument up to this point was to demonstrate that feature spreading is similar to prosody. In particular, features spread in a binary, hierarchical and recursive way. This means that some segments have different status with respect to the spreading feature than others. One difference is between final and non-final targets (chapter 4). Non-final targets act as propagators of the feature, while final targets do not. This situation can be couched in terms of prominence. In particular, recursive binary-branching feature nodes can be headed by non-final targets, but not by final targets. The distinction between these two types of targets constitutes the first step in establishing a theory of prominence in feature spreading. The second step is the distinction between targets and transparent segments (chapter 5). I propose that transparent segments are also associated with a feature, although in slightly different terms than targets. While targets are linked to the feature via a non-branching feature node, transparent segments are linked to a branching node which is headed by a target or a trigger.

This chapter presents a natural extension of prominence in feature spreading to include another level. This level is the highest in the hierarchy and represents triggers. The data for this additional level come from languages with segments that can be heads of a feature, but do not trigger spreading themselves. In other words, these segments do not initiate spreading, but do act as propagators. The data reviewed give evidence for how feature spreading is organized. More specifically, what the data suggest is that not all feature heads have equal status. Instead, one head is the main head. I call this structure the Head-of-Heads. This representational account is complemented by constraints that penalize the co-occurrence of a Head-of-Heads of a feature [f] with another feature [g].

This section is organized as follows. Section 7.1 introduces the concept of triggering conditions with an example. Section 7.2 presents the representational solution and the relevant constraints. This is followed by analyses of two cases.

Section 7.3 presents triggers in Baiyinna Orochen. Section 7.4 discusses triggers in nasal harmony. Section 7.5 concludes this chapter.

## 7.1 Introduction

In chapter 4, I claimed that feature spreading involves strictly binary and hierarchical branching. The primary evidence for binary branching is supplied by icy targets. These segments can be targets of assimilation, but they also block any further assimilation. According to the current approach, all but the final target are feature heads. This is directly related to icy targets, which can be associated with a feature, but cannot act as heads of a feature. The representational account of feature spreading is complemented by constraints on feature heads. These constraints have an effect on the trigger and all but the final target. Put differently, constraints on heads apply equally to the trigger and non-final targets, but cannot distinguish between triggers and non-final targets. However, such a distinction may be necessary. The literature knows this difference under the term *trigger conditions* (McCarthy 2009; Archangeli & Pulleyblank 1994; Kaun 1995). The data below provide an example.

Baiyinna Orochen (Li 1996; henceforth Baiyinna) displays rounding harmony.<sup>1</sup> This alternation is triggered by a root-initial vowel. In (210) we see that if a root-initial vowel is round, all other vowels within a word are also round. Only non-high vowels trigger harmony in this language.

(210) Baiyinna Orochen rounding harmony (Li 1996:126,129)

|                    |              |                    |                     |
|--------------------|--------------|--------------------|---------------------|
| ol'k <u>o</u> k    | 'hazel'      | tɔ'ɣ <u>o</u>      | 'fire'              |
| oŋ't <u>o</u> t    | 'strange'    | ɔ'r <u>o</u> n     | 'reindeer'          |
| 'mæktʃin- <u>o</u> | 'river bank' | som'sok- <u>jo</u> | 'pasture.INDEF.ACC' |
| bira-'j <u>a</u>   | 'river'      | 'sɔbg <u>o</u>     | 'fish skin'         |

Long vowels depart from this pattern in that they do not trigger rounding themselves, as shown in (211). Long round vowels in word-initial syllables are always followed by non-round vowels.

(211) {oo, ɔɔ} do not trigger harmony (Li 1996:130)

|                           |                   |                  |                    |
|---------------------------|-------------------|------------------|--------------------|
| 'koom <u>ə</u> x <u>ə</u> | 'windpipe'        | kɔɔ'x <u>ən</u>  | 'child'            |
| oo'd <u>ən</u>            | 'velvet'          | 'bɔɔn <u>ə</u>   | 'hail'             |
| 'bool-w <u>ə</u>          | 'slave.DEF.ACC'   | 'gɔɔl-w <u>ə</u> | 'policy.DEF.ACC'   |
| 'bool- <u>ə</u>           | 'slave.INDEF.ACC' | 'gɔɔl-j <u>ə</u> | 'policy.INDEF.ACC' |

<sup>1</sup>Thanks to Joe Pater for bringing these data to my attention.

To summarize, long vowels never trigger rounding harmony: the presence of a round long vowel in a word-initial syllable indicates that the following vowels are not round. This contrasts with short vowels, which trigger rounding of subsequent non-high vowels.

Baiyinna rounding harmony can be analyzed as spreading of the feature [round], which is one of the categories of the active alignment constraint. The targeted structure is determined by transparent segments, as we have seen in chapters 4, 5, and 6. In Baiyinna, only consonants are transparent, which indicates that the targeted structure is a vowel. The domain of application is a prosodic word. Spreading is progressive, which suggests that the alignment constraint sufficient to account for Baiyinna is  $*\omega(\text{[round]}\text{,vowel})$ . Since Baiyinna shows harmony, the alignment constraint must outrank the faithfulness constraint  $\text{DEPLINK[round]}$ .

The remaining question is how to deal with the failure of long vowels to trigger spreading. One solution would be to say that the prosodic properties of long vowels somehow affect harmony. For example, it could be the case that long vowels form a foot and rounding does not apply across foot boundaries. Stress in Baiyinna falls on the rightmost heavy syllable (CVC or CVV), and lacking heavy syllables, stress falls on the final syllable. If we look at the data, we can see that stress placement has no effect on vowel harmony. For example, the form [kooməxə] ‘windpipe’ has initial stress, but has the same rounding pattern as [kɔɔ'xan] ‘child’, which has final stress. Similarly, the stress in [tə'ɣɔ] ‘fire’ is final, whereas in [som'sokjo] ‘pasture’ it is on the penultimate syllable, and in [səbgɔ] ‘fish skin’ it is initial, yet the vowel harmony facts are identical.

Another potential solution in response to this challenge is to invoke constraints on feature heads developed in chapter 4. Recall that icy targets violate a constraint on feature heads. The constraint  $*[\text{F g}]$  (89) prohibits segments linked to [g] to be heads of the feature [f]. This constraint has two effects. First, it stops spreading from a target. In Icelandic, for example, [round] cannot spread from an open vowel [œ] (section 4.3). Second, a constraint on heads also stops spreading from an underlying trigger. In Icelandic, we have seen that an underlying /œ/ also does not trigger spreading. This resembles the situation in Baiyinna, where underlying long {ɔɔ, oo} do not trigger spreading. Hence, a constraint on feature heads is sufficient to inhibit spreading from an underlying {ɔɔ, oo}.

There are several ways how to formalize a constraint that penalizes long heads. One option is Local Conjunction of the constraint against heads of the round feature,  $*[\text{ROUND}]$ , and the constraint against bimoraic segments,  $*\mu\mu$ . The domain of the conjunction is a segment:  $*[\text{ROUND}] \&_{\text{seg}} * \mu\mu$ . This conjoined constraint is violated only by those round vowels that are also long and trigger harmony. The constraint is not violated by short vowels or non-triggering long vowels. The second option would be to take a constraint on feature heads and assume a feature

that is common to long vowels. If we assume [long] as a feature (as in Chomsky & Halle 1968), the relevant constraint on heads in Baiyinna is \*[ROUND long]. While this constraint is formally different from the locally conjoined constraint discussed above, it has identical effects in Baiyinna. In what follows, I use the constraint \*[ROUND long] rather than the alternative to make the parallels to constraints on feature heads explicit. This constraint outranks the alignment constraint and stops rounding triggered by long vowels.

Tableau (212) illustrates the ranking in Baiyinna. I consider two candidates: candidate (a) has no spreading from the long vowel, while candidate (b) shows spreading. Candidate (b) violates \*[ROUND long]. The faithful candidate (a) wins.

(212) bool-wə ‘slave.DEF.ACC’

|                                                                                      | [r]<br>/ b o o l - w ə / | *[RD long] | * $\omega$ ([rd],vow) | DEPLINK[rd] |
|--------------------------------------------------------------------------------------|--------------------------|------------|-----------------------|-------------|
| a.  | [r]<br>b o o l w ə       |            | *                     |             |
| b.                                                                                   | [R]<br>b o o l w o       | *!         |                       | *           |

This simple analysis seems to do the job. Constraints on feature heads can capture the fact that long vowels do not trigger spreading while short vowels do. This is because the constraint on heads \*[ROUND long] stops propagation from long vowels, while it has no effect on short vowels.

Given the data concerning word-initial long vowels and their account based on constraints on feature heads, we would expect long vowels to behave similarly in non-initial syllables. The expected pattern is that long vowels block spreading in any position of the word. Surprisingly, this is not the case. When long vowels occur non-initially not only do they undergo rounding, they also propagate spreading. In (213) we see that long vowels in non-initial syllables are round and so are the following vowels. Forms in which long vowels fail to round \*[o'ləə-mə-tʃə] ‘to cook.INT.PT.T’ or undergo rounding and block further spreading \*[o'loo-mə-tʃə] are unattested. This suggests that long vowels undergo the alternation and act as propagators.

(213) {oo, ə} undergo and propagate harmony (Li 1996:131)

|               |                    |               |                           |
|---------------|--------------------|---------------|---------------------------|
| o'loo-mə-tʃə  | ‘to cook.INT.PT.T’ | gələə-t'kəəxi | ‘log.DIRECT’              |
| sok'koo-mjə   | ‘muddy.CONTEM’     | əpəə-ləə      | ‘rocky hillrock.DESTIN’   |
| dokto-'loo-rə | ‘to harness.PR.T.’ | ə'məəŋ-mə     | ‘fatty deer meat.DEF.ACC’ |



In response to this challenge, I propose a representational extension which is entirely consistent with the current approach. The main contribution of this thesis is that feature spreading entails different levels of prominence. Non-final targets are more prominent than final targets, and all targets are more prominent than transparent segments. The Baiyinna data suggest that there is another level of prominence. This distinction involves triggers. In terms of prominence, a trigger is more prominent than a target. Triggers constitute the highest level of prominence in feature spreading. This relates directly to Baiyinna, in which long vowels are perfectly well-formed targets, but cannot be triggers.

## 7.2 Heads-of-Heads

In the current multilevel branching representation of feature spreading, triggers represent the highest degree of prominence. This is directly mirrored by the position of triggers in the hierarchy. In this section, I propose that while each instance of a feature may be connected to multiple feature heads, one of these heads denotes a trigger. In other words, the triggering head is the main head, or the Head-of-Heads.

I examine Heads-of-Heads in two steps. In section 7.2.1, I discuss how they are represented in the hierarchy of feature spreading. In section 7.2.2, I complement this by specific constraints that apply only to Heads-of-Heads but not other feature heads.

### 7.2.1 Representations

Recall the representations in chapter 4. I have argued that feature spreading involves different levels of prominence, which makes it similar to prosody. The highest level so far were feature heads, which are found on triggers and non-final targets (and indirectly also on non-final transparent segments). Feature heads surface whenever there is a branching feature node. The second level of prominence is full association, which is found on triggers and all targets. Full association is a relation established by a non-branching feature node. The third level of prominence is (regular) association, which is found on triggers, targets and transparent segments. The three levels show an implicational pattern. If a root node is a head, it is also associated with a feature (but not necessarily the reverse). If a root node is fully associated with a feature, it is also associated with a feature (but not necessarily the reverse).

In section 7.1 we have seen that the three levels are not sufficient. Instead, triggers need a separate level of prominence. This can be achieved by singling out the triggering feature head from all other feature heads. The distinction between



the triggering head and all other heads follows straightforwardly from the current, prosody-inspired approach to assimilation.

In (215), we see a representation of assimilation. Of eleven root nodes, the first ten are affected by a spreading feature. The leftmost root node ( $\times_1$ ) is a trigger, and four other root nodes act as targets ( $\times_4, \times_6, \times_7, \times_{10}$ ). The remaining root nodes are transparent. This situation is represented by a hierarchical relation between root nodes and the spreading feature. All affected root nodes are associated with [f]. The trigger and all targets are also linked to a non branching feature node. The trigger and non-final targets are headed.

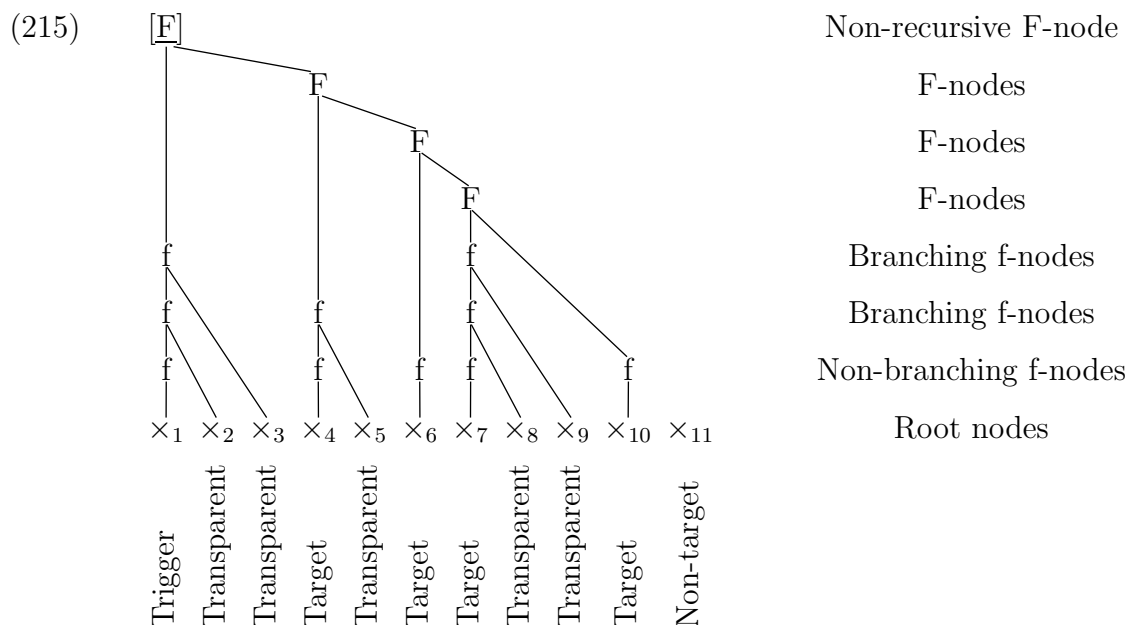

In the representation in (215), the trigger  $\times_1$  can be easily identified. It is graphically aligned with the highest (and non-recursive) F-node. This node is enclosed by square brackets, which denotes the fact that we are dealing with a feature element. The trigger  $\times_1$  is the only head of the feature [f], which is also not a dependent of some binary branching feature node. I call any such head the Head-of-Heads. Surfacing triggers are always the Head-of-Heads. Henceforth, the nodes that single out Heads-of-Heads are also underlined.

I have now shown that triggers constitute the highest level of prominence of the spreading feature. This can easily be represented by a simple extension of the approach proposed in the previous chapters. Of all the feature heads, there is one main head, or the Head-of-Heads, which is the trigger.

### 7.2.2 Constraints

Heads-of-Heads can be referred to by constraints. So far, I have proposed several different constraints. Feature co-occurrence constraints penalize association between a feature and a node (153). Constraints on heads penalize root nodes that are feature heads of some feature while also being associated with another feature (89). Heads-of-Heads are always subsets of all heads of a feature. Here, I propose that the constraints on heads can be restricted such that they apply only to Heads-of-Heads.

The challenge is how to formalize such constraints. First, recall the definition of heads (156), and that heads are segments. The core of the problem is how to single out a Head-of-Heads from all other feature heads. One way of doing this is by defining Heads-of-Heads as heads of the non-recursive feature node, as in (216).

- (216) Head-of-Heads  
 The root node  $\times$  is the Head-of-Heads of [f], iff
- (i)  $\times$  is associated with [f]
  - and
  - (ii)  $\times$  is a head of the non-recursive feature node of [f].

Another way of formalizing Heads-of-Heads is by alignment, which makes the current proposal more in line with feature domain theories (Cassimjee & Kisseberth 1989; Kisseberth 1994; Cole & Kisseberth 1995a,b; Cassimjee & Kisseberth 1998; McCarthy 2004; Smolensky 2006). Recall that assimilation has a clear directional character. First, feature nodes always connect dependent nodes in which one is a head and the other is a dependent. For any given feature, if one of the heads precedes the dependent of the same node, all other heads will precede their dependents. Second, directionality in terms of precedence is ingrained into any alignment constraint. This is directly relevant to triggers, which are always the rightmost or the leftmost segments linked to some feature.<sup>2</sup> If so, then Heads-of-Heads can be defined in terms of alignment. The definition of a left-aligned Head-of-Heads is in (217). The relevant alignment constraint that refers specifically to all root nodes associated with the same feature is in (218). This constraint is violated by any root node that is preceded by another root node, while both are associated with the same feature. All but the leftmost associated root node violate the constraint.

- (217) Head-of-Heads (left variant)  
 Let every  $\times$  be the Head-of-Heads of [f], iff the constraint in (218) is satisfied.

---

<sup>2</sup>See sections 4.5.2 and 6.3 for a discussion of bidirectional spreading, which always consists of two processes with different directionality.

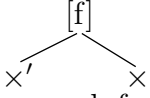
- (218) \* $[f](\times' < \times)$
- a. \* $\langle [f], \times \rangle$  / 
- b. Assign a violation mark for every pair  $\langle [f], \times \rangle$ , iff  
 $[f]$  is associated with the  $\times'$  and  $\times$   
 and  
 $\times' < \times$ .

Either of the two definitions of Head-of-Heads is sufficient. Henceforth, I will assume that Heads-of-Heads are defined as in (216), although the data discussed below is also entirely consistent with the definition in (217).

In (219), we see a template for constraints on Heads-on-Heads. The constraint is violated only by those root nodes that are Heads-of-Heads of a feature  $[f]$  and are associated with another feature  $[g]$  at the same time. Heads-of-Heads are capitalized as normal heads, and underlined in addition.

- (219) \* $[\underline{F} g]$   
 Assign a violation mark for every root node  $\times$ , iff  $\times$  is the Head-of-Heads of a feature  $[f]$  and  $\times$  is associated with  $[g]$ .

The constraint in (219) is not violated by all feature heads. Only a subset of all heads violate it, namely those heads that are also triggers, and thus defined as Heads-of-Heads. In the following section, I show that the predictions of constraints on Heads-of-Heads differ from constraints on regular feature heads. This suggests that both types of constraints are necessary, which I demonstrate on Baiyinna data.

### 7.3 Baiyinna Orochen

I now return to the Baiyinna Orochen data discussed in section 7.1. Recall that Baiyinna has rounding harmony triggered by the word-initial vowel. However, only short vowels trigger harmony, while long ones do not. This suggests that there is a restriction on what segments can act as triggers. Perhaps the simplest approach would be to say that long vowels cannot bear feature heads in Baiyinna. While this approach is good in predicting the restriction on long vowels to trigger spreading as shown in (212), it fails to account for another fact about Baiyinna. More specifically, long vowels undergo spreading if they occur in non-initial syllables. The constraint on heads predicts that these vowels surface as icy targets rather than regular targets, as shown in (214). However, this is not the case. In response to this, I proposed constraints that refer only to triggers, or Heads-of-Heads (sec-

tion 7.2.2). In this section, I show that such constraints adequately account for Baiyinna rounding harmony.

This section consists of two parts. Section 7.3.1 revisits the Baiyinna data and provides more detail. Section 7.3.2 offers an analysis based on a Head-of-Heads constraint.

### 7.3.1 Data

Baiyinna shows multiple spreading processes (Li 1996). Within a word, all vowels are either tense or lax, but this pattern is not relevant here. What is relevant, is rounding harmony that is triggered by the root-initial vowel in a word. The domain of rounding harmony is a prosodic word, which includes the root and all suffixes. As we can see in (220) rounding targets only non-high vowels within the root. When the leftmost root vowel is round, all other non-high root vowels are also round. Roots of the type \*[ol'kək] 'hazel' are not attested.

(220) Harmony targets open vowels within the root (Li 1996:126)

|                   |                |                          |             |
|-------------------|----------------|--------------------------|-------------|
| ol'k <u>o</u> k   | 'hazel'        | tɔ'ɣ <u>ɔ</u>            | 'fire'      |
| oŋ't <u>o</u> t   | 'strange'      | ɔ'r <u>ɔ</u> n           | 'reindeer'  |
| tʃol'p <u>o</u> n | 'morning star' | sɔb'g <u>ɔ</u>           | 'fish skin' |
| soŋ'k <u>o</u> k  | 'pasture'      | ɔ'r <u>ɔ</u> kt <u>ɔ</u> | 'hay'       |
| mo'ɣ <u>o</u> n   | 'silver'       | 'm <u>ɔ</u> ŋk <u>ɔ</u>  | 'boat'      |

The same generalization applies to derivational suffixes. The derivational suffixes in (221) show a four-way distinction in non-high vowels. Roots containing round non-high vowels are always followed by round suffix vowels. High vowels never trigger spreading or block spreading.

(221) Alternating suffixes (Li 1996:129)

- a. Derivational suffix [mə ~ ma ~ mo ~ mɔ] (Li 1996:129)
- |                 |                      |                                   |                     |
|-----------------|----------------------|-----------------------------------|---------------------|
| əwi-'m <u>ə</u> | 'who likes to play'  | o'loo-m <u>o</u>                  | 'who likes to cook' |
| 'um-m <u>a</u>  | 'who likes to drink' | s <u>ɔ</u> n <u>ɔ</u> -m <u>ɔ</u> | 'who likes to weep' |
- b. Indefinite accusative suffix [(j)ə ~ (j)u ~ (j)o ~ (j)ɔ] (Li 1996:129)
- |                             |              |                         |           |
|-----------------------------|--------------|-------------------------|-----------|
| 'm <u>ə</u> ktʃin- <u>ə</u> | 'river bank' | som'sok-j <u>o</u>      | 'pasture' |
| b <u>ɪ</u> ra-'j <u>u</u>   | 'river'      | ɔl <u>ɔ</u> -j <u>ɔ</u> | 'swamp'   |
- c. Immediate imperative 2nd person suffix [kəl ~ kal ~ kol ~ kɔl] (Li 1996:129)<sup>3</sup>
- |                   |            |                                     |            |
|-------------------|------------|-------------------------------------|------------|
| ii-'x <u>ə</u> l  | 'to enter' | olbos-'k <u>o</u> l                 | 'to swim'  |
| taŋ-'k <u>a</u> l | 'to count' | b <u>ɔ</u> d <u>ɔ</u> -x <u>ɔ</u> l | 'to think' |

<sup>3</sup>The [k ~ x] alternation is unrelated to the rounding pattern. Slightly simplified, [k] surfaces after a consonant while [x] surfaces after a vowel.

Long vowels do not trigger harmony when they appear in the word-initial position (222). This applies within roots (222-a) and from roots to suffixes (222-b).

- (222) {oo, ɔɔ} do not trigger harmony (Li 1996:130)
- |    |            |                    |           |                    |
|----|------------|--------------------|-----------|--------------------|
| a. | 'kooməxə   | 'windpipe'         | kɔɔ'xan   | 'child'            |
|    | 'oodəŋ     | 'velvet'           | 'bɔɔnə    | 'hail'             |
|    | 'koorgə    | 'bridge'           | kɔɔ'ŋakta | 'hand bell'        |
|    | 'ooməxi    | 'thigh'            | 'ɔɔxa     | 'sewing container' |
| b. | 'bool-wə   | 'slave.DEF.ACC'    | 'gɔɔl-wa  | 'policy.DEF.ACC'   |
|    | 'bool-ə    | 'slave.INDEF.ACC'  | 'gɔɔl-ja  | 'policy.INDEF.ACC' |
|    | nɔɔŋ-'ma-n | 'she/he.DEF.ACC'   | 'tɔɔd-da  | 'to huddle.PR.T'   |
|    | 'mɔɔ-ma    | 'made of wood'     | 'ɔɔ-ra    | 'to do.PR.T'       |
|    | 'kɔɔ-wa    | 'wine pot.DEF.ACC' | 'kɔɔ-ra   | 'to sharpen'       |

However, long vowels are normal targets just as short vowels are when they appear in any other position of the prosodic word. The data in (223) show long vowels in the second and third syllables.

- (223) {oo, ɔɔ} undergo and propagate harmony (Li 1996:131)
- |               |                    |                |                           |
|---------------|--------------------|----------------|---------------------------|
| o'loo-mo-tʃo  | 'to cook.INT.PT.T' | gɔɔlɔɔ-t'kɔɔxi | 'log.DIRECT'              |
| sok'koo-mɔɔ   | 'muddy.CONTEM'     | ɔɔpɔɔ-'lɔɔ     | 'rocky hillrock.DESTIN'   |
| dokto-'loo-ro | 'to harness.PR.T.' | ɔɔ'mɔɔŋ-mɔɔ    | 'fatty deer meat.DEF.ACC' |

The data in (224) show two alternating suffixes, which are also subject to vowel harmony. In these suffixes, long vowels undergo rounding as expected.

- (224) Alternating suffixes
- |    |                                                                                             |           |                  |           |
|----|---------------------------------------------------------------------------------------------|-----------|------------------|-----------|
| a. | Diminutive suffix [xəən ~ xaan ~ xoon ~ xɔɔn] + definite accusative suffix (Li 1996:131)    |           |                  |           |
|    | luxi-'xəən-mə                                                                               | 'arrow'   | ɔɔpɔɔ-'xoon-mo   | 'bear'    |
|    | bira-'xaan-ma                                                                               | 'river'   | ɔɔlɔɔ-'xɔɔn-mɔɔ  | 'fish'    |
| b. | Causative voice suffix [wkəən ~ wkaan ~ wkoon ~ wkɔɔn] + present tense suffix (Li 1996:131) |           |                  |           |
|    | buu-w'kəən-nə                                                                               | 'to give' | ooloo-w'koon-no  | 'to cook' |
|    | waa-w'kaan-na                                                                               | 'to kill' | lɔɔxo-w'kɔɔn-nɔɔ | 'to hang' |

In short, rounding harmony in Baiyinna is determined by the root-initial vowel. The alternation affects only non-high vowels, while high vowels block harmony. Short vowels always trigger harmony and undergo it. Long vowels, on the other hand, do not trigger harmony, but undergo it.

### 7.3.2 Analysis

I now provide an analysis of Baiyinna rounding harmony. The relevant alignment constraint has [round] as the spreading feature and the prosodic word as the domain. In the current approach, the targeted structure is the complement of the set of transparent segments (172). Consonants are transparent to rounding. Vowels, on the other hand, are not transparent, although only open vowels are targeted. As we have seen in chapter 6, blocking is a separate phenomenon, which is enforced by a high ranked feature co-occurrence constraint. Hence, the Baiyinna pattern surfaces with either the vowel or [open] as the targeted structure. Here, I take the first option, although the second would give the same result. As such, the alignment constraint is  $*\omega([\text{round}], \text{vowel})$ . This constraint outranks the faithfulness constraint  $\text{DEPLINK}[\text{round}]$ , since otherwise no spreading would occur. The blocking pattern of long vowels is attributed to the high ranked constraint on Heads-of-Heads:  $*[\underline{\text{ROUND}} \text{ long}]$ .

The ranking is shown in (225). When the input contains a long round vowel in the first syllable, the effect of the constraint on Heads-of-Heads is similar to the effect of constraints on feature heads, as shown in (225). The candidate with spreading (b) fatally violates the constraint  $*[\underline{\text{ROUND}} \text{ long}]$ , and the faithful candidate (a) wins. Recall the discussion in section 7.1, where I showed that the constraint  $*[\text{ROUND long}]$  has the same effect as Local Conjunction of  $*[\text{ROUND}] \&_{\text{seg}} * \mu\mu$ . Similarly,  $*[\underline{\text{ROUND}} \text{ long}]$  has the same effect as  $*[\text{ROUND}] \&_{\text{seg}} * \mu\mu$ . The notation  $*[\underline{\text{ROUND}} \text{ long}]$  is used here for convenience and to make the comparison between heads and Heads-of-Heads explicit.

(225) bool-wə ‘slave.DEF.ACC’

| $\begin{array}{c} [\text{r}] \\ / \text{ b } \text{oo} \text{l} - \text{w } \text{ə} / \end{array}$              | $*[\underline{\text{RD}} \text{ long}]$ | $*\omega([\text{rd}], \text{vow})$ | $\text{DEPLINK}[\text{rd}]$ |
|------------------------------------------------------------------------------------------------------------------|-----------------------------------------|------------------------------------|-----------------------------|
| a. $\begin{array}{c} [\text{r}] \\   \\ \text{b } \text{oo} \text{l} \text{w } \text{ə} \end{array}$             |                                         | *                                  |                             |
| b. $\begin{array}{c} [\underline{\text{R}}] \\   \\ \text{b } \text{oo} \text{l} \text{w } \text{o} \end{array}$ | *!                                      |                                    | *                           |

When a long vowel is not in the word-initial syllable, the constraint on Heads-of-Heads has a different effect than the constraint on heads. Recall (214) and the fact that the constraint on heads  $*[\text{ROUND long}]$  prefers candidate (b) with an icy target, which is not what happens in Baiyinna. In contrast, (226) shows the effect of the high ranked  $*[\underline{\text{ROUND}} \text{ long}]$ . This constraint is not violated by any

of the candidates, because the trigger is not a long vowel. Crucially, candidate (c) does not violate this constraint even though it contains a feature head violating \*[ROUND long], which is added for reference. The next highest constraint is \* $\omega$ ([rd],vow), which is not violated by candidate (c) with total spreading. This candidate correctly wins.

(226) sokkoom<sub>ɲ</sub>o ‘muddy.CONTEM’

|                 | $\begin{array}{c} [r] \\   \\ / s \ o \ kk \ \text{ə}\text{ə} - m \ ɲ \ \text{ə} / \end{array}$                                     | *[RD long] | * $\omega$ ([rd],vow) | DEPLK[rd] | *[RD long] |
|-----------------|-------------------------------------------------------------------------------------------------------------------------------------|------------|-----------------------|-----------|------------|
| a.              | $\begin{array}{c} [r] \\   \\ s \ o \ kk \ \text{ə}\text{ə} \ m \ ɲ \ \text{ə} \end{array}$                                         |            | *!*                   |           |            |
| b.              | $\begin{array}{c} [R] \\ / \quad \quad \quad \backslash \\   \quad \quad \quad   \\ s \ o \ kk \ oo \ m \ ɲ \ \text{ə} \end{array}$ |            | *!                    | *         |            |
| c. $\leftarrow$ | $\begin{array}{c} [R] \\ / \quad \quad \quad \backslash \\   \quad \quad \quad   \\ s \ o \ kk \ oo \ m \ ɲ \ \text{ə} \end{array}$ |            |                       | **        | *          |

Before I conclude, I want to address two further issues regarding the data. First, the analysis above does not refer to any prosodic constituent other than the fact that vowels are long (i.e., bimoraic) and that harmony applies within a prosodic word. More specifically, stress falls on the rightmost heavy syllable in Baiyinna, which means that in a sequence of two non-initial long vowels only one will be stressed. However, no difference is found with respect to rounding.

Second, the fact that only root-initial vowels are triggers is a separate positional restriction. One way to capture this is by invoking a positional faithfulness constraint that preserves rounding in root-initial syllables (Beckman 1997, 1998). Crucially, this positional effect is independent on the restrictions on heads. More specifically, the constraint on heads \*[ROUND long] applies equally to any position of the word. In the root-initial syllable, where rounding is preserved by positional faithfulness, the constraint \*[ROUND long] blocks rounding of subsequent vowels. In other positions, where rounding spreads from a short word-initial vowel, the constraint \*[ROUND long] blocks spreading beyond a long vowel. Hence, the failure of \*[ROUND long] to capture the Baiyinna rounding harmony is independent of positional faithfulness to the root-initial syllable.

In this section, I have shown that constraints on feature heads are not enough to capture the pattern in Baiyinna. As a remedy, I extended representations to distinguish between non-recursive f-nodes and their heads (Heads-of-Heads) and

other heads. Heads-of-Heads are typically triggers. Constraints on Heads-of-Heads restrict spreading from the trigger, but have no effect on targets.

The situation in Baiyinna is markedly different from the pattern in Icelandic. In Baiyinna long vowels fail to trigger rounding, but they can undergo it. In Icelandic, open vowels similarly never trigger rounding, and they do undergo it. However, they also block any further spreading at the same time. This suggests that the two patterns have two different constraints. In Baiyinna, the active constraint penalizes triggers, or Heads-of-Heads, while the active constraint in Icelandic penalizes triggers and non-final targets, or all feature heads. The two constraints are independently needed, as one cannot replicate the effect of the other.

The failing triggers are not specific to Baiyinna, but are also found in other languages. Lule Saami (Morén-Duolljá 2010) is one such case. In this language, rounding harmony is triggered only by short vowels, and never by long vowels, which also undergo spreading. Assimilation patterns other than vowel harmony with failing triggers are also quite common. In the next section, I review these data in various types of nasal harmony. In section 8.5.4, I examine a case of failing triggers in consonant harmony.

## 7.4 Nasal harmony

In this section, I look at triggers in nasal harmony. The cross-linguistic overview of triggers in nasal harmony demonstrates that different languages have different triggers. For example, in some languages only nasal vowels can act as triggers, while in others only nasal stops do. These data are reviewed in section 7.4.1. I extend the idea of Heads-of-Heads to nasal harmony and show that the relevant constraints can successfully account for the disparity between triggers across languages. I then illustrate this on a single language in section 7.4.2.

### 7.4.1 Cross-linguistic generalizations

Recall section 6.6, which provides a cross-linguistic review of blocking and transparency in nasal harmony. What has not been the focus of the discussion so far is the fact that languages differ with respect to what segments trigger nasal harmony.

The most typical triggers of nasal harmony are nasal sonorant stops and nasal vowels (Walker 1998/2000). With respect to these triggers, languages fall into three groups, presented in Table 7.1. In the first group of languages, both nasal sonorant stops and nasal vowels trigger nasal harmony, as in Epena Pedee. The second group only shows spreading from nasal sonorant stops, but not from nasal vowels. Nasal vowels cannot trigger nasalization themselves, but do not block



nasalization initiated by a nasal sonorant stop. An example of such a language is Johore Malay. The third group, on the other hand, has nasalization triggered by vowels but not by nasal sonorant stops. At the same time, nasal sonorant stops do not interfere with nasalization triggered by vowels. An example is found in Applecross.<sup>4</sup>

| NASAL STOPS | VOWELS | EXAMPLE LANGUAGE (SECTION)                                                   |
|-------------|--------|------------------------------------------------------------------------------|
| ✓           | ✓      | Epena Pedee (2.1.3),<br>Warao, Kolokuma Ijo (Piggott 1992, Walker 1998/2000) |
| ✓           |        | Sundanese, Capanahua (2.1.3), Johore Malay (6.6.1)                           |
|             | ✓      | Applecross (2.2.2), Ikwere (4.5), Mòbà (6.6.3)                               |

Table 7.1: Triggers of nasal harmony

The fact that only one type of segments triggers nasal harmony is not surprising. Such a restriction can be captured by constraints on Heads-of-Heads. In the previous section, we have seen such an analysis for rounding harmony. In languages like Sundanese, nasal vowels cannot trigger harmony, and this can be attributed to a high ranked constraint on Heads-of-Heads: \*[NASAL vowel]. The effect of this constraint is similar to the one in Baiyinna. Vowels can propagate the feature [nasal], but do not trigger nasalization.

In the following section, I revisit nasal harmony in Mòbà and focus on triggers. I show that nasal sonorant stops do not trigger nasal harmony, yet they undergo it. This pattern is parallel to the Baiyinna Orochen round harmony. Both languages offer evidence for different treatment of triggers compared to targets and this can be captured by constraints that are specific to Heads-of-Heads.

### 7.4.2 Mòbà

Recall Mòbà nasal harmony discussed in section 6.6.3. Nasal harmony is regressive and triggered by vowels. Only sonorants are targeted, while obstruents are transparent. Non-high vowels block spreading. In this section, I focus on the behavior of nasal sonorant stops.

The data in (227) show that nasalization in Mòbà is regressive. It applies within a prosodic word (Ajíbóyè & Pulleyblank 2008). Only nasal vowels can serve as triggers (227-a). The fact not yet mentioned is that nasal sonorant stops fail to trigger harmony, as shown in (227-b). For example, if /m/ triggered nasalization,

<sup>4</sup>There is only one language that falls outside this typology. In Ennemor (Hertzson & Marcos 1966) triggers are nasal continuants (including sonorant consonants and fricatives) but not by nasal sonorant stops. The interesting part about Ennemor is that nasal harmony does not propagate beyond nasal sonorant stops, which act as icy targets.

we would expect \*[ĩmɛɛ] ‘laziness’ and not the actually attested [ĩmɛɛ]. However, nasal sonorant stops do not interfere with nasal harmony triggered by another segment (227-c). While there are no direct alternations to unequivocally show this point, there is indirect evidence. In particular, while there are many forms of the type [ũmũmĩ] ‘drinking cup’ or [ũñĩra] ‘difficulty’ there are no forms like \*[umũmĩ] or \*[umũmĩ].

(227) Mòbà nasal harmony (Ajíbóyè & Pulleyblank 2008)

a. Triggered by vowels

| VERB | NOUN |        | VERB | NOUN |           |
|------|------|--------|------|------|-----------|
| ʃɛ   | ũ-ʃɛ | ‘eat’  | ĩĩ   | ũ-ĩĩ | ‘walk’    |
| fɛ   | ũ-fɛ | ‘like’ | ỹĩ   | ũ-ỹĩ | ‘praise’  |
| ko   | ũ-ko | ‘pack’ | nĩ   | ũ-nĩ | ‘have’    |
|      |      |        | ã    | ũ-ã  | ‘measure’ |

b. Not triggered by nasal stops

|       |                     |
|-------|---------------------|
| ũmoʃi | ‘NAME OF A VILLAGE’ |
| ĩmɛɛ  | ‘laziness’          |
| ũmoru | ‘PERSONAL NAME’     |

c. Nasal stops are propagators

|       |                |
|-------|----------------|
| ĩmũ   | ‘nose’         |
| ũmũmĩ | ‘drinking cup’ |
| ũñĩra | ‘difficulty’   |
| ũmũra | ‘preparedness’ |

We have already seen an analysis of the basic pattern in section 6.6.3. In Mòbà, \* $\omega$ (sonorant, [nasal]) outranks DEPLINK[nasal]. Furthermore, \* $\omega$ (sonorant, [nasal]) is outranked by MAXLINK[nasal], which effectively preserves nasality in the presence of blockers.

I illustrate the effect of these constraints in two steps. In (228), I account for the fact that nasal sonorant stops fail to trigger nasal harmony. Candidate (a) has no spreading, while candidate (b) spreads nasality to the preceding vowel. Candidate (b) has a Head-of-Heads of [nasal] that is also a nasal sonorant stop. Thus, this candidate fatally violates the high ranked constraint on Heads-of-Heads \*[NASAL sonorant stop]. Candidate (a) with no spreading wins instead.

(228) ãmɛlɛ ‘laziness’

|                  | $\begin{array}{c} [n] \\ / i \ m \ \varepsilon \ l \ \varepsilon / \end{array}$                                     | *[NAS son stop] | * $\omega(\text{son}, [nas])$ | DEPLK[nas] |
|------------------|---------------------------------------------------------------------------------------------------------------------|-----------------|-------------------------------|------------|
| a. $\rightarrow$ | $\begin{array}{c} [n] \\ i \ m \ \varepsilon \ l \ \varepsilon \end{array}$                                         |                 | *                             |            |
| b.               | $\begin{array}{c} [N] \\ / \ n \ \backslash \\   \ \backslash \\ i \ m \ \varepsilon \ l \ \varepsilon \end{array}$ | *!              |                               | *          |

In (229), I we see an input with a nasal vowel and a nasal sonorant stop. Four candidates are relevant in the present context. Candidate (a) has no spreading, candidate (b) has spreading from the blocking obstruent, candidate (c) has spreading from the vowel, while candidate (d) displays fusion and spreading from the nasal vowel. It is this last candidate that wins, while the rest violate at least one of the high ranked constraints. Fusion is a pattern that is common in phonology otherwise, so it is not surprising that it is also found in assimilation. In candidate (c), the two [nasal] autosegments fuse and the original association lines are preserved, hence MAXLINK[nasal] is not violated. This candidate has the Head-of-Heads on the vowel, hence the constraint \*[NASAL sonorant stop] is not violated.

(229) ãmũ ‘nose’

|                  | $\begin{array}{c} [n]_1 \ [n]_2 \\ / i \ m \ \underset{\cdot}{u} / \end{array}$                                                   | *[N son stop] | MAXLK[n] | * $\omega(\text{son}, [n])$ | DEPLK[n] |
|------------------|-----------------------------------------------------------------------------------------------------------------------------------|---------------|----------|-----------------------------|----------|
| a.               | $\begin{array}{c} [n]_1 \ [n]_2 \\ i \ m \ \underset{\cdot}{u} \end{array}$                                                       |               |          | *!***                       |          |
| b.               | $\begin{array}{c} [N]_1 \\ / \ n \ \backslash \\   \ \backslash \\ i \ m \ \underset{\cdot}{u} \end{array}$                       | *!            |          | **                          | *        |
| c.               | $\begin{array}{c} [N]_2 \\ / \ N \ \backslash \\ / \ \backslash \\   \ \backslash \\ i \ m \ \underset{\cdot}{u} \end{array}$     |               | *!       |                             | **       |
| d. $\rightarrow$ | $\begin{array}{c} [N]_{1,2} \\ / \ N \ \backslash \\ / \ \backslash \\   \ \backslash \\ i \ m \ \underset{\cdot}{u} \end{array}$ |               |          |                             | *        |

If we compare the triggers in Mòbà and Baiyinna, we can see several differences and one common property. An important difference is that in Mòbà, the [nasal]

feature of the non-trigger fuses with the spreading [nasal] from the vowel trigger. In Baiyinna rounding harmony this is not the case, because [round] is always present in the initial syllable, but not otherwise. Nevertheless, both patterns can be unified in that they have segments that do not trigger spreading. The current analysis based on Heads-of-Heads unifies these two patterns.

I have now extended the notion of Heads-of-Heads to nasal harmony, and attributed the failure to spread to a high ranked constraint on Heads-of-Heads. These constraints may be ranked freely with respect to the relevant alignment constraints. The prediction of this approach is that any segment may fail to trigger harmony, but undergo assimilation if triggered by another segment. This is entirely consistent with the cross-linguistic generalization about nasal harmony triggers. In some languages only nasal vowels trigger nasal harmony, while nasal sonorant stops do not. In others, the situation is the opposite. Constraints on Heads-of-Heads may refer to nasal vowels or nasal sonorant stops, which predicts both types of languages: those in which spreading is triggered by nasal vowels and those in which spreading is triggered by nasal sonorant stops.<sup>5</sup>

## 7.5 Summary

In this chapter, I looked at failing triggers. These segments have the spreading feature underlyingly, yet they are never triggers. At the same time they are regular targets of assimilation. This is unlike icy targets, which never trigger, but also block further spreading, although they are targets themselves. While icy targets can be accounted for by constraints on feature heads, failing triggers cannot.

I propose a representational solution to this challenge. Of all feature heads of a particular spreading process, one head is the main head, or the Head-of-Heads. If so, then a trigger will always be the Head-of-Heads. Much like constraints can refer to feature heads, they can also refer to Heads-of-Heads. These constraints prohibit spreading from a particular trigger. The approach straightforwardly follows from the hierarchical representation of feature spreading.

I have now established four levels of prominence in feature spreading. Transparent segments, all targets and triggers are associated with a feature. Only the last two are linked to a non-branching feature node. Triggers and non-final targets are heads of a feature. Finally, only triggers are Heads-of-Heads. This means that triggers have more structures than other segments. Consequently, more markedness constraints apply to triggers, followed by non-final targets, tar-

---

<sup>5</sup>The extension to other feature combinations, which is also predicted under the current approach, might come from languages where the set of triggers is larger, such as Ennemor (Hertzson & Marcos 1966). A detailed analysis of all possible combinations is ultimately beyond the scope of this thesis.

gets and transparent segments. This is consistent with the fact that assimilation is a neutralization pattern. Since more markedness constraints apply to triggers, the contrast is neutralized most on triggers, followed by non-final targets, final targets and transparent segments.



## **Part III**

# **Assimilation as Interaction**





# Chapter 8

## Parasitic assimilation

Chapters 4–7 provided an overview of different types of segments. The evidence reviewed is accounted for by invoking a simple representational solution in which all branching is strictly hierarchical and maximally binary. More specifically, hierarchy and binarity allows for a formal distinction between triggers, targets and transparent segments. Constraints provide a tool that drives assimilation and complement the representational differences.

In this chapter, I review cases in which hierarchy is obscured by another condition on spreading. This condition is in the similarity between a trigger and its targets. The idea behind this condition is that like things interact. More specifically, sometimes spreading of one feature depends on another feature. Spreading of a particular feature occurs only when a trigger–target pair agrees in an otherwise independent feature. This type of assimilation is known as *parasitic* harmony in the literature.

I first show that parasitic harmony cannot be explained by alignment constraints or constraints on feature heads. Alignment constraints drive spreading regardless of what the trigger is. Constraints on feature heads restrict possible triggers and non-final targets, but say nothing about the similarity among these segments. In response to this challenge, I propose another class of constraints. Agreement constraints have a broad use in the literature. I make use of the fact that feature spreading involves multiple association lines to the spreading feature. The new agreement constraints require that segments that are linked to one feature agree in an additional feature. The effect of agreement constraints can be seen most clearly when they are ranked above alignment constraints. In these cases, agreement prohibits spreading to some segments targeted by the alignment constraints.

This section is organized as follows. Section 8.1 presents a case of parasitic vowel harmony and shows that constraints proposed so far cannot capture them. Section 8.2 introduces agreement constraints. Section 8.3 offers an agreement-

based analysis of parasitic rounding harmony in Yowlumne. The two following sections are typological studies of different parasitic patterns. Section 8.4 looks at the typology of rounding harmony and gives a unified analysis of the attested patterns using all constraints proposed so far (alignment constraints, feature co-occurrence constraints and constraints on feature heads) and agreement constraints on top of that. Section 8.5 gives an overview and an account of consonant harmony. Section 8.6 concludes.

## 8.1 Introduction

Parasitic harmony is a well-documented phenomenon (Cole 1987; Cole & Trigo 1988; Kaun 1995, 2004; Krämer 2003). In parasitic *vowel* harmony, spreading of a feature depends on another *vocalic* feature. For instance, rounding spreads from high vowels to other high vowels, but not to other segments. At the same time, rounding spreads from non-high vowels to other non-high vowels, but not to high vowels. This shows that assimilation patterns sometimes depend on agreement between the trigger and the target. More broadly, in many cases of assimilation like things interact.

A famous example of parasitic vowel harmony is rounding harmony in the Yowlumne dialect of Yokuts (formerly known as Yawelmani). In Yowlumne, rounding applies only if the trigger and the target are identical in vowel height, as shown in (230). Round high vowels are followed by round high vowels, but by unrounded open vowels. Conversely, round open vowels are followed by round open vowels, but by unrounded high vowels. In other words, rounding applies only if the trigger and the target agree in vowel height.

- (230) Yowlumne vowel harmony (Kuroda 1967:10,14)
- |                 |                 |                          |
|-----------------|-----------------|--------------------------|
| gij'-hin        | gij'-taw        | 'touch'                  |
| muṭ-h <u>un</u> | muṭ-taw         | 'swear'                  |
| xat-hin         | xat-taw         | 'eat'                    |
| gop-hin         | gop-t <u>ow</u> | 'take care of an infant' |
| 'AORIST'        | 'NDR.GER'       |                          |

The Yowlumne pattern is markedly different from any other alternation discussed so far. On the one hand, all vowels can become targets. On the other, the environment in which they do become targets is dependent on their similarity to the trigger. This differs from the previously analyzed cases of assimilation, in which targets can be radically different from the trigger. For example, vowel harmony is sometimes initiated by consonants. Nasal harmony may affect most segments, but may be triggered only by vowels and/or nasal stops. The very idea that I have been advancing so far is that feature spreading is hierarchical and involves different

levels of prominence. Hence, the focus has been on cases in which triggers differ from targets or in which final targets differ from non-targets. Parasitism involves no such parameter.

This suggests that the constraints and representations used so far are unable to account for parasitic harmonies. I now demonstrate this for Yowlumne vowel harmony. The constraints used so far are of four types: (i) alignment constraints, (ii) faithfulness constraints, (iii) feature co-occurrence constraints and (iv) constraints on heads and Heads-of-Heads. The potentially relevant constraints in Yowlumne are in (231). First, in Yowlumne [round] spreads rightwards to vowels, within a prosodic word. The first possible alignment constraint is  $*\omega([\text{round}], \text{vowel})$ . Another constraint targets open vowels:  $*\omega([\text{round}], \text{open})$ . The third possible alignment constraint targets high vowels:  $*\omega([\text{round}], \text{high})$ . However, the current approach excludes the existence of both  $*\omega([\text{round}], \text{open})$  and  $*\omega([\text{round}], \text{high})$ . This is because the spreading feature and the targeted structure are related to one another. This connection is typological and most commonly phonetically grounded. More specifically, the locality disparities we see in assimilation patterns across languages are due to the fact that Con contains only a subset of these constraints. While I will use the two constraints for expositional purposes, I will specifically argue against  $*\omega([\text{round}], \text{high})$  on empirical grounds in section 8.4.5. Second, spreading involves linking of [round], which violates  $\text{DEPLINK}[\text{round}]$ . Third, the potentially active feature co-occurrence constraints are the ones involving round vowels and two different vowel heights:  $*[\text{round high}]$  and  $*[\text{round open}]$ . Finally, the constraints on heads may effectively stop spreading, which is what actually happens in Yowlumne. Two such constraints are relevant:  $*[\text{ROUND high}]$  and  $*[\text{ROUND open}]$ . In what follows, I consider only combinations of one trigger and one target, hence the effect of constraints on Heads-of-Heads (216) does not differ from constraints on heads.

- (231) Potentially relevant constraints in Yowlumne
- a. Alignment constraints (sections 2.2.2, 3.2.4, 5.2.2)
    - $*\omega([\text{round}], \text{vowel})$
    - $*\omega([\text{round}], \text{high}) ??$
    - $*\omega([\text{round}], \text{open})$
  - b. Faithfulness constraints (sections 2.2.2, 5.2.2)
    - $\text{DEPLINK}[\text{round}]$
  - c. Feature co-occurrence constraints (section 4.2.4, 6.2.1)
    - $*[\text{round high}]$
    - $*[\text{round open}]$
  - d. Constraints on heads (sections 4.2.4, 5.2.2, 7.2)
    - $*[\text{ROUND high}]$
    - $*[\text{ROUND open}]$

I now show the effect of these constraints for four possible combinations of rounding and vowel height. The simplest way to compare all four combinations is by using a comparative tableau (Prince 2000/2002) as in (232). I leave out inputs, which are identical to the candidates without spreading (as regards the feature [round]). Association lines represent full association, while dependent association to transparent segments is left out. What is evident from the tableau below is that there is no constraint that prefers only winners. Thus, there can be no consistent ranking under which all attested candidates surface.

(232) Inconsistency in Yowlumne

| Winner ~ Loser                                                                                                                                 | *[RD hi] | *[RD op] | *[rd hi] | *[rd op] | * $\omega$ ([rd],v) | * $\omega$ ([rd],hi) | * $\omega$ ([rd],op) | DEFLK[rd] |
|------------------------------------------------------------------------------------------------------------------------------------------------|----------|----------|----------|----------|---------------------|----------------------|----------------------|-----------|
| $\begin{array}{c} \text{[R]} \qquad \qquad \text{[r]} \\ \diagdown \qquad \diagup \\ \text{m u t' h u n} \sim \text{m u t' h i n} \end{array}$ | L        |          | L        |          | W                   | W                    |                      | L         |
| $\begin{array}{c} \text{[r]} \qquad \qquad \text{[R]} \\ \diagdown \qquad \diagup \\ \text{m u t' t a w} \sim \text{m u t' t o w} \end{array}$ | W        |          |          | W        | L                   |                      | L                    | W         |
| $\begin{array}{c} \text{[R]} \qquad \qquad \text{[r]} \\ \diagdown \qquad \diagup \\ \text{g o p t o w} \sim \text{g o p t a w} \end{array}$   |          | W        |          | L        | W                   |                      | W                    | L         |
| $\begin{array}{c} \text{[r]} \qquad \qquad \text{[R]} \\ \diagdown \qquad \diagup \\ \text{g o p h i n} \sim \text{g o p h u n} \end{array}$   |          | L        | W        |          | L                   | L                    |                      | W         |

We can conclude that none of the previously proposed constraints allows for the parasitic pattern found in Yowlumne. In response to this challenge, one option would be to propose yet another representational modification of spreading. This is an option taken by Archangeli (1984, 1985), who proposes that rounding is a feature dependent of vowel height feature node. Hence, rounding can spread from one [+high] node to another, but not from a [+high] node to a [-high] node.

However, Archangeli's approach has no direct parallel in the model advocated in this thesis. As pointed out in section 2.2.1, I do not make any assumptions regarding the organization among *different* features. According to the current model, each feature is simply linked to a root node, and features are not dependent of one another. All interactions between features are attributed to constraints. I will thus take a different route, which is to propose a new constraint. Agreement constraints are widely used in the phonological literature (Lombardi 1999; Baković 2000; Pulleyblank 2002; Blaho 2008). These previous approaches used agreement constraints as the driving force for assimilation. In the current context, however,

alignment constraints achieve this. Hence, I will use agreement along with alignment constraints. This allows for a significant modification of some problematic elements of agreement constraints.

## 8.2 Agreement

Phonologists have used several different kinds of constraints that drive assimilation. One type of constraints are alignment constraints. I have used these constraints extensively. In section 2.2.2, I demonstrated that these may be formalized such that they are categorical. In chapter 3, I argued that alignment constraints can account for assimilation and other phenomena, such as dissimilation and derived environment effects. Yet, as we have seen in the previous section, alignment constraints alone cannot model parasitic phenomena. Another type of constraints are agreement constraints. These constraints require that adjacent segments agree in their specification of a particular feature [f]: segments violate an agreement constraint if one is linked to [f], while the other is not. This property of agreement constraints reveals that they are formally disjunctive: they are violated by a sequence of a segment linked to [f] followed by a segment not linked to [f], or when the order of the two segments is reversed. In the current context, this sounds promising: what happens in Yowlumne is that spreading is dependent on the feature specification of two segments. That is, rounding spreads to a target if and only if such a target also *agrees* in vowel height.

In this section, I extend the notion of agreement to the current approach. However, in the light of the current approach to feature spreading, these constraints need to be modified. In particular, agreement constraints can make reference to segments linked to a particular feature node. This way the agreement constraints need no reference to adjacency, which is a problematic definitional component of the classic agreement constraints.

### 8.2.1 Classic Agreement

A classic agreement constraint requires that two segments agree in some feature. In (233), I present several definitions of a particular kind of agreement constraint, AGREE[voice].

- (233) AGREE[voice]
- a. Adjacent segments must have the same value of the feature [voice]. (Baković 2000:4)
  - b. Obstruent clusters must agree in voicing. (Lombardi 1999:272)

- c. A segment has [voice] iff its neighboring segments have [voice]. (Blaho 2008:64,139)

The definitions in (233) include reference to three variables: one feature and two segments. The constraint AGREE[voice] is violated when two segments are adjacent to one another and only one is associated with [voice]. Conversely, AGREE[voice] is satisfied in three situations: (i) by two adjacent segments that are voiced or (ii) voiceless, and (iii) by any two non-adjacent segments.

I now first consider the effect of agreement constraints on two adjacent segments. Recall that Russian (3) has voicing assimilation in which two adjacent obstruents always agree in voicing. This is clearly an assimilation pattern according to the criteria set in chapter 2: voicing spreads from one segment to another. An output that contains a sequence of a voiceless and a voiced obstruent is never optimal. Classic agreement constraints can perfectly capture assimilation. In (234) we see an input containing a cluster of two obstruents which disagree in voicing. The high ranked constraint AGREE[voice] prefers candidate (b) with both obstruents voiced over the faithful candidate (a). Here, the direction of spreading is not a crucial issue; this will be further addressed in chapter 9.

(234) Agreement drives assimilation

| ot-brosit <sup>j</sup>                                                                                       | AGREE[voice] | DEPLINK[voice] |
|--------------------------------------------------------------------------------------------------------------|--------------|----------------|
| a. otbrosit <sup>j</sup>                                                                                     | *!           |                |
| b.  odbrosit <sup>j</sup> |              | *              |

The first prediction of classic agreement constraints is correct: they are perfectly able to capture assimilation. The second prediction involves non-adjacent segments. Since AGREE[voice] in (233) explicitly refers to adjacent/neighboring segments, any two non-adjacent segments vacuously satisfy it. Adjacency is therefore a crucial ingredient of any classic agreement constraint. While adjacency is undoubtedly an important concept in phonology (Howard 1972; Jensen 1974; Odden 1994; Halle 1995), its reference in a constraint that prefers spreading is somewhat problematic. The problem is that the constraint prefers any non-adjacent segments to adjacent ones. More specifically, while two adjacent segments may or may not satisfy an agreement constraint, two non-adjacent segments always do. This entails that agreement constraints prefer candidates with epenthesis, when DEPLINK[voice] outranks DEP. This is shown in (235). Candidate (b) with spreading fatally violates DEPLINK[voice], which is not violated by candidate (c) with epenthesis.

(235) Agreement drives epenthesis

|    | ot-brosit <sup>j</sup>   | AGREE[voice] | DEPLINK[voice] | DEP |
|----|--------------------------|--------------|----------------|-----|
| a. | otbrosit <sup>j</sup>    | *!           |                |     |
| b. | odbrosit <sup>j</sup>    |              | *!             |     |
| c. | ☞ otəbrosit <sup>j</sup> |              |                | *   |

Tableau (235) shows that agreement constraints can generate a pattern in which epenthesis surfaces only when obstruents disagree in voicing. This is an instantiation of the too-many-solutions/too-many-repairs problem (Pater 1999; Wilson 2000, 2001; Steriade 2001, 2001/2008; Blumenfeld 2006; Baković 2007). We know of no case of assimilation that triggers epenthesis. Consequently, a constraint driving feature spreading should not be satisfied by adding a segment. Because agreement constraints can generate such a pattern, their modification appears warranted.

We have now seen that adjacency is one good reason why classic agreement constraints should be modified. There are two further arguments. If we examine the definition of the agreement constraint in (233) more closely, we see that it actually makes reference to two other concepts. The first one is the notion of agreement. This is a relation between two adjacent segments, which must be identical with respect to the relevant feature. The concept of agreement between adjacent root nodes captures a disjunctive relationship, which becomes apparent if one reformulates the constraint such that it includes a negative condition, as in (236). This new, more formal, definition is directly parallel to the one in (233). The constraint is violated under two conditions, each of which refers to a particular combination of the two root nodes. Disjunctive constraint definitions are less desirable than non-disjunctive. In particular, disjunctive constraints have two or more non-overlapping conditions, which could be at least formally split into separate constraints. Consider the agreement constraint in (236), which could be split into the constraint that is violated under condition (i), whereas the other is violated under condition (ii). There is a paradox between these two simple constraints and the joint disjunctive constraint. On the one hand, the simple constraints are not always supported by various assimilation patterns. In particular, the constraint violated under condition (i) triggers progressive voicing, which is not attested (this will be further discussed in section 9.2). On the other hand, when the two separate constraints are supported, there is no reason to have a constraint that does the job of either—but not both—at the same time. This contradicts the fundamental OT principle, namely that constraints are strictly ranked to one another. Disjunctive constraints seem to require exactly the opposite, namely that the simple constraints are not strictly ranked to one another.

- (236) AGREE[voice] (negative version)  
 Let  $\times_1, \times_2$  be adjacent root nodes.  
 Assign a violation mark iff
- (i)  $\times_1$  is associated with [voice] and  $\times_2$  is not
  - or
  - (ii)  $\times_1$  is *not* associated with [voice] and  $\times_2$  is.

Second, the definition of agreement in (233-b) actually refers to two features rather than one, although this is not made explicit. In particular, only obstruents incur violation marks, while sonorants do not. That is, a sequence of one sonorant followed by an obstruent should not violate AGREE[voice]. This is independent of whether sonorants have the feature [voice] or not. If sonorants have the feature [voice], then the constraint AGREE[voice] would trigger voicing of all presonorant obstruents, generating a language with only voiced clusters of obstruents, except in the position before a pause. On the other hand, if sonorants do not have the feature [voice], then AGREE[voice] would trigger voicing of sonorants, but only when adjacent to a voiced obstruent. This paradox can be avoided if AGREE[voice] refers to the feature common to all obstruents. In this thesis, I use the feature [obstruent]. This feature is a privative correspondent of [–sonorant] (Lombardi 1995a, 1999). The modified agreement constraint is defined in (237).

- (237) AGREE[voice] (negative, two features)  
 Let  $\times_1, \times_2$  be adjacent root nodes.  
 Assign a violation mark iff
- (i)  $\times_1$  and  $\times_2$  are associated with [obstruent]
  - and
  - (ii-a)  $\times_1$  is associated with [voice] and  $\times_2$  is not
  - or
  - (ii-b)  $\times_1$  is not associated with [voice] and  $\times_2$  is.

Only one of the definitions in (233) actually contains reference to two features. Yet, the two features are also needed in the remaining two definitions of AGREE[voice] in (233). The reason why Blaho (2008) does not include obstruents in the definition of AGREE[voice], is that she proposes a domain boundary, which is introduced by vowels and which at the same time excludes vowels from the effect of the constraint. Such a solution makes sense in her framework, in which features are language-specific. In the current approach, however, features are universal. This means that the constraint that refers to [voice] needs to account for cross-linguistic variation, which also exhibits voicing assimilation between obstruents on the one hand and vowels and sonorants on the other. In other words, voicing assimilation



involves only obstruents in some languages, but also sonorants in others. Voicing assimilation is further analyzed in section 9.3.

We can conclude that classic agreement constraints have very complex definitions. These definitions may be disjunctive, and require reference to adjacency and two features. Adjacency has been shown to be the most problematic element. I will adopt a revised version of agreement constraints that entirely dispose of adjacency by taking advantage of the representation of feature spreading and alignment constraints.

### 8.2.2 Agreement in BDT

Many of the challenges with agreement constraints come from their adjacency requirement. One way to improve their definition is to entirely remove any reference to adjacency. This option is available in BDT because of two facts. First, any trigger–target pair can be defined as being linked to the same autosegment. Second, alignment constraints determine what the targets are in terms of locality and the domain.

The question here is how to formulate such a constraint. I will take the formulation of Blaho (2008) as the starting point. In (238), I reformulate her constraint so that it refers to association lines and root nodes. Recall that in the current approach, I assume that assimilation driving constraints can only be satisfied by full association (between a feature and its targets), but not by dependent association (between a feature and its transparent segments). In other words, while there might be data to support constraints enforcing both types of association, I will only consider those constraints that prefer full association. This also applies to agreement constraints.

- (238) AGREE[f] (Blaho 2008:64,139; slightly modified)  
 A root node is fully associated with [f] iff its neighboring root nodes are fully associated with [f].

I have argued that this definition contains two problematic points: it refers to adjacency (i.e., neighborhood) and lacks the targeted structure (i.e., reference to obstruents). I now propose a solution to these two challenges.

Adjacency is required in classic agreement constraints to drive assimilation in the first place. The idea behind this approach is that a string of segments with alternating values of a feature is more marked than a string where all segments have the same value. That is, a featural change in a string incurs a violation mark. Strings can be broken down into ordered pairs of adjacent segments, which turns out to be the most straightforward method for evaluation. The only other alternative for classic agreement constraints would be to compare all pairs of segments,

regardless whether they are adjacent or not. Since the number of pairs increases exponentially with string length, this alternative would have to be restricted to a domain.

I instead propose that agreement constraints do not need to refer to adjacency. This is because in Autosegmental Phonology, triggers and targets are all fully associated with the spreading feature. All segments associated with a feature can be directly evaluated, and this is even if they are not adjacent.

The second problem of the traditional agreement constraints is related: while they formally refer only to one feature, their implementations usually refer to two. In the context of AGREE[voice] (237), the spreading feature is [voice], while the targeted structure is [obstruent]. Here, the first one could be called the spreading feature, while the second is the targeted structure. I propose these two are required in the new definition.



The constraint AGREE([f],g) is in (239). It makes reference to two features. Their feature nodes are fully associated with the relevant root nodes. Unlike alignment, agreement requires no f-precedence relation among the two features. The definition also does not require any notion of adjacency or neighborhood. The abbreviated name of the agreement constraint contains two features, and the spreading feature is in square brackets, which is directly parallel to alignment constraints—e.g. \* $\omega$ ([f],g).

(239) AGREE([f],g)

A root node is fully associated with features [f] and [g] iff all root nodes fully associated with that [f] are also fully associated with some [g].

The constraint in (239) is evaluated on the level of root nodes. The violating configuration, however, involves a single feature that is fully associated with two root nodes, only one of which is linked to [g]. Crucially, this constraint is not violated when the two root nodes agree in feature [g], which means that they are either both fully associated with [g] or neither is. This is shown in (240). All but the final candidate contain two root nodes. Candidates (a–e) exhibit spreading. In candidate (a), both root nodes are fully associated with [g]. Hence, the agreement constraint is satisfied. Candidate (b) vacuously satisfies the constraint since no root node is fully associated with [g]. In contrast, candidates (c) and (d) have only one root node fully associated with [g]. These two candidates violate AGREE([f],g), because they have two root nodes that are fully associated with the same instance of [f], yet only one of the two root nodes is fully associated with [g]. In other words, it is not the case that all root nodes fully associated with [f] are also fully associated with some [g]. Directionality has no effect here, so candidates (e) and (f) are both violated. So far, the constraint seems to be doing its job, which is preferring spreading of [f] when the two fully associated segments are linked to [g].

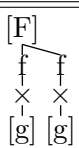
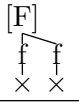
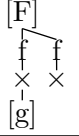
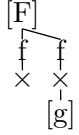
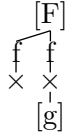
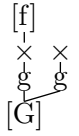
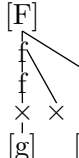
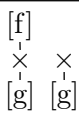
(240) AGREE([f],g) evaluations

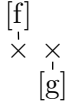
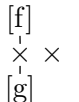
|                                                                                        | AGREE([f],g) |
|----------------------------------------------------------------------------------------|--------------|
| a.    |              |
| b.    | (v.s.)       |
| c.    | *            |
| d.    | *            |
| e.   | *            |
| f.  |              |
| g.  |              |
| h.  |              |
| i.  | (v.s.)       |
| j.  | (v.s.)       |
| k.  |              |

The candidates considered next reveal two further properties of agreement constraints. Candidate (f) has spreading of [g] rather than [f]. This candidate does not violate  $\text{AGREE}([f],g)$ , because only one root node is linked to [f] and that node is associated with some [g]. However, if we compare candidate (f) with candidate (k) without spreading, we see that they do not differ in terms of  $\text{AGREE}([f],g)$ , which means that this constraint alone cannot enforce spreading of [g]. Candidate (g) contains a transparent root node. The constraint  $\text{AGREE}([f],g)$  is not violated by this candidate, because it refers only to full association, but not d-association between a feature and a transparent segment. The initial and final root nodes are both associated with [f] and some [g], satisfying  $\text{AGREE}([f],g)$ . Candidate (g) also demonstrates that the new agreement constraint is very different from the old one. Crucially, adjacency has no bearing in the new agreement constraint, which can be violated by strictly adjacent or non-adjacent root nodes.

Finally, candidates (h–k) have no spreading. Regardless of whether the segment fully associated with [f] is also fully associated with [g] or not, these candidates all satisfy the constraint  $\text{AGREE}([f],g)$ . At first, this seems a bit counterintuitive. In particular, what we see here is that  $\text{AGREE}([f],g)$  can only be violated by candidates with spreading. Furthermore, the faithfulness constraint  $\text{DEPLINK}[f]$  prefers no spreading, regardless of its ranking. However, we already have a constraint that prefers spreading—alignment. A combination of an alignment constraint and a higher ranked agreement constraint prefers spreading of [f] only if the target agrees with the trigger with respect to [g]. In addition, assimilation is restricted to a domain of the alignment constraint. This is exactly what is required in an analysis of Yowlumne, in which rounding spreads to the vowel which agrees with the trigger in vowel height. The following section gives an account of parasitic harmony in Yowlumne, which demonstrates that agreement and alignment work hand in hand.

### 8.3 Yowlumne

Recall section 8.1 which outlined the scope of Yowlumne parasitic rounding harmony. I attempted to account for the data using previously established constraints. These include alignment constraints, faithfulness constraints and feature co-occurrence constraints. No combination of these constraints can capture the Yowlumne parasitic harmony. In response to this challenge, I introduced another class of constraints in section 8.2. I base this new class of constraints on a widely used  $\text{AGREE}[f]$ . Classic agreement constraints may be modified to fit the current representational approach. I have demonstrated that such a solution has several advantages. First, the new agreement constraints dispense with the concept of adjacency. Adjacency in the definition of the constraint is entirely left out. Second,

the new template fleshes out the fact that reference to two features is required. Both modifications significantly shift the effect of agreement constraints, which can no longer enforce feature spreading on their own. Instead they can block spreading of one feature when the trigger and the target (or two targets) are dissimilar with respect to another feature. I now demonstrate this effect on Yowlumne.

The Yowlumne dialect of Yokuts is likely the most widely discussed case of parasitic vowel harmony.<sup>1</sup> As we have seen in section 8.1, Yowlumne has rounding harmony which targets {i, a}, which turn into {u, o}. However, rounding is found only when the trigger and the target (or two neighboring targets) agree in vowel height. More data is provided in (241). These data reveal that round vowels are only followed by round vowels of the same height. This applies rightwards and iteratively (cf. [tʰitʰtʰ-ijin] ‘raccoon’ ~ [tukʰ-ujun] ‘jackrabbit’). Some suffixes are underlyingly rounded themselves (cf. [tʰaw-hatin-xoo-hin] ‘was trying to win’).

(241) Yowlumne parasitic rounding harmony (Newman 1944:25,104,114,122, 134,135,137,138,145,151; Kuroda 1967:10,14)

- a. /-hin/ ‘AORIST’
- | HIGH VOWEL |             | OPEN VOWEL |                          |
|------------|-------------|------------|--------------------------|
| gijʰ-hin   | ‘touch’     | xat-hin    | ‘eat’                    |
| ʃilʰ-hin   | ‘see’       | caw-hin    | ‘shout’                  |
| baʃʰin-hin | ‘fall down’ | panaa-hin  | ‘arrive’                 |
| duj-hun    | ‘sting’     | ʔagaj-hin  | ‘pull’                   |
| muʃ-hun    | ‘swear’     | gop-hin    | ‘take care of an infant’ |
| ʔugun-hun  | ‘drink’     | hogin-hin  | ‘float’                  |
- b. /-taw/ ‘NON-DIRECTIVE GERUND’
- | HIGH VOWEL |          | OPEN VOWEL |                          |
|------------|----------|------------|--------------------------|
| gijʰ-taw   | ‘touch’  | xat-taw    | ‘eat’                    |
| ʔilik-taw  | ‘sing’   | panaa-taw  | ‘arrive’                 |
| muʃ-taw    | ‘swear’  | gop-tow    | ‘take care of an infant’ |
| hubuʃ-taw  | ‘choose’ | hojoo-tow  | ‘name’                   |
- c. /-hatin/ ‘OPTATIVE’
- | HIGH VOWEL      |              | OPEN VOWEL         |        |
|-----------------|--------------|--------------------|--------|
| bint-atin-xo-kʰ | ‘ask’        | tʰaw-hatin-xoo-hin | ‘win’  |
| hud-hatin-xo-ʔ  | ‘know about’ | dos-hotin-xoo-hin  | ‘tell’ |

<sup>1</sup>The original data come from Newman (1944). Subsequent treatments include Kuroda 1967; Kisseberth 1969; Gamble 1978; Jensen & Stong-Jensen 1979; Archangeli 1984, 1985, 1988; Archangeli & Pulleyblank 1994; Noske 1985; Steriade 1986; Cole 1987; Cole & Trigo 1988; Zoll 1993; Goldsmith 1993; Noske 1993; Kaun 1995; Sprouse 1997; Archangeli & Suzuki 1997b; McCarthy 1999, 2007b; Orgun & Sprouse 2007; Dresher 2009.

To summarize, any round vowels can serve as a trigger, but spreading applies only when the trigger and the target agree in vowel height. That is, high vowels round only other high vowels. Conversely, non-high vowels round only other non-high vowels.

The alternations found in Yowlumne can be characterized as spreading of the [round] feature. In the current context, feature spreading is driven by an alignment constraint which outranks the relevant faithfulness constraint. The alignment constraint contains three variables: a spreading feature, a targeted structure and a domain. The domain is a prosodic word and the spreading feature is [round]. The remaining question concerns the targeted structure. Three such structures are immediately available: the features [high], [open] and vowels. As established in section 3.2.3, [open] is a feature common to all non-high vowels.

One option is to say that an analysis of Yowlumne requires several different targeted structures and hence several different alignment constraints. In particular, one of these constraints has [high] as the targeted structure (as rounding spreads from high vowels only to high vowels), while the other has [open] as the targeted structure (as rounding spreads from non-high vowels only to non-high vowels). However, this approach is problematic for several reasons. First, the targeted structure is determined indirectly by transparent segments (172). When only one alignment constraint is ranked above  $\text{DEPLINK}[f]$ , the set of segments containing the targeted structure of the alignment constraint is the complement of the set of transparent segments. In Yowlumne, vowels generally cannot be skipped by rounding harmony, while consonants are skipped. This suggests that the targeted structure has to be a vowel. Second, having two different alignment constraints that have disjunctive sets of segments containing the targeted structure makes undesirable typological predictions, which is what I am trying to avoid in the first place. Put differently, the cross-linguistic differences in locality give evidence for what kind of targeted structures come with a specific spreading feature. If there is a constraint like  $*\omega([\text{round}], \text{open})$  there could be no constraint  $*\omega([\text{round}], \text{high})$ , or vice versa. I will further argue for  $*\omega([\text{round}], \text{open})$  and against  $*\omega([\text{round}], \text{high})$  in section 8.4.5.

The remaining option is that the relevant alignment constraint in Yowlumne has a vowel as the targeted structure. The constraint  $*\omega([\text{round}], \text{vowel})$  outranks the faithfulness constraint  $\text{DEPLINK}[\text{round}]$ . These two constraints are obviously not enough, since this ranking predicts spreading to all vowels—as we have seen in (232). Our aim here is to capture the pattern in which rounding applies only if the vowels agree in vowel height. The general template in (239) can be easily extended to fit this generalization. Agreement constraints have two variables: the spreading feature and the targeted structure. The spreading feature in this context is [round], while the targeted structure is a vowel height feature. Either [high] or [open] would

do the job. I choose the latter, as in (242). I will contrast  $\text{AGREE}([\text{round}], \text{open})$  with  $\text{AGREE}([\text{round}], \text{high})$  in section 8.4.6.

(242)  $\text{AGREE}([\text{round}], \text{open})$

A root node is fully associated with [round] and [open] iff all root nodes fully associated with that [round] are also fully associated with some [open].

The constraint  $\text{AGREE}([\text{round}], \text{open})$  has a clear blocking effect. It blocks spreading if the trigger and target do not match with respect to vowel height. In contrast, candidates without spreading always satisfy the constraint. This is because no root node can be both fully associated and not fully associated with any single autosegment. The agreement constraint outranks the other two constraints. I now move on to demonstrate the effect of this ranking on three Yowlumne inputs.

Tableau (243) contains an input with a combination of a round high root vowel followed by a high suffix vowel. In this case, candidate (b) with spreading wins over the faithful candidate (a). Neither of the candidates violates  $\text{AGREE}([\text{round}], \text{open})$ . As we have seen above, this agreement constraint can be violated only by a root node that is associated with both [round] and [open]. There is no such root node in any of the candidates, and the constraint is vacuously satisfied. Hence, candidate (b) wins because it satisfies the next highest ranked constraint,  $*\omega([\text{round}], \text{vowel})$ .

(243) muṭ'hun 'swear.AORIST'

|                                                                                        | $\begin{array}{c} [r] \\   \\ / m \ u \ t' - h \ i \ n / \\   \quad   \\ [h] \quad [h] \end{array}$                 |                                        |                                    |                           |
|----------------------------------------------------------------------------------------|---------------------------------------------------------------------------------------------------------------------|----------------------------------------|------------------------------------|---------------------------|
|                                                                                        |                                                                                                                     | $\text{AGREE}([\text{rd}], \text{op})$ | $*\omega([\text{rd}], \text{vow})$ | $\text{DEPLK}[\text{rd}]$ |
| a.                                                                                     | $\begin{array}{c} [r] \\   \\ m \ u \ t' \ h \ u \ n \\   \quad   \\ [h] \quad [h] \end{array}$                     |                                        | *!                                 |                           |
| b.  | $\begin{array}{c} [R] \\   \\ r \\   \\ r \\   \\ m \ u \ t' \ h \ u \ n \\   \quad   \\ [h] \quad [h] \end{array}$ |                                        |                                    | *                         |

We have now seen that agreement constraints are vacuously satisfied by any root node that is not fully associated by the spreading feature and the targeted struc-

ture. Since such outputs fare equally well in terms of the agreement constraint, the alignment constraint prefers spreading to all remaining high vowels.

Tableau (244) contains an input with two open vowels, one of which is round (244). Both candidates contain at least one root node that is fully associated with [open] and [round], yet neither of them violates the agreement constraint. Candidate (a) has no spreading. The first root node is linked to a [round] and [open]. However, because no other root node is linked to [round], the constraint is satisfied. Simply put, all root nodes that are fully associated with [round] are also fully associated with some [open]. This is also true for candidate (b), although [round] is linked to two root nodes (which are all both fully associated with [open]). The alignment constraint again decides between the two candidates, and candidate (b) with spreading wins.

(244) goptow ‘take care of an infant.NON-DIRECTIVE GERUNDIAL’

|                                                                                                                                                                                                                                                 |                |                       |           |
|-------------------------------------------------------------------------------------------------------------------------------------------------------------------------------------------------------------------------------------------------|----------------|-----------------------|-----------|
| $\begin{array}{c} [r] \\   \\ / g \ o \ p - t \ a \ w \ / \\   \quad   \\ [o] \quad [o] \end{array}$                                                                                                                                            | AGREE([rd],op) | * $\omega$ ([rd],vow) | DEPLK[rd] |
| <p>a.</p> $\begin{array}{c} [r] \\   \\ g \ o \ p \ t \ a \ w \\   \quad   \\ [o] \quad [o] \end{array}$                                                                                                                                        |                | *!                    |           |
| <p>b. </p> $\begin{array}{c} [R] \\ / \quad \backslash \\ r \quad r \\   \quad   \quad   \\ g \ o \ p \ t \ o \ w \\   \quad   \\ [o] \quad [o] \end{array}$ |                |                       | *         |

Recall that candidates without high vowels in (243) vacuously satisfy the agreement constraint. This slightly differs from candidates with open vowels in (244), which (non-vacuously) satisfy the agreement constraint. In both cases the alignment constraint decides among the candidates, preferring spreading.

The final input contains vowels of two different heights, one of which is round (245). Candidate (a) with no spreading does not violate the agreement constraint and wins. On the other hand, candidate (b) has [round] associated with two root nodes which disagree in vowel height. This configuration violates the agreement constraint.



(245) muṭ'taw 'swear.NON-DIRECTIVE GERUNDIAL'

| $\begin{array}{c} [r] \\   \\ / m \ u \ t' - t \ a \ w \ / \\   \quad   \\ [h] \quad [o] \end{array}$                                                      | AGREE([rd],op) | * $\omega$ ([rd],vow) | DEPLK[rd] |
|------------------------------------------------------------------------------------------------------------------------------------------------------------|----------------|-----------------------|-----------|
| a. $\rightarrow$ $\begin{array}{c} [r] \\   \\ m \ u \ t' \ t \ a \ w \\   \quad   \\ [h] \quad [o] \end{array}$                                           |                | *                     |           |
| b. $\begin{array}{c} [R] \\ / \quad \backslash \\   \quad   \\   \quad   \\   \quad   \\ m \ u \ t' \ t \ o \ w \\   \quad   \\ [h] \quad [o] \end{array}$ | *!             |                       | *         |

To summarize, an agreement constraint is violated under two conditions: (i) spreading of one feature applies and (ii) the trigger and one of the targets disagree in another feature. This suggests that the new agreement constraint inhibits rather than prefers spreading. The situation is consistent with an approach in which spreading is driven by alignment constraints. Put differently, the agreement constraint is effective in explaining the Yowlumne pattern solely in combination with an alignment constraint. In Yowlumne, spreading generally applies, as determined by the ranking of the alignment constraint \* $\omega$ ([round], vowel) above the faithfulness constraint DEPLINK[round]. However, spreading fails to apply when the trigger and the target are of different vowel heights. This is a specific case in which the dominant agreement constraint AGREE([round],open) becomes overtly active.

Such an analysis indicates that parasitic assimilation can be characterized in slightly different terms. Parasitic assimilation is like regular assimilation, except that it is blocked when the trigger and the target disagree in the targeted structure. In other words, certain combinations of triggers and targets are prohibited. This empirical generalization is captured by agreement constraints, which posit a condition on similarity of triggers and targets. The similarity between triggers and targets can be stated in terms of another feature.

Alignment constraints do not make any reference to the trigger. We have seen their effect in many cases so far. Some of these include consonant-vowel interactions, in which case triggers and targets are radically different. More specifically, the targeted structure of the alignment constraint determines the set of targets within a domain, but remains agnostic about triggers. Agreement constraints on

the other hand, do have this ability and inhibit spreading from some triggers to some targets. Furthermore, feature co-occurrence constraints cannot exclude any segment from the set of targets by making them transparent. Instead, they block spreading to all subsequent segments if they are ranked highest. Constraints on heads block spreading from underlying segments that have the spreading feature. I will demonstrate different rankings of these four types of constraints in rounding (section 8.4) and consonant harmony (section 8.5).

## 8.4 Rounding harmony

In this section, I extend the agreement approach demonstrated on Yowlumne to other languages with rounding harmony. I focus on the interaction of rounding harmony with vowel height. I begin by reviewing the typology of rounding harmony (section 8.4.1). As we will see, languages exhibit different degrees of restrictions on combinations of triggers and targets. I then move on to an analysis of five languages. As an example of unrestricted rounding harmony, I analyze Kyrgyz (section 8.4.2). The remaining languages (sections 8.4.3–8.4.6) all exhibit various degrees of restrictions of rounding harmony depending on vowel height.

### 8.4.1 Cross-linguistic generalizations

Rounding harmony is a fairly well-studied case of assimilation (Korn 1969; Odden 1991; Kaun 1995, 2004). In this section, I look at the interaction of rounding harmony with vowel height. In particular, rounding harmony is often times dependent on height of the trigger and/or the target vowel. For example, in some languages only high vowels trigger harmony, while in others only non-high vowels do. The interaction of rounding with vowel height serves as a case study, which is representative of a larger class of interacting vocalic features. These include interactions of rounding and backness, vowel height and backness (both are found in Finnish in section 5.5), tongue root and vowel height (see section 3.2) or tongue root and backness (Archangeli & Pulleyblank 1994).

The basic typology of rounding harmony with respect to vowel height according to Kaun (1995) is summarized in Table 8.1. There are six different types of languages. Some languages show no restrictions on rounding and height: all round vowels trigger harmony and all unrounded vowels are targets (type 1). Other languages have different restrictions on what segments are triggers or targets.

These restrictions, however, are not random. First, while type 2 languages show no restrictions on triggers, targets may be restricted such that only high vowels are targeted (such as in Turkish). According to Kaun (1995), there is no Anti-Turkish in which only open, but not high, vowels are targeted. Second, languages

| TYPE | TRIGGER | TARGET | EXAMPLE LANGUAGE (TOTAL) |
|------|---------|--------|--------------------------|
| 1    | any     | any    | Kyrgyz (2)               |
| 2    | any     | high   | Turkish (7)              |
| 3    | high    | high   | Kachin Khakass (3)       |
| 4    | open    | open   | Khalkha Mongolian (8)    |
| 5    | high    | high   | Yowlumne (1)             |
|      | open    | open   |                          |
| 6    | high    | high   | Yakut (2)                |
|      | open    | any    |                          |

Table 8.1: Triggers and targets in rounding harmony (Kaun 1995:69, 2004:88)

in which only one type of segments triggers rounding (types 3 and 4) will always be purely parasitic: their targets will need to be of the same height. Kaun (1995) reports no languages in which high vowels trigger rounding and target only open vowels, or the reverse. Third, languages with parasitic rounding harmony where all vowels can act as triggers will prefer spreading to high vowels. In particular, Yakut exhibits rounding harmony from non-high vowels that targets all vowels, but high vowels only target other high vowels. There is no reported Anti-Yakut, which would allow rounding of any vowel by a high vowel, but only open vowels from an open vowel.

The gaps in trigger–target pairs lead Kaun (1995) to conclude that non-high vowels make better triggers than high vowels, and conversely that high vowels make better targets than non-high vowels. Both of these generalizations can be modeled using the current theory. On the one hand, failure to trigger spreading is attributed to constraints on feature heads (chapter 4) or Heads-of-Heads (chapter 7). On the other, failure to be targeted can be attributed to a variety of factors, including alignment constraints (chapters 2, 3, and 5), feature co-occurrence constraints (chapter 6) and agreement constraints (section 8.2). I will now look at these factors in more detail.

Let us look at failing triggers first. In Table 8.1, types 3–6 all have some restrictions on triggers. In the type 3 languages non-high vowels cannot be triggers, whereas in the type 4 languages high vowels cannot be triggers. This shows that while languages may exhibit restrictions on triggers, the restrictions are not universal. In the present approach, failing triggers are attributed to constraints on feature heads or Heads-of-Heads. These constraints may be ranked freely with respect to alignment constraints, predicting both failing high and non-high vowels.

This is true even though open vowels tend to be better triggers compared to high vowels, which seems to be the case in the type 6 languages.

The failure of some segments to undergo rounding is also common. In Table 8.1, all but the first type exhibit some restrictions on targets. In particular, types 2 and 6 show that high vowels are preferred targets even if the trigger is an open vowel. In the present approach, restrictions on targets are captured primarily by alignment constraints. More specifically, it is the targeted structure of an alignment constraint that determines what segments are targeted. In response to the apparent preference for high vowel targets, we could conclude that there are at least two types of possible targeted structures when the spreading feature of the alignment constraint is [round]. One would be [vowel], and the other would be [high], whereas [open] would not be a possible targeted structure. This way we predict a language with all vowels undergoing spreading or only high vowels, but no language with only open vowels undergoing spreading. However, such a solution is problematic for three reasons. First, some languages prefer spreading to open vowels only. Baiyinna Orochen involves such a pattern.

Second, the main principle behind the idea of targeted structures is a connection between transparent segments and targets. In the strictest of senses, only transparent segments give cues to what the targeted structure of the relevant alignment constraint is. In the discussion of Finnish backness harmony in section 5.5, we have seen that the set of segments containing at least one targeted structure (of alignment constraints that outrank  $\text{DEPLINK}[f]$ ) and the set of transparent segments are complements. This bears directly on rounding harmony patterns. Note that table 8.1 does not include any information about transparency in rounding harmony, although Kaun (1995) does consider transparency in her study. Rounding harmony generally skips consonants. Consonants are transparent and their complement is a set of all vowels. Hence, the vowel is a viable targeted structure of the alignment constraint containing [round] as the spreading feature. The remaining question is whether vowels can also be transparent as we have seen in the case of RTR spreading in section 3.2. It turns out that only some vowels can be transparent to rounding harmony. Given the fact that high vowels seem to be better targets than open vowels, we would expect that open, but not high, vowels could be transparent. However, this prediction is incorrect. Kaun (1995) notes that transparent open vowels imply transparent high vowels, but not vice versa. Hence, the preference to target high vowels is only an illusion, which cannot be attributed to alignment constraints. Instead, I will propose that preference for high vowel targets is due to feature co-occurrence constraints.

The third and final reason why high vowels are not the best targets for rounding harmony is the existence of patterns not reported by Kaun (1995). One such pattern is Icelandic u-umlaut. We have seen in section 4.3 that u-umlaut involves

rounding triggered by a high vowel that targets only an open vowel, but not a high vowel.<sup>2</sup> This suggests that Kaun's typology from Table 8.1 is deficient as it fails to include cases in which a trigger is a high vowel and a target is an open vowel. In other words, while high targets are more frequent in Turkic, Tungusic and Mongolian languages, other languages may exhibit different patterns, including a preference for non-high targets. Icelandic u-umlaut is one such pattern. Another such pattern is Hungarian rounding harmony, which is found only with some non-high vowel suffixes (cf. [ty:z-høz] 'to (a) fire' ~ [viz-hɛz] 'to water' ~ [hɛrɲo:-hoz] 'to (a) caterpillar', data from Siptár & Törkenczy 2000:72).<sup>3</sup>

We can then conclude that only high vowels are targeted in some rounding harmony cases, only open vowels are targeted in others, but transparent open vowels imply transparent high vowels (and never the opposite). As we have seen in chapters 3, 5 and 6, skipping of high vowels (but not open vowels) can be attributed to the fact that alignment constraints with [round] as the spreading feature allow [open], but not [high], as the targeted structure. The same approach accounts for cases of languages that spread only to non-high vowels. Spreading to high vowels, but not to open, vowels is attributed to feature co-occurrence constraints. Unlike alignment constraints, feature co-occurrence constraints can never be satisfied by transparent segments.

In the five remaining subsections, I look at each of the five types of rounding harmony and give an analysis, which incorporates faithfulness, alignment, agreement, feature head and feature co-occurrence constraints. In section 8.4.2, I analyze Kyrgyz, which shows spreading to all targets. This is attributed to the general alignment over faithfulness ranking. In section 8.4.3, I move to Turkish. I demonstrate that a preference for high vowel targets is due to feature co-occurrence constraints on round open vowels, which can occur underlyingly, but cannot result from rounding harmony. In section 8.4.4, I argue that rounding in Kachin

---

<sup>2</sup>The alternative would be to object to the Icelandic data (i) because it involves fronting in addition to rounding, and (ii) because it is a case of umlauting and not rounding harmony. The answer to the first concern is that rounding harmony is typically accompanied by front/back harmony. A target undergoing rounding also undergoes backing, as we have seen for Baiyinna Orochen (section 7.3) or Yowlumne (section 8.3). In the latter, [i] alternates with [u], which involves both rounding and backing. Hence, Icelandic is not radically different than the other cases of vowel harmony. The answer to the second concern is that it is practically impossible to distinguish vowel harmony from similar processes like umlaut and metaphony. I will address this concern at length in section 9.5.1.

<sup>3</sup>For a complete treatment of Hungarian vowel harmony, including rounding harmony, see Vago 1976, 1978, 1980a,b; Clements 1977; Phelps 1978; Jensen 1978, 1984; Vago 1980b; Anderson 1980a; Zonneveld 1980; Ringen 1975/1988, 1980, 1982, 1988a; Battistella 1982; Booij 1984; Goldsmith 1985; van der Hulst 1985; van der Hulst & Smith 1986; Farkas & Beddor 1987; Steriade 1987a; Kontra & Ringen 1987; Steriade 1995; Olsson 1992; Ringen & Kontra 1989; Ringen & Vago 1998; Polgárdi 1998/2006; Siptár & Törkenczy 2000; Morén 2006d.

Khakass is due to agreement constraints on rounding and vowel height and constraints on heads, which cannot be open vowels. In section 8.4.5, I contrast Kachin with Khalkha Mongolian, which involves only open vowels, while high vowels are transparent. The Khalkha pattern involves an agreement constraint ranked above an alignment constraint that targets only open vowels. In section 8.4.6, I address further restrictions on rounding found in Yakut.

### 8.4.2 Kyrgyz

Kyrgyz (Wurm 1949; Herbert & Poppe 1963; Johnson 1980; Comrie 1981; Kaun 1995) constitutes the most unrestricted case of rounding harmony in which all vowels are triggers and all vowels are targets. This can be attributed to an alignment constraint that targets all vowels and outranks the faithfulness constraint.

The Kyrgyz vowel inventory in (246) exhibits eight vowels. Each front vowel has a back counterpart. Each unrounded vowel has a round counterpart.

(246) Kyrgyz vowel inventory (Herbert & Poppe 1963:7; Comrie 1981:60)

|        |   |      |          |      |
|--------|---|------|----------|------|
|        |   | [rd] |          | [rd] |
| [high] | i | y    | ɯ        | u    |
| [open] | e | ø    | a        | o    |
|        |   |      | [ back ] |      |

Kyrgyz vowels alternate in rounding and backness, as shown in (247). More specifically, a back rounded vowel can only be followed by another back rounded vowel. Similarly, a front rounded vowel is followed by another front rounded vowel. In other words, suffixes have round vowels if and only if the root has them, too. The relevance of morphological constituents in this and similar patterns will be further addressed in section 9.5.

(247) Round and front/back harmony in Kyrgyz (Comrie 1981:61)

|       |           |          |
|-------|-----------|----------|
| if    | if-ten    | ‘work’   |
| et    | et-ten    | ‘meat’   |
| ʒul   | ʒul-dan   | ‘year’   |
| alma  | alma-dan  | ‘apple’  |
| yj    | yj-døn    | ‘house’  |
| køl   | køl-døn   | ‘lake’   |
| tuz   | tuz-don   | ‘salt’   |
| tokoj | tokoj-don | ‘forest’ |
| ‘NOM’ | ‘ABL’     |          |

The data in (248) show that suffixes are regular targets and propagate harmony. That is, a round suffix vowel is followed by other round suffix vowels, whereas an unrounded suffix vowel is followed by unrounded suffix vowels.

- (248) Multiple suffixes (Comrie 1981:60)
- |            |                 |           |               |
|------------|-----------------|-----------|---------------|
| ata-sun-da | ‘at his father’ | tuz-un-do | ‘in his salt’ |
| ene-sin-de | ‘at his mother’ | køz-yn-dø | ‘in his eye’  |

To summarize, Kyrgyz exhibits an apparently simple, symmetrical and unrestricted rounding harmony. A round vowel is always followed by another round vowel, regardless of vowel height. In the current approach, such patterns can be represented as feature spreading, which is enforced by ranking of an alignment constraint above a faithfulness constraint. In Kyrgyz, rounding spreads rightwards (from a root to suffixes) to all vowels, within a prosodic word. Hence, the alignment constraint is  $*\omega([\text{round}], \text{vowel})$ . This constraint outranks the faithfulness constraint  $\text{DEPLINK}[\text{round}]$ .

The effect of this rather simple ranking is shown in tableau (249). The faithful candidate (a) and candidate (b) with one target fatally violate the alignment constraint.

- (249)  $køzyndø$  ‘in his eye’

|                                                                                                           | $*\omega([\text{round}], \text{vowel})$ | $\text{DEPLINK}[\text{round}]$ |
|-----------------------------------------------------------------------------------------------------------|-----------------------------------------|--------------------------------|
| $\begin{array}{c} [r] \\   \\ / k \emptyset z - i n - d e / \end{array}$                                  |                                         |                                |
| a. $\begin{array}{c} [r] \\   \\ k \emptyset z i n d e \end{array}$                                       | *!*                                     |                                |
| b. $\begin{array}{c} [R] \\ / \quad \backslash \\   \quad   \\ k \emptyset z y n d e \end{array}$         | *!                                      | *                              |
| c. $\begin{array}{c} [R] \\ / \quad \backslash \\   \quad   \\ k \emptyset z y n d \emptyset \end{array}$ |                                         | **                             |

This concludes the analysis of Kyrgyz. We have seen that rounding spreads from and to all vowels, which is attributed to a simple ranking of an alignment constraint over a faithfulness constraint. The remaining languages all impose restrictions on what segments can be triggers or targets. These effects are attributed to other constraints which outrank the alignment constraint.

### 8.4.3 Turkish

Turkish is another well known case of rounding harmony (Lewis 1967; Underhill 1976; Crothers & Shibatani 1980; Clements & Sezer 1982; Kardestuncer 1982; Goldsmith 1990; Ringen 1975/1988; van der Hulst & van de Weijer 1991; Kirchner 1993; Walker 1993; Polgárdi 1999; Baković 2000; Padgett 2002b; Krämer 2003). The Turkish vowel system is identical to that of Kyrgyz. Furthermore, backness harmony in both languages is similar. The crucial difference is in rounding harmony. Unlike in Kyrgyz, only high vowels are targeted in Turkish. Since both languages have the same inventory, the restrictions on targets must be due to some other factor.

Turkish has eight vowels (250). Each front vowel has a back counterpart. Each unrounded vowel has a round counterpart.

(250) Turkish vowel inventory

|        |   |         |   |          |
|--------|---|---------|---|----------|
|        |   | [rd]    |   | [rd]     |
| [high] | i | y       | u | u        |
| [open] | e | ø       | a | o        |
|        |   | [front] |   | [ back ] |

Turkish has rounding and backness harmony (251). While the front/back alternations are an important fact of Turkish vowel harmony, they will not be considered here for two reasons. First, there are many languages exhibit backness harmony without rounding (e.g. Finnish in section 5.5). Second, the interaction of the rounding and backness harmony can be complex (see Kaun 1995 for further discussion). One way of accounting for these differences is to treat the two processes separately. This is directly relevant to the patterns found in the two languages under current discussion. Backness harmony in Turkish is identical to Kyrgyz: front root vowels are followed by front suffix vowels, whereas back root vowels are followed by back suffix vowels. Rounding harmony generalizations in Turkish differ from Kyrgyz. High vowels are subject to rounding harmony, as expected. For example, the genitive suffix in (251) contains a round vowel when preceded by a root containing a round vowel, but not otherwise. However, open vowels are not subject to rounding harmony. Unrounded open vowels never become round.



(251) Turkish vowel harmony (Clements & Sezer 1982:216)

|                   |                      |                        |                           |           |
|-------------------|----------------------|------------------------|---------------------------|-----------|
| ip                | ip-in                | ip-l̥er                | ip-l̥er-in                | ‘rope’    |
| e <sup>h</sup>    | e <sup>h</sup> -in   | e <sup>h</sup> -l̥er   | e <sup>h</sup> -l̥er-in   | ‘hand’    |
| kuuz              | kuuz-um              | kuuz-lar               | kuuz-lar-um               | ‘girl’    |
| sap               | sap-um               | sap-lar                | sap-lar-um                | ‘stalk’   |
| jyz               | jyz-yn               | jyz-l̥er               | jyz-l̥er-in               | ‘face’    |
| k <sup>h</sup> øj | k <sup>h</sup> øj-yn | k <sup>h</sup> øj-l̥er | k <sup>h</sup> øj-l̥er-in | ‘village’ |
| pul               | pul-un               | pul-lar                | pul-lar-um                | ‘stamp’   |
| son               | son-un               | son-lar                | son-lar-um                | ‘end’     |
| ‘NOM’             | ‘GEN’                | ‘NOM-PL’               | ‘GEN-PL’                  |           |

Some suffixes containing back round vowels {o, u} are always round and trigger rounding of the following suffixes, as displayed by the data in (252). Similar cases with front round vowels {y, ø} are not attested.

(252) Non-alternating suffixes (Kornfilt 1997:500, Clements & Sezer 1982:231)

|    |                                                     |                         |                                                      |                      |
|----|-----------------------------------------------------|-------------------------|------------------------------------------------------|----------------------|
| a. | g <sup>h</sup> e <sup>h</sup> -d̥i                  | ‘I came’                | g <sup>h</sup> e <sup>h</sup> -i <sup>h</sup> or-d̥u | ‘I was coming’       |
| b. | g <sup>h</sup> e <sup>h</sup> -i <sup>h</sup> or-um | ‘I am coming’           | gid-edur-sun                                         | ‘let him keep going’ |
|    | kof-adur-sun                                        | ‘let him keep running’  | kof- <u>u</u> or-um                                  | ‘I am running’       |
|    | gyl-edur-sun                                        | ‘let him keep laughing’ | gyl <sup>h</sup> -y <sup>h</sup> or-um               | ‘I am laughing’      |
|    | bak-adur-sun                                        | ‘let him keep looking’  | bak- <u>u</u> or-um                                  | ‘I am looking’       |

To summarize, rounding spreads from a an underlying round vowel to all following high, but not open, vowels. In response to these data, perhaps the most obvious solution would be to posit an alignment constraint that targets high vowels: \* $\omega$ ([round], high). However, this is highly undesirable because there are languages in which spreading to non-high vowels is preferred: Icelandic (section 4.3), Baiyinna Orochen (section 7.3), Hungarian (section 8.4.1), Khalkha Mongolian (section 8.4.5). In the current model, an alignment constraint with [round] as the spreading feature can only come with a small number of targeted structures. A vowel as the targeted structure is not problematic, but of the two height features—[high] and [open]—only one is a possible targeted structure. This follows from the basic assumptions of the present approach, which is that alignment constraints are in a stringency relation (section 3). The remaining issue is which of the two structures is actually required. I will show that the evidence is stronger for [open] than for [high]. This is because neither Turkish nor any other language with rounding harmony allows transparent open, but not high, vowels. An alignment constraint \* $\omega$ ([round], high) predicts such an unattested language. In the current model, the targeted structure is determined by transparent segments. Transparent segments are only consonants, the complement of which are all vowels. Hence, the targeted structure of the alignment constraint is a vowel rather than [high].

Therefore, a better solution for Turkish vowel harmony involves the vowel as the targeted structure. The alignment constraint  $*\omega([\text{round}], \text{vowel})$  outranks  $\text{DEPLINK}[\text{round}]$ , just as in Kyrgyz (249). This ranking, however, is not sufficient, since Turkish obviously differs from Kyrgyz. The difference is in the fact that open vowels are never targeted or skipped by spreading, which suggests that the feature co-occurrence constraint  $*[\text{round open}]$  outranks the alignment constraint  $*\omega([\text{round}], \text{vowel})$ . The problem with such a solution is that it excludes round open vowels altogether, yet they are possible in roots and some suffixes. The generalization seems to be that round open vowels can surface in roots and some suffixes, but can never be derived by assimilation. This strongly suggests that  $\text{MAXLINK}[\text{round}]$  outranks the feature co-occurrence constraint  $*[\text{round open}]$ . If so, underlying round vowels are protected by  $\text{MAXLINK}[\text{round}]$ , whereas derived ones are not, and the constraint  $*[\text{round open}]$  prefers blocking.

The effect of this ranking is shown in tableau (253). The faithful candidate (a) wins because it preserves input rounding (satisfying  $\text{MAXLINK}[\text{round}]$ ), but shows no further rounding, which does not incur any additional violations of  $*[\text{round open}]$ . Candidate (b) delinks  $[\text{round}]$ , which violates  $\text{MAXLINK}[\text{round}]$ , while candidates (c) and (d) have spreading to at least one vowel, resulting in additional  $*[\text{round open}]$  violations. Keep in mind that both targets and transparent segments violate this constraint. Backness harmony is not considered here, and needs a separate set of constraints.

(253) sonlarum 'end.GEN.PL'

|                 |                                                                                                         | MAXLINK[rd] | *[rd op] | * $\omega$ ([rd],vow) | DEPLK[rd] |
|-----------------|---------------------------------------------------------------------------------------------------------|-------------|----------|-----------------------|-----------|
|                 | $\begin{array}{c} [r] \\ / s \ \underset{[o]}{o} \ n - l \ \underset{[o]}{a} \ r - u \ m / \end{array}$ |             |          |                       |           |
| a. $\leftarrow$ | $\begin{array}{c} [r] \\ s \ \underset{[o]}{o} \ n \ l \ \underset{[o]}{a} \ r \ u \ m \end{array}$     |             | *        | **                    |           |
| b.              | $\begin{array}{c} s \ \underset{[o]}{a} \ n \ l \ \underset{[o]}{a} \ r \ u \ m \end{array}$            | *!          |          |                       |           |
| c.              | $\begin{array}{c} [R] \\ / r \ \underset{[o]}{o} \ n \ l \ \underset{[o]}{a} \ r \ u \ m \end{array}$   |             | **!      | *                     | *         |
| d.              | $\begin{array}{c} [R] \\ / r \ \underset{[o]}{o} \ n \ l \ \underset{[o]}{o} \ r \ u \ m \end{array}$   |             | **!      |                       | **        |

Tsableau (253) shows that spreading never targets open vowels. Tableau (254), on the other hand, shows that spreading from open vowels applies, even if they occur in suffixes. Three candidates are considered. Candidate (a) is faithful, candidate (b) shows delinking, while the winning candidate (c) shows spreading. Candidate (b) fatally violates MAXLINK[round], whereas candidate (a) fatally violates the alignment constraint.

(254) g<sup>j</sup>el<sup>j</sup>ijordu ‘come.PROG.PAST’

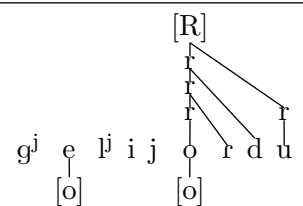
| / g <sup>j</sup> e l <sup>j</sup> - i j o <sup>[r]</sup> r - d u /<br>[o] [o]        | MAXLINK[rd] | *[rd op] | *ω([rd],vow) | DEPLK[rd] |
|--------------------------------------------------------------------------------------|-------------|----------|--------------|-----------|
| a. g <sup>j</sup> e l <sup>j</sup> i j o <sup>[r]</sup> r d u<br>[o] [o]             |             | *        | *!           |           |
| b. g <sup>j</sup> e l <sup>j</sup> i j a r d u<br>[o] [o]                            | *!          |          |              |           |
| c.  |             | *        |              | *         |

This approach captures Turkish rounding harmony. A necessary assumption in these cases is that the alternating suffixes are not round underlyingly, but this is entirely consistent with the fact that some Turkish suffixes alternate, while others do not.

Another way of accounting for the data are morpheme-specific constraints, which apply to some morphemes but not others (Itô & Mester 1995a,b, 1999, 2001, 2003, 2008a; Fukazawa et al. 1998; Pater 2000, 2007, 2009). In Turkish only some suffixes require specific, indexed constraints, but not others. I will not pursue this here, but what one can see is that in either approach no reference to [high] is necessary. More specifically, the alignment constraint that drives rounding never contains [high] as the targeted structure. The same conclusion can be extended to other languages with the Turkish-like pattern. Tuvan, for example, allows open round vowels only in root-initial syllables, but not elsewhere (Krueger 1977). This pattern can be attributed to a positional faithfulness constraint to root-initial syllables (Beckman 1997, 1998), which outranks the feature co-occurrence constraint against open round vowels. Positional faithfulness is discussed at length in chapter 9.

To recap, Turkish differs from Kyrgyz in that open vowels cannot be targets of rounding. I attribute this to the ranking of a feature co-occurrence constraint \*[round open] above the alignment constraint in Turkish, but not in Kyrgyz. Hence, the distinction between the two languages appears to be rather minimal, and not dependent on what the targeted structure of the alignment constraint is. More specifically, the Turkish data does not require the alignment constraint to target only high vowels.

### 8.4.4 Kachin Khakass

The Kachin dialect of Khakass (henceforth, Kachin; Korn 1969; Kaun 1995) exhibits even more restrictions on rounding in compared to Turkish and Yowlumne. Like Turkish, Kachin has eight vowels and only high vowels undergo rounding (and backness) harmony. Unlike Turkish, only high vowels, but not open vowels, trigger rounding. What makes Kachin similar to Yowlumne is that the trigger and the target agree in vowel height. What makes Kachin different is that open vowels are never triggers. In what follows, I will demonstrate that similar constraints are involved in these three languages. Different ranking of these constraints results in different surface patterns.

The Kachin vowel system consists of eight vowels and is identical to the inventory of Kyrgyz (246) or Turkish (250). These vowels alternate both in terms of rounding and backness. However, the alternations in Kachin are much more restricted. As we can see in (255), rounding applies only when both the trigger and the target are high vowels.

(255) Kachin Khakass vowel harmony (Korn 1969:102–103)<sup>4</sup>

| POTENTIAL TRIGGERS |               |          |                |    |         |
|--------------------|---------------|----------|----------------|----|---------|
| HIGH               |               | OPEN     |                |    |         |
| kyn-ny             | ‘day-ACC’     | ød-ir    | ‘to kill’      | HI | TARGETS |
| kuf-tuŋ            | ‘of the bird’ | ok-tuŋ   | ‘of the arrow’ |    |         |
| kyn-ge             | ‘to the day’  | tʃør-gen | ‘who went’     |    |         |
| kuzuk-ta           | ‘in the nut’  | pol-za   | ‘if he is’     |    |         |

The Kachin pattern can be seen as a composite of two separate restrictions. One is parasitism, namely that the trigger and the target must agree in vowel height. We have seen one such pattern in Yowlumne (section 8.3), in which rounding applies only when the trigger and the target agree in vowel height. The difference between Yowlumne and Kachin is in triggers. In Yowlumne both high and open vowels can be triggers. In contrast, open vowels cannot be triggers in Kachin. This is the second restriction. We have seen similar patterns in both icy targets (chapter 4) and failing triggers (chapter 7). In Icelandic, for example, [round] does not spread from open vowels, although it spreads from high vowels (section 4.3). The situation in Kachin is identical.

The two restrictions have separate mechanisms. Parasitic assimilation is attributed to agreement constraints. More specifically, the relevant agreement constraint refers to [round] and [open] (or alternatively, [high]). This constraint has

---

<sup>4</sup>The data from this language is extremely limited. The original source, Korn (1969), includes a detailed description of the vowel inventory and the distributions, but lists only nine (9) forms.

been used in connection to Yowlumne in (242), but I repeat it below in (256) for convenience. Agreement constraints do not contain a directional variable.

- (256) AGREE([round],open)  
 A root node is fully associated with [round] and [open] iff all root nodes fully associated with that [round] are also fully associated with some [open].

In Yowlumne, the agreement constraint outranks the alignment constraint  $*\omega$ ([rd],vow), which in turn outranks the faithfulness constraint DEP LINK[round]. I will take on this ranking and apply it to Kachin.

Restrictions on triggers, on the other hand, are attributed to constraints against heads. Because heads of [round] never surface on open vowels in Kachin, the relevant constraint penalizes the combination of [ROUND] and [open]. This constraint has been used in connection to Icelandic in (99), but I repeat it below in (257) for convenience. Constraints on heads do not contain a directional variable. In the Kachin data available, the effects of the constraint on feature heads are indistinguishable from the constraint on Heads-of-Heads  $*[\text{ROUND open}]$ , which would also be entirely sufficient. Keep in mind that constraints on heads are also violated by transparent segments, as we have seen in sections 5.2.2 and 5.3. This means that transparent open vowels are also ruled out by the constraint  $*[\text{ROUND open}]$ .

- (257)  $*[\text{ROUND open}]$   
 Assign a violation mark for every root node  $\times$ , iff  $\times$  is a Head of the feature [round] and  $\times$  is associated with [open].

Much like in Icelandic, the constraint on heads  $*[\text{ROUND open}]$  outranks the alignment constraint. The effect of these constraints will be shown in three steps.

I first consider an input with two high vowels, the first of which is round, as in (258). In this case, rounding applies and candidate (b) wins. This is due to the alignment constraint  $*\omega$ ([rd],vow), which is fatally violated by the faithful candidate (a). Both candidates vacuously satisfy the two highest ranked constraints, because neither contains an instance of [open].

(258) kynny ‘day.ACC’

| $\begin{array}{c} [r] \\   \\ / k \ y \ n - n \ i \ / \\   \quad   \\ [h] \quad [h] \end{array}$                  | AGREE([rd],op) | *[RD op] | * $\omega$ ([rd],vow) | DEPLK[rd] |
|-------------------------------------------------------------------------------------------------------------------|----------------|----------|-----------------------|-----------|
| a. $\begin{array}{c} [r] \\   \\ k \ y \ n \ n \ i \\   \quad   \\ [h] \quad [h] \end{array}$                     |                |          | *!                    |           |
| b. $\begin{array}{c} [R] \\   \\ r \\   \\ r \\   \\ k \ y \ n \ n \ y \\   \quad   \\ [h] \quad [h] \end{array}$ |                |          |                       | *         |

In (259), we see an input with one high and one open vowel, the first of which is round. In this case, the faithful candidate (a) wins, despite the fact it violates the alignment constraint. Candidate (b) with spreading, on the other hand, violates the agreement constraint, because both vowels are round but they do not have the same vowel height.

(259) kyn-ge ‘to the day’

| $\begin{array}{c} [r] \\   \\ / k \ y \ n - g \ e \ / \\   \quad   \\ [h] \quad [o] \end{array}$                  | AGREE([rd],op) | *[RD op] | * $\omega$ ([rd],vow) | DEPLK[rd] |
|-------------------------------------------------------------------------------------------------------------------|----------------|----------|-----------------------|-----------|
| a. $\begin{array}{c} [r] \\   \\ k \ y \ n \ g \ e \\   \quad   \\ [h] \quad [o] \end{array}$                     |                |          | *                     |           |
| b. $\begin{array}{c} [R] \\   \\ r \\   \\ r \\   \\ k \ y \ n \ g \ o \\   \quad   \\ [h] \quad [o] \end{array}$ | *!             |          |                       | *         |

Finally, we see an input with two open vowels, the first of which is round. In this case, too, the faithful candidate (a) wins. This is because the spreading candidate

(b) violates the constraint on feature heads \*[ROUND open], since it contains an open segment that is a feature head. Both candidates satisfy the agreement constraint, since [round] is fully associated only to open segments. This ranking can be extended to an input with a round open vowel followed by a high vowel, in which case the spreading candidate crucially violates both the agreement constraint and the constraint on heads.

(260) tʃørgen ‘who went’

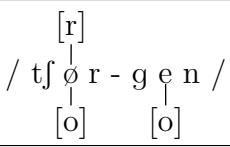
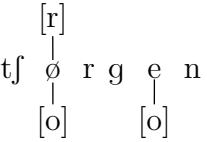
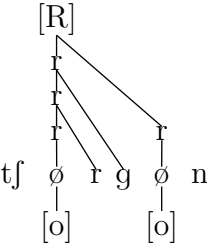
| <br>/ tʃ ø r - g e n / | AGREE([rd],op) | *[RD op] | *ω([rd],vow) | DEPLK[rd] |
|---------------------------------------------------------------------------------------------------------|----------------|----------|--------------|-----------|
| a.                     |                |          | *            |           |
| b.                    |                | *!       |              | *         |

We have now seen that Kachin displays an even more restricted case which is a combination of the parasitic rounding found in Yowlumne and the restrictions on triggers found in Icelandic. Like Yowlumne, spreading depends on the agreement in terms of vowel height between a trigger and a target. Like Icelandic, triggers cannot be open vowels and no open vowel can be transparent. Hence, only spreading from one high vowel to another is found, but not otherwise. The present approach based on faithfulness, alignment, agreement and feature-head constraint predicts this pattern perfectly. Furthermore, it allows for a straightforward and unified analysis of Kachin, Yowlumne and Icelandic rounding harmonies.

### 8.4.5 Khalkha Mongolian

The Khalkha dialect of Mongolian (henceforth, Khalkha; also known as Halh or Standard Mongolian as spoken in Ulaanbaatar) has rounding harmony, which is similar in its restrictions to Baiyinna Orochen and Kachin Khakass in some ways and similar to Yowlumne in other ways (Poppe 1951; Hamp 1958, 1980; Binnick 1969, 1980; Odden 1977, 1980, 1991; Jensen & Stong-Jensen 1979; Steriade 1979, 1987b, 1995; Anderson 1980b; Cohen 1981; Yamada 1983; Goldsmith 1985;



Svantesson 1985; Schein & Steriade 1986; van der Hulst & Smith 1987; Lieber 1987; Anderson & Ewen 1987; Demirdache 1988; Walker 1993; Kaun 1995; Svantesson et al. 2005; Drescher 2009). In section 7.3, we have seen that in Baiyinna only open vowels trigger rounding of other open vowels, but no high vowels can be skipped. The surprising fact about Khalkha is that it has a transparent [i]. I follow the approach to transparency developed in chapters 3, 5, 6 and argue that in Khalkha the alignment constraint has [open] as the targeted structure. Constraints on heads and an alignment constraint with a vowel as the targeted structure are not active in Khalkha.

Khalkha has seven vowels (261). Unlike in Kyrgyz and Turkish, there are no front round and back unrounded vowels. In addition, there is a tongue root distinction in both vowel heights (with the exception of high front vowels).

(261) Khalkha vowel inventory (Svantesson et al. 2005:22)

|       |   |      |        |
|-------|---|------|--------|
|       |   | [rd] |        |
| [atr] | i | u    | [high] |
|       |   | ʊ    |        |
| [atr] | e | o    | [open] |
|       | a | ɔ    |        |

Khalkha vowels alternate in rounding, backness, tongue root position (262). Here I focus on rounding harmony, which is triggered by open, but not high, round vowels.

(262) Khalkha vowel harmony (Svantesson et al. 2005:50,51)

|                      |          |            |               |
|----------------------|----------|------------|---------------|
| piir-e               | ‘brush’  | it-ʒe      | ‘to eat’      |
| suuʒ-e               | ‘tail’   | uc-ʒe      | ‘to see’      |
| mʊʊr-a               | ‘cat’    | xʊnʲ-ʒa    | ‘to pleat’    |
| teeʒ-e               | ‘grown’  | xeeʒ-ʒe    | ‘to decorate’ |
| c <sup>h</sup> aas-a | ‘paper’  | jaw-ʒa     | ‘to go’       |
| poor-ʊ               | ‘kidney’ | og-ʒʊ      | ‘to give’     |
| xʊʒ-ʊ                | ‘food’   | ʊr-ʒʊ      | ‘to enter’    |
| ‘REFL’               |          | ‘DIR.PAST’ |               |

Only non-high vowels are targeted. High vowels never show alternations. Front vowels are transparent, as shown in (263-a). Back rounded vowels never trigger spreading and block spreading, as shown in (263-b).

(263) Khalkha high vowels (Svantesson et al. 2005:50,51)

- a. [i] is transparent
- |                      |                         |          |
|----------------------|-------------------------|----------|
| piir-e               | piir-ig-e               | ‘brush’  |
| suuḷ-e               | suuḷ-ig-e               | ‘tail’   |
| mʊʊr-a               | mʊʊr-ig-a               | ‘cat’    |
| teeḷ-e               | teeḷ-ig-e               | ‘grown’  |
| c <sup>h</sup> aas-a | c <sup>h</sup> aas-ig-a | ‘paper’  |
| poor-᠔               | poor-ig-᠔               | ‘kidney’ |
| x᠔᠔ḷ-᠔               | x᠔᠔ḷ-ig-᠔               | ‘food’   |
| ‘REFL’               | ‘ACC-REFL’              |          |
- b. [u] blocks and fails to trigger rounding
- |                      |                         |               |
|----------------------|-------------------------|---------------|
| it-ḷe                | it-uḷ-ḷe                | ‘to eat’      |
| uc-ḷe                | uc-uḷ-ḷe                | ‘to see’      |
| xʊn <sup>j</sup> -ḷa | xʊn <sup>j</sup> -uḷ-ḷa | ‘to pleat’    |
| xeeḷ-ḷe              | xeeḷ-uḷ-ḷe              | ‘to decorate’ |
| jaw-ḷa               | jaw-uḷ-ḷa               | ‘to go’       |
| og-ḷ᠔                | og-uḷ-ḷe                | ‘to give’     |
| ɔr-ḷ᠔                | ɔr-uḷ-ḷa                | ‘to enter’    |
| ‘D.PST’              | ‘CAUS-D.PST’            |               |

To summarize, Khalkha has restrictions on triggers and targets. High vowels never trigger spreading. This is the opposite situation from what we have seen in Icelandic and Kachin, where only high vowels act as triggers. Furthermore, high front vowels are transparent in Khalkha. This differs from all previously discussed cases of rounding harmony. First, Baiyinna high vowels are always blockers, even if they are not rounded themselves. Second, Turkish and Kachin open vowels are never transparent. In fact, transparent vowels in rounding harmony are rather rare cross-linguistically. Two other known cases are Meadow Mari and Buriat Mongolian. The case of Meadow Mari is similar to c’Lela in that rounding targets a vowel only if it is absolutely word-final, but only schwa is transparent to this process (see section 5.4 for further discussion). Buriat (Poppe 1960; Kaun 1995; Svantesson 1985; Svantesson et al. 2005; Drescher 2009) has rounding harmony similar to Khalkha, yet in addition to the high front vowel, short [e] is also transparent.

In this thesis, transparency is generally attributed to the targeted structure of alignment constraints. In Mari, the constraint is distance insensitive (just as in c’Lela) and we predict that any segment could generally be transparent. In Buriat, on the other hand, transparency is due to the fact that there are two alignment constraints with [round] as the spreading feature. One targets long open vowels, while the other targets back vowels. We have seen a similar effect of two alignment constraints in Finnish (section 5.5). The Buriat case is complicated by the fact

that there is a distinction between long and short vowels. (This prosodic condition needs a separate explanation.)

In chapters 5 and 6 I present two main arguments why transparency needs an account that is independent of blocking. The first argument relies on the typological differences between transparency and blocking. For example, transparency in nasal harmony is limited to obstruents. In contrast, blocking is less restricted. Glides, liquids, and obstruents can be blockers.

The second argument comes from contrast. In particular, transparency is independent of the fact that some languages lack contrast on a particular segment, which is what most frameworks assume. Finnish, for example, has four front non-low vowels {i, e, y, œ}, but only two back non-low vowels {u, o}. Hence, we expect that the front round vowels {y, œ} will alternate with the back round vowels {u, o}. At the same time, the front unrounded vowels {i, e} will be transparent to backness harmony, since back unrounded {ʉ, ɤ} are absent from the inventory. However, I argue that this is only accidental. This is supported by the fact that some languages have transparent segments even though they have the corresponding contrast. For example, c'Lela lowering harmony targets only the final vowel, whereas it skips all intermediate (potential and identical) targets—as seen in section 5.4. Khalkha Mongolian is similar: [i] is transparent even though its rounded counterpart [u] is perfectly well-formed in the language. We can conclude that contrast may play an important role in transparency, but it is not adequate to explain all cases of transparency.

The solution I am proposing in this thesis is that the restricted transparency can be attributed to alignment constraints (whereas blocking is due to feature co-occurrence constraints). In particular, the implicational relationship between transparent segments can be captured by restricting possible combinations of a spreading feature and its targeted structures. When the spreading feature is [round], the targeted structures can be a vowel or [open], but not [high]. If the targeted structure is [open], all segments not containing this feature will be transparent. This means that all consonants and high vowels will be transparent, which is an attested pattern in Khalkha. An alignment constraint with [round] as the spreading feature and [high] as the targeted structure, on the other hand, predicts transparent consonants and open vowels, which is not attested (Kaun 1995). This gap is attributed to the absence of such a constraint.

In Khalkha, the alignment constraint involves [round] as the spreading feature, [open] as the targeted structure, and a prosodic word as the domain (Svantesson et al. 2005:52). Spreading is progressive, which means that [round] must not precede [open]. The alignment constraint \* $\omega$ ([round], open)—see (152)—outranks the faithfulness constraint DEPLINK[round].

This ranking will result in high vowels (and all consonants) being transparent, as shown in (264). Candidate (d) with a transparent high vowel wins, despite violating DEPLINK[round]. Candidate (a) with no spreading fatally violates alignment, while delinking input [round] as in candidate (b) fatally violates the high ranked MAXLINK[round]. Candidate (c) shows spreading only to the high vowel. Alignment constraints prefer rounding of open vowels to high vowels. This is why candidate (c) is harmonically bounded by the winning candidate (d). Candidate (e) has spreading to high vowels, which incurs an additional and fatal violation of DEPLINK[round]. Observe that the alignment constraint \* $\omega$ ([round], vowel) must be ranked below DEPLINK[round], which resembles the situation in Wolof [rtr] spreading (51).

(264) poorigo ‘kidney.ACC.REFL’

|                                                                                        |                                                                                                                                                                    | MAXLK[rd] | * $\omega$ ([rd],op) | DEPLK[rd] | * $\omega$ ([rd],vow) |
|----------------------------------------------------------------------------------------|--------------------------------------------------------------------------------------------------------------------------------------------------------------------|-----------|----------------------|-----------|-----------------------|
|                                                                                        | $\begin{array}{c} [r] \\   \\ p \text{ oo } r - i \text{ g} - e / \\   \quad   \quad   \\ [o] \quad [h] \quad [o] \end{array}$                                     |           |                      |           |                       |
| a.                                                                                     | $\begin{array}{c} [r] \\   \\ p \text{ oo } r \quad i \quad g \quad e \\   \quad   \quad   \\ [o] \quad [h] \quad [o] \end{array}$                                 |           | *!                   |           | **                    |
| b.                                                                                     | $\begin{array}{c} p \text{ ee } r \quad i \quad g \quad e \\   \quad   \quad   \\ [o] \quad [h] \quad [o] \end{array}$                                             | *!        |                      |           |                       |
| c.                                                                                     | $\begin{array}{c} [R] \\   \quad   \quad   \\ p \text{ oo } r \quad i \quad g \quad e \\   \quad   \quad   \\ [o] \quad [h] \quad [o] \end{array}$                 |           | *!                   | *         | *                     |
| d.  | $\begin{array}{c} [R] \\   \quad   \quad   \quad   \\ p \text{ oo } r \quad i \quad g \quad o \\   \quad   \quad   \quad   \\ [o] \quad [h] \quad [o] \end{array}$ |           |                      | *         | *                     |
| e.                                                                                     | $\begin{array}{c} [R] \\   \quad   \quad   \quad   \\ p \text{ oo } r \quad u \quad g \quad o \\   \quad   \quad   \quad   \\ [o] \quad [h] \quad [o] \end{array}$ |           |                      | **!       |                       |

Another fact about Khalkha is that input high round vowels never trigger rounding. One way to account for failing triggers is by constraints on feature heads. In Kachin, for example, \*[ROUND open] prevents spreading from open vowels (259). Parallel to this, the active constraint in Khalkha could be \*[ROUND high], which prevents spreading from high vowels. However, Khalkha is markedly different from Kachin in that (unrounded) high vowels are transparent. Recall sections 5.2.2, 5.3 and the fact that transparent segments also violate \*[ROUND high] when non-final. Put differently, constraints on heads never prefer transparency over targets. We have seen this effect in Icelandic (section 5.3), in which a constraint on heads prefers the target closest to the trigger, such that no transparent open vowels are created. Constraints on heads are not a viable solution for the Khalkha pattern, because they would rule out transparent high vowels, contrary to the data.

In this chapter, I introduced agreement constraints. These constraints prefer spreading to a subset of targets of lower ranked alignment constraints, as seen in Yowlumne and Kachin. In Khalkha, the alignment constraint prefers spreading to [open] vowels. In addition, spreading is triggered only by [open] vowels. In other words, both the trigger and the target must be [open]. This is exactly what agreement constraints were designed to do. Moreover, the agreement constraint in Khalkha is identical to the one used in Yowlumne and Kachin: AGREE([round], open). This constraint inhibits spreading when the trigger and the target have different vowel height.

Recall tableau (264) with an input containing an open trigger, followed by a high transparent vowel and an open target. While the winning candidate (c) satisfies the constraint AGREE([round], open), other constraints are sufficient to exclude all competing candidates. However, this is not the case when the trigger is a high round vowel. Such an input is presented in tableau (265). This tableau also includes a dominant AGREE([round], open). Five candidates are considered. Candidate (a) with no spreading wins, despite violating the alignment constraint \* $\omega$ ([round], open). Candidate (b) has delinking, which fatally violates MAXLINK[round]. Candidate (c) has spreading to a high vowel, which violates DEPLINK[round]. The alignment constraint \* $\omega$ ([round], open) remains violated by this candidate, since the final open vowel is not (fully) associated with [round]. Candidate (d) has spreading to the final vowel, which satisfies \* $\omega$ ([round], open). However, this situation fatally violates AGREE([round], open). This constraint is also fatally violated by the final candidate (e) with spreading to all vowels.

(265) suuḱige ‘tail.ACC.REFL’

|                                                                                                                                                                                                                                                         | MAXLK[rd] | AGREE<br>([rd],op) | * $\omega$ ([rd],op) | DEPLK[rd] | * $\omega$ ([rd],vow) |
|---------------------------------------------------------------------------------------------------------------------------------------------------------------------------------------------------------------------------------------------------------|-----------|--------------------|----------------------|-----------|-----------------------|
| $\begin{array}{cccc} & [r] & & \\ &   & & \\ / & s & uu & \mathfrak{K} - i & g - e & / \\ &   & &   & &   \\ & [h] & & [h] & & [o] \end{array}$                                                                                                         |           |                    |                      |           |                       |
| <p>a. <math>\rightarrow</math></p> $\begin{array}{cccc} & [r] & & \\ &   & & \\ s & uu & \mathfrak{K} & i & g & e \\ &   & &   & &   \\ & [h] & & [h] & & [o] \end{array}$                                                                              |           |                    | *                    |           | **                    |
| <p>b.</p> $\begin{array}{cccc} s & ii & \mathfrak{K} & i & g & e \\ &   & &   & &   \\ & [h] & & [h] & & [o] \end{array}$                                                                                                                               | *!        |                    |                      |           |                       |
| <p>c.</p> $\begin{array}{c} [R] \\   \\ r \\ / \quad \backslash \\ r \quad r \\   \quad   \\ s \quad uu \quad \mathfrak{K} \quad u \quad g \quad e \\   \quad   \quad   \quad   \quad   \\ [h] \quad [h] \quad [o] \end{array}$                         |           |                    | *                    | *!        | *                     |
| <p>d.</p> $\begin{array}{c} [R] \\   \\ r \\ / \quad   \quad \backslash \\ r \quad r \quad r \\   \quad   \quad   \\ s \quad uu \quad \mathfrak{K} \quad i \quad g \quad o \\   \quad   \quad   \quad   \quad   \\ [h] \quad [h] \quad [o] \end{array}$ |           | *!                 |                      | *         | *                     |
| <p>e.</p> $\begin{array}{c} [R] \\   \\ r \\ / \quad \backslash \\ r \quad R \\   \quad   \quad   \\ s \quad uu \quad \mathfrak{K} \quad u \quad g \quad o \\   \quad   \quad   \quad   \quad   \\ [h] \quad [h] \quad [o] \end{array}$                 |           | *!                 |                      | **        |                       |

Now compare the evaluations of the two alignment constraints: \* $\omega$ ([round], open) and \* $\omega$ ([round], vowel). In particular, \* $\omega$ ([round], vowel) is violated twice by the winning candidate (a), but only once by candidate (c). Candidates (a) and (c) do not differ in terms of any other constraint but DEPLINK[round] and \* $\omega$ ([round], vowel). When DEPLINK[round] outranks \* $\omega$ ([round], vowel), candidate (a) wins. If the ranking of the two constraints were reversed, candidate (c) would win instead. Yet this candidate is not the actual winner. This suggests that \* $\omega$ ([round], vowel) is correctly ranked below DEPLINK[round]. Instead, \* $\omega$ ([round], open) outranks DEPLINK[round]. In other words, the constraint \* $\omega$ ([round], open) is absolutely necessary and cannot be replaced by any other alignment constraint. This con-

straint also predicts transparent high, but not open, vowels, which matches the cross-linguistic generalizations. In rounding harmony, transparent open vowels imply transparent high vowels, but not vice versa.

In Khalkha, \* $\omega$ ([round], open) interacts with AGREE([round], open). The former constraint prefers spreading to open vowels (in combination with DEPLINK[rd]), whereas the latter penalizes outputs in which triggers and targets are not of the same height. Since targets are always [open] vowels, triggers also need to be [open]. When the trigger is a high vowel, alignment prefers spreading to open vowels, but agreement inhibits such spreading. When the trigger is an open vowel, alignment prefers spreading to other open vowels, whereas agreement does not inhibit such spreading; unrounded high vowels are transparent.

This concludes the analysis of Khalkha rounding harmony in which the high front vowel is transparent, while high round vowels do not trigger rounding. The process targets open vowels, which is attributed to an alignment constraint that has [open] as the targeted structure. This is unlike the situation in Turkish and Kachin, in which spreading never creates transparent open vowels. This gap can be attributed to the fact that the alignment constraints with [round] as the spreading feature can have [open], but not [high] as the targeted structure.

#### 8.4.6 Yakut

The final case of rounding harmony to be discussed is Yakut (Poppe 1959; Krueger 1962; Korkina et al. 1982; Kaun 1995; Anderson 1998), which has a limited type of parasitic vowel harmony. When the trigger is a high vowel, rounding is parasitic, and applies only to other high vowels. However, when the trigger is an open vowel, all vowels are targeted. I analyze this pattern by using a combination of a previously used agreement constraint in local conjunction with a constraint on feature heads.

The Yakut monophthong vowels are in (266). On the face of it, this inventory is identical to other Turkic languages seen so far, including Kyrgyz, Turkish, and Kachin. Most vowels distinguish long and short quantities, but this is not relevant to vowel harmony. Furthermore, the four diphthongs {ie̞, yø̞, ua̞, uo̞} contrast in rounding and backness but pattern phonologically with high vowels.

(266) Yakut monophthongs (without quantity; Poppe 1959:673; Krueger 1962:47; Korkina et al. 1982:41)

|        |   |         |   |          |
|--------|---|---------|---|----------|
|        |   | [rd]    |   | [rd]     |
| [high] | i | y       | u | u        |
| [open] | e | ø       | a | o        |
|        |   | [front] |   | [ back ] |

Yakut has both rounding and backness harmony. Here, I limit the discussion to rounding. The data in (267) reveal that harmony is determined by root vowels. Roots with unrounded vowels are followed by unrounded affix vowels *in all cases* (267-a). Roots with rounded vowels are followed by rounded affix vowels *in most cases* (267-b). There is one exception to this rule: a high vowel never spreads rounding to an open vowel (underlined). For example, ‘windows’ surfaces as [tynnyk-ter] and not as \*[tynnyk-tør] as it would if high vowels triggered rounding.

(267) Yakut vowel harmony (Krueger 1962:73,74,78,79,83-85,87,92)

a. Unrounded root V always followed by unrounded suffix V

POTENTIAL TRIGGERS

| HIGH      |             | OPEN       |                  |    |         |
|-----------|-------------|------------|------------------|----|---------|
| kihi-liin | ‘man-SOC’   | et-im      | ‘meat-my’        |    |         |
| tuj-u     | ‘foal-ACC’  | aya-nuu    | ‘father-ACC’     | HI | TARGETS |
| kini-ler  | ‘he-PL’     | et-ter     | ‘meat-PL’        | OP |         |
| tuj-da    | ‘foal-PART’ | paarta-lar | ‘school desk-PL’ | OP |         |

b. Round root V followed by rounded suffix V (unless underlined)

POTENTIAL TRIGGERS

| HIGH               |              | OPEN      |             |    |         |
|--------------------|--------------|-----------|-------------|----|---------|
| tynnyg-y           | ‘window-ACC’ | børø-lyyn | ‘wolf-SOC’  |    |         |
| murun-u            | ‘nose-ACC’   | oyo-luun  | ‘child-SOC’ | HI | TARGETS |
| tynnyk- <u>ter</u> | ‘window-PL’  | børø-ttøn | ‘wolf-ABL’  | OP |         |
| tobuk- <u>ka</u>   | ‘knee-DAT’   | son-ton   | ‘coat-ABL’  | OP |         |

There are several descriptive generalizations that can be made. First, suffixes cannot be rounded on their own. Instead, suffixes are round only if preceded by a round vowel. As I will show in chapter 9, this is due to a high ranked positional faithfulness constraint, which preserves underlying rounding in roots, but not in suffixes. Second, rounding is triggered by all round vowels, which suggests that the spreading feature is [round]. Third, high vowels only trigger rounding if the target is also a high vowel. In other words, all vowels are targeted, yet open vowels require an open trigger. This suggests that the active alignment constraint in Yakut targets all vowels—\* $\omega$ ([round],vowel). This alignment constraint outranks DEPLINK[round], because otherwise no spreading would have occurred.

The remaining question is how to capture the restriction on high vowel triggers. High vowels sometimes fail to trigger rounding, which indicates that the active constraint prohibits feature heads of [round] to be high vowels—\*[ROUND high]. However, this constraint can be violated when both the trigger and its targets are high vowels. Put differently, \*[ROUND high] can be violated when the agreement constraint AGREE([round],open) is satisfied. Conversely, the agree-



ment constraint can be violated if a trigger is an open vowel and the target is a high vowel, but not vice versa. This suggests that both \*[ROUND high] and AGREE([round],open) can be violated independently in Yakut. The former is violated whenever a high vowel spreads rounding to another high vowel. The latter is violated whenever an open vowel spreads rounding to a high vowel (or vice versa). What is not attested in Yakut is that the two constraints are violated by the same segment. In particular, if the trigger is a high vowel, then it must agree in height with the following target. This condition can be formalized in terms of Local Conjunction (LC), which has been previously introduced in section 4.6.1. LC of two constraints is violated only when both constraints are violated within a specified local domain. In the current example, the two constraints \*[ROUND high] and AGREE([round],high) are locally conjoined within the domain of a segment. In short, while attested forms violate both \*[ROUND high] and AGREE([round],high) independently, no attested outputs violate both constraints within the same segment, which would violate LC in (268). Note that I use AGREE([round],high) here in place of AGREE([round],open). There is a good reason for that. In most cases reviewed so far, the two agreement constraints have the same effect, because the domain of evaluation is larger than a segment. In Yakut, this is not the case. Whereas the constraint AGREE([round],open) is never violated by a high vowel, the constraint AGREE([round],high) may be. This suggests that the latter, but not the former, is required in an analysis of Yakut.

- (268)    \*[ROUND high]&<sub>seg</sub>AGREE([round],high)  
           Assign a violation mark iff \*[ROUND high] and AGREE([round],high) are  
           violated within the domain of a segment.

Before I proceed, I would like to address the question whether LC contradicts some of the restrictive predictions of this thesis. The relevant questions are whether LC of two alignment constraints are possible, or whether an agreement constraint could be in LC with an alignment constraint. As regards the later, LC of alignment and agreement never differs from the separate ranking of the two constraints. This is because alignment and agreement (at least when the same features and structures are involved) can never be violated at the same time. In particular, agreement can only be violated when a feature is associated with multiple vowels, in which case the alignment constraint is satisfied. Hence, such LCs are not necessary, and will not produce unattested patterns.

To make the question more general, we need to ask whether any LC of two alignment constraints predicts unattested patterns. The best way to find an answer to this question is to look at an example. Recall the typology of laxing harmony in section 3.2. I have shown that languages have laxing harmony that applies to all segments, only to vowels or only to open vowels. This descriptive gen-

eralization is captured by a restriction that alignment constraints containing [rtr] as the spreading feature can have only a subset of possible targeted structures. In particular, a root node, a vowel and [open] can serve as targeted structures when [rtr] is the spreading feature, whereas a consonant or [high] cannot. The main contribution of this thesis is in establishing such alignment constraint typologies. If LC could create such a pattern solely by joining two alignment constraints, that would be a strong motivation to abandon the approach altogether. I will show that LC cannot produce unattested patterns in most cases, while the remaining cases can be singled out and restricted in a principled way.

Consider an LC of two alignment constraints with the same spreading feature and two different targeted structures. The constraint  $*\omega(\text{vowel}, [\text{rtr}]) \&_{\text{seg}} * \omega(\text{open}, [\text{rtr}])$  is one such constraint. This constraint is only violated when open vowels f-precede [rtr], but not otherwise. In this sense, the effect of the two constraints is no different than the effect of  $*\omega(\text{open}, [\text{rtr}])$  alone. The same can be extended to other combinations. In no case can an LC of two independently required alignment constraints create an unattested pattern, such as the one involving spreading of [rtr] to high vowels from any segment, while skipping all other segments. The remaining question is what would happen if the alignment constraints had both different spreading features and targeted structures. Consider for example,  $*\omega(\text{vowel}, [\text{round}]) \&_{\text{seg}} * \omega(\text{high}, [\text{atr}])$ . This constraint would effectively spread either [round] and [atr], depending on the ranking of other constraints. No pattern requires such constraint, which suggests that the constraints in LC need to be restricted. The restriction I am proposing is that when the alignment constraints are in LC, the spreading features need to be identical—as in  $*\omega(\text{vowel}, [\text{rtr}]) \&_{\text{seg}} * \omega(\text{open}, [\text{rtr}])$ . Other alignment constraints cannot be conjoined, which excludes  $*\omega(\text{vowel}, [\text{round}]) \&_{\text{seg}} * \omega(\text{high}, [\text{atr}])$  and  $*\omega(\text{open}, [\text{round}]) \&_{\text{seg}} * \omega(\text{open}, [\text{front}])$  as possible constraints.

Now that the general issues of LC are resolved, I return to Yakut. Recall the locally conjoined constraint in (268), which outranks the alignment constraint  $*\omega([\text{round}], \text{vowel})$ , while both  $*[\text{ROUND high}]$  and  $\text{AGREE}([\text{round}], \text{high})$  are ranked below the alignment constraint. The effect of the total ranking is seen in inputs with high round vowels followed by open vowels, as in (269). Candidate (b) has spreading to more segments than candidate (a), which fatally violates the alignment constraint. Candidate (c) perfectly satisfies alignment, but fatally violates the high ranked LC. Only the high vowel in candidate (c) violates LC. The open vowel does not violate LC because it is neither a high vowel nor a head. Similarly, the high vowel in candidate (b) does not violate LC, because it is not a feature head of [round].

(269) tobukka ‘knee.DAT’

|                                                                                                                                                                                                                                                               |                                           |                     |               |
|---------------------------------------------------------------------------------------------------------------------------------------------------------------------------------------------------------------------------------------------------------------|-------------------------------------------|---------------------|---------------|
| $\begin{array}{c} [r] \\ / t \quad \underset{[o]}{o} \quad b \quad \underset{[h]}{u} \quad k - k \quad \underset{[o]}{a} / \\ [o] \quad [h] \quad [o] \end{array}$                                                                                            | $*[RD \ hi] \&_{seg}$<br>$AGREE([rd],hi)$ | $*\omega([rd],vow)$ | $DEPLINK[rd]$ |
| <p>a.</p> $\begin{array}{c} [r] \\ t \quad \underset{[o]}{o} \quad b \quad \underset{[h]}{u} \quad kk \quad \underset{[o]}{a} \\ [o] \quad [h] \quad [o] \end{array}$                                                                                         |                                           | $**!$               |               |
| <p>b. <math>\rightarrow</math></p> $\begin{array}{c} [R] \\ / \quad / \quad / \\ r \quad r \quad r \\   \quad   \quad   \\ t \quad \underset{[o]}{o} \quad b \quad \underset{[h]}{u} \quad kk \quad \underset{[o]}{a} \\ [o] \quad [h] \quad [o] \end{array}$ |                                           | $*$                 | $*$           |
| <p>c.</p> $\begin{array}{c} [R] \\ / \quad / \quad / \\ r \quad R \quad r \\   \quad   \quad   \\ t \quad \underset{[o]}{o} \quad b \quad \underset{[h]}{u} \quad kk \quad \underset{[o]}{o} \\ [o] \quad [h] \quad [o] \end{array}$                          | $u!$                                      |                     | $**$          |

We have now seen that only combinations of round high followed by open vowels violate the conjoined constraint in (268). The Yakut pattern can thus be explained in terms of local conjunction of a constraint on feature heads and an agreement constraint. This completes the analyses of different types of rounding harmony.

### 8.4.7 The larger picture

I have demonstrated that the present approach based on alignment constraints can successfully account for the attested patterns in rounding harmony. The particular analysis I am advancing is that the alignment constraint with [round] comes with at least two targeted structures: a vowel and [open]. Crucially, [high] cannot be the targeted structure, regardless of the fact that [high] is apparently preferred as a target. The cases preferring high targets are instead attributed to high ranked faithfulness and feature co-occurrence constraints (as in Turkish), agreement (as in Kachin) or local conjunction of agreement constraints and constraints on heads (as in Yakut). These analyses are consistent with the relationship between the targeted structure of alignment constraints and transparent segments. Transparent open vowels in rounding harmony imply transparent high vowels (but not vice versa). This effect cannot be attributed to feature co-occurrence constraints. More specifically, feature co-occurrence constraints are already employed to cap-

ture blocking. As we have seen in chapter 6, blocking patterns are quite different from transparency patterns.

The attested cases of rounding harmony also reveal two other effects: failing triggers and parasitic assimilation. In the present approach, the former is attributed to constraints on feature heads, while the latter is due to agreement constraints. Kachin displays both of these restrictions at the same time, while Yakut shows failing triggers only if agreement is violated, but not otherwise. By using a small set of constraints established independently for other assimilatory patterns, we were able to account for all types of rounding harmony.

In what follows, I extend the notion of parasitism to consonant harmony. In consonant harmony, spreading most times depends on similarity between triggers and targets. For example, sibilant harmony involves changes in anteriority that affect only coronal fricatives and affricates, but not other coronals. However, unlike rounding harmony, vowels and other consonants may be skipped in consonant harmony. I demonstrate that this skipping effect is predicted under the current approach. This is because the feature co-occurrence constraints (that prefer blocking by non-participating consonants) are ranked below alignment constraints.

## 8.5 Consonant harmony

In this section, I extend the agreement approach demonstrated on rounding harmony to another, seemingly unrelated assimilation pattern: consonant harmony. Consonant harmony is briefly defined as consonantal assimilation across vowels.

Consonant harmony is directly relevant to the current approach to feature spreading. Alignment constraints typically prefer spreading of a place feature to vowels. This predicts that a feature will either spread only to vowels (across intervening consonants) or a feature will spread to all segments. In section 3.2, I have demonstrated this for [rtr], which spreads to all segments, to vowels, or to open vowels, but it cannot spread from one consonant to another by skipping intervening vowels. This is captured by restricting the targeted structures of alignment constraints. This approach can generate vowel harmony, but not consonant harmony.

The second type of constraints that may drive spreading to a subset of segments are agreement constraints, which have been the focus of this chapter. I have already shown in sections 8.1–8.4 that agreement constraints force spreading to a subset of all targets of the alignment constraint. Effectively, agreement inhibits spreading of one feature if a trigger–target pair differs in some other feature. For example, Yowlumne rounding harmony is restricted in that the trigger and the target need to be of the same vowel height (241). In what follows, I demonstrate that the

particular restrictions in consonant harmony can also be attributed to agreement constraints.

This section is organized as follows. Section 8.5.1 provides a short cross-linguistic overview based on earlier studies. The three following sections present the three most common types of consonant harmony: sibilant harmony (8.5.2), retroflex harmony (8.5.3) and nasal consonant harmony (8.5.4). Finally, section 8.5.5 sets the consonant harmony patterns in the context of a more general theory of assimilation.

### 8.5.1 Cross-linguistic generalizations

Consonant harmony is assimilation limited to consonants: a consonant triggers the alternation of another consonant. What sets consonant harmony apart from other consonant–consonant assimilations is the fact that the trigger and the target can be separated by one or more vowels. Consonant harmony is a phenomenon that has been properly recognized in phonological theory only recently. While there are a few earlier studies that deal partly or exclusively with consonant harmony, larger typological studies have only been done within the last two decades (Shaw 1991; Odden 1994; Gafos 1996/1999; Hansson 2001; Rose & Walker 2004; Mackenzie 2009). These show that consonant harmony is not as rare as previously assumed, since at least some types of consonant harmony are rather frequent. For example, Hansson (2001) reports at least 31 languages with sibilant harmony. The number 31 is equivalent to 36% of known nasal harmony cases (86 in Walker 1998/2000) and nasal harmony is not considered rare. Table 8.2 presents a typological overview of consonant harmony.

The attested types of consonant harmony are quite restricted. First, most cases of consonant harmony are limited to static generalizations of distributions of consonants within morphemes (particularly roots). Whether these cases are to be regarded assimilation depends on a particular version of phonology. In the current context, assimilation requires an overt alternation, which involves a trigger and a target. Patterns within morphemes show clear alternations in a very limited set of cases. For instance, an independent (non-assimilatory) alternation can create a trigger which in turn affects another segment. In most cases, however, this type of data is not available. Some static patterns can be explained in the current model using alignment constraints, yet they can also be attributed to other devices in the form of morpheme structure constraints (see Gallagher & Coon 2009, Gallagher 2010a,b for a recent treatment). I remain agnostic about static patterns and focus primarily on active alternations (see section 8.5.3 for further discussion). The numbers in Table 8.2 refer to cases of consonant harmony which involve alternations and exclude all static patterns due to morpheme structure constraints.

| TYPE      | SUBTYPE           | SEGMENTS                | EX. LANGUAGE (NO.)       |
|-----------|-------------------|-------------------------|--------------------------|
| Coronal   | sibilant          | fricatives, affricates  | Aari (31)                |
|           | retroflex         | obstruents              | Sanskrit (4)             |
|           | dental            | stops, affricates       | Mayak (4)                |
| Dorsal    | RTR               | stops, obstruents       | Tlachichilco Tepehua (2) |
| Liquid    |                   | liquids                 | Basaa (6)                |
| Nasal     |                   | voiced stops, sonorants | Yaka (14)                |
| Secondary | palatalization    | consonants              | Karaim (2)               |
|           | pharyngealization | consonants              | Tsilhqot'in (1)          |
| Laryngeal |                   | stops                   | Berber (1)               |
| Stricture |                   | stops, fricatives       | Yabem (3)                |

Table 8.2: Types of consonant harmony with alternations (Hansson 2001; Rose & Walker 2004)

Second, consonant harmony is further restricted in terms of what features spread and what segments are affected. For example, while there are languages in which some feature spreads from one coronal to another, or some laryngeal feature spreads from one obstruent to another, there are no languages in which primary consonant place spreads across vowels. This gap is not accidental, but instead offers evidence for what constraints are involved in assimilation. In the current context, this gap is attributed to the typology of alignment constraints. In section 3.3.1, I proposed that primary place features can have root nodes and vowels—but not consonants—as targeted structures. These constraints cannot produce a language in which a primary place feature spreads from one consonant to another across vowels. This is true even if feature co-occurrence constraints are taken into account, since they never prefer skipping of segments, as shown in section 6.4.3.

Third, with the exception of coronal, nasal and liquid harmonies, all other types are limited to a few languages (three or less, usually related). This casts a strong doubt on these rare patterns. Relying on a small number of languages to make a theoretical claim is a risky enterprise. One problem is that a small number of languages allows very limited typological generalizations. A more serious challenge is that casting doubt on a single pattern quickly makes all other similar patterns suspicious. A good example of this kind of pattern is voicing consonant harmony. Only two languages have been reported to have voicing assimilation of obstruents across vowels: Yabem and Kera. However, both have been since reanalyzed as cases of tone–consonant interactions. In both cases voiced obstruents co-occur with low tone or voiceless obstruents co-occur with high tone (Hansson 2004, 2007b;

Pearce 2006, 2007, 2009). Consequently, there are no clear voicing consonant harmony patterns. This strongly suggests that rare patterns, such as many cases of consonant harmony, need to be subject to heightened scrutiny.

The point I am advancing in this section is that the peculiar properties of consonant harmony are because of its predominantly parasitic nature. Only because consonant harmony is parasitic, it can skip vowels or even other consonants. This is attributed to agreement constraints. In particular, agreement constraints prefer spreading to a subset of segments targeted by alignment constraints. The targets can be in adjacent syllables (as we have seen in rounding harmony) or not, and this depends on the ranking of feature co-occurrence constraints. If feature co-occurrence constraints are ranked below the alignment constraint, agreement constraints prefer spreading to any target within the domain of the alignment constraint. In short, parasitic patterns can refer to vowels (as seen for rounding harmony in sections 8.3–8.4) or consonants (as in consonant harmony).

In what follows, I focus on the two most common types of consonant harmony: coronal harmony and nasal consonant harmony. These two serve as examples, which demonstrate that other cases of consonant harmony can be straightforwardly dealt with within the current framework.

The first type of consonant harmony involves alternations between different types of sibilants to the exclusion of all other segments. In the current context, feature spreading is attributed mainly to alignment constraints. This is what we have seen in consonant harmony in Sanskrit (4.4), which targets all coronals. The caveat is that only nasals become retroflex, but this was attributed to a high ranked feature co-occurrence constraint. Most other cases of coronal consonant harmony are parasitic, which requires a high ranked agreement constraint. This is the case in sibilant harmony found in Aari, Koyra, and Slovenian. In section 8.5.2, I show that these languages differ primarily in blocking segments, which is another property that makes consonant harmony similar to other cases of assimilation. Kalasha, discussed in section 8.5.3, presents a case in which even more agreement constraints interact. The current approach can account for all these patterns.

Nasal consonant harmony is the second type, which involves alternations between voiced consonants which become nasal sonorant stops. Nasality spreads across vowels, which are not reported to be nasalized. This clearly contradicts the analysis of nasal harmony proposed in section 6.6.2, where it is shown that vowels cannot be transparent to nasal harmony. However, this is only true when nasality spreads due to alignment. When a high ranked agreement constraint is specific to nasal sonorant stops, spreading to nasal sonorant stops is preferred, and vowels are transparent to this process. Nasal consonant harmony in Yaka is analyzed in section 8.5.4.

### 8.5.2 Sibilant harmony

This section presents three cases of sibilant harmony. I argue that alignment is insufficient to analyze these patterns and needs to be complemented by a dominant agreement constraint. Consequently, the fact that consonant harmony is primarily a parasitic phenomenon is not unexpected. The second point concerns blocking in consonant harmony. I show that Aari, Koyra, and Slovenian differ in what segments block consonant harmony. Blocking by a subset of consonants suggests that consonant harmony is much like other cases of assimilation.

#### Aari

I begin by an analysis of sibilant harmony in Aari. Aari has a progressive root-to-suffix spreading that affects only sibilants. Vowels and all other consonants, including coronals, are skipped. One prediction of agreement constraints is that they may cause skipping of non-participating segments. This is in fact what is attested in Aari. In short, the relevant agreement constraint requires coronal fricatives to agree in terms of anteriority.

Aari (Hayward 1988, 1990) exhibits a rather prototypical case of sibilant harmony. Suffix coronal fricatives alternate depending on the coronal fricatives in the root. In (270) we see two alternating suffixes. Posterior fricatives {ʃ, ʒ} follow posterior coronal fricatives or affricates in the root (righthand column), while anterior fricatives {s, z} surface in all other cases (lefthand column).

(270) Aari sibilant harmony (Hayward 1988:290; Hayward 1990:467–470)

|    |                    |          |              |                |
|----|--------------------|----------|--------------|----------------|
| a. | /-sis/ ‘CAUSATIVE’ |          |              |                |
|    | giʔ-sis-           | ‘hit’    | naʃ-fiʃ-     | ‘like, love’   |
|    | duuk-sis-          | ‘bury’   | tʃʔaʃq-fiʃ-  | ‘curse, swear’ |
|    | sug-zis-           | ‘push’   | ʃen-fiʃ-     | ‘buy’          |
|    | mer-sis-           | ‘forbid’ | ʒa:q-fiʃ-    | ‘throw’        |
| b. | /-s/ ‘PERFECTIVE’  |          |              |                |
|    | giʔ-s-it           | ‘hit’    | qaʒ-ʒ-it     | ‘get cold’     |
|    | duuk-s-it          | ‘bury’   | tʃʔaʃq-f-it  | ‘curse, swear’ |
|    | sug-z-it           | ‘push’   | ʔuf-f-it     | ‘cook’         |
|    | giʔ-er-s-it        | ‘be hit’ | ʒaʃq-er-f-it | ‘be thrown’    |

In the approach advocated in this thesis, spreading is featural alignment within a domain. This approach also makes sense in the context of Aari sibilant harmony, which can be seen as progressive spreading of posteriority to coronals within a prosodic word. This requires reference to two features. The targeted structure is [coronal]. The spreading feature is [posterior]. This feature is not problematic, as it is the privative version of the binary [–anterior], which is a well established



feature (McCarthy 1988; Cho 1991; Shaw 1991; Hall 1997), as seen in the analysis of Nati (section 4.4.2). In the current model, the feature [posterior] is generally not limited to any major place of articulation, or even to consonants. We know this because languages exhibit local interactions between front or high vowels and coronals. However, if [posterior] spreads, it targets coronal consonants rather than any other segments. This generalization can be captured by two alignment constraints that have [posterior] as the spreading feature. The targeted structure of the first constraint is a root node.<sup>5</sup> The targeted structure of the second constraint is [coronal]. Other targeted structures—including [labial] or [sonorant]—are not allowed. In Aari, the relevant alignment constraint is \* $\omega$ ([posterior], coronal). This constraint outranks the faithfulness constraint DEP LINK[posterior].

Yet, this ranking is insufficient, as we would predict that [posterior] spreads to all coronals, including stops and sonorants. We have seen a very similar pattern in Sanskrit, except that the spreading feature is [retroflex] (section 4.4). In Aari, however, [posterior] spreads only from coronal fricatives/affricates to other fricatives/affricates.<sup>6</sup> This resembles the parasitic pattern demonstrated on rounding harmony. In particular, [posterior] is parasitic in that the trigger and the target are both neither stops nor sonorants. The agreement constraints require that coronals agree in terms of major class features. I use two features [stop] and [sonorant], which come in two constraints: AGREE([posterior], stop) (271-a) and AGREE([posterior], sonorant) (271-b). These two constraints will have the combined effect in which spreading will be preferred to obstruent non-stops (i.e., fricatives and affricates). Here I assume [stop] is a feature common exclusively to oral plosives.

- (271) a. AGREE([posterior], stop)  
 A root node is fully associated with [posterior] and [stop] iff all root nodes fully associated with that [posterior] are also fully associated with some [stop].
- b. AGREE([posterior], sonorant)  
 A root node is fully associated with [posterior] and [sonorant] iff all root nodes fully associated with that [posterior] are also fully associated with some [sonorant].

The current approach also predicts many other agreement constraints with [posterior] as the spreading feature. We will see some of these in the following sections. However, I will not attempt to restrict what targeted structures are generally possible with [posterior] as the spreading feature.

<sup>5</sup>For further discussion of \* $\omega$ ( $\times$ , [posterior]), see (304).

<sup>6</sup>The data in (270) does not contain any targeted affricates. In this section, I will describe spreading within fricatives. I add spreading to affricates when discussing Koyra below.

The ranking is shown in (272). The input contains a posterior coronal fricative, followed by three coronals, only one of which is a fricative. Candidate (a) is faithful and violates the alignment constraint three times. Candidate (b) has spreading only to the coronal fricative, but not to the sonorant and the stop, violating the alignment constraint twice. However, neither of the two agreement constraints are violated because all root nodes fully associated with [posterior] are neither stops nor sonorants. Candidate (c) with spreading to all coronals, on the other hand, fatally violates both agreement constraints. For example, candidate (c) violates AGREE([posterior],stop) once, because all not posterior nodes associated with the stop [c] are also stops themselves.

(272) baferʃit ‘I was overcome’

| <p style="text-align: center;">[p]<br/>/ b a - e r - ʃ i t /<br/>[c] [c] [c] [c]</p>                                                                                                                                                                                                                                                                                                     | <p style="text-align: center;">AGREE<br/>([post],stop)</p> | <p style="text-align: center;">AGREE<br/>([post],son)</p> | <p style="text-align: center;">*ω([post],cr)</p> | <p style="text-align: center;">DEPLK[post]</p> |
|------------------------------------------------------------------------------------------------------------------------------------------------------------------------------------------------------------------------------------------------------------------------------------------------------------------------------------------------------------------------------------------|------------------------------------------------------------|-----------------------------------------------------------|--------------------------------------------------|------------------------------------------------|
| <p>a.</p> <p style="text-align: center;">[p]<br/>b a e r ʃ i t<br/>[c] [c] [c] [c]</p>                                                                                                                                                                                                                                                                                                   |                                                            |                                                           | <p style="text-align: center;">***!</p>          |                                                |
| <p>b. </p> <p style="text-align: center;">[P]<br/>b a e r ʃ i t<br/>[c] [c] [c] [c]</p> <p><i>(Diagram: A root node [P] branches to [p] and [ʃ]. [p] branches to [p] and [r]. [r] branches to [r] and [ʃ]. [ʃ] branches to [ʃ] and [i]. [i] branches to [i] and [t]. All leaf nodes are [c].)</i></p> |                                                            |                                                           | <p style="text-align: center;">**</p>            | <p style="text-align: center;">*</p>           |
| <p>c.</p> <p style="text-align: center;">[P]<br/>b a e r ʃ i t<br/>[c] [c] [c] [c]</p> <p><i>(Diagram: A root node [P] branches to [p] and [ʃ]. [p] branches to [p] and [r]. [r] branches to [r] and [ʃ]. [ʃ] branches to [ʃ] and [i]. [i] branches to [i] and [t]. All leaf nodes are [c].)</i></p>                                                                                     | <p style="text-align: center;">*(!)</p>                    | <p style="text-align: center;">*(!)</p>                   |                                                  | <p style="text-align: center;">***</p>         |

We have now seen that the approach based on agreement and alignment constraints can adequately account for Aari sibilant harmony. Thus, the proposed agreement constraints in combination with alignment predict sibilant harmony. In section 8.4 we have seen that agreement constraints can block spreading when the trigger and the target disagree in some feature. This is achieved by ranking agreement above alignment. The remaining issue is how the feature co-occurrence constraints are ranked. As seen in chapter 6, feature co-occurrence constraints enforce segmental blocking. In most cases of rounding harmony, these are ranked below alignment, as

there are no segmental blockers. Turkish, on the other hand, provides a pattern, in which any open vowel blocks rounding harmony, and such blocking is independent of what the trigger is (section 8.4.3). This is attributed to a feature co-occurrence constraint ranked above alignment. Consonant harmony is very much like rounding harmony in that agreement constraints can block spreading if the trigger and target disagree in some feature. Furthermore, in most, but not all cases of consonant harmony, feature co-occurrence constraints that block spreading are ranked below the alignment constraints, as it is the case in Aari. This is why [posterior] can spread across other coronals. In the next section, I provide a case of consonant harmony in which all consonants block spreading. Consequently, [posterior] spreads only when the trigger and the target are not separated by another consonant. This is attributed to a high ranked feature co-occurrence constraint, which is directly parallel to the blocking pattern found in Turkish rounding harmony.

### **Koyra**

Another case of sibilant harmony is found in Koyra. This language exhibits sibilant harmony which is minimally different from the kind found in Aari. This is unsurprising since both languages are closely related, and sibilant harmony is generally quite common in Omotic languages (Hansson 2001:62). The interesting bit in which the two languages differ is that the trigger and the target can be separated by at most one vowel in Koyra, while there is not such restriction in Aari, as we have seen above. The proximity restriction is an instance of blocking: all non-alternating consonants block spreading. In the current approach, blocking is attributed to a high ranked feature co-occurrence constraint.

Koyra (Hayward 1982) has progressive root-to-suffix sibilant harmony. A root anterior sibilant (fricative or affricate) is followed by a suffix anterior sibilant. Some root posterior sibilants (fricatives or affricates) are followed by a suffix posterior sibilant (273-a). However, the data in (273-b) show that this is not always the case. The trigger and the target can be separated by maximally one vowel. To put it differently, all non-sibilant consonants block spreading. Blocking is frequently found in feature spreading, so it is not surprising that it is also found in consonant harmony.

- (273) Koyra sibilant harmony (Hayward 1982:245,246,252; Hayward 1988:291)
- a. Spreads to suffixes
- |               |                         |
|---------------|-------------------------|
| tup-us-       | ‘cause to lie’          |
| zuum-us-      | ‘cause to crawl’        |
| suuz-us-      | ‘cause to bless’        |
| paʃ-uʃ-       | ‘cause to cover up’     |
| ʔatʃ-uʃ-      | ‘cause to reap’         |
| dʒaʃ-uʃ-      | ‘cause to fear’         |
| gootʃ-uʃ-     | ‘cause to pull’         |
| ʔordʒ-uʃ-     | ‘increase’              |
| ʔordʒ-oʃʃo    | ‘he increased’          |
| patʃtʃ-oʃʃo   | ‘it became less’        |
| giiʒʒ-oʃʃo    | ‘it supported’          |
| miʃʃ-uʃʃo     | ‘I am replete’          |
| dʒaʃ-uʃ-ɛʃʃe  | ‘let him frighten s.o.’ |
| ʔatʃ-uʃʃ-uʃʃo | ‘I had s.o. reap’       |
- b. Blocked by all other consonants
- |               |                           |
|---------------|---------------------------|
| zuum-uss-osso | ‘he caused s.o. to crawl’ |
| ʃod-us-       | ‘cause to uproot’         |
| ʃoh-us-       | ‘wash (tr.)’              |
| ʃirk-us-      | ‘cause to rub’            |
| tʃʰaan-us-    | ‘cause to load’           |
| ʃodd-osso     | ‘he uprooted’             |
| ʔatʃ-utt-osso | ‘he reaped’               |

In the current context, blocking is attributed to high ranked feature co-occurrence constraints. In Koyra, all non-sibilant consonants are blockers. This requires several feature co-occurrence constraints. In what follows, I will demonstrate blocking by coronal stops, but this can be easily extended to all other consonants.

The Koyra pattern is very similar to Aari. Both are progressive and involve the feature [posterior], which spreads within sibilants. Hence it makes sense to use the same ranking of constraints in both languages. This ranking is in (272). The difference is that in Koyra the constraint against posterior non-sibilant consonants is ranked higher than all other constraints. This effectively blocks spreading. Here I will focus on stops, so I will use the constraint \*[posterior stop]. Other feature co-occurrence constraints are also needed by extension.

The effect of this ranking is shown in (274). I include all constraints from the Aari ranking in (272), while adding a high ranked \*[posterior stop]. Given the ranking in Aari, we would expect candidate (b) with spreading to sibilants to win. However, the high ranked feature co-occurrence constraint blocks spreading, and the faithful candidate (a) wins, despite two violations of the alignment constraint.

(274) fodus ‘cause to uproot’

| <p>[p]<br/>/ ↓ o d - u s̥ - /<br/>[c] [c] [c]</p>                          | *[post st] | AGREE<br>([post],st) | AGREE<br>([post],son) | *ω([post],cr) | DEPLK[cr] |
|----------------------------------------------------------------------------|------------|----------------------|-----------------------|---------------|-----------|
| <p>a. ↗</p> <p>[p]<br/>↓<br/>[c] o d u s̥<br/>[c] [c] [c]</p>              |            |                      |                       | **            |           |
| <p>b.</p> <p>[P]<br/>p<br/>p<br/>p<br/>p<br/>↓ o d u ↓<br/>[c] [c] [c]</p> | d!         |                      |                       | *             |           |
| <p>c.</p> <p>[P]<br/>p P<br/>p p<br/>p p<br/>↓ o ↓ u ↓<br/>[c] [c] [c]</p> | ʃ(!)       | *(!)                 |                       |               | **        |

Koyra and Aari are minimally different in that non-sibilants block spreading in Koyra, but not in Aari. Blocking is attributed to feature co-occurrence constraints, which is entirely consistent with the current approach to feature spreading. In the larger scheme of things, both blocking and parasitic properties of sibilant harmony suggest that all assimilation patterns constitute a single phenomenon, with straightforwardly identifiable properties. The remaining case of sibilant harmony in Slovenian provides even stronger evidence for blocking in consonant harmony.

### Slovenian

So far we have seen two cases of sibilant harmony which differ solely in blocking. This section provides another case of sibilant harmony which is intermediate between the two. In Slovenian, only some consonants block spreading. In particular, only coronal stops block spreading, while all other coronals, non-coronals and vowels are transparent. These blocking effects are important because they show that consonant harmony is similar to other cases of assimilation.

Colloquial Slovenian (henceforth, Slovenian) exhibits alternations between anterior and posterior coronal fricatives and affricates. Unlike the previous cases,

sibilant harmony in Slovenian is optional.<sup>7</sup> However, this optionality is restricted, such that not all possible variants are grammatical.

The Slovenian coronal inventory is in (275). We see that in addition to fricatives and affricates, Slovenian has two stops and four sonorants. Only fricatives and affricates participate in sibilant harmony.

|       |                             |   |   |    |    |            |   |   |   |   |
|-------|-----------------------------|---|---|----|----|------------|---|---|---|---|
| (275) | Slovenian coronal inventory |   |   |    |    |            |   |   |   |   |
|       | [stop]                      |   |   |    |    | [sonorant] |   |   |   |   |
|       | t                           | s | ʃ | ts | tʃ |            |   |   |   |   |
|       | [voice]                     | d | z | ʒ  | dz | dʒ         | l | r | j | n |

The data in (276) show that all coronal fricatives or affricates within a word are generally either anterior or posterior. More specifically, anterior coronal fricatives or affricates become posterior when followed by a posterior fricative or affricate.<sup>8</sup>

|            |                            |                       |                |  |
|------------|----------------------------|-----------------------|----------------|--|
| (276)      | Slovenian sibilant harmony |                       |                |  |
| sl-ux      | ‘hearing’                  | ʃl- <u>i</u> -i       | ‘hears’        |  |
| sux        | ‘dry’                      | ʃu- <u>ʃ</u> -i       | ‘dries’        |  |
| spi        | ‘sleeps’                   | ʃpi- <u>ʃ</u>         | ‘(you) sleep’  |  |
| tsepəts    | ‘fool’                     | tʃeptʃ- <u>ək</u>     | ‘fool-DIM’     |  |
| zapɔr      | ‘prison’                   | ʒapɔr-ni- <u>ʃki</u>  | ‘prison-ADJ’   |  |
| zew        | ‘plant’                    | ʒel- <u>i</u> tʃe     | ‘herb’         |  |
| za-klɔn    | ‘shelter’                  | ʒa-klɔn-i- <u>tʃe</u> | ‘bomb shelter’ |  |
| zajɔts     | ‘rabbit’                   | ʒajtʃ- <u>ək</u>      | ‘rabbit-DIM’   |  |
| z-ved-e-ti | ‘PERF-know’                | ʒ-oʒ-i-ti             | ‘PERF-narrow’  |  |
| pozabi     | ‘forgets’                  | poʒabi- <u>ʃ</u>      | ‘(you) forget’ |  |

Upon closer examination, it turns out that assimilation is strictly regressive, but never progressive, as shown in (277). A posterior root (or prefix) sibilant can be followed by an anterior sibilant, but not vice versa. The pattern is independent of any morphological effects. More specifically, prefixes can be affected by either roots or suffixes, and roots can be affected by suffixes. Similarly, suffixes are affected by any following, but not preceding, suffixes.

<sup>7</sup>Sibilant harmony is quite pervasive across dialects. Standard Slovenian exhibits a local variant of sibilant assimilation, which never applies across non-sibilants. Sibilant harmony in another Slavic language, Russian displays even more optionality (Kochetov & Radišić 2009).

<sup>8</sup>Slovenian also has an alternation involving front vowels and coronal consonants. A full analysis of this pattern is left for future research.

(277) Rightward, not leftward, sibilant harmony

|                 |              |                                    |                                      |              |
|-----------------|--------------|------------------------------------|--------------------------------------|--------------|
| <u>z</u> ival-i | ‘animal-GEN’ | <u>z</u> ival- <u>s</u> ki         | * <u>z</u> ival- <u>f</u> ki         | ‘animal-ADJ’ |
| <u>ʃ</u> al-a   | ‘joke-NOM’   | <u>ʃ</u> al- <u>i</u> t <u>s</u> a | * <u>ʃ</u> al- <u>i</u> t <u>ʃ</u> a | ‘joke-DIM’   |
| <u>dʒ</u> ip    | ‘jeep’       | <u>dʒ</u> ip-ow- <u>s</u> ki       | * <u>dʒ</u> ip-ow- <u>f</u> ki       | ‘jeep-ADJ’   |
| <u>tʃ</u> el-o  | ‘cello’      | <u>tʃ</u> el- <u>i</u> st          | * <u>tʃ</u> el- <u>i</u> ft          | ‘cellist’    |

Another property of Slovenian sibilant harmony concerns blocking segments. As examples above show, vowels and sonorants are transparent to sibilant harmony. However, in (278) we see that the harmony is blocked by coronal obstruent stops.

(278) Obstruent stops block sibilant harmony

|                 |                 |                             |                              |                 |
|-----------------|-----------------|-----------------------------|------------------------------|-----------------|
| <u>s</u> it     | ‘full’          | na- <u>s</u> it- <u>i</u> ʃ | *na- <u>f</u> it- <u>i</u> ʃ | ‘(you) feed’    |
| <u>z</u> ida    | ‘(s/he) builds’ | <u>z</u> ida- <u>f</u>      | * <u>z</u> ida- <u>f</u>     | ‘(you) build’   |
| <u>ʃ</u> oji    | ‘stands’        | <u>ʃ</u> oji- <u>f</u>      | * <u>ʃ</u> oji- <u>f</u>     | ‘(you) stand’   |
| <u>tsitr</u> -e | ‘zither’        | <u>tsitr</u> -a <u>f</u>    | * <u>tʃ</u> itr-a <u>f</u>   | ‘zither player’ |

Slovenian differs from Koyra in two respects. First, harmony in Slovenian is regressive and not progressive. Second, only coronal obstruent stops block spreading in Slovenian, whereas all consonants block spreading in Koyra. The two typological differences can be easily accounted for. The difference in directionality is attributed to alignment constraints. The alignment constraint \* $\omega$ ([post], cor) in Koyra has the opposite f-precedence relations than the alignment constraint \* $\omega$ (cor, [post]) in Slovenian. The difference in blocking is attributed to the ranking of feature co-occurrence constraints. In Slovenian only \*[posterior coronal obstruent stop] (henceforth, \*c) outranks alignment, such that coronal stops block spreading. On the other hand, the constraints \*[posterior stop] and \*[posterior sonorant] are ranked below alignment, such that the remaining, non-coronal stops and all sonorants are transparent. In Koyra, the latter two constraints outrank alignment.

The ranking is illustrated with an input containing two targets and two transparent coronals in (279). The faithful candidate violates the alignment constraint once more than the winning candidate (b). The remaining three candidates violate alignment fewer times, but violate the high ranked feature co-occurrence constraint and agreement. Hence, spreading can skip all segments except coronal stops.

(279) zatefnif ‘you tighten it up’

| $\begin{array}{ccccccc} & & & & & & [p] \\ & & & & & &   \\ / & z & a & - & t & e & s & - & n & - & i & - & / \\ &   & & &   & &   & &   & &   & &   \\ & [c] & & & [c] & & [c] & & [c] & & [c] & & [c] \end{array}$ | * <sub>c</sub> | AGREE<br>([post],stop) | AGREE<br>([post],son) | * $\omega$ (cor, <sub>1</sub> [post]) | *[post son] | DEP LINK[cor] |
|----------------------------------------------------------------------------------------------------------------------------------------------------------------------------------------------------------------------|----------------|------------------------|-----------------------|---------------------------------------|-------------|---------------|
| <p>a.</p> $\begin{array}{ccccccc} & & & & & & [p] \\ & & & & & &   \\ z & a & t & e & s & n & i \\   & &   & &   & &   \\ [c] & & [c] & & [c] & & [c] \end{array}$                                                   |                |                        |                       | ****!                                 |             |               |
| <p>b. </p>                                                                                                                          |                |                        |                       | ***                                   | *           | *             |
| <p>c.</p>                                                                                                                                                                                                            |                |                        | *!                    | **                                    | *           | **            |
| <p>d.</p>                                                                                                                                                                                                            | *!             |                        |                       | **                                    | *           | **            |
| <p>e.</p>                                                                                                                                                                                                            | *(!)           | *(!)                   | *(!)                  |                                       | *           | *****         |

This concludes the analysis of Slovenian. The three reviewed languages with sibilant harmony involve the same triggers and targets, but differ in what segments block harmony. Blocking is attributed to high ranked feature co-occurrence con-



straints. We can conclude that consonant harmony is similar to other types of harmony in terms of blocking (contra Hansson 2001:209ff.; Rose & Walker 2004:486). Sibilant harmony is by far the most common type of consonant harmony. This is related to the fact that coronals are cross-linguistically most common and diverse consonants. Consequently, we would also expect the greatest variation with respect to blocking. This is what is actually found. In Aari, no segments block spreading, while in Koyra all non-sibilant consonants block spreading. Slovenian presents an intermediate situation, where only coronal stops block spreading. Another well-known case of blocking is Kinyarwanda, in which all non-sibilant coronals block retroflex harmony (Walker et al. 2008).<sup>9</sup>

In what remains, I look at another striking property of coronal harmony. The cases reviewed so far exhibit asymmetric parasitic harmony in that spreading is limited to one class, while it is absent from the other. Recall Kachin rounding harmony from section 8.4.4. In Kachin, rounding applies if both the trigger and the target are high vowels. Open vowels display no harmony. Similarly, spreading of posteriority in Aari, Koyra, and Slovenian is limited to sibilants, while stops and sonorants do not display any alternations. Symmetric parasitic patterns, on the other hand, involve spreading of one feature dependent on the agreement of the other. In particular, either both the trigger and the target have the same feature, or neither has it. This is what is found in Yowlumne (section 8.3) in which both high and open vowels cause rounding of the following vowels, but only if triggers and targets agree in vowel height. In the next section, I present such a parasitic pattern in coronal harmony. These data additionally support the idea that parasitic phenomena in rounding and consonant harmony are directly parallel.

### 8.5.3 Kalasha retroflex harmony

After reviewing three cases of sibilant harmony, I now look at alternations that also involve non-sibilant coronals. Recall Nati in Sanskrit discussed in section 4.4. Nati can be characterized as a case of retroflexion which spreads from a coronal continuant to a coronal nasal. Nati does not exhibit any prototypical parasitic properties, because triggers and targets may be different in terms of all features except for [coronal]. This gives evidence that the alignment constraint involving retroflexion can have [coronal] as the targeted structure. The fact that non-continuants fail to trigger and propagate retroflexion is a separate variable, which is due to the constraints on feature heads. On the other hand, if Nati exhibited parasitic behavior, we would expect spreading of retroflexion within continuants and non-continuants, but not across the two groups of segments.

---

<sup>9</sup>The Kinyarwanda data are complicated by additional failing triggers. As we have seen in chapters 4–8.4, failing triggers are a well attested pattern in all other types of assimilation.

In this section, I look at a parasitic pattern involving retroflexion. In Kalasha (Morgenstierne 1973; Trail nd; Mørch & Heegård 1997; Heegård & Mørch 2004; Bashir 2003; Arsenault & Kochetov to appear), retroflexion of coronals within roots is restricted, such that any two coronal stops are either both retroflex or neither is, and this is also true for any two affricates and fricatives. These static distributional restrictions exhibit parasitic properties, although they are not necessarily cases of assimilation. Apparent parasitism is important when one compares feature spreading in the current model with other analyses of consonant harmony, such as Agreement by Correspondence (Hansson 2001; Rose & Walker 2004). My aim in what follows is threefold. First, I extend the analysis based on sibilants to other coronals and other spreading features. Second, I demonstrate that alignment and agreement constraints can perfectly capture both active alternations seen in assimilation on the one hand and static patterns, which are traditionally referred to as morpheme structure constraints (henceforth, MSCs), on the other. Third, I argue that agreement constraints can capture the three-way parasitic pattern found in Kalasha.<sup>10</sup>

Kalasha exhibits a puzzling restriction on combinations of retroflex and non-retroflex coronal obstruents (Arsenault & Kochetov to appear). The particular combinations of obstruents I focus on are root-initial  $C_1VC_2$  sequences, where both consonants are coronal obstruents. In (280-a), we see that if the first coronal is non-retroflex, the second will generally be retroflex. The only exception is when the two coronals are both of the same manner of articulation (fricatives, affricates, or stops). In this case, both coronal obstruents are non-retroflex. Put differently, coronal obstruents always agree in retroflexion if they have the same manner (i.e., they are either stops, fricatives or affricates). The second set of data (280-b) shows cases in which the first coronal is retroflex. In this case, too, the second coronal usually disagrees with the first one in terms of retroflexion. However, both coronals are retroflex only if they are of the same manner. For example, a retroflex fricative can only be followed by another retroflex fricative—as in [ʃuʃik] ‘to dry’—, but not by a non-retroflex one—e.g. \*[ʃusik].

---

<sup>10</sup>Mørch & Heegård (1997), Heegård & Mørch (2004) describe the language as having retroflex vowels, which variantly spread retroflexion to other segments. This fact is not specifically analyzed in Arsenault & Kochetov (to appear). From the existing literature, it is impossible to tell whether and how the two patterns interact. If they do, then Kalasha does not exhibit parasitic retroflex harmony, but simply local spreading. Henceforth, I will assume that the data of Arsenault & Kochetov (to appear) is correct and that vowel retroflexion is a separate process, which possibly interacts with consonant retroflexion.

(280) Kalasha retroflex harmony (Arsenault &amp; Kochetov to appear: ex. 7–12)

a. The first coronal is non-retroflex (agreement underlined)

| 1 <sup>ST</sup> CORONAL                    |                                  |                                           |                |                         |
|--------------------------------------------|----------------------------------|-------------------------------------------|----------------|-------------------------|
| FRICATIVE                                  | AFFRICATE                        | STOP                                      |                |                         |
| 1 <u>ci</u> goa<br>'handsome'              | 3 t <u>ca</u> ʃ<br>'lunch'       | 6 tuʃ<br>'straw'                          | STOP AFFR FRIC | 2 <sup>ND</sup> CORONAL |
| (no data)                                  | 4 ts <u>ě</u> saw<br>'squirrel'  | 7 di <u>ʃ</u><br>'period of abstinence'   |                |                         |
| 2 ɕo <u>t</u> <sup>h</sup> a<br>'a growth' | 5 tsa <u>t</u> ẽgik<br>'to move' | 8 da·u ta <u>u</u><br>'festival of beans' |                |                         |

b. The first coronal is retroflex (agreement underlined)

| 1 <sup>ST</sup> CORONAL      |                                               |                                                    |                |                         |
|------------------------------|-----------------------------------------------|----------------------------------------------------|----------------|-------------------------|
| FRICATIVE                    | AFFRICATE                                     | STOP                                               |                |                         |
| 9 ʃ <u>u</u> ʃik<br>'to dry' | (no data)                                     | 14 ʃusu djek<br>'to peck'                          | STOP AFFR FRIC | 2 <sup>ND</sup> CORONAL |
| 10 ʃate<br>'shelter'         | 12 d <u>z</u> a <u>t</u> ʃ<br>'spirit beings' | 15 ʃõt <u>ɕ</u> uk<br>'active'                     |                |                         |
| 11 ʃit<br>'tight-fitting'    | 13 ʃ <u>s</u> at<br>'moment'                  | 16 t <sup>h</sup> <u>e</u> t karik<br>'to scatter' |                |                         |

Perhaps the most obvious solution in response to these curious segment co-occurrence restrictions would be to say that they do not constitute a productive pattern and that they are in any case not assimilation patterns, since there are no active alternations. While this is true, one should keep in mind that the current model sees assimilation as feature spreading. Feature spreading may account for patterns other than assimilation, including some MSCs. Another reason for analyzing static patterns in Kalasha using the current model is due to one of the basic assumptions of OT. Given Richness of the Base, we need to capture Kalasha MSCs in some way or another. More specifically, Richness of the Base requires that an input with a retroflex coronal stop and fricative maps to a licit output in which only one is retroflex. Similarly, inputs with a retroflex and non-retroflex coronal stop must map to a licit output in which both segments are retroflex. The latter alternation can be formalized in terms of feature spreading, although it is not supported by alternations. I will thus analyze this pattern using the feature spreading mechanism. For these reasons I also refer to it as retroflex harmony.

In terms of feature spreading, Kalasha co-occurrence restrictions can be formalized as parasitic bidirectional spreading of the feature [retroflex].<sup>11</sup> What this means is that any retroflex segment will trigger spreading in either direction, but only if the trigger and the target agree in the manner of articulation. In other words, any retroflex coronal will spread the feature progressively and regressively,

<sup>11</sup>For discussion pertaining to the existence of the feature [retroflex] see section 4.4.2.

unless the target is of a different manner. This can be attributed to alignment constraints which are outranked by agreement constraints, as we have seen for sibilant harmony in section 8.5.2.

There are three major differences between the reviewed cases of sibilant harmony and Kalasha retroflex harmony. First, there are two alignment constraints in Kalasha, one for each direction. Second, the alignment constraints have the root, not the prosodic word, as the domain. The two alignment constraints are *\*root*([retroflex], coronal) and *\*root*(coronal, [retroflex]). Third, the agreement constraints require distinction between affricates and fricatives, which was not the case in sibilant harmony. Thus, in addition to the agreement constraints referring to sonorants—*AGREE*([retroflex], sonorant)—and stops—*AGREE*([retroflex], stop)—another constraint is needed. Fricatives differ from affricates in terms of the feature [continuant], hence the relevant constraint is *AGREE*([retroflex], continuant). All constraints outrank the faithfulness constraint *DEPLINK*[retroflex].

Showing the full effect of all these constraints would require many classical tableaux. An easier way to show spreading and lack of spreading for many different combinations of coronals is to use a comparative tableau (281). For convenience, I adopt a simplified representation, which omits linking to transparent segments. Transparency is not a relevant factor here. Furthermore, I only consider inputs that have one instance of [retroflex] in the input. Inputs without retroflex will surface without spreading, and satisfy all constraints. Only outputs are considered, as faithfulness constraints do not play a crucial role. The numbers preceding the candidates in (281) make reference to the position of these in the dataset in (280).

What we see in the comparative tableau in (281) is that agreement constraints prefer spreading only to coronals that have the same manner of articulation. For example, in tableau (281), the losing candidate (2) violates two highest ranked agreement constraints. The remaining three candidates—(9), (12) and (16)—show spreading, because of the alignment constraint. The agreement constraint referring to sonorants is not relevant to any of the candidates, but is added to allow for a direct comparison with other cases of consonant harmony discussed in the previous section.

## (281) Kalasha retroflex harmony

| Winner ~ Loser                                                                                                      | AGREE<br>([rx],cont) | AGREE<br>([rx],stop) | AGREE<br>([rx],son) | *rt([rx],cor) | *rt(cor,[rx]) | DEPLINK[rx] |
|---------------------------------------------------------------------------------------------------------------------|----------------------|----------------------|---------------------|---------------|---------------|-------------|
| 2 $\begin{array}{c} [r] \quad [R] \\   \quad / \\ \epsilon o t^h a \sim \xi o t^h a \end{array}$                    | W                    | W                    |                     |               | L             | W           |
| 3 $\begin{array}{c} [r] \quad [R] \\   \quad / \\ t\epsilon a \xi \sim t\xi a \xi \end{array}$                      | W                    |                      |                     |               | L             | W           |
| 5 $\begin{array}{c} [r] \quad [R] \\   \quad / \\ tsa t \tilde{e}gik \sim t\xi a t \tilde{e}gik \end{array}$        |                      | W                    |                     |               | L             | W           |
| 6 $\begin{array}{c} [r] \quad [R] \\   \quad / \\ tu \xi \sim t u \xi \end{array}$                                  | W                    | W                    |                     |               | L             | W           |
| 7 $\begin{array}{c} [r] \quad [R] \\   \quad / \\ di t\xi \sim d i t\xi \end{array}$                                |                      | W                    |                     |               | L             | W           |
| 9 $\begin{array}{c} [R] \quad [r] \\ / \quad   \\ \xi u \xi ik \sim \xi us ik \end{array}$                          |                      |                      |                     | W             |               | L           |
| 10 $\begin{array}{c} [r] \quad [R] \\   \quad / \\ \xi a t\epsilon \sim \xi a t\xi \end{array}$                     | W                    |                      |                     | L             |               | W           |
| 11 $\begin{array}{c} [r] \quad [R] \\   \quad / \\ \xi it \sim \xi it \end{array}$                                  | W                    | W                    |                     | L             |               | W           |
| 12 $\begin{array}{c} [R] \quad [r] \\ / \quad   \\ d_z a t\xi \sim d_z a t\xi \end{array}$                          |                      |                      |                     | W             |               | L           |
| 13 $\begin{array}{c} [r] \quad [R] \\   \quad / \\ t\xi a t \sim t\xi a t \end{array}$                              |                      | W                    |                     | L             |               | W           |
| 14 $\begin{array}{c} [r] \quad [R] \\   \quad / \\ t o s u \sim t o \xi u \end{array}$                              | W                    | W                    |                     | L             |               | W           |
| 15 $\begin{array}{c} [r] \quad [R] \\   \quad / \\ t \tilde{o} t\epsilon u k \sim t \tilde{o} t\xi u k \end{array}$ |                      | W                    |                     | L             |               | W           |
| 16 $\begin{array}{c} [R] \quad [r] \\ / \quad   \\ t^h e t \sim t^h e t \end{array}$                                |                      |                      |                     | W             |               | L           |

The tableau in (281) does not include any inputs with two instances of [retroflex]. We predict that one instance of [retroflex] will always delink. This is ultimately attributed to positional faithfulness. In chapter 9, I propose that cases like Kalasha are a special type of assimilation, in which a feature spreads in some cases, but delinks in other cases. A single positional faithfulness constraint is sufficient to account for these patterns. As regards the distinction between the final rather than the initial position, there is no synchronic evidence for either. However, as pointed out by Arsenault & Kochetov (to appear: § 5), a comparison with the closely related languages suggest that harmony is regressive, and hence the final instance of [retroflex] is preserved.

This concludes the analysis of Kalasha. I have shown that agreement constraints can account for a three-way parasitic pattern, in which [retroflex] spreading is restricted within stops, fricatives, or affricates. Furthermore, I have shown that the current approach can deal with co-occurrence restrictions (MSCs). This is an important point, since most literature on consonant harmony explicitly states that feature spreading cannot deal with consonant harmony (Hansson 2001; Rose 2004; Rose & Walker 2004; McCarthy 2007a; Arsenault & Kochetov to appear). The current approach to feature spreading strongly suggests that consonant harmony displays the same characteristics as parasitic vowel harmony.

#### 8.5.4 Yaka nasal consonant harmony

I now move on to another common consonant harmony pattern. Nasal consonant harmony involves alternating voiced obstruents/laterals and nasal sonorant stops. This pattern excludes all other segments, which are transparent to the process. In particular, vowels are also transparent to the pattern. At first, this seems to contradict (regular) nasal harmony, which generally prefers spreading *to* vowels and sonorants. As we have seen in section 6.6.2, vowels and sonorants in regular nasal harmony cannot be transparent. The absence of sonorant transparency is attributed to alignment constraints that contain sonorants and root nodes as targeted structures, but not consonants. Hence, while alignment constraint typology alone predicts nasal harmony, it specifically excludes nasal *consonant* harmony.

The challenge is how to account for both regular nasal harmony and nasal consonant harmony, which are both attested. Clearly, alignment constraints alone are insufficient for this task. However, while most cases of feature spreading are due to alignment, the cases reviewed in this chapter are due to agreement between multiple segments. Parasitic vowel harmony is spreading of one feature dependent on another vocalic feature. Consonant harmony is spreading of one consonantal feature dependent on another consonantal feature. Parasitic assimilation is due to a high ranked agreement constraint. One prediction of this approach is that if the feature co-occurrence restrictions are also outranked by alignment (and agreement)

constraints, spreading can skip segments which are normally not transparent. This means that only a subset of targets determined by a specific alignment constraint are favored by agreement constraints. If the alignment constraint has a root node as the targeted structure, agreement constraints can force spreading to a subset of root nodes. This situation is exactly what happens in nasal consonant harmony, which skips vowels, but targets only nasal sonorant stops, requiring agreement in terms of the features [voice], [sonorant] and [continuant]. The crucial point is that the targets need to agree in these features with the trigger.<sup>12</sup>

Yaka nasal consonant harmony mentioned in section 2.1.2 involves an alternation that changes voiced consonants into nasal sonorant stops (Hyman 1995). In (9) we have seen that the perfective suffix in Yaka usually surfaces as [-idi]. However, when there is a nasal sonorant in the root, the suffix surfaces as [-ini]. More examples are provided in (282). First, the data in (282-a) show that other suffixes containing [d] also alternate with [n] when followed by a root ending on a nasal sonorant stop. The data in (282-b) reveal that the same is true when the trigger and the target are at any distance within the same prosodic word. The intermediate voiceless stops and vowels are transparent to spreading.

(282) Nasal harmony in Yaka (Hyman 1995:6,9,12,13)<sup>13</sup>

|                                                   |                |                  |                    |
|---------------------------------------------------|----------------|------------------|--------------------|
| a. Triggers and targets in adjacent syllables     |                |                  |                    |
| tsub-idi                                          | ‘roam’         | tsum- <u>ini</u> | ‘sew’              |
| kud-idi                                           | ‘chase’        | kun- <u>ini</u>  | ‘plant’            |
| kik-idi                                           | ‘obstruct’     | wun- <u>ini</u>  | ‘murmur’           |
| fut-id-(i)                                        | ‘pay for’      | son- <u>in-</u>  | ‘color for’        |
| hjook-id-(i)                                      | ‘pass by’      | hun- <u>in-</u>  | ‘deceive’          |
| bad-ud-(i)                                        | ‘knock over’   | sun- <u>un-</u>  | ‘untie’            |
| dob-ud-(i)                                        | ‘evacuate’     | hon- <u>un-</u>  | ‘undo, drop’       |
| b. Triggers and targets in non-adjacent syllables |                |                  |                    |
| mak-ini                                           | ‘climb’        | finuk-ini        | ‘sulk’             |
| nik-ini                                           | ‘grind’        | miituk-ini       | ‘sulk’             |
| nat-in-(i)                                        | ‘bring to’     | mek-in-          | ‘try to’           |
| nutuk-in-(i)                                      | ‘lean on’      | miituk-in-       | ‘sulking for’      |
| nik-un-(i)                                        | ‘erase’        | nut-un-          | ‘rush’             |
| dem-is-in-(i)                                     | ‘make sb wait’ | dam-is-in-       | ‘make sb stick to’ |

<sup>12</sup>The remaining question is how to restrict agreement constraints not to force spreading of some features. One option would be that the targeted structure of agreement constraints can never be a consonant or a vowel. This would exclude consonant harmony of primary place features, which is an unattested pattern. I refrain from making any further attempts at restricting the targeted structure of agreement constraints, leaving this issue for further research.

<sup>13</sup>Tones are omitted, since they are not directly relevant to nasal consonant harmony.

Three further observations are needed regarding nasal consonant harmony in Yaka. First, nasalization does not affect only [d], but also [l]. This is because of a separate alternation which involves these two sounds. In words without nasals, [d] surfaces when followed by a high front vowel, while [l] surfaces in all other cases. In (283) we see that Yaka has vowel harmony which influences whether the voiced coronal surfaces as [l] or [d]. The latter is found only before [i]. Nevertheless, when preceded by a nasal, both [l] and [d] turn into a nasal. Henceforth, I will assume that both [l] and [d] are targets.

(283)  $l \rightarrow d / \text{ \_\_\_\_ } i$  (Hyman 1995:6,9)

|                 |           |            |                  |
|-----------------|-----------|------------|------------------|
| tek- <u>ele</u> | kon-ene   | tsub-idi   | tsum- <u>ini</u> |
| ‘sale’          | ‘roll up’ | ‘roam’     | ‘sew’            |
| keb- <u>ele</u> | kem-ene   | kud-idi    | kun- <u>ini</u>  |
| ‘be careful’    | ‘groan’   | ‘chase’    | ‘plant’          |
| sod- <u>ele</u> | son-ene   | kik-idi    | wun- <u>ini</u>  |
| ‘deforest’      | ‘color’   | ‘obstruct’ | ‘murmur’         |

Second, nasality targets all voiced stops, although only {d, l} show actual alternations. As noted by Hyman (1995:16), there are no roots containing a nasal followed by a voiced consonant {b, w, d, l, j}. In contrast, roots with voiceless consonants are perfectly well-formed, as apparent from the data in (282). For instance, there are no words like \*[naja] or \*[mawa], but there are words like [nasa] or [mata]. I take the absence of voiced consonants after nasals as evidence that all voiced consonants are targeted.

Third, prenasalized stops show a different pattern. In (284-a) we see that prenasalized stops do not trigger nasalization. A prenasalized stop may be followed by a voiced obstruent. Surprisingly, prenasalized stops have no effect on spreading. The data in (284-b) show that another nasal can trigger nasalization of the following voiced consonant and prenasalized stops do not interfere with the alternation.

(284) Prenasalized stops (Hyman 1995:9–12)

|                    |               |                      |                 |
|--------------------|---------------|----------------------|-----------------|
| a. Non-triggers    |               |                      |                 |
| bi <u>imb</u> -idi | ‘kiss, hug’   | ha <u>ngg</u> -id-   | ‘do to’         |
| ku <u>und</u> -idi | ‘bury’        | ha <u>amb</u> -ud-   | ‘separating’    |
| ta <u>ang</u> -idi | ‘read, count’ | ha <u>ngg</u> -udud- | ‘rebuild, redo’ |
| b. Propagators     |               |                      |                 |
| bi <u>imb</u> -idi | ‘kiss, hug’   | nu <u>ngg</u> -ini   | ‘win’           |
| ku <u>und</u> -idi | ‘bury’        | pe <u>ngg</u> -ini   | ‘be consumed’   |
| ta <u>ang</u> -idi | ‘read, count’ | na <u>ngg</u> -ini   | ‘last’          |



These data seem surprising at first, since it looks like nasality skips prenasalized stops. Such skipping is problematic because it would require saying that one [nasal] autosegment is linked to two distant root nodes, while another is linked to an intermediate root node. The spreading account runs against the basic assumptions of Autosegmental Phonology, where such representations are ruled out. Alternatively, this effect can be achieved in some frameworks which stipulate agreement rather than spreading (Hansson 2001; Rose & Walker 2004). However, the agreement approach is not available in the current framework. Another option would be to say that prenasalized stops are not nasal at all. While this is possible to state in some frameworks (Hyman 1995), the current approach explicitly rules out this solution. The current model assumes that features are universal and phonetically grounded (section 2.2.1), which means that any nasal segment (including a prenasalized stop) must have the feature [nasal].

I instead propose that prenasalized stops fail to trigger harmony, but at the same time act as propagators. This alternative makes perfect sense in the context of similar patterns in nasal and vowel harmony. Recall the failed triggers, discussed in chapter 7. For instance, in Baiyinna Orochen, long vowels never trigger rounding harmony, but they undergo rounding when triggered by another vowel (section 7.3). Furthermore, many languages exhibit nasal harmony triggered by nasal vowels, but not by nasal sonorant stops. At the same time nasal sonorant stops propagate nasality initiated by a vowel. Mòbà is such an example (section 7.4.2). This strongly suggests that nasal harmony is similar to nasal consonant harmony in that both exhibit failed triggers. Hence, the claim that failing triggers but regular targets are special to nasal consonant harmony but not to other assimilation patterns (Rose & Walker 2004:514) clearly cannot be maintained.

To summarize: Yaka shows consonant harmony in which nasality spreads from a nasal sonorant stop to voiced consonants, skipping vowels and voiceless consonants. Prenasalized stops do not trigger spreading but propagate it. The pattern contrasts with the one found in regular nasal harmony (section 6.6) in one important way: intermediate vowels are not reported to be nasalized. This is especially relevant to the current approach based on alignment constraints. I claimed that in nasal harmony only obstruents can be transparent, whereas sonorants and vowels cannot. This gap is captured by the typology of alignment constraints. Con contains alignment constraints with [nasal] as the spreading feature and the root node or [sonorant]—but not [obstruent]—as targeted structures. Hence, nasal harmony applying across vowels is excluded by the current approach. However, this is only true when spreading is attributed entirely to alignment. When similarity between the trigger and its target also comes into play, skipping of vowels is a very different story. This is because similarity in assimilation is attributed to a separate class of agreement constraints, which spread features to a subset of

segments targeted by alignment constraints. Consequently, some segments that are targeted by alignment may become transparent because of a high ranked agreement constraint.

I proceed with an analysis. In the current context, spreading is driven by alignment which outranks a faithfulness constraint. The relevant alignment constraint has [nasal] as the spreading feature and a prosodic word as the domain. The spreading feature must not f-precede the targets. Targets are only voiced consonants. However, in section 6.6.2 we have seen that constraints with [nasal] can have a root node or [sonorant] as the targeted structure. The former includes both voiced obstruents and sonorants, whereas the latter does not. This suggests that the relevant alignment constraint is  $*\omega([\text{nasal}], \times)$ . Parasitic assimilation is attributed to a high ranked agreement constraint. In Yaka, the trigger and the target must agree in terms of the features [sonorant], [voice], and [continuant]. This means that all triggers and targets either have these features or conversely, no trigger or target have these features. The agreement constraints  $\text{AGREE}([\text{nasal}], \text{sonorant})$ ,  $\text{AGREE}([\text{nasal}], \text{voice})$  and  $\text{AGREE}([\text{nasal}], \text{continuant})$  outrank the alignment constraint  $*\omega([\text{nasal}], \times)$ .

The ranking is shown for an example with spreading in (285). The alignment constraint prefers the candidate with spreading to most segments, unless these violate one of the agreement constraints. Hence, the winning candidate (b) is preferred over the faithful candidate (a). Candidates (d) and (f) show spreading to more segments, violating at least one of the agreement constraints. In Yaka, voicing is never allowed to spread. Hence, the high ranked  $\text{DEPLINK}[\text{voice}]$  excludes any candidate—including (e) below—with voicing of underlyingly voiceless obstruents.

(285) nutun 'rush'

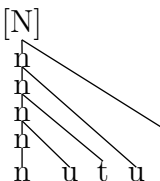
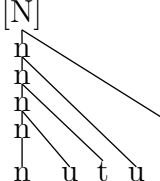
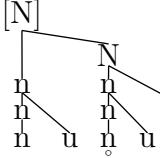
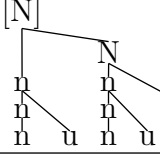
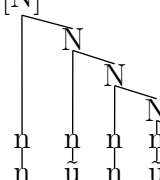
|                                                                                        | DEPLINK[voi] | AGREE<br>([nas],cont) | AGREE<br>([nas],voi) | AGREE<br>([nas],son) | * $\omega$ ([nas], $\times$ ) | DEPLINK[nas] |
|----------------------------------------------------------------------------------------|--------------|-----------------------|----------------------|----------------------|-------------------------------|--------------|
| / $\begin{matrix} [n] \\   \\ n \end{matrix} u t - u d - /$                            |              |                       |                      |                      |                               |              |
| a. $\begin{matrix} [n] \\   \\ n \end{matrix} u t u d$                                 |              |                       |                      |                      | ****!                         |              |
| b.    |              |                       |                      |                      | ***                           | *            |
| c.   |              |                       |                      | *!                   | ***                           | *            |
| d.  |              |                       | *!*                  |                      | **                            | **           |
| e.  | *!           |                       |                      |                      | **                            |              |
| f.  |              | *(!)*                 | *(!)***              |                      |                               | *****        |

The remaining candidate (c) has spreading of nasality only, whereas the winning candidate (b) has nasal spread and several other feature changes, including the epenthesis of [sonorant]. What we see in candidate (b) is that nasalization is insufficient, and needs to be complemented by another feature change. The phenomenon in which assimilation requires an additional feature change is called

‘re-pairing’ and has been first pinpointed by Baković (2000, 2002). Up to this point, I have assumed re-pairing in many cases. For example, most cases of rounding harmony also involve backness harmony, and the fact that rounding sometimes causes backing of targets has been put aside so far. At this point I want to make the feature change caused by assimilation of another feature explicit. Yet I will not give a full account of all re-pairing strategies and possibilities. It suffices to say that other feature changes are influenced by other constraints.

I have now given an account of the basic nasal consonant harmony pattern. I proceed by examining the behavior of prenasalized stops. As we have seen above in (284), prenasalized stops fail to trigger harmony, but allow propagation. This pattern has been attributed to constraints on Heads-of-Heads in chapter 7. There is no reason to take another path here. The remaining question is what features prenasalized stops have compared to regular nasals. Acoustically they are characterized as partially nasal, but having an oral release (see Durvasula 2009 for a recent treatment). I have already used a feature that refers to this phonetic property. Recall the discussion of Ikwere stops in section 4.5. This language exhibits two types of stops: explosive and non-explosive. Only the former have an audible release, while the latter do not. The nasal versions of the two types of stops are nasals (without oral release) and prenasalized stops (with the release). I used the combinations of the features [stop] and [obstruent] to refer to this latter part of the articulation of stops, and I will maintain this here to refer to prenasalized stops. In the current context, Heads-of-Heads of [nasal] cannot be stops, which means that neither obstruent stops nor prenasalized stops can trigger harmony. The constraint \*[NASAL obstruent stop]—see (219) for the constraint template—outranks the alignment constraint.

The behavior of prenasalized stops is shown in the next two tableaux. In (286) we see that a prenasalized stop does not trigger spreading. This is attributed to the constraint on Heads-of-Heads, which is violated by the spreading candidate (b), but not by the faithful candidate (a).

(286) haŋgid ‘do to’

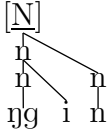
| / h a ŋg - i d - /<br>[n]                                                                                 | *[NAS obs stop] | AGREE<br>([nas], cont) | AGREE<br>([nas], voi) | AGREE<br>([nas], son) | *ω([nas], ×) | DEPLINK[nas] |
|-----------------------------------------------------------------------------------------------------------|-----------------|------------------------|-----------------------|-----------------------|--------------|--------------|
| a.  h a ŋg i d<br>[n]    |                 |                        |                       |                       | **           |              |
| b. <br>h a ŋg i d<br>[N] | *!              |                        |                       |                       | *            | *            |

In (287) we see that another nasal triggers nasalization that targets both the prenasalized stop and the target stop or liquid. A liquid, or any voiced consonant, is also targeted by the agreement constraints. The faithful candidate (a) violates the alignment constraint many times, as opposed to the spreading candidate (b), which violates it only three times. Candidate (c) fares just as good on the alignment constraint, but violates a high ranked agreement constraint because /l/ in this candidate simply maps to [l̃], which leads to the violation of AGREE([nas], cont). Instead, what is attested is that /l/ maps to a nasal sonorant stop [n], which involves another feature change.

(287) nanɣini ‘last’

|                                                                                                                                     | *[NAS obs stop] | AGREE<br>([nas], cont) | AGREE<br>([nas], voi) | AGREE<br>([nas], son) | *ω([nas], ×) | DEPLINK[nas] |
|-------------------------------------------------------------------------------------------------------------------------------------|-----------------|------------------------|-----------------------|-----------------------|--------------|--------------|
| $\begin{array}{c} [n] \quad [n] \\   \quad   \\ / \quad n \quad a \quad \eta g \quad - \quad i \quad l \quad i \quad / \end{array}$ |                 |                        |                       |                       |              |              |
| <p>a.</p> $\begin{array}{c} [n] \quad [n] \\   \quad   \\ n \quad a \quad \eta g \quad i \quad l \quad i \end{array}$               |                 |                        |                       |                       | *** *!****   |              |
| <p>b.</p>                                                                                                                           |                 |                        |                       |                       | ***          | **           |
| <p>c.</p>                                                                                                                           |                 | *!                     |                       |                       | ***          | **           |

The failing trigger in nasal consonant harmony is directly comparable to other assimilation patterns discussed in chapter 7. Both vowel harmony and regular nasal harmony display failing triggers. Hence, failing triggers are not specific to consonant harmony.

Furthermore, nasal consonant harmony in Yaka is similar to other types of assimilation in several other ways. First, it resembles other cases of consonant harmony in that it can be analyzed using agreement and alignment constraints. Second, it resembles parasitic phenomena like vowel harmony. Third, it displays re-pairing seen in many cases of vowel and regular nasal harmony. We can thus conclude that consonant harmony in general exhibits the same kind of properties found in other assimilation types.

### 8.5.5 The larger picture

This section focused on five cases of consonant harmony. I demonstrated that consonant harmony constitutes a type of parasitic assimilation. This makes it clearly related to parasitic rounding harmony discussed in sections 8–8.4. In this section, I first review the potential differences between the two types of parasitic assimilation. It turns out that only some are actually valid. Next, I compare the

current approach to parasitic assimilation to an alternative approach which is not based on spreading.

### Different treatment of parasitic assimilation

Spreading of one feature is parasitic when it is dependent on the similarity between the trigger and the target. This is the case for both parasitic vowel harmony and consonant harmony. Despite this rather fundamental similarity between the phenomena, their treatment in the phonological literature is very different. In this section, I try to answer where this disparity comes from and why it is misleading. I provide four such examples.

First, the main reason for different treatment of the phenomena is historical. On the one hand, parasitic vowel harmony has been known at least since the 1970s. On the other hand, consonant harmony has been largely unknown until the 1990s, with the two most important typological studies—Hansson 2001 and Rose & Walker 2004—conducted only within the last ten years. This is why parasitic vowel harmony has been considered a well-established phenomenon with specific representational solutions pertaining to the time in which it received most attention (e.g. Archangeli 1985). Consonant harmony has remained largely free of representational accounts. In particular, the feature spreading approach has not been truly systematically considered for consonant harmony (see Odden 1994 for a treatment of consonant harmony in the context of a general theory of assimilation). In this chapter, I have shown that both phenomena can be dealt with in a unified framework that combines autosegmental representations with OT constraints.

Second, there appear to be profound locality disparities between vowel and consonant harmony. More specifically, consonant harmony seems to often spread over other consonants, whereas vowel harmony does not spread over other vowels. However, this difference is only an illusion. To start with, it is not true that vowel features do not spread across other vowels. We have seen several extreme examples of this: [open] can spread over a string of several vowels, as in c'Lela (section 5.4). Another case of this would be tongue root harmony in Menomini (Bloomfield 1962, 1975; Cole 1987; Cole & Trigo 1988; Archangeli & Pulleyblank 1994; Archangeli & Suzuki 1997a; Milligan 2000; Archangeli & Pulleyblank 2007). In this language, [ATR] spreads from high vowels to other high vowels. Only long vowels are targeted, skipping any string of lax (low or high) vowels. This is independent of the fact that the language has tongue root contrast in both high and low vowels.

Upon closer examination, the real contrast seems to be that vowel harmony *usually* does not skip other vowels, whereas consonant harmony does. However, the problem is that consonant harmony is defined as spreading from one consonant to another by skipping vowels. In other words, while there are parasitic phenom-

ena in spreading from one consonant to another, only some of them also involve skipping vowels. Others do not. For example, Slovenian has regressive posterior spreading within sibilants that is obligatory when the trigger and the target are strictly adjacent (cf. [s̥-tsen-o] ‘with-price-INSTR’ vs. [ʃ-tʃet-o] ‘with-troop-INSTR’), but optional when spreading applies across other segments (cf. [ʃ-preʒ-o] ~ [s̥-preʒ-o] ‘with-lurking-INSTR’), all within an intonational phrase. This strongly suggests that the difference in locality between vowel and consonant harmony is definitional. Parasitic assimilation—vocalic and consonantal alike—can apply between a trigger and a target that are strictly adjacent to one another or not (Burzio 2005). This contrasts with non-parasitic assimilation which applies to one or more natural classes of segments (that each have a particular feature in common). In the current model, non-parasitic harmony presents the general type attributed to alignment constraints. Parasitic harmony, on the other hand, requires a high ranked agreement constraint. Agreement constraints prefer spreading to a subset of all targets of alignment constraints.<sup>14</sup> More broadly speaking, no segment is invariantly transparent. Transparency is a possible representational situation, which is determined by constraints. Since these can be ranked differently, some segments may be transparent in some contexts, but not in others.

Third, Hansson (2001:213,214), Rose & Walker (2004:486,487) observe that blocking in consonant harmony is exceedingly rare. Hansson’s argument is based on the following two premises: (i) segmental blocking is common in vowel and nasal harmony and (ii) no cases of failed spreading in consonant harmony can be attributed to segmental blocking. I now examine both in more detail.

We have seen that segmental blockers are quite common in nasal harmony (section 6.6.1). However, we have also seen that the reported cases of consonantal blocking of vowel harmony are very rare (section 6.5.1). More explicitly, there are very few reported languages in which only some consonants block vowel harmony. This is particularly troubling since vowel harmony is cross-linguistically quite frequent and well studied (compared to consonant harmony). One way of grounding blocking is saying that it is due to incompatibility of the spreading feature with some feature of the blocker (Walker 1998/2000). Because most vocalic features rarely spread to consonants (other than strictly adjacently), we would expect that all consonant features act the same with respect to vocalic features: they all either block spreading (harmony to adjacent consonants) or not (total harmony). Both of these patterns are attested: the former falls within local consonant assimilation, while the latter is found in consonant harmony.

The pattern we do not see is that only some vowels block consonant harmony, while others do not. This is the crucial point that could distinguish blocking

---

<sup>14</sup>For a similar idea on the two types of assimilation, but a rather different analysis, see Wayment (2009).



in consonant versus vowel harmony. To the best of my knowledge, there is no example of consonant harmony blocked by some vowels but not by others. Yet this claim becomes more problematic if we consider that blocking is possible to identify beyond doubt only when spreading is supported by active alternations. Of the 123 cases of consonant harmony reviewed in Hansson (2001), 51 show only static co-occurrence restrictions, but no alternations. Alternations are found in the remaining 72 languages. This is a very small number compared to the number of known vowel harmony cases. Consonant blocking is very infrequent in vowel harmony, and there is no reason to assume that vowel blocking in consonant harmony is, relatively speaking, any more frequent. The sample size difference, however, suggests that the number of known consonant harmony cases is too small to find even a single case of blocking by vowels, even if such a language exists.

The remaining issue is blocking of consonant harmony by consonants. We have seen three such cases in this thesis. Recall Nati retroflexion in Sanskrit, discussed in section 4.4. The pattern involves spreading from coronal continuants to nasals. However, other coronals block spreading. This is an obvious challenge to the claim that consonant harmony lacks blocking, and Hansson (2001) responds simply by stipulating that Nati is not a case of consonant harmony, since it does not exhibit parasitic properties. In the current approach, coronal harmony is enforced by alignment that has [coronal] as the targeted structure. Nati is a case of consonant harmony without apparent parasitism beyond its restriction to coronals.<sup>15</sup>

Another case of blocking is found in Koyra sibilant harmony. Recall that in this language, spreading of posteriority is blocked by any consonant. In response to these data, Hansson (2001) and Rose & Walker (2004) claim that the trigger and the target in Koyra can be separated by at most one vowel, which is a restriction on proximity. However, this generalization is empirically equivalent to the alternative, which is that consonants block spreading. This is because Koyra lacks data which would distinguish blocking by consonants from the restriction on proximity. In particular, there is no hiatus. The blocking approach would predict spreading across a sequence of two vowels. The alternative proposed by Hansson (2001) and Rose & Walker (2004) would predict the opposite. We can conclude that the Koyra data do not give definite evidence for either blocking or a restriction on proximity. The final case of blocking is Slovenian sibilant harmony. Although these data present only variant pronunciation, it is clear that only a subset of all possible variants is found. In particular, in no case can spreading apply across coronal stops. We can conclude that there is not enough evidence to support the claim that vowel and consonant harmonies differ in terms of blocking.

---

<sup>15</sup>An alternative analysis of Nati and other cases of sibilant and coronal harmony is also possible by using the alignment constraint  $*\Phi([\text{retroflex}], \times)$  with the root node as the targeted structure, complemented by the high ranked agreement constraint  $\text{AGREE}([\text{retroflex}], \text{coronal})$ . These two constraints effectively limit retroflex harmony to coronals.

The fourth and final difference between vowel and consonant harmony concerns failing triggers. Recall section 8.5.4 and Yaka nasal consonant harmony. Nasality spreads from nasal sonorants and targets voiced sonorants. The interesting bit about this pattern is that prenasalized stops do not trigger harmony and appear to be skipped by consonant harmony. This leads Rose & Walker (2004) and Rose (2004) to conclude that consonant harmony does not involve skipping, but instead agreement between the trigger and the target. However, there are two possible alternatives which lead to a different conclusion. One could say that prenasalized stops are not [nasal]. Instead, nasality is a side-effect of voicing, or its phonetic implementation, but not a part of phonological computation (see Durvasula 2009 for a proposal along these lines). This would require a substantial modification of feature theory (see Morén 2003, 2006b, 2007b; Blaho 2008; Hale & Reiss 2008; Dresher 2009; Mackenzie 2009 for proposals). An alternative is to say that prenasalized stops are regular targets, but do not trigger nasalization themselves. The advantage of this view is a unification across assimilation types. Failing triggers are also found in vowel and regular nasal harmony. For instance, nasal sonorant stops do not trigger nasalization in some languages, but propagate nasality when triggered by another segment. Yet no one would claim that these nasals are skipped in regular nasal harmony, which also suggests that there is no reason to assume skipping in nasal consonant harmony. In light of these facts, we can conclude that nasal harmony and nasal consonant harmony can be analyzed using a single approach. In the current framework, failing triggers are predicted by constraints on Heads-of-Heads.

These examples suggest that the differences between consonant and parasitic vowel harmony is not as radical as assumed in the literature.

### Differences in parasitic assimilation

As we have just seen, consonant harmony and (parasitic) vowel harmony turn out not to be as divergent as previously assumed. Nevertheless, at least two disparities between the two phenomena remain.

First, vowel harmony is predominantly non-parasitic, whereas consonant harmony is predominantly parasitic. Note that these are tendencies rather than absolute generalizations without exceptions. That is, there are both cases of parasitic vowel harmony (including Yowlumne and Kachin Khakass) and non-parasitic consonant harmony (as in Sanskrit). Furthermore, some vowel harmony patterns are ambiguous as to whether they are parasitic or not. Consider Wolof RTR harmony discussed in section 3.2.3. In Wolof, [rtr] spreads from open vowels to other open vowels, whereas high vowels are not affected. One option is to analyze this pattern as non-parasitic. The opposite view is that harmony is parasitic. That is, [rtr] spreads if both the trigger and the target agree in terms of the feature [open]. The

fact that high vowels do not trigger harmony is a separate restriction. The pattern is directly parallel to Kachin Khakass where rounding spreads from high vowels to other high vowels, whereas open vowels are not affected and fail to trigger harmony. This suggests that some patterns can be analyzed as both parasitic and non-parasitic.

The remaining question is whether consonant harmony also exhibits the same properties. Are there any cases of consonant harmony that are solely non-parasitic? From the cases reviewed in this section and elsewhere in this thesis, we can conclude that the answer is no. That is, even if we assume that Nati constitutes the best case for non-parasitic consonant harmony, it still contains some parasitism. Namely, retroflexion spreads within coronals. This indicates that consonant harmony is always parasitic, whereas vowel harmony can be or not. In the current framework this can be attributed to the targeted structure of alignment constraints, which are usually vowels, and not consonants.

The second property which sets consonant harmony apart from other patterns is its restriction on what features can spread. I have analyzed sibilant harmony, retroflex harmony, and nasal harmony. Other patterns include interacting liquids, alternations in laryngeal features and secondary place features. Crucially, there is no convincing case of primary place consonant harmony (Hansson 2001). In section 3.3.1, I proposed an account for this gap such that alignment constraints with primary place features as spreading features can have vowels, but not consonants, as targeted structures. If so, then primary place consonant harmony across vowels is not predicted by the alignment constraint typology. In this chapter, I introduced agreement constraints. These can refer to other targeted structures. Consider, for example, the constraint  $\text{AGREE}([\text{labial}], \text{consonant})$ . This constraint would prefer consonant harmony across vowels, which is an unattested pattern. One response to these facts would be to restrict the inventory of possible agreement constraints. That is, a consonant cannot be the targeted structure of an agreement constraint. By extension, a vowel cannot be either, but the evidence for that is much less compelling, since vowel harmony is an attested pattern. Another argument for this restriction is that vowels and consonants are not phonological features in most frameworks. This allows for a distinction between agreement and alignment constraints. In alignment constraints, targeted structures can be phonological objects—such as root nodes, vowels and consonants—or phonological features. In agreement constraints, on the other hand, targeted structures are always features, but never other objects (including root nodes, vowels, consonants, prosodic and morphological domains). In short, agreement constraints always refer to two features, and never to any other structure. This differs fundamentally from alignment constraints where there is no such restriction. If so, then primary place

consonant harmony cannot be generated by agreement constraints either. I leave the particulars of this proposal to further research.

In summary, consonant harmony is directly comparable to vowel harmony in general, and parasitic vowel harmony specifically. Both have directly comparable locality, parasitic, blocking and triggering properties. The difference between the two phenomena stems from the preference of most features to spread to vowels, rather than consonants.

### **Against Agreement by Correspondence**

This thesis is a theory of assimilation as feature spreading in OT. I have demonstrated that this approach can capture all sorts of assimilation as well as other patterns. This includes parasitic vowel harmony and consonant harmony. Now I shortly discuss one prominent recent alternative—Agreement by Correspondence (Hansson 2001; Rose & Walker 2004, *et seq.*; henceforth, ABC). This approach can deal with many cases of assimilation in which similarity between the trigger and the target matter. However, this approach cannot account patterns in which triggers and targets must be dissimilar. This includes failed triggers and icy targets.

ABC is an approach to assimilation that has been developed specifically for consonant harmony (and has been since extended to other kinds of assimilation). The main idea is that consonant harmony is due to long-distance consonant agreement. This is formalized in terms of output correspondence relations between triggers and targets. Without going into too much detail, I now outline a few predictions of ABC.

First, the difference between blockers and transparent segments needs a very different explanation. In the original proposal (Hansson 2001:213,214; Rose & Walker 2004:486,487) it was suggested that the segments that are not affected by assimilation must be transparent. This is because blocking has been considered only in terms of spreading. Since agreement involves no spreading, there should be no blocking. This has since been falsified. Hansson (2007a) shows that feature co-occurrence constraint can have a similar effect in an ABC-based approach. This is a good prediction, since several cases of segmental blocking in consonant harmony have been reported (including Sanskrit, Koyra, Slovenian, and Kinyarwanda).

Second, the locality restriction of ABC are quite different than the ones found in spreading. In particular, two segments can agree even if there is an intermediate segment with the same feature. This is relevant to the pattern found in Yaka nasal consonant harmony (section 8.5.4). Recall that Yaka has spreading of nasality from a nasal sonorant stop to voiced consonants. Prenasalized stops do not trigger harmony in Yaka, and they do not interfere with spreading from a different trigger.

On the surface it appears that nasality spreads to a target while skipping the prenasalized stop.

Third, ABC predicts that all long-distance assimilations are parasitic in the sense that the trigger and the target must be identical in terms of some other feature (or a combination of features), whereas they remain agnostic about strictly local assimilation. This rules out non-parasitic consonant harmony. In short, ABC perfectly captures consonant harmony. It can even account for most cases of local assimilation. There is nothing in the theory that would rule out nasal and vowel harmony, local consonant assimilation and tone spreading.

The case against ABC comes from three sources, which will now be reviewed in detail. ABC is based on the assumption that spreading cannot deal with consonant harmony. While that might be true for the classic approach to feature spreading, it is not the case that consonant harmony is ruled out by spreading per se. This chapter provides an example. I specifically argue that BDT in combination with OT constraints can deal with all cases of consonant harmony. What is worse, even the cases that are supposed to provide a compelling argument for agreement (Rose & Walker 2004:514) can be analyzed as spreading. For example, prenasalized stops in Yaka are examples of failing triggers, which are also found in Baiyinna Orochen rounding harmony and Mòbà nasal harmony. These other two patterns provide no argument for ABC, hence there is no reason that Yaka does either.

The second argument concerns the trigger–target disparities. Assimilation is sometimes triggered by a segment that is *different* from the targets. For example, a consonant may affect a vowel but not other consonants—as in Serbo-Croatian (56). This can happen even if a trigger and its targets are not adjacent. For example, faucal harmony in Sñchitsuʔumshtsn is triggered by a set of consonants that target non-high vowels (Bessell 1998). Similarly, progressive emphasis spread in Northern Palestinian Arabic (Davis 1995) targets the low vowel, but can skip other consonants. Chilcotin flattening is triggered by consonants that target vowels, whether adjacent or not (Cook 1976, 1983, 1987, 1993). ABC specifically rules these patterns out, because they are long-distance and non-parasitic. The current approach based on feature spreading can account for these patterns. What is common to all these patterns is that all targets form a natural class that can be defined using features. These features are the targeted structures of alignment constraints.

ABC also fails to account for icy targets. We have seen an example of icy targets in consonant harmony. In Nati, retroflexion can spread to coronal non-continuants, but it cannot spread from them. One possible response is to argue that Nati is not a case of consonant harmony (Hansson 2001; see section 4.4.2 for further discussion). However, the question whether Nati is consonant harmony (or not) is irrelevant, what matters is that ABC rules out such patterns. Nati is

assimilation and can be captured in the current approach. The same goes to other cases of icy targets.

We have just seen that ABC can capture only a subset of all assimilation patterns, which means it still requires a spreading account. The current approach, on the other hand, can capture the same patterns based on spreading alone. This means that the current model is more parsimonious. Consequently, ABC needs to be rejected.

## 8.6 Summary

This section examined patterns in which the hierarchy of feature spreading is obscured by another factor—parasitism. In some cases of assimilation, spreading of one feature is dependent on another feature. The empirical contribution is that the cases of parasitic vowel harmony are directly comparable to consonant harmony. The theoretical contribution is that parasitic assimilation gives evidence for a special class of constraints.

Parasitic vowel harmony is demonstrated on the typology of rounding harmony. The prototypical case of symmetrical vowel harmony is Yowlumne in which rounding spreads when the trigger and the target are of the same height. Other languages exhibit a subset of the Yowlumne pattern. For example, Kachin Khakass requires the trigger and the target to be high vowels. Yakut presents an intermediate pattern in which parasitism is limited to high vowels, while non-high vowels show non-parasitic spreading.

Consonant harmony resembles parasitic vowel harmony in many ways. In the most general terms, both patterns involve spreading of one feature dependent on another feature. Consonant harmony generally does not involve vowels, just as vowel harmony does not involve consonants. Consonant harmony exhibits other phenomena found in assimilation: directionality, restrictions within domains, blocking, transparency, and restrictions on triggers.

Parasitic assimilation provides evidence for a new class of constraints, which require agreement between two features. I take a well known constraint family—agreement. I propose of a modification of agreement, such that reference to two features but no adjacency is required. Agreement constraints work in combination with alignment. In particular, agreement constraints restrict spreading to or within a subset of segments targeted by a lower ranked alignment constraint. Depending on the ranking of feature co-occurrence constraints, agreement constraints can cause skipping of some targets in some languages, but not in others. All these options are attested in parasitic vowel harmony, local parasitic consonant spreading and consonant harmony.

Finally, there is also one crucial difference between vowel harmony and consonant harmony. Most notably, consonant harmony is generally always parasitic, whereas vowel harmony may or may not be. In the current model, this disparity follows from the typology of alignment constraints. Specifically, the targeted structures of most alignment constraints are root nodes or vowels, but not consonants. This predicts non-parasitic patterns like nasal or vowel harmony, but rules out non-parasitic consonant harmony.





# Chapter 9

## Positional effects

In this final chapter, I focus on another frequent pattern in assimilation. In particular, I look at data which show feature spreading in some positions, but delinking in all others. This pattern differs from regular assimilation which involves only spreading, and dissimilation which involves only delinking. In chapter 3, I have shown that alignment constraints can capture both assimilatory and dissimilatory patterns. Hence, it makes sense to use the same approach when discussing the positional effects in this chapter. What sets these cases apart from the other two phenomena is a separate preferential treatment of certain phonotactic, prosodic or morphological positions. Segments in these positions are protected and never exhibit alternations, whereas all other positions are subject to alternations.

Prominent positions are protected by a high ranked constraint. This is a faithfulness constraint that trumps the effects of alignment constraints. I will take on a well-established approach of Positional Faithfulness (Beckman 1997, 1998). The idea behind this approach is that prominent positions are protected by specific, high ranked faithfulness constraints. According to Beckman (1998), positional faithfulness applies to onsets of syllables, initial syllables, stressed syllables, and roots. I make two modifications. First, I argue that the positional faithfulness should be penalized only by delinking, but not by linking. Second, I propose that positional faithfulness needs to be extended to the rightmost segment within a prosodic or morphological domain.

This chapter is organized as follows. I begin by looking at a typical example of positional effects in voicing assimilation (section 9.1). This pattern requires a constraint that has not been used in this thesis. Positional faithfulness is introduced in section 9.2. I propose that this well-established approach be modified. More specifically, I argue that MAXLINK[f] should be made specific to a particular position. This means that positional faithfulness constraints are penalized by delinking, but not by spreading. Section 9.3 demonstrates the approach on voicing assimilation in Hungarian. This type of assimilation is chosen because it

shows the effects of several positional faithfulness constraints. Under the current view, languages with voicing assimilation and final devoicing are predicted to be the simple case, whereas languages without final devoicing require an additional positional faithfulness constraint. Section 9.4 extends positional faithfulness from absolutely final positions to the positions closest to the right edge of a domain. In section 9.5, I discuss positional faithfulness to roots. Section 9.6 concludes.

## 9.1 Introduction

The cases of assimilation examined so far appear to involve a relatively easily identifiable trigger, a spreading feature and targets. Triggers spread the relevant feature to a natural class of targets. In this chapter, I focus on alternations where the relationship between triggers, the spreading feature and targets is not as simple. What seems to matter is a particular prosodic, phonotactic or morphological position. If such a position is associated with the spreading feature, all other targets will also be. If the position is not associated with the spreading feature, no other targets can be. These restrictions on alternations are directly relevant to any theory of assimilation. The pattern involves spreading from a prominent position and delinking elsewhere.

Let us look at a prototypical example. Recall Russian voicing alternations in section 2.1. Like Russian, Hungarian also exhibits voicing alternations within obstruent clusters (Vago 1980b; Abondolo 1988; Siptár & Törkenczy 2000; Petrova & Szentgyörgyi 2004; Petrova et al. 2006; Blaho 2002, 2008). The Hungarian data in (288) show that obstruent clusters always agree in voicing. Obstruent voicing is always preserved in the position immediately preceding a vowel (288-a) or a sonorant (b). In contrast, obstruents alternate when followed by another obstruent. Only voiced obstruents are possible immediately before a voiced obstruent (c), and only voiceless obstruents are allowed before a voiceless obstruent (d).

- (288) Hungarian voicing assimilation (Siptár & Törkenczy 2000:78; Kata Tamási, Éva Dékány, p.c.)
- |    |           |             |         |
|----|-----------|-------------|---------|
| a. | vi:z-ek   | lɔka:f-ok   | ‘PL’    |
| b. | vi:z-nɛk  | lɔka:f-nɔk  | ‘DAT’   |
| c. | vi:z-bɛn  | lɔka:ɓ-bɔn  | ‘INESS’ |
| d. | vi:s-tø:l | lɔka:f-to:l | ‘ABL’   |
|    | ‘water’   | ‘flat’      |         |

This pattern is unlike anything analyzed in this thesis so far. In particular, what we see in Hungarian is voicing of obstruents before another voiced obstruent, but devoicing before a voiceless obstruent.

This pattern can be analyzed in terms of the feature [voice].<sup>1</sup> However, the Hungarian situation is not simply spreading of this feature. Instead, Hungarian involves both spreading and delinking. When the rightmost obstruent in a cluster has [voice], we see spreading to the preceding obstruent. When the rightmost obstruent lacks [voice], we see delinking of this feature from the preceding obstruent. In short, [voice] spreads from some positions, but delinks from others.

In the light of numerous cases of assimilation examined in the previous chapters, the Hungarian voicing alternations are somewhat surprising. Why would a feature spread in some cases, but delink in others? We would normally expect that a feature spreads in all cases, or in none. Yet such a pattern is attested—and rather frequent, which requires an account.

One option is to attribute the Hungarian pattern to previously discussed constraints. The constraints used so far are of five types: (i) alignment constraints, (ii) faithfulness constraints, (iii) feature co-occurrence constraints, (iv) constraints on heads and Heads-of-Heads, and (v) agreement constraints. Each of these constraints can be made specific to Hungarian voicing assimilation, as in (289). First, in Hungarian [voice] spreads or delinks. We have already seen that alignment constraints can deal with either assimilation or dissimilation (section 3.3). If so, then the Hungarian pattern might also involve alignment constraints. Alignment constraints consist of one spreading feature, one targeted feature and a domain. For now, I limit the discussion to assimilation within a prosodic word. One possible alignment constraint is  $*\omega([\text{voice}], \times)$ . Another constraint has reversed a f-precedence relation:  $*\omega(\times, [\text{voice}])$ .<sup>2</sup> Second, voicing assimilation involves linking and delinking of [voice], which potentially violate  $\text{DEPLINK}[\text{voice}]$  and  $\text{MAXLINK}[\text{voice}]$ . Third, the relevant feature co-occurrence constraint prohibits voiced obstruents:  $*[\text{voice obstruent}]$ . Fourth, the constraints on heads may effectively stop spreading. The constraint  $*[\text{VOICE obstruent}]$  prefers no spreading from voiced obstruents. I will consider only combinations of one trigger and one target, hence the effect of constraints on Heads-of-Heads (section 7.2) is identical to the constraint on heads. Finally, obstruent clusters in Hungarian always agree in voicing. One way of capturing this generalization is by using an agreement constraint  $\text{AGREE}([\text{voice}], \text{obstruent})$ . This constraint prefers spreading of the feature [voice] only if both the trigger and the target are obstruents.

---

<sup>1</sup>For arguments for privative, rather than binary, [voice] see section 2.2.1.

<sup>2</sup>Other alignment constraints that have [voice] as the spreading feature are not required. This is because [voice] rarely spreads across segments. Crucially, voicing assimilation never spreads across vowels (section 8.5.1).

- (289) Potentially relevant constraints in Hungarian
- a. Alignment constraints (sections 2.2.2, 3.2.4, 5.2.2)  
 $*\omega([\text{voice}], \times)$   
 $*\omega(\times, [\text{voice}])$
  - b. Faithfulness constraints (sections 2.2.2, 5.2.2)  
 DEPLINK[voice]  
 MAXLINK[voice]
  - c. Feature co-occurrence constraints (sections 4.2.4, 6.2.1)  
 $*[\text{voice obstruent}]$
  - d. Constraints on heads (sections 4.2.4, 5.2.2, 7.2)  
 $*[\text{VOICE obstruent}]$
  - e. Agreement constraints (section 8.2.2)  
 AGREE([voice], obstruent)

The constraints in (289) may be able to account for the Hungarian voicing assimilation. In testing whether this is true, I limit the discussion to forms containing a single onset obstruent or a cluster of maximally two obstruents. Furthermore, I discuss only a small subset of all possible candidates. If no ranking works for these candidates, it will certainly not work for a larger set of candidates. As we have seen in the discussion of parasitic phenomena in sections 8.1 and 8.5.3, the simplest way to compare a number of candidates is by using a comparative tableau, as in (290). Inputs are marked by /in/, and are not presented in a separate column. Association lines represent full association, while dependent association to transparent segments is left out. In addition, only contrastive [voice] is shown. Other instances of [voice] are ignored, since they do not affect the outcome of evaluation.

Candidates (a) and (b) have no obstruent clusters, and obstruents always surface faithfully. Candidate (c) is a case of spreading to the preceding obstruent, while candidate (d) represents delinking from the coda obstruent. What is evident from the tableau below is that no constraint prefers only winners. This means that the attested candidates cannot win under any ranking.

## (290) Inconsistency in Hungarian

| Winner ~ Loser /Input/                                                      | *[VOI obs] | *[voi obs] | AGREE([voi], obs) | * $\omega$ ([voi], $\times$ ) | * $\omega$ ( $\times$ , [voi]) | MAXLINK[voi] | DEPLINK[voi] |
|-----------------------------------------------------------------------------|------------|------------|-------------------|-------------------------------|--------------------------------|--------------|--------------|
| a. /in/ lɒk a: f o k ~ lɒk a: $\underset{[v]}{ʒ}$ o k                       |            | W          |                   | W                             | W                              |              | W            |
| b. /in/ v i $\underset{[v]}{z}$ ε k ~ v i s ε k                             |            | L          |                   | L                             | L                              | W            |              |
| c. lɒk a: $\underset{[v]}{ʒ}$ b ɒ n ~ lɒk a: f $\underset{[v]}{b}$ ɒ n /in/ | L          | L          |                   |                               | W                              |              | L            |
| ~ lɒk a: f p ɒ n                                                            | L          | L          |                   | L                             | L                              | W            | L            |
| d. v i: s t ø: l ~ v i: $\underset{[v]}{z}$ t ø: l /in/                     | W          | W          |                   | W                             | W                              | L            |              |
| ~ v i: $\underset{[v]}{z}$ d ø: l                                           | W          | W          |                   | W                             | W                              | L            | W            |

We can conclude that none of the previously proposed constraints can deal with Hungarian voicing assimilation. This challenge provides motivation for another constraint. It turns out that there is already an existing proposal that can deal with the Hungarian pattern. This solution comes in the form of Positional Faithfulness (Beckman 1997, 1998). The idea behind this approach is that prominent positions—such as roots, onsets, stressed or initial syllables—are immune to the effects of some markedness constraint. More specifically, the faithfulness constraints that refer to these positions can outrank markedness constraints and general faithfulness. In the current context, the markedness constraints are alignment constraints, which require that a feature is aligned with a domain edge. In Hungarian, alignment prefers spreading of [voice] to the edge of a prosodic word. However, because [voice] cannot spread across vowels, the alignment constraint is always violated, unless [voice] originates from a segment close to the edge. Another way of satisfying an alignment constraint is delinking, as previously demonstrated for dissimilation in section 3.3.2. Because spreading of the feature [voice] to adjacent obstruents but not across vowels generally cannot satisfy alignment, delinking is preferred instead, which vacuously satisfies alignment. Yet when the

feature is linked to a segment in pre-nasal position, a positional faithfulness constraint preserves the input association. In addition, the alignment constraint prefers spreading of [voice] to the preceding coda. This results in a pattern with spreading preferred in some cases, but delinking preferred in other cases. In what follows, I demonstrate these and other effects of positional faithfulness.

## 9.2 Positional faithfulness

Hierarchy is one of the core properties of all human languages. One ramification of hierarchy is the distinction between more and less prominent constituents (e.g. Liberman & Prince 1977; Hayes 1995; de Lacy 2006). With respect to assimilation, we have already seen evidence that some segments (heads) are more prominent than others (non-heads). Positional effects reveal another type of prominence. In particular, some prosodic/morphological positions are resistant to the influence of alignment constraints. For instance, if a prominent position does not contain a spreading feature underlyingly, it will not acquire it due to a markedness constraint that prefers spreading. Such resistance to effects of markedness constraints can be restated in terms of faithfulness. Namely, prominent positions are more faithful than non-prominent positions, which suggests that there are specific faithfulness constraints that apply only to prominent positions. If these faithfulness constraints are ranked above markedness constraints, the prominent positions are exempt from the effects of markedness constraints.

Faithfulness constraints specific to prominent positions have been developed by Beckman (1997, 1998) and are known as Positional Faithfulness. Formally, these constraints are faithfulness constraints that refer to a particular (prosodic, morphological or phonotactic) position. We have already seen one such constraint in (145). In (291), I give this constraint with an abstract feature. The positional faithfulness constraint in (291-b) is a positional variant of the general IDENT(f) constraint (291-a).

- (291) General faithfulness and positional faithfulness (Beckman 1997:7)
- a. IDENT(f)  
Correspondent segments in output and input have identical values for the feature [f].
  - b. IDENT-*Position*(f)  
A segment in *Position* in the output and its correspondent in the input must have identical values for the feature [f].

Two observations regarding the constraint template in (291) are needed. The first concerns the general faithfulness constraint IDENT(f). Identity constraints have

at least two different definitions. The original definition proposed in McCarthy & Prince (1995, 1999) assigns a violation mark if and only if the input segment has [+f], while its output correspondent does not. This means that if the input does not contain [+f], the constraint is always vacuously satisfied. As pointed out by Blaho (2008:45ff.), this version of the constraint has the same predictions as MAX[(+)f], particularly if one assumes that features are not directly associated with one another (as is the case in the current approach). In autosegmental terms, the original IDENT(f) is violated only by the delinking of [+f], but not by linking. The definition in (291-a), on the other hand, differs in that it penalizes both delinking and linking.

Second, the definition of IDENT(f) is violated by two disjunctive configurations: (i) if the input root node  $\times_i$  is linked to [f], while its output correspondent  $\times_o$  is not, and (ii) if  $\times_i$  is not linked to [f], while  $\times_o$  is. The concept of identity (“are not identical”) unifies the disjunctive condition into a single concept. Identity refers to the relationship between a feature and a root node, which must be maintained in the input and output. Nowhere in this thesis have I used identity, and introducing it here seems unwarranted.<sup>3</sup> What I propose instead is to use primitives that are more consistent with the rest of the approach. In this thesis, I only used two kinds of faithfulness constraints: DEPLINK[f] and MAXLINK[f]. The classic positional faithfulness constraints seem to combine the effect of both constraints, specific to a particular position. However, once the effect of alignment constraints is taken into consideration, positional MAXLINK[f] is entirely sufficient. This makes positional MAXLINK[f] similar to the original definition of IDENT(f) (McCarthy & Prince 1995, 1999).

The effect can be described as follows. To start with, one way of satisfying alignment constraints is by delinking. Recall the discussion of dissimilation in section 3.3.2, where it was shown that delinking will be preferred only if general MAXLINK[f] is ranked below the alignment constraint. However, where there is another, position specific instance of MAXLINK[f] ranked above the alignment constraint, that position cannot delink. Instead, the association line is preserved, and alignment prefers spreading to all other positions. This is exactly what is required in an analysis of positional effects.

To formalize the positional variant of MAXLINK[f], I start of with the general definition, which was first given in (64) and is adapted to full association below.

(292) MAXLINK[f]

Let  $\times_i$  be an input root node and  $\times_o$  its output correspondent. Assign a violation mark, iff  $\times_i$  is fully associated with the feature [f] and  $\times_o$  is not.

---

<sup>3</sup>For other arguments against IDENT(f) constraints see Blaho (2008).

The faithfulness constraint  $\text{MAXLINK}[f]$  can be easily made specific to a particular position, as in (293).

- (293)  $\text{MAXLINK-Position}[f]$   
 Let  $\times_i$  be an input root node and  $\times_o$  its output correspondent.  
 Assign a violation mark, iff
- (i)  $\times_o$  is in *Position*  
     and
  - (ii)  $\times_i$  is fully associated with the feature  $[f]$  and  $\times_o$  is not.

The main advantage of the constraint definition in (293) is that it is not disjunctive, which is not the case for Beckman's original proposal. Another advantage is that  $\text{MAXLINK-Position}[f]$  fills the gap in the typology of alignment constraints. In chapter 3, we have seen that alignment can interact with faithfulness constraints. When alignment is outranked by  $\text{MAXLINK}[f]$ , assimilation prevails. When the ranking is the opposite, dissimilation is preferred instead.  $\text{MAXLINK-Position}[f]$  refers to a subset of all triggers and thus presents an intermediate situation. The resulting pattern involves a positional effect.

The remaining question is what are the universally possible prominent positions that constraints can make reference to. As a case study, I proceed by reviewing positional faithfulness constraints relevant to voicing assimilation in Hungarian.

### 9.3 Hungarian

We have seen that the constraints introduced so far are not adequate to account for voicing assimilation (section 9.1). In response to this, I introduced positional faithfulness constraints (section 9.2). I now revisit Hungarian voicing assimilation. The general faithfulness constraint in voicing assimilation is  $\text{MAXLINK}[\text{voice}]$ . The remaining task is to complement this constraint with the correct position. As we will see, this has to be done in two steps. I first account for word-medial obstruent clusters. Then I move to word-final clusters.

Recall the Hungarian voicing assimilation data in (288). To recap, voicing of an obstruent cluster is determined by the rightmost obstruent. Within a cluster, voiced obstruents are always preceded by voiced obstruents, whereas voiceless obstruents are preceded by voiceless obstruents.

Two positional faithfulness constraints appear to be sufficient to account for the Hungarian voicing assimilation facts. First, the rightmost obstruent in a cluster is always in the onset of the following syllable. The most obvious solution to analyze these data is a positional faithfulness constraint that refers to onsets, as proposed for other languages with voicing assimilation by Lombardi (1999). Such an approach follows from the fact that onsets are more prominent than codas. One



reason for that are the asymmetries between onsets and codas: many languages do not allow codas, but all languages allow onsets (for further discussion see Lombardi 1999:270–271).

An alternative solution would be to say that the relevant faithfulness constraint is specific to a presonorant position (Petrova & Szentgyörgyi 2004; Petrova et al. 2006; Blaho 2002, 2008; Rubach 2008). This proposal stems from speech perception. Obstruents in presonorant positions are perceptually more salient than obstruents in other positions (Steriade 2001, 2001/2008). Perceptual salience can be captured by special positional faithfulness constraints. Presonorant faithfulness constraints apply only to a subset of all onset obstruents, namely the ones in the position immediately before a sonorant.

For the most part, onset and presonorant faithfulness make the same predictions, because the sets of onset and presonorant obstruents are identical. That is, onsets contain only a single obstruent, which is also in the presonorant position. As pointed out by Petrova et al. (2006) and Rubach (2008), the difference between the two approaches becomes apparent when we consider those clusters that have more than one obstruent in the onset. The onset faithfulness approach would predict that such obstruents could have different facts than simple onsets. The presonorant faithfulness approach would predict that they cannot and that it is the rightmost obstruent that determines voicing or voicelessness of the cluster. It turns out that languages are consistent with this second generalization (see Rubach 2008 for further discussion). This is the reason I will make use of presonorant faithfulness. Presonorant faithfulness always preserves an association line to the segment immediately preceding a sonorant.

The presonorant faithfulness constraint MAXLINK-PRESONORANT[voice] is defined in (294). Note that this constraint has three—not two—conditions. The first and the second condition are required to formally define the position in terms of precedence and f-precedence relations.

- (294) MAXLINK-PRESONORANT[voice] (after Rubach 2008:439)  
 Let  $\times_i \mathfrak{R} \times_o$ .  
 Assign a violation mark, iff
- (i)  $\times_o \triangleleft$  [sonorant]  
 and
  - (ii)  $\nexists \times$ , such that  $\times_o < \times \triangleleft$  [sonorant]  
 and
  - (iii)  $\times_i$  is fully associated with [voice] and  $\times_o$  is not.

This constraint preserves voicing of the obstruent immediately preceding a sonorant. All other obstruents are subject to the effects of markedness constraints.

Voicing assimilation is driven by alignment constraints. The spreading feature is [voice]. The targeted structure is a root node. This has to do with the fact that no language shows spreading of [voice] across sonorants or vowels. One way to capture is to say that [obstruent] and [consonant] cannot be targeted structures of alignment constraints with [voice] as the spreading feature. The only other option is to say that all root nodes are targeted.

If the targeted structure is a root node, voicing assimilation should affect all segments. This predicts a pattern in which voicing spreads from a vowel to a consonant (or vice versa). Such cases are somewhat dubious. In particular, they all seem to be instances of lenition rather than assimilation. Lenition differs from assimilation in many ways. One property that sets the two apart is that lenition often requires two vocalic triggers, which affect the intermediate consonant. An example of this kind is intervocalic voicing of obstruents, which is a frequent pattern (see Kirchner 2001; Gurevich 2004; Kaplan 2010 for a review). The opposite pattern in which vowels devoice between two voiceless obstruents is also found in Japanese (McCawley 1968; Tsuchida 2001). In Slovenian, the glide [w] devoices when flanked by voiceless obstruents (Toporišič 1976/2000; Srebot Rejec 1981; Tivadar 1999). These attested patterns of intervocalic voicing and interobstruent devoicing on the one hand and lack of prevocalic voicing and preobstruent devoicing on the other suggest that voicing does not follow typical assimilation patterns, which require a single trigger (but see Myers 1997; Hyman 1998; Yip 2002 for analyses of such patterns involving tone and vowel height).

We can also conclude that voicing alternations can affect vowels and consonants. This suggests that there must be a common feature shared by sonorants and voiced obstruents. The other relevant pattern involves transparency. As we have seen in section 8.5.1, obstruent voicing never spreads across vowels. This might be due to the fact that vowels are themselves voiced or because they always block spreading. In the absence of further evidence, I remain agnostic about which of the two is a better solution. Either are possible under the current approach to (voicing) assimilation. If vowels are associated with the feature [voice], the lack of any interaction between obstruent clusters and vowels can be attributed to a positional faithfulness constraint specific to syllable nuclei. If vowels are not associated with the feature [voice], the blocking effect is because of a high ranked feature co-occurrence constraint \*[vowel voice]. In this latter case, the feature [voice] has the phonetic value of obstruent voicing.

We have now seen that a root node is a feasible targeted structure of an alignment constraint with [voice]. The remaining question is the domain. Recall the analysis in section 9.1, where I describe that voicing assimilation in Hungarian within words. It turns out that the voicing facts are the same within suffixed

words (295-a), compounds (b), and across word boundaries (c). In particular, obstruent clusters agree in voicing even across word boundaries.<sup>4</sup>

(295) Hungarian voicing assimilation (Blaho 2008:150)<sup>5</sup>

a. Suffixed forms

|              |            |                            |                |
|--------------|------------|----------------------------|----------------|
| k <u>u</u> t | ‘well’     | ku: <u>d</u> -b <u>o</u> n | ‘well.INESS’   |
| r <u>o</u> k | ‘put’      | r <u>o</u> g-d             | ‘put-IMP’      |
| r <u>o</u> b | ‘prisoner’ | r <u>o</u> p-to:l          | ‘prisoner.ABL’ |
| g <u>o</u> z | ‘weed’     | g <u>o</u> s-t             | ‘weed-ACC’     |

b. Compounds

|              |            |                                |                 |
|--------------|------------|--------------------------------|-----------------|
| z <u>o</u> b | ‘oat’      | z <u>o</u> p-ka:s <u>o</u>     | ‘oat mush’      |
| r <u>o</u> b | ‘prisoner’ | r <u>o</u> p-sol <u>g</u> o    | ‘slave’         |
| ha: <u>z</u> | ‘house’    | ha: <u>s</u> -t <u>o</u> rta:s | ‘household’     |
| vi: <u>z</u> | ‘water’    | vi: <u>s</u> -t <u>j</u> εp:   | ‘drop of water’ |

c. Across word boundaries

|               |         |                                                 |                  |
|---------------|---------|-------------------------------------------------|------------------|
| z <u>o</u> ld | ‘green’ | z <u>o</u> lt k <u>o</u> l <u>o</u> p           | ‘green hat’      |
| n <u>o</u> ŋ  | ‘big’   | n <u>o</u> c t: <u>e</u> :g <u>l</u> o          | ‘big brick’      |
| ki <u>ŋ</u>   | ‘small’ | ki: <u>z</u> g <u>o</u> mb <u>o</u>             | ‘small mushroom’ |
| h <u>o</u> t  | ‘six’   | h <u>o</u> d b <u>o</u> r <u>o</u> t <u>s</u> k | ‘six apricots’   |

What these data show is that the domain of assimilation is larger than the word. One option would be to say that assimilation applies in all domains. However, such a conclusion is contrary to the theory of assimilation developed in this thesis, which always requires a domain of application. We have also seen several other cases of assimilation applying across word boundaries. Recall the discussion regarding Somali tongue root harmony in section 2.1.3. In Somali, harmony applies across word boundaries. The crucial point is that it never applies across pauses. That is, the pauses are never random, but appear only in specific positions. These and other similar data can be taken as evidence that there is a domain of harmony, but it is larger than the prosodic word. I follow a rather

<sup>4</sup>In the spirit of full disclosure, it should be noted that some obstruents behave differently (see Siptár 1996; Siptár & Törkenczy 2000:78ff., Petrova & Szentgyörgyi 2004; Blaho 2008:163ff. for further details). For example, [v] undergoes devoicing, but never triggers voicing. In the current context, the failure to trigger voicing is a typical icy target behavior, which can be attributed to a constraint on heads of the feature [voice]. A full account of these exceptions would deter us from the main point of this section, which is to give an account of voicing assimilation at the right edge. The other wrinkle in the data concerns word-initial obstruent clusters. Sequences of two voiced obstruents are perfectly acceptable word-medially and word-finally. Word-initially, however, all obstruent clusters are voiceless. Furthermore, single obstruents in word-initial onset are not restricted with respect to voicing. These restrictions are not active alternations but only static patters. This issue is beyond the scope of this thesis.

<sup>5</sup>The IPA transcriptions are mine.

standard analysis by Nespor & Vogel (1986), who propose that the larger domain is an Intonational Phrase (IP), which is always flanked by pauses. The Somali situation is similar to Hungarian. Voicing assimilation applies in all positions except before a pause (see Markó et al. 2010 for details), that is, within an IP. Hence, IPs will serve as a domain of the alignment constraints active in Hungarian. I propose that two alignment constraints that differ only in terms of f-precedence relations— $*IP([\text{voice}], \times)$  and  $*IP(\times, [\text{voice}])$ —are ranked above the relevant faithfulness constraints— $DEPLINK[\text{voice}]$  and  $MAXLINK[\text{voice}]$ .

The effect of this ranking is shown in tableau (296). The same four candidates are considered as in tableau (290). No winners violate the positional faithfulness constraints. The remaining two competing forms in (c) and (d) show spreading from the onset and delinking from the coda, respectively, which is due to alignment constraints. Non-positional faithfulness constraints are linked lowest. If we look at the constraints in (296), all rows start with a W, which means that the ranking prefers winners to losers. The ranking is consistent and favors only winners. The ranking has the same effect regardless of the morpheme and word boundaries.

(296) Presonorant faithfulness accounts for Hungarian

| Winner ~ Loser /Input/                                                | MAXLINK-PRESON[voi] | *IP([voice], ×) | *IP(×, [voice]) | MAXLINK[voice] | DEPLINK[voice] |
|-----------------------------------------------------------------------|---------------------|-----------------|-----------------|----------------|----------------|
| a. /in/ lɒk a: f o k ~ lɒk a: <sup>[v]</sup> ʒ o k                    |                     | W               | W               |                | W              |
| b. /in/ v i <sup>[v]</sup> z ε k ~ v i s ε k                          | W                   | L               | L               | W              |                |
| c. lɒk a: <sup>[v]</sup> ʒ b ɒ n ~ lɒk a: f <sup>[v]</sup> b ɒ n /in/ |                     |                 | W               |                | L              |
| ~ lɒk a: f p ɒ n                                                      | W                   | L               | L               | W              | L              |
| d. v i: s t ø: l ~ v i: <sup>[v]</sup> z t ø: l /in/                  |                     | W               | W               | L              |                |
| ~ v i: <sup>[v]</sup> z d ø: l                                        |                     | W               | W               | L              | W              |

Presonorant faithfulness correctly predicts languages in which voicing of an obstruent cluster is determined by the rightmost obstruent. The only remaining issue is the position before a pause. In Hungarian, prepausal obstruent clusters exhibit the same properties as all other clusters: it is the rightmost obstruent that determines voicing. This is demonstrated by the data in (297).

(297) Prepausal obstruents do not devoice (Kata Tamási, Éva Dékány, p.c.)

|          |           |         |               |       |        |
|----------|-----------|---------|---------------|-------|--------|
| ɒz-ok    | ‘that-PL’ | ɒs-t    | ‘that-ACC’    | ɒz    | ‘that’ |
| lɛmɛz-ek | ‘disc-PL’ | lɛmɛs-t | ‘disc-ACC’    | lɛmɛz | ‘disc’ |
| kɒp-nɒk  | ‘get-3PL’ | kɒb-d   | ‘get-IMP.2SG’ | kɒp   | ‘get’  |
| a:ʃ-nɒk  | ‘dig-3PL’ | a:ʒ-d   | ‘dig-IMP.2SG’ | a:ʃ   | ‘dig’  |

Presonorant faithfulness cannot capture these patterns. Tableau (298) shows that the high ranked MAXLINK-PRESON[voice] never applies in the prepausal position. Since voicing is not preserved by the positional faithfulness constraint, the

alignment constraints prefer delinking (c) rather than spreading (b). This is because spreading to all segments is usually not possible, so delinking is the only way to satisfy this constraint. The problem is that candidate (b) with spreading is actually attested.

(298) /kɒpd/ → \*[kɒpt] ‘get.IMP.2SG’

|            | MAXLINK-PRESON[voi] | *IP([voi], ×) | *IP(×, [voi]) | MAXLINK[voi] | DEPLINK[voi] |
|------------|---------------------|---------------|---------------|--------------|--------------|
| /kɒp - d/  |                     |               |               |              |              |
| a. kɒp d   |                     |               | *!*           |              |              |
| b. ☹ kɒb d |                     |               | *!*           |              | *            |
| c. ☺ kɒpt  |                     |               |               | *            |              |

The ranking in (298) produces a grammar with voicing assimilation in most positions, but final devoicing in the phrase final position. Such patterns are indeed attested in many languages (e.g. Polish, Russian). These languages then present a simple case that requires a single positional faithfulness constraint. The challenge is that Hungarian does not show final devoicing.

In response to this fact, Blaho (2002, 2008), Petrova & Szentgyörgyi (2004), Petrova et al. (2006), propose another positional faithfulness constraint, and this one is specific to the final segment. In the present context, this final segment is within an Intonational Phrase. The constraint MAXLINK-FINAL[voice] is defined in (299).

(299) MAXLINK-FINAL[voice]

Let  $x_i \mathfrak{R} x_o$ .

Assign a violation mark, iff

(i)  $\nexists x$ , such that  $x_o < x$ , within an IP  
and

(ii)  $x_i$  is fully associated with the feature [f] and  $x_o$  is not.

IP-final faithfulness is part of a larger class of domain-final faithfulness constraints, which are themselves part of rightmost faithfulness constraints. The idea behind this approach is that the right edge is more prominent than other positions. The remaining issue is whether we need positional faithfulness to both edges.

One option would be to say no. That is, there is only rightmost, but no leftmost, positional faithfulness. This can be grounded typologically, acoustically, and psycholinguistically. As observed in the literature, the two edges behave differently. For example, many languages require morphological constituents (such as roots) and prosodic constituents (such as words) to end on a consonant. Furthermore, there are languages in which vowel or consonant harmony are triggered by the rightmost segment of a particular kind, and are thus regressive. However, there is no language with purely progressive vowel or consonant harmony. The acoustic grounding comes from the fact that many languages show phrase-final lengthening (Lehiste 1972; Oller 1973; Ladd & Campbell 1991; Wightman et al. 1992), which suggests that those positions are likely to allow more contrast. The cognitive advantage of the segments at the right edge of a domain is in recency effects (see Glenberg & Swanson 1986 for a review). From the perspective of a listener, right edges of domains are more recent than other positions. Recent information is easier to recall, hence rightmost positions allow for more contrast than other positions.

The other option would be to unify both rightmost and leftmost positional faithfulness into a single concept. That is, both edges of domains are more prominent than other positions. One argument for this would be that alignment constraints are sensitive to both edges. Furthermore, the concept of leftmost faithfulness is well-established in the literature. Faithfulness to initial syllables has been proposed by Beckman (1997). Unifying domain-initial and domain-final positions makes sense even in terms of psycholinguistic evidence. Ebbinghaus (1913) was the first to show that when subjects are asked to recall words from a list, their performance is dependent on the position of the word on the list. Initial and final words are recalled with highest accuracy.

I remain agnostic as to which of the two options is better. In what follows, I will discuss positional faithfulness to the final position. In Hungarian, the constraint MAXLINK-FINAL[voice] (299) outranks alignment and faithfulness constraints. This ranking preserves association lines to [voice] in the word-final obstruent, as shown in (300). Candidate (a) has no spreading and violates alignment once more than candidate (b) that has spreading. Candidate (c) with devoicing violates the high ranked positional constraint MAXLINK-FINAL[voice].

(300) kɒbd ‘get.IMP.2SG’

|    |               | MAXLINK-FINAL[voi] | *IP([voice], ×) | *IP(×, [voice]) | MAXLINK[voice] | DEPLINK[voice] |
|----|---------------|--------------------|-----------------|-----------------|----------------|----------------|
|    | / k ɒ p - d / |                    |                 |                 |                |                |
| a. | k ɒ p d       |                    |                 | ***!            |                |                |
| b. | k ɒ b d       |                    |                 | **              |                | *              |
| c. | k ɒ p t       | *!                 |                 |                 | *              |                |

The same ranking prefers devoicing when the final obstruent cluster ends on a voiceless obstruent, as shown in (301). This is because voicing of the penultimate obstruent is not protected by the positional faithfulness constraint. The delinked candidate (c) vacuously satisfies the alignment constraints, whereas both the faithful candidate (a) and candidate (b) with spreading violate at least one of the two alignment constraints.

(301) ɒst ‘that.ACC’

|    |           | MAXLINK-FINAL[voi] | *IP([voice], ×) | *IP(×, [voice]) | MAXLINK[voice] | DEPLINK[voice] |
|----|-----------|--------------------|-----------------|-----------------|----------------|----------------|
|    | / ɒ z t / |                    |                 |                 |                |                |
| a. | ɒ z t     |                    | *(!)            | *(!)            |                |                |
| b. | ɒ z d     |                    |                 | *!              |                | *              |
| c. | ɒ s t     |                    |                 |                 | *              |                |



We have now seen that the Hungarian data necessitates two positional faithfulness constraints. The first one is specific to the presonorant position, while the second one refers to the IP-final position.

The contribution of this section can be summarized as follows. First, I have demonstrated that positional faithfulness constraints work together with alignment constraints. Since the main advantage of the current approach is that it uses a single class of markedness constraints to drive all kinds of assimilation, it was important to show it can deal with local consonant assimilation. Second, positional MAXLINK[f] is sufficient to achieve this task. That is, the positional faithfulness constraint is violated only by delinking, but not by linking. Third, presonorant and final positions are very different concepts. In languages like Hungarian, we see the effects of both. In other languages we can see only one. For example, voicing assimilation is found in languages with final devoicing, such as Polish or Russian. In these, only presonorant faithfulness is ranked above alignment.

The final option are languages in which only final, but not presonorant, faithfulness is ranked above alignment. These will be reviewed in the following section. In particular, I extend final faithfulness to consonant harmony. In these cases, the faithful consonant is not necessarily strictly final, but can occur even several syllables away from the edge. What appears to be relevant is that the faithful consonant is the rightmost segment of a particular kind within a domain.

## 9.4 Rightmost faithfulness

So far we have seen final faithfulness that referred to the absolute edge of a domain. In this section, I extend the notion of right edge faithfulness to include not only the final, but also the rightmost segment of a particular kind within a domain. This pattern is found in Chumash consonant harmony (section 9.4.1), Turkana vowel harmony (section 9.4.2), and Tashlhiyt Berber labial dissimilation (section 9.4.3).

### 9.4.1 Chumash

Recall retroflex harmony in Kalasha which was analyzed in section 8.5.3. Kalasha retroflexion applies within coronal fricatives, affricates and stops, but not across these groups. The analysis did not address inputs with two retroflex coronals from different groups. Richness of the Base requires that these inputs map to some outputs, and given the attested patterns we would expect dissimilation. For example, an input with one retroflex fricative and one retroflex stop should map to an output in which one of the two coronals is not retroflex. In other words, Kalasha retroflexion involves spreading in some cases but delinking in others, which

suggests that the pattern can be characterized as assimilation, although in slightly different terms than the cases reviewed in this chapter so far. Kalasha exhibits faithfulness to some position within a root. That is, one of the two coronals always surfaces faithfully. However, other than diachronic information we have no synchronic evidence for which of the two coronals is faithful and which loses retroflexion. In light of this fact, I instead propose an analysis of another pattern where this kind of evidence is available.

Inseño Chumash (henceforth, Chumash) exhibits sibilant harmony similar to the kind in Aari, Koyra and Slovenian (section 8.5.2). Much like in the other three languages, Chumash (Applegate 1972; Beeler 1970; Harrington 1974; Poser 1982, 1993, 2004; Lieber 1987; Gafos 1996; Hansson 2001; McCarthy 2007a) coronal fricatives and affricates alternate in terms of anteriority. Posterior sibilants co-occur with posterior sibilants, whereas anterior sibilants co-occur with anterior sibilants. However, unlike in the previously analyzed languages, the alternations in Chumash can be characterized as assimilation. This is because the final sibilant determines whether all other sibilants within a word are posterior or anterior. Aari, Koyra and Slovenian exhibit a different pattern, in which posteriority spreads, but anteriority does not.

The data in (302) reveal that Chumash anterior sibilants {s, ts} alternate with posterior sibilants {ʃ, tʃ}. The rightmost sibilant determines all preceding sibilants. When the rightmost sibilant is anterior, all other sibilants are also anterior. When the rightmost sibilant is posterior, all other sibilants are also posterior. Observe that the triggering sibilant needs not to be absolutely final, but can be even a syllable away from the right edge of the word, as long as no other sibilant follows (e.g. [kʃuʃojin] ‘I darken it’). Triggering sibilants in (302) are bolded, whereas targets are underlined.<sup>6</sup>

(302) Chumash sibilant harmony determined by the rightmost sibilant (Applegate 1972; Poser 1993:316)<sup>7</sup>

|                                             |                         |                                                         |                              |
|---------------------------------------------|-------------------------|---------------------------------------------------------|------------------------------|
| <u>s</u> <sup>h</sup> in’aj                 | ‘he puts it away’       | <u>ʃ</u> -uʃ’eʔe                                        | ‘he digs’                    |
| ka- <u>s</u> un-an                          | ‘I command’             | ka-ʔala- <u>ʃ</u> un-aʃ                                 | ‘he’s the boss’              |
| ha- <u>s</u> -xintila                       | ‘his gentile’           | ha- <u>ʃ</u> -xintila-waʃ                               | ‘his former gentile’         |
| <u>ʃ</u> i- <u>ʃ</u> kij                    | ‘aches’                 | <u>si</u> - <u>s</u> kij-us                             | ‘he has an ache’             |
| ki <u>ʃ</u> -kin                            | ‘I save it’             | ki <u>s</u> -kin-us                                     | ‘I save it for him’          |
| p-i <u>ʃ</u> -al-nanʔ                       | ‘don’t you two go’      | s-is <sup>h</sup> -uleqpej-us                           | ‘they two want to follow it’ |
| <u>s</u> -api-t <u>s</u> <sup>h</sup> ol-us | ‘he has a stroke of gl’ | <u>ʃ</u> -api-t <u>ʃ</u> <sup>h</sup> o-u <u>ʃ</u> -waʃ | ‘he had a stroke of gl’      |
| k- <u>ʃ</u> u- <u>ʃ</u> ojin                | ‘I darken it’           | <u>ʃ</u> -api-t <u>ʃ</u> <sup>h</sup> ol-it             | ‘I have a stroke of gl’      |

<sup>6</sup>An important wrinkle in the data is that non-sibilant coronals trigger dissimilation of heteromorphemic sibilants, as long as they are strictly adjacent (see references above for details). A full analysis of this pattern would require a significant deviation, which is not crucial for the present discussion which focuses on positional faithfulness effects.

<sup>7</sup>gl – good luck

To recap, the rightmost sibilant in a word determines anteriority of all preceding sibilants in Chumash. Put differently, the faithful segment is the sibilant closest to the right edge of a word. The proximity to the right edge of a word makes Chumash sibilant alternations similar to Hungarian voicing assimilation. Recall that the Hungarian data give evidence for a positional faithfulness constraint specific to the absolutely final position. However, the absolutely final position is just another way of saying that there are no following obstruents within a domain. This reveals that Hungarian is quite similar to Chumash in that the rightmost segment of a particular kind within a domain is protected by a positional faithfulness constraint. In Hungarian, reference to another feature—such as [obstruent]—is not obligatory. That is, a root node in a precedence relation with another root node is enough to define the IP-final position, as seen in the constraint definition in (299). Chumash differs in two respects. First, it requires an explicit reference to sibilants, since the relevant segment is not necessarily absolutely final within a domain. In Chumash, the rightmost sibilant within a word always keeps its specification of the feature [posterior]. Second, the formal relation between [sibilant] and the relevant root node is f-precedence—just as we have seen for MAXLINK-PRESONORANT[voice] (294). The constraint active in Chumash thus refers to at least two features: [sibilant] and [posterior]. The positional faithfulness constraint MAXLINK-R([posterior], sibilant) is defined in (303). The feature [sibilant] serves here as a shorthand notation for the combination of features common to sibilants to the exclusion of all other segments. Note that the two features have a different status in the constraint definition and its shorthand notation.

- (303) MAXLINK-RIGHTMOST([posterior], sibilant)  
 Let  $\times_i \mathfrak{R} \times_o$ .  
 Assign a violation mark, iff
- (i)  $\nexists$  [sibilant], such that  $\times_o \triangleleft$  [sibilant], within a PWd  
 and
  - (ii)  $\times_i$  is fully associated with [posterior] and  $\times_o$  is not.

The ranking in Chumash is analog to the ranking in Hungarian voicing assimilation on the one hand and the ranking in Aari, Koyra, and Slovenian sibilant harmony on the other. Recall that sibilant harmony requires agreement constraints, ranked above alignment, which in turn outranks the faithfulness constraints. I will take the ranking established for Aari, Koyra and Slovenian, with the positional faithfulness constraint MAXLINK-RIGHTMOST([posterior], sibilant) ranked highest. I also assume bidirectional harmony, which requires two alignment constraints, much like in cases of voicing simulation. The effect of all these constraints is evident in tableaux (304)–(306).

In (304), we first see an input containing only two coronals that are also sibilants. When the feature [posterior] is associated with the rightmost one, we expect spreading to the preceding sibilant, as in candidate (c). The ranking of the four highest constraints is directly parallel to the ranking found in Hungarian (296), except that different features and domains are involved. This ranking rules out the faithful candidate (a) and the candidate with delinking (b). The positional faithfulness constraint  $\text{MAXLINK-RIGHTMOST}([\text{posterior}], \text{sibilant})$  is violated by a delinked sibilant, if it is also the rightmost sibilant within a word. Only candidate (b) violates this constraint. The remaining two candidates—(c) and (d)—do not violate any of the three highest ranked constraints. The winner is decided by  $\text{DEPLINK}[\text{posterior}]$ , which is ranked next. As a side note, recall Hungarian where the ranking of  $\text{MAXLINK}[\text{voice}]$  and  $\text{DEPLINK}[\text{voice}]$  was not crucial—see for example (300) and (301). The reason for this is because spreading in Hungarian could never satisfy alignment constraints. More specifically, words (and hence IPs) in Hungarian have at least one vowel. Consequently, at least one of the alignment constraints referring to the feature [voice] will always be violated, and this ruled out all competing candidates. The ranking between  $\text{MAXLINK}[\text{voice}]$  and  $\text{DEPLINK}[\text{voice}]$  did not matter. The situation in Chumash is markedly different in that the two high ranked alignment constraints  $*\omega(\text{cor}, [\text{post}])$  and  $*\omega([\text{post}], \text{cor})$  can be satisfied by spreading. Consequently,  $\text{DEPLINK}[\text{posterior}]$  must outrank  $\text{MAXLINK}[\text{posterior}]$ , and not vice versa. The alignment constraints with a root node as the targeted structure also need to be ranked below  $\text{DEPLINK}[\text{posterior}]$ . Similar rankings of multiple alignment constraints with respect to faithfulness have been previously discussed in section 3.

(304) ʃuʃ'eʔe 'he digs'

|                                                                                                                                            | MAXLINK-R([post],sib) | * $\omega$ (cor,[post]) | * $\omega$ ([post],cor) | DEPLINK[post] | * $\omega$ ( $\times$ ,[post]) | MAXLINK[post] |
|--------------------------------------------------------------------------------------------------------------------------------------------|-----------------------|-------------------------|-------------------------|---------------|--------------------------------|---------------|
| $\begin{array}{c} \text{[p]} \\ \text{[c]} \text{ - u } \text{[c]} \text{ e } \text{?} \text{ e} \end{array}$                              |                       |                         |                         |               |                                |               |
| a. $\begin{array}{c} \text{[p]} \\ \text{[c]} \text{ u } \text{[c]} \text{ e } \text{?} \text{ e} \end{array}$                             |                       | *!                      |                         |               | **                             |               |
| b. $\begin{array}{c} \text{[p]} \\ \text{[c]} \text{ u } \text{[c]} \text{ e } \text{?} \text{ e} \end{array}$                             | *!                    |                         |                         |               |                                | *             |
| c. $\begin{array}{c} \text{[P]} \\ \text{[p]} \text{ u } \text{[p]} \\ \text{[c]} \text{ [c]} \text{ e } \text{?} \text{ e} \end{array}$   |                       |                         |                         | *             | *                              |               |
| d. $\begin{array}{c} \text{[P]} \\ \text{[p]} \text{ [p]} \text{ [p]} \\ \text{[c]} \text{ [c]} \text{ e } \text{?} \text{ e} \end{array}$ |                       |                         |                         | **!           |                                |               |

Now that we have determined the ranking between DEPLINK[post] and MAXLINK[post], we can proceed to more complex examples. I want to show two things: (i) how other coronals are affected by alignment constraints, and (ii) what the effect of agreement constraints is. A complete analysis of sibilant harmony in Chumash requires agreement constraints, just as we have seen for Aari, Koyra, and Slovenian (section 8.5.2). In (305), we see an input with a posterior sibilant preceded by an anterior one. This time, other coronals also appear within the word. Candidate (a) shows no spreading and crucially violates the leftward alignment constraint. Candidate (b) has delinking, but this violates the high ranked positional faithfulness constraints. As we have seen in (304), MAXLINK-RIGHTMOST([posterior], sibilant) is violated by a delinked sibilant, but only if it is at the same time the rightmost sibilant within a word. This is the case only for candidate (b). Of the remaining candidates, (c) satisfies all agreement constraints and shows spread-

ing only to the preceding sibilant. Mind that the feature [stop] is common only to plosives and excludes affricates, hence spreading across the two groups does not violate AGREE([post],stop). Finally, candidate (d) has spreading to all coronals and violates no alignment constraints. However, progressive spreading to non-sibilant coronals creates fatal violations of agreement constraints. Keep in mind that the representation of the trigger in candidate (d) involves two Heads-of-Heads and two double p-nodes, although only one of each is shown. Recall that bidirectional spreading consists of leftward and rightward spreading. This way the maximally binary branching restriction is obeyed. See section 4.5.2 for further discussion regarding bidirectional spreading.



also fatally violates alignment, whereas candidate (e) satisfies it, but violates agreement. I should add that the representations in candidate (d) exhibit a double head and double p-nodes on the trigger, but these are represented by one symbol, just as we have seen in tableau (305). This maintains maximal binarity of branching.





The conclusion that can be drawn directly from the tableaux above is that Chumash sibilant harmony is bidirectional rather than regressive. Most analyses assume that the assimilation patterns seen so far are regressive. This is because a feature spreads from the rightmost segment. However, if assimilation were truly regressive, we would see spreading from any segment with the relevant feature. This is not what happens in Chumash, where delinking is actually found. Delinking is enforced by the progressive alignment constraint  $*\omega([\text{post}],\text{cor})$ . In the analysis of Chumash, this constraint is clearly required to exclude candidates with regressive spreading from non-final positions, such as candidate (306-c). In other words, bidirectionality of assimilation is obscured by positional faithfulness.

Apparent bidirectionality of Chumash strongly suggests that local consonant spreading—such as voicing assimilation—is also bidirectional. This becomes evident when we look at clusters of three or more obstruents, of which only the penultimate is underlyingly voiced. For example, a hypothetical input /apdka/ maps to [aptka] rather than \*[abdka] as it would be if spreading were only regressive. The only constraint that is violated by \*[abdka], but not by the actual winner [aptka] is the progressive alignment constraint  $*\omega([\text{voi}], \times)$ . While this hypothetical example demonstrates that both a progressive and a regressive alignment constraint are required, most languages do not offer perspicuous data of such alternations. What is required is a string of three heteromorphemic obstruents that disagree in voicing. Typically, languages exhibit epenthesis or deletion in such situations. In contrast, the Chumash data are unambiguous, because the sibilants need not to be strictly adjacent to one another. Any three sibilants that disagree in posteriority within a word are sufficient. The input in (306) is one such example, and reveals that posteriority never spreads leftwards, unless it spreads from the rightmost sibilant. This further reaffirms the characterization of assimilation in Chumash as spreading in some cases, but delinking in all others.

The current, less restricted version of final faithfulness predicts patterns in which the rightmost segment with some feature specification will decide spreading or delinking of all other targets within a domain. This is confirmed by languages with consonant harmony. In Chumash, anteriority/posteriority of coronals is determined by the rightmost sibilant, even if it is not absolutely word-final. Chumash is representative of a larger class of sibilant (and more broadly, consonant) harmony patterns. I have shown that relativizing positional faithfulness to a segment closest to the right edge allows for a unified analysis of local consonant spreading (as in Hungarian) and consonant harmony (as in Chumash). Furthermore, positional MAXLINK[f] is sufficient to achieve this task and no positional IDENT(f) is required. In the following section, I extend the notion of rightmost faithfulness to vowel harmony.

### 9.4.2 Turkana

In the previous sections, I have demonstrated that the cross-linguistic data in voicing assimilation and consonant harmony supply evidence for rightmost faithfulness. In this section, I extend the approach to vowel harmony in Turkana. In this language, the rightmost vowel determines the identity of all other vowels. This is independent of whether the final vowel is in the root or in the suffix.

Turkana has tongue root harmony which differs from any of the previously reported cases of vowel harmony (Dimmendaal 1983; Vago & Leder 1987; Noske 1990, 1996, 2000). In particular, the rightmost vowel affects all vowels within the word. The data in (307) show that when the rightmost vowel is tense, all preceding vowels are tense. Conversely, when the rightmost vowel is lax, all preceding vowels are lax. This is independent of the morphological affiliation of that vowel. In (307-a) root vowels trigger harmony in prefixes. In (307-b) suffix vowels trigger harmony in all preceding morphemes.

- (307) Turkana ATR harmony determined by the rightmost vowel (Noske 2000:777, 779,780)
- a. Root to prefix
- |                 |                               |                   |               |
|-----------------|-------------------------------|-------------------|---------------|
| <u>e</u> -kori  | ‘giraffe.SG’                  | <u>ɛ</u> -kɔri    | ‘rater.SG’    |
| <u>e</u> -risik | ‘anti-witchcraft<br>charm.SG’ | <u>ɛ</u> -lɔkɔtɔj | ‘wild cat.SG’ |
- b. Suffix to root
- |                   |             |                                       |                         |
|-------------------|-------------|---------------------------------------|-------------------------|
| a-k- <u>im</u> ɔj | ‘to eat’    | e-k- <u>im</u> ɔj- <u>e</u>           | ‘way of eating’         |
|                   |             | a-k- <u>im</u> ɔj- <u>e:n</u>         | ‘to eat regularly’      |
| a-kɪ- <u>d</u> ɔk | ‘to climb’  | e- <u>d</u> ɔk- <u>e</u>              | ‘way of climbing’       |
|                   |             | e- <u>d</u> ɔk- <u>e:n</u> - <u>e</u> | ‘s/he always climbs’    |
| a-kɪ- <u>l</u> ep | ‘to milk’   | a- <u>l</u> ɛp-ɔr                     | ‘to milk out’           |
| a-kɪ- <u>g</u> ɔl | ‘to close’  | a- <u>g</u> ɔl-ɔr                     | ‘to close out’          |
| a-kɪ- <u>b</u> ɔŋ | ‘to return’ | a- <u>b</u> ɔŋ-ɔr                     | ‘to return to a place’  |
| a-kɪ- <u>r</u> em | ‘to spear’  | ɛ- <u>r</u> ɛm- <u>ɛ</u> -rɛ          | ‘(why) is it speared?’  |
| a-kɪ- <u>m</u> ɔr | ‘to insult’ | ɛ- <u>m</u> ɔr- <u>ɛ</u> -rɛ          | ‘(why) is he insulted?’ |

Observe that the feature specification of a suffix vowel can be overruled by the effects of a vowel in the following suffix. For example, the distinction between [a-kɪ-dɔk] ‘to climb’ and [e-dɔk-e] ‘way of climbing’ suggests that the gerund suffix /-e/ is underlyingly tense. However, the form [a-rɛm-ɛ-rɛ] ‘(why) is it speared?’ demonstrates that the vowel in the subjunctive suffix /-rɛ/ is lax, which makes the preceding gerund suffix /-e/ lax, too. This generalization can be restated in terms of rightmost faithfulness. What matters in Turkana is the identity of the rightmost vowel. If the rightmost vowel is tense, all other vowels will be tense. If it is lax, all other vowels are lax.

Before proceeding to the analysis, I want to add two further observations. First, the low vowel [a] blocks harmony, as shown in (308). One option would be to say that the spreading feature in Turkana is [atr], and the low vowel acts as a blocker. An alternative would be to say that Turkana has spreading of [rtr], in which case the low vowel is a further trigger. To the best of my knowledge, Turkana does not offer data in which the predictions of [atr] spreading would differ from [rtr] spreading. I choose [atr] as the spreading feature, although [rtr] is an entirely possible alternative.

- (308) Low vowel [a] blocks harmony (Noske 2000:779)
- |                                      |                     |
|--------------------------------------|---------------------|
| <u>ε</u> - <u>ra</u> m- <u>e</u> n-e | ‘s/he always beats’ |
| <u>ε</u> - <u>ra</u> m- <u>e</u>     | ‘way of beating’    |
| <u>ε</u> - <u>ca</u> l- <u>e</u>     | ‘noise, screaming’  |

The second observation concerns a class of suffixes that undergo spreading from the root. These are not like the dominant suffixes in (307), which trigger assimilation themselves. The difference between the two classes of suffixes suggests that Turkana shows both effects of root faithfulness and rightmost faithfulness. However, rightmost faithfulness is specific to roots and certain suffixes, but not other suffixes. In other words, rightmost faithfulness is partially morphologically conditioned. There is a variety of ways to deal with this kind of exceptionality. One option is to assume that suffixes that undergo spreading from roots are underspecified for [atr]. Another option is to say that exceptional suffixes are indexed and that specific high ranked alignment constraints apply to them. For evidence that markedness constraints need to be lexically indexed, see Pater (2000, 2007, 2009); Gouskova (2007); Flack (2007); Jurgec (2010a). Indexed constraints are further discussed in section 4.3.2. Root faithfulness is further discussed in section 9.5.

We can now proceed to the analysis. Turkana is consistent with a typical assimilation pattern. Recall that assimilation involves an interaction of positional faithfulness ranked above alignment and faithfulness. I will analyze Turkana with [atr] as the active feature, but the data is entirely consistent with an [rtr]-based analysis (as discussed above). I limit the discussion to patterns within a word, so the alignment constraints target all vowels within that domain:  $*\omega([atr], vowel)$  and  $*\omega(vowel, [atr])$ . Low vowels block spreading, which is enforced by a high ranked feature co-occurrence constraint  $*[atr\ low]$ . The low ranked faithfulness constraints are  $DEPLINK[atr]$  and  $MAXLINK[atr]$ . Finally, the positional faithfulness constraint is  $MAXLINK-RIGHTMOST([atr], vowel)$ , as defined in (309). This constraint preserves the association line with [atr] on the rightmost vowel within a word, regardless of whether it is in the root or suffix.

(309) MAXLINK-RIGHTMOST([atr], vowel)

Let  $\times_i \mathfrak{R} \times_o$ .

Assign a violation mark, iff

- (i)  $\nexists$  [vowel], such that  $\times_o \triangleleft$  [vowel], within a PWD  
and
- (ii)  $\times_i$  is fully associated with [atr] and  $\times_o$  is not.

The effect of the ranking is shown in tableaux (310) and (311). Tableau (310) shows an input with [atr] linked to the rightmost vowel. The faithful candidate (a) fatally violates one of the alignment constraints. Candidate (b) with delinked [atr] violates the positional faithfulness constraint. Candidate (c) with spreading to all vowels wins. Candidate (d) has spreading to all segments, which incurs additional and fatal violations of DEPLINK[atr].

(310) edoke ‘way of climbing’

|                                                                                        | MAXLINK-R([atr],vow) | * $\omega$ (vowel, <sub>i</sub> [atr]) | * $\omega$ ( <sub>i</sub> [atr],vowel) | DEPLINK[atr] | * $\omega$ ( $\times_i$ [atr]) | MAXLINK[atr] |
|----------------------------------------------------------------------------------------|----------------------|----------------------------------------|----------------------------------------|--------------|--------------------------------|--------------|
| /ε - dɔk - e / <sup>[a]</sup>                                                          |                      |                                        |                                        |              |                                |              |
| a. ε dɔk e <sup>[a]</sup>                                                              |                      | *!*                                    |                                        |              |                                |              |
| b. ε dɔk ε                                                                             | *!                   |                                        |                                        |              |                                | *            |
| c.  |                      |                                        |                                        | **           | **                             |              |
| d.  |                      |                                        |                                        | ***!*        |                                |              |

Tableau (311) shows an input, in which [atr] is linked to two vowels, neither of which is the rightmost within the word. The faithful candidate (a) fatally violates the alignment constraints. The winning candidate (b) has delinking, and violates only a low ranked faithfulness constraint. Candidate (c) has spreading to the first vowel, which still violates alignment. Candidate (d) has delinking of one of the two instances of [atr], and regressive spreading. Since there is no progressive spreading, one of the two alignment constraints is still fatally violated. Finally, candidate (e) with bidirectional vowel harmony fatally violates DEPLINK[atr].

(311) εrɛmɛrɛ ‘(why) is it speared?’

|                                             | MAXLINK-R([atr],vow) | *ω(vowel,[atr]) | *ω([atr],vowel) | DEPLINK[atr] | MAXLINK[atr] |
|---------------------------------------------|----------------------|-----------------|-----------------|--------------|--------------|
| <div style="text-align: center;"> </div>    |                      |                 |                 |              |              |
| a. <div style="text-align: center;"> </div> |                      | *(!)**          | *(!)**          |              |              |
| b.  ε r ε m ε r ε                           |                      |                 |                 |              | **           |
| c. <div style="text-align: center;"> </div> |                      | *(!)*           | *(!)**          | *            |              |
| d. <div style="text-align: center;"> </div> |                      |                 | *!              | **           | *            |
| e. <div style="text-align: center;"> </div> |                      |                 |                 | *!***        | *            |

I have now extended the notion of rightmost faithfulness to vowel harmony. This is significant because it is well-established that vowel harmony shows the effects of leftmost faithfulness, too. Beckman (1997, 1998) shows that vowel harmony in

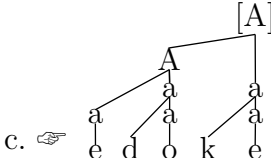
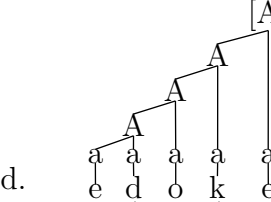
Shona requires positional faithfulness to root-initial syllables. This is because mid vowels are possible only in that position in Shona. However, positional faithfulness to initial syllables can be restated as a positional faithfulness to the leftmost vowel. In this sense it is possible to unify both directional variants—leftmost and rightmost faithfulness—as an instantiation of a single concept of edgemost faithfulness (see section 9.3 for further discussion).

Faithfulness to the initial syllable is not limited to vowel harmony, but can be extended to other assimilation patterns. For instance, Applecross Gaelic has nasal harmony with root-initial positional faithfulness (Walker 1998/2000, for details see section 2.2.2 here). Furthermore, Beckman (1997, 1998) provides numerous examples of consonants limited to the initial syllable. For example, Tamil codas need to share place of articulation with the following onset, but initial syllables are exempt from such restrictions. Again, what this shows is positional faithfulness to the leftmost syllable or segment.

The only remaining gap seems to be that no consonant harmony case necessitates positional faithfulness to the leftmost consonant (Hansson 2001). This is because the leftmost consonant is usually in the root, and only suffixes show alternations. Consequently, the data can be accounted for by using root faithfulness (section 9.5). Furthermore, spreading from prefixes is many times obscured by positional faithfulness to roots, which in turn block spreading from prefixes. Another factor is that prefixes are cross-linguistically significantly rarer than suffixes (Sapir 1921:67; Greenberg 1966:92; Bybee et al. 1990:4), and that consonant harmony is also rare. This suggests that it would be hard to find languages with consonant harmony, prefixes, and positional faithfulness to the leftmost position. In the lack of definite evidence of spreading from prefixes, I side with Hansson (2001) and remain agnostic about positional faithfulness to leftmost consonants.<sup>8</sup>

### 9.4.3 Tashlhiyt Berber

So far we have seen the effects of rightmost faithfulness in two different assimilation processes: Chumash sibilant harmony and Turkana vowel harmony. Rightmost faithfulness can be easily extended to patterns other than assimilation. A simple example would be a language that allows a particular contrast only at the rightmost position (relativized to a particular type of segment). For example, Slovenian allows [ʌ] only as the stressed word-final vowel (e.g. [motʃe'ɾʌt] 'salamander.NOM.SG' ~ [motʃe'ɾʌda], \*[motʃe'ɾʌda] 'GEN.SG', cf. [ka'ɾat] 'carat'). Another kind of process that requires positional faithfulness is dissimilation. In this section,

---

<sup>8</sup>Support for leftmost faithfulness may come from static co-occurrence restrictions. An example comes from Aymara (Mackenzie 2009). This language allows ejectives and aspirated stops, but only if they are not preceded by any other stop. The ejectives and aspirates can occur in any syllable of the word.

I continue the analysis of Tashlhiyt Berber labial dissimilation from section 3.3.2. I show that the difference between assimilation and dissimilation falls from the ranking of alignment, positional and general faithfulness constraints.

Recall that Tashlhiyt Berber (henceforth, Tashlhiyt) has a dissimilatory pattern in which no more than one labial consonant is possible per word. This is demonstrated by the data in (63)—repeated in (312) for convenience. A prefix containing a labial nasal surfaces as coronal when followed by labial (or labiodental) consonant within the root.<sup>9</sup>

(312) Tashlhiyt labial dissimilation (El Medlaoui 1995:46–47; Odden 1994:319; Alderete 1997:27)

|                  |                 |                  |                         |
|------------------|-----------------|------------------|-------------------------|
| <u>m</u> -xazar  | ‘scowl.REFL’    | <u>n</u> -fara   | ‘disintangle.REFL’      |
| <u>m</u> -saggal | ‘look for.RELF’ | <u>n</u> -ħaʃʃam | ‘be shy.RELF’           |
| <u>mm</u> -ʒla   | ‘lose.REFL’     | <u>n</u> -kaddab | ‘consider a liar.REFL’  |
| <u>am</u> -las   | ‘shear.AGENT’   | <u>an</u> -bur   | ‘remain celibate.AGENT’ |
| <u>am</u> -krz   | ‘plow.AGENT’    | <u>an</u> -AZUM  | ‘fast.AGENT’            |

In chapter 3 we have already seen that alignment constraints are a powerful tool that can deal with mean different patterns. This includes assimilation and dissimilation. The idea was that the difference between assimilation and dissimilation is due to the ranking of alignment constraints with respect to faithfulness constraints. In tableau (65), I showed the effect for general faithfulness constraints. The point was that alignment has to outrank MAXLINK[f]. However, at that time I did not yet introduce positional faithfulness. Here, I continue the analysis making use of MAXLINK-RIGHTMOST[f].

In Tashlhiyt, the generalization seems to be rightmost labial within a word surfaces faithfully, and all other labials dissimilate. The rightmost labial can be in any morpheme of the word. The positional faithfulness required in an analysis of Tashlhiyt needs to refer to the rightmost labial, as shown in (313). What MAXLINK-RIGHTMOST([labial],labial) does is preserve association line with [labial] only on the rightmost segment within a word, whose input correspondent is also associated with [labial].

(313) MAXLINK-RIGHTMOST([labial],labial)

Let  $\times_{ai} \mathfrak{R} \times_{ao}$  and  $\times_{bi} \mathfrak{R} \times_{bo}$ .

Assign a violation mark for every  $\times_{ao}$ , iff

(i)  $\nexists \times_{bo}$ , such that  $\times_{ao} < \times_{bo}$  and  $\times_{bi}$  is fully associated with [labial],  
and

(ii)  $\times_{ai}$  is fully associated with [labial] and  $\times_{ao}$  is not.

<sup>9</sup>Capitals mark emphatic consonants.



The constraint in (313) differs in one crucial difference from previously proposed positional faithfulness constraints. The positional constraints used in Chumash and Turkana were of the type  $\text{MAXLINK-R}([f], g)$  and referred to two *different* features: association line with  $[f]$  is preserved on segments associated with  $[g]$ . The constraint in (313) is of the type  $\text{MAXLINK-R}([f], f)$ , and refers to two instances of a single feature. This needs to be so because of the assumptions we are making about features. That is, looking at the output alone, there is no way to distinguish consonants that lost  $[\text{labial}]$  from those that did not have it underlyingly. A related issue is that the reference to the input in (313-i). Positional faithfulness constraints standardly refer to the position in the output. Here, I am using privative features in combination with  $\text{MAXLINK}[f]$  rather than  $\text{IDENT}(f)$ . As a consequence, it is impossible to directly tease apart underlying non-labial consonants from the derived ones. I propose that this can be remedied by referring to both the input and output. That is, the relevant position can only be defined by looking at the all segments that have  $[\text{labial}]$  underlyingly. Of these, the positional faithfulness constraint refers to the one whose output correspondent is the rightmost within a word.

The effect of  $\text{MAXLINK-RIGHTMOST}([\text{labial}], \text{labial})$  is shown in (314) and (315). First, let us consider an input with two labials. The expected winner is candidate (d) with a delinked left labial. Candidates (b–c) with delinked rightmost labial violate the positional faithfulness constraint. The candidates with spreading (e–f) need to be ruled out, which means that  $\text{DEPLINK}[\text{labial}]$  must outrank the alignment constraint. The faithful candidate (a) loses on alignment.

(314) anRMI 'be tired.AGENT'

|    |                                                                                                                     | MAXLINK-R([lab],lab) | DEPLINK[lab] | * $\omega(\times, [lab])$ | MAXLINK[lab] |
|----|---------------------------------------------------------------------------------------------------------------------|----------------------|--------------|---------------------------|--------------|
|    | $\begin{array}{c} [lab]_1 \quad [lab]_2 \\   \quad   \\ / a \ m \ - \ R \ M \ I / \end{array}$                      |                      |              |                           |              |
| a. | $\begin{array}{c} [lab]_1 \quad [lab]_2 \\   \quad   \\ a \ m \ R \ M \ I \end{array}$                              |                      |              | ****!                     |              |
| b. | a n R N I                                                                                                           | *!                   |              |                           | **           |
| c. | $\begin{array}{c} [lab]_1 \\   \\ a \ m \ R \ N \ I \end{array}$                                                    | *!                   |              | ***                       | *            |
| d. | $\begin{array}{c} [lab]_2 \\   \\ a \ n \ R \ M \ I \end{array}$                                                    |                      |              | *                         | *            |
| e. | $\begin{array}{c} [LAB]_{1,2} \\ / \quad \backslash \\ lab \quad lab \\   \quad   \\ a \ m \ R \ M \ I \end{array}$ |                      | *!*          | **                        |              |
| f. | $\begin{array}{c} [LAB]_2 \\ / \quad \backslash \\ lab \quad lab \\   \quad   \\ a \ m \ R \ M \ I \end{array}$     |                      | *!           | **                        | *            |

The high ranked positional faithfulness preserves an association line to the right-most labial, irrespective of its morphological affiliation within a word. In (315) we see an input with a labial in the prefix. Since there are no other labials within a word, MAXLINK-R([labial], labial) refers to this segment. Delinking, as in candidate (b), violates the positional faithfulness constraints, whereas spreading violates DEPLINK[labial]. The faithful candidate (a) wins, despite its violation of the alignment constraint.

(315) amlas ‘shear.AGENT’

|                                                                                                                                                   |                      |              |                                  |              |
|---------------------------------------------------------------------------------------------------------------------------------------------------|----------------------|--------------|----------------------------------|--------------|
| $\begin{array}{c} [\text{lab}] \\   \\ / \text{ a m } - \text{ l a s } / \end{array}$                                                             | MAXLINK-R([lab],lab) | DEPLINK[lab] | * $\omega(\times, [\text{lab}])$ | MAXLINK[lab] |
| a. $\rightarrow$ $\begin{array}{c} [\text{lab}] \\   \\ \text{ a m l a s } \end{array}$                                                           |                      |              | *!                               |              |
| b. $\text{ a n l a s }$                                                                                                                           | *!                   |              |                                  | *            |
| c. $\begin{array}{c} [\text{LAB}] \\ / \quad \backslash \\ \text{lab} \quad \text{lab} \\   \quad   \\ \text{u} \quad \text{m l a s} \end{array}$ |                      | *!           |                                  |              |

We have now seen that positional effects in assimilation and dissimilation can be captured using a high ranked positional MAXLINK[f] in combination with alignment and general faithfulness. The crucial difference is in the ranking of the alignment constraints and DEPLINK. When alignment outranks DEPLINK[f], assimilation is preferred. When the ranking is reverse, we get dissimilation. The additional factor concerns the relationship between dissimilation and two kinds of assimilation. In particular, only some kinds of assimilation show positional effects (which are subject of this chapter), whereas all kinds of dissimilation do.

## 9.5 Root faithfulness

So far we have seen positional faithfulness effects specific to the presonorant and rightmost consonants or vowels. In this section, I look at another type of positional faithfulness constraints, which refer to morphological domains, and roots in particular. I first summarize the cross-linguistic generalizations (section 9.5.1). Then I revisit Twi to show the effect of root faithfulness (section 9.5.2).

### 9.5.1 Cross-linguistic generalizations

If we compare morphological constituents, roots are more prominent than affixes. This is a well established generalization that is supported by abundant cross-linguistic evidence (McCarthy & Prince 1993b, 1995; Beckman 1998; Baković 2000;

Urbanczyk 2006; Hyman 2008, among many others). Root prominence manifests itself in many different forms. For example, some languages allow certain segments in roots, but not in affixes. In Arabic (McCarthy & Prince 1995), for example, pharyngeals occur in roots, but not in affixes. Another manifestation of root prominence is directly relevant to assimilation. In some languages, features can spread from roots, but not the reverse. This is particularly striking in vowel harmony.

Phonological literature on vowel harmony distinguishes two major types of vowel harmony: root-controlled (or stem-controlled) and dominant–recessive. In root-controlled languages, a feature spreads from the root to affixes. If the root does not have a particular spreading feature, than all affixes also surface without it. Stated differently, the root determines the specification of all other morphemes, which is a positional effect. On the other hand, in dominant–recessive languages any morpheme can have a feature which can spread from a root to affixes, but also from an affix to a root and other affixes.

To illustrate the distinction between the two types of vowel harmony, I provide data from two languages with tongue root harmony in (316). The best evidence comes from languages that allow both prefixes and suffixes. Recall Twi from section 3.2.2. Twi exhibits root-controlled vowel harmony. Each root has either tense or lax vowels. The affixes alternate depending on what root they attach to, as in (316-a). What is not attested in Twi is that an affix vowel affects the tongue root value of a root vowel. Twi vowel harmony will be further analyzed in section 9.5.2.

(316) Two types of vowel harmony

- a. Root-controlled tongue root harmony in Twi (Berry 1957:127–128, 130)

|                |                                     |                                     |
|----------------|-------------------------------------|-------------------------------------|
|                | ‘fail, miss’                        | ‘lend, borrow’                      |
| ROOT           | $\sqrt{\text{firɪ}}$                | $\sqrt{\text{firi}}$                |
| 1P-FUT-ROOT-it | $\text{mɪ-bɛ-}\sqrt{\text{firɪ-ɪ}}$ | $\text{mɪ-be-}\sqrt{\text{firi-ɪ}}$ |

- b. Dominant-recessive tongue root harmony in Kalenjin (Baković 2000: 52)

|            |                                                                                                                                    |                     |
|------------|------------------------------------------------------------------------------------------------------------------------------------|---------------------|
| NO ATR     | $\text{kɪ-}\underline{\text{a}}\text{-}\sqrt{\text{gɛr}}$                                                                          | ‘I shut it’         |
| ATR ROOT   | $\text{k}\underline{\text{i}}\text{-}\underline{\text{ɛ}}\text{-}\sqrt{\text{kɛr-}\underline{\text{i}}\text{n}}$                   | ‘brand new’         |
| ATR SUFFIX | $\text{k}\underline{\text{i}}\text{-}\underline{\text{ɛ}}\text{-}\sqrt{\text{k}\underline{\text{e}}\text{r-}\underline{\text{e}}}$ | ‘I was shutting it’ |

The second type of harmony, dominant–recessive, is found in Kalenjin (Tucker 1964; Hall et al. 1974; Clements 1976/1980; Halle & Vergnaud 1981; Lieber 1987; Ringen 1988b; Archangeli & Pulleyblank 1994; Lodge 1995; Local & Lodge 1996; Baković 2000; Krämer 2003). Kalenjin has bidirectional tongue root harmony, which is triggered by any tense vowel, regardless of its morphological affiliation.

This means that a tense vowel in a root affects prefixes and suffixes, whereas a tense vowel in an affix affects all other affixes and a root, as long as they are within the domain of assimilation.

The distinction between the two types of vowel harmony can be extended to other cases of assimilation. Nasal harmony can serve as the first example. In some languages, nasality spreads only from roots to affixes. Examples include Mosestén (Sakel 2004) and Tuyuca (Barnes 1996; Walker 1998/2000). In other languages, including Sundanese or Johore Malay (section 6.6.1), nasality spreads without these restrictions. Consonant harmony exhibits a similar disparity. For example, Koyra has root controlled sibilant harmony, whereas Slovenian has dominant–recessive harmony (section 8.5.2). That is, [posterior] spreads only from roots to suffixes in Koyra (but not the reverse), whereas it spreads without such restrictions in Slovenian. Local consonant spreading shows the same behavior. Perhaps the most famous example of root-controlled alternations of obstruents is English, where a final root obstruent determines the suffix one (cf. *do*[g-z] vs. *ca*[t-s]). Voicing assimilation in Hungarian (section 9.2), on the other hand, is unaffected by word-internal morpheme boundaries. We can conclude that the distinction between root-controlled and dominant–recessive systems is not specific to vowel harmony, but it also found with other features.

In the current context, root-controlled patterns involve positional effects, which can be analyzed in terms of positional faithfulness (McCarthy & Prince 1995; Beckman 1998; Urbanczyk 2006), whereby roots are phonologically more prominent than suffixes. If so, there are positional faithfulness constraints to roots, but no positional faithfulness constraints to affixes. Positional faithfulness constraints to roots will be introduced in the following section.

Before I move on to root faithfulness and show its predictions, I will address a related issue, directionality. We have already seen that positional effects usually involve a bidirectional pattern. Both Twi and Kalenjin tongue root harmonies in (316) are also bidirectional. The question is whether all vowel harmony systems are in fact bidirectional, as proposed by Baković (2000). The challenge is that directionality in vowel harmony is hard to pinpoint. In some languages, directionality is intertwined with root control. If these languages have only one type of affixes, the pattern appears unidirectional: regressive if the language has only prefixes (as in Yoruba in section 6.4.2) and progressive if the language has only suffixes (as in Turkish in section 8.4.3). Yet directionality in these cases is only an illusion and has to do with lacking prefixes or suffixes.

Another obscuring factor is terminological. Vowel harmony is by definition a bidirectional pattern. Other processes involving vowel alternations, such as umlaut and metaphony, are typically not. The challenge is how to clearly distinguish vowel harmony from other patterns involving vowels. The standard claims

are: (i) umlaut involves a single target (as in Germanic, Slavic or Chamorro), whereas rounding harmony involves multiple targets; (ii) umlaut and metaphony are typically prosodically driven, whereas vowel harmony is not; (iii) umlaut and metaphony are unidirectional, whereas vowel harmony typically is not; (iv) umlaut and metaphony cannot skip segments, whereas vowel harmony can (Klein 1995/2000:1,145; Baković 2000; Krämer 2003:39ff.; Kaplan 2008b:183ff.). Icelandic u-umlaut (section 4.3) fails to qualify on the first and the second criterion. As regards the fourth criterion, Ascrea Italian displays metaphony which is triggered by a suffix and targets the stressed vowel, while skipping intermediate vowels (Fanti 1938, 1939, 1940; Maiden 1991; Walker 2009). Thus, the only remaining distinguishing variable is directionality. One could then say that umlaut, metaphony and vowel harmony are all cases of assimilation involving vowels, but they differ in terms of directionality. Umlaut and metaphony are unidirectional, whereas vowel harmony is bidirectional. If so, bidirectionality is a definitional property of vowel harmony and requires no additional account.

The claim that vowel harmony is bidirectional by definition runs counter to some reported cases of regressive vowel harmony. In these languages, a feature spreads from a suffix to the preceding morphemes (suffixes, root), but not to the following suffixes. As we have seen in section 9.4.2, this is not the case in Turkana, where it is the rightmost suffix that is always preserved faithfully. Other potential examples of regressive harmony include: Futankooore Pulaar (Paradis 1992), Karajá (Ribeiro 2002), Assamese, and Bengali (Mahanta 2007). These all show a different pattern, in which a suffix triggers regressive harmony of all preceding morphemes, but not the following suffixes. As an example, let us look at some data from Futankooore Pulaar (317). Suffixes affect the root, such that a lax suffix vowel is preceded by a lax root vowel, whereas a tense suffix vowel is preceded by a tense root vowel, as in (317-a). The suffix does not trigger progressive harmony in the following suffix, as in (317-b). A tense suffix vowel affects only preceding vowels, regardless whether they belong to a root or a suffix. In this language, all words are polymorphemic (roots are always followed by at least one suffix).

(317) Futankooore Pulaar ATR harmony (Paradis 1992:87,90)

|    |                                                                |                   |                    |                      |
|----|----------------------------------------------------------------|-------------------|--------------------|----------------------|
| a. | Suffix affects root                                            |                   |                    |                      |
|    | <u>k</u> εεr-ɔn                                                | ‘boundary-DIM.PL’ | <u>k</u> eer-el    | ‘boundary-DIM.SG’    |
|    | <u>l</u> εf-ɔn                                                 | ‘ribbon-DIM.PL’   | <u>l</u> ef-ol     | ‘ribbon’             |
|    | <u>c</u> εεlt-ɔn                                               | ‘cut-DIM.PL’      | <u>c</u> eeelt-el  | ‘cut-DIM.SG’         |
| b. | Suffix affects preceding morphemes, but not following suffixes |                   |                    |                      |
|    | <u>h</u> εl-dε                                                 | ‘to break’        | <u>h</u> el-ir-dε  | ‘to break with’      |
|    | <u>β</u> εt-dε                                                 | ‘to weigh’        | <u>β</u> et-ir-dε  | ‘to weigh with’      |
|    | <u>d</u> ɔkk-ɔ                                                 | ‘one-eyed person’ | <u>d</u> ɔkk-id-dε | ‘to become one-eyed’ |
|    | <u>d</u> ɔg-ɔ-w-ɔn                                             | ‘runner-DIM-PL’   | <u>d</u> og-ɔɔ-ru  | ‘runner’             |

Futankooore Pulaar serves as a representative case of all languages with regressive, but not progressive, vowel harmony. Given a large number of languages with vowel harmony, the fact that only very few languages show this pattern is telling. There are two solutions to make these few languages consistent with the generalizations regarding the vast majority of vowel harmony patterns, which are all bidirectional.

The first option is to say that these languages are not cases of vowel harmony, but instead cases of umlaut. Since we know that umlaut can be iterative, there is no way to distinguish what is traditionally considered umlaut from languages like Pulaar that have been traditionally described as vowel harmony.

The second option is to abandon the restriction on bidirectionality in vowel harmony. That is, unidirectional vowel harmony is a possible, and indeed an attested pattern. A possible challenge for this generalization is that all reported unidirectional vowel harmonies are regressive, never progressive. That is, vowel harmony can be triggered by a suffix, but not by a prefix. However, since suffixation is much more common than prefixation, it is more likely to encounter a language with harmony triggered by a suffix than by a prefix. Hence, the fact that there are no unambiguous cases of languages with progressive harmony is not to be taken as a definite evidence that such languages are impossible. For opposing views, see Baković (2000); Hyman (2002/to appear, 2008); Krämer (2003); Mahanta (2007); Finley (2008).

I remain agnostic with respect to directionality in vowel harmony and will not account for the possible absence of progressive vowel harmony. This is particularly important since other types of assimilation are not restricted in terms of directionality, as we have seen throughout this thesis. For example, umlaut can be both progressive from prefix to root (as in Chamorro, Topping 1968; Chung 1983) and regressive from suffix to root (as in Icelandic, section 4.3). Similarly, nasal harmony in Sundanese is progressive, in Capanahua regressive and in Ikwere bidirectional.

Now that I have discussed cross-linguistic patterns in terms of root-dominance and directionality, I move on to an account of root-controlled harmony in Twi.

### 9.5.2 Twi

In this section, I introduce root faithfulness and demonstrate its effects in a root-controlled language. I will focus on three predictions. First, root faithfulness protects roots, but not affixes, segments from some effects of alignment constraints. Second, root faithfulness protects root segments from the effects of affix segments. Third, root faithfulness protects prefixes from effects of suffixes and vice versa.

Recall the Twi vowel harmony facts from section 3.2.2. Twi has tongue root harmony, which affects all vowels within a word. The tongue root value of all vowels is determined by vowels in the root. Because Twi has prefixes and suffixes,

the pattern appears bidirectional. In short, Twi has root-controlled tongue root harmony.

(318) Tongue root harmony in Twi (Berry 1957:127–128,130)

|      |                |              |                    |
|------|----------------|--------------|--------------------|
| biri | ‘black’        | o-biri       | ‘3P-black’         |
|      |                | wu-biri      | ‘2P-black’         |
| biri | ‘red’          | ɔ-biri       | ‘3P-red’           |
|      |                | wɔ-biri      | ‘2P-black’         |
| se   | ‘say’          | o-se         | ‘3P-say’           |
|      |                | o-be-se      | ‘3P-FUT-say’       |
| sɛ   | ‘resemble’     | ɔ-sɛ         | ‘3P-resemble’      |
|      |                | ɔ-bɛ-sɛ      | ‘3P-FUT-resemble’  |
| firi | ‘lend, borrow’ | mi-be-firi-i | ‘1P-FUT-borrow-it’ |
| firi | ‘fail, miss’   | mi-be-firi-i | ‘1P-FUT-miss-it’   |

In section 3.2.2, I analyzed Twi as spreading of [rtr], which I will also follow here. The relevant alignment constraints are  $*\omega([rtr], \text{vowel})$  and  $*\omega(\text{vowel}, [rtr])$ . Spreading in Twi is bidirectional, which means that both alignment constraints outrank  $\text{MAXLINK}[rtr]$  and  $\text{DEPLINK}[rtr]$ . Root vowels are preserved by a positional faithfulness constraint to roots. Such a constraint has been put forth in McCarthy & Prince (1995), Beckman (1998). The present approach takes a slightly different path. Association by Proxy (38) states that association can be an indirect relation. That is, a feature is directly associated with a root node, whereas a feature is indirectly associated with a morphological or prosodic domain or another feature. With respect to (morphological) roots, it holds that if a feature [f] is associated with any segment of a root, [f] is also associated with the root. The constraint  $\text{MAXLINK-ROOT}[rtr]$  in (319) is violated if [rtr] is linked to some segments of the root in the input, but [rtr] is not linked to any of the segments of the root in the output. Note that the constraint below slightly differs from other positional faithfulness constraints in this chapter. This is because what is relevant in root faithfulness is not the relationship between a root node and a feature, but rather a morphological domain and a feature. We have seen that alignment constraints can refer to both segments and domains, so it is entirely consistent with the current approach to make use of the same distinction in positional faithfulness constraints.

(319)  $\text{MAXLINK-ROOT}[rtr]$   
 Let  $root_i \mathfrak{R} root_o$ .  
 Assign a violation mark, iff  $root_i$  is fully associated with the feature [rtr]  
 and  $root_o$  is not.

I now demonstrate the effect of  $\text{MAXLINK-ROOT}[rtr]$ . Tableau (320) contains an input root with [rtr]. As long as one segment is linked to [rtr] in the input, the



output will have all vowels linked to that feature. Four candidates are considered. The faithful candidate (a) violates alignment, whereas the delinking candidate (b) violates the high ranked positional faithfulness constraint. Candidate (c) shows spreading within the root only, which does not violate the positional faithfulness constraint MAXLINK-ROOT[rtr]. This candidate still violates alignment, whereas the winning candidate (d) does not.

(320) mibefiri '1P-FUT-miss-it'

|                                                                                                          | MAXLINK-ROOT[rtr] | * $\omega$ (vow, <sub>[rtr]</sub> ) | * $\omega$ ([rtr],vow) | DEPLINK[rtr] | MAXLINK[rtr] |
|----------------------------------------------------------------------------------------------------------|-------------------|-------------------------------------|------------------------|--------------|--------------|
| / m i - b e - √ f i r i - i /                                                                            |                   |                                     |                        |              |              |
| a. m i b e f i r i i                                                                                     |                   | *(!)**                              | *(!)                   |              |              |
| b. m i b e f i r i i                                                                                     | *!                |                                     |                        |              | *            |
| c. m i b e f i r i i                                                                                     |                   | *(!)*                               | *(!)                   | *            |              |
| d.  m i b e f i r i i |                   |                                     |                        | *****        |              |

Given Richness of the Base, inputs with an [rtr] affix also need to be considered. Twi exhibits a root-controlled pattern, which means that [rtr] spreads to the whole word if originating from the root, whereas any suffix [rtr] delinks (and does not spread to the root or other affixes). Tableau (321) shows an input with an instance of [rtr] associated with the suffix. Such an input needs to be considered given Richness of the Base. The faithful candidate (a) fatally violates the regressive alignment constraint. The winning candidate (b) with delinking violates the low ranked MAXLINK[rtr], but satisfies all other constraints. Candidate (c) has transparency in the root. Skipping the root, however, is not enough, since

alignment is still not satisfied. Candidate (d) with total spreading fatally violates  $\text{DEPLINK}[\text{rtr}]$ .

(321) mibefirii ‘1P-FUT-borrow-it’

|                                   | $\text{MAXLINK-ROOT}[\text{rtr}]$ | $*\omega(\text{vow}, [\text{rtr}])$ | $*\omega([\text{rtr}], \text{vow})$ | $\text{DEPLINK}[\text{rtr}]$ | $\text{MAXLINK}[\text{rtr}]$ |
|-----------------------------------|-----------------------------------|-------------------------------------|-------------------------------------|------------------------------|------------------------------|
| / m i - b e - √ f i r i - i /     |                                   |                                     |                                     |                              |                              |
| a. m i b e f i r i i              |                                   | *!***                               |                                     |                              |                              |
| b. $\leftarrow$ m i b e f i r i i |                                   |                                     |                                     |                              | *                            |
| c.                                |                                   | *(!)*                               | *(!)*                               | **                           |                              |
| d.                                |                                   |                                     |                                     | *!***                        |                              |

Root faithfulness works exactly like other types of positional faithfulness in that a feature spreads from the prominent position, but delinks in all other instances. Hence, all types of assimilation reviewed in this chapter are directly parallel, regardless of what the spreading feature, the domain of positional faithfulness, or the targeted structure is.

## 9.6 Summary

In this chapter, I analyze positional effects in feature spreading. I make use of Positional Faithfulness (Beckman 1997, 1998), which I modify in two ways. First,

I show that positional MAXLINK[f]—rather than IDENT(f)—is sufficient to account for assimilation and dissimilation. Second, I provide evidence for Positional Faithfulness to the rightmost segment of a particular kind within a domain.

The advantages of using positional MAXLINK[f] are both formal and typological. The formal advantage is in that the definition is not disjunctive. The constraint is violated only by delinking, but not by linking. Positional MAXLINK[f] and alignment are satisfied by spreading from a prominent position, but delinking from other positions. Such a grammar fits the description of positional effects perfectly. The advantage of the current approach is a typological connection between positional effects, pure assimilation and dissimilation. I complement the typologies discussed in the previous chapters by considering positional faithfulness constraints of different types (presonorant, final, rightmost, and root).

The second contribution is more specific. I argued for positional faithfulness constraints specific to the rightmost segment within a domain. These constraints can apply to the absolutely final segment or to the rightmost segment of a particular type. The example of the first kind is found in Hungarian, which has voicing assimilation in the phrase-final position. The second kind is supported by three further patterns: Chumash consonant harmony, Turkana vowel harmony, and Tashlhiyt Berber labial dissimilation. In Chumash, for example, the trigger does not need to be absolutely final within a word. What seems to matter is that the sibilant closest to the right edge of a word is preserved faithfully.

To conclude, positional faithfulness constraints have a vital role in assimilation. They are required in addition to alignment, agreement, feature co-occurrence, and general faithfulness constraints that are independently needed for other types of assimilation.



# Chapter 10

## Conclusions

### 10.1 Summary

The basic aim of this dissertation is to formalize a universal, restrictive and unified approach to all assimilation patterns by making use of two major phonological theories: Autosegmental Phonology and Optimality Theory. I take much from the previous proposals in terms of representations and constraints. For example, assimilation is represented as feature spreading, which is governed by constraint interaction. However, I also argue for significant modifications. On the one hand, I review the data showing that assimilation is a directional phenomenon and that it involves three categories. In response, I propose that assimilation is driven by a single class of categorical markedness constraints. These constraints are the principal mechanism that determines the relationships between the three categories of assimilation, and their other properties, including directionality and locality. On the other hand, I propose that the concept of association should be modified to represent different kinds of relationships. For instance, association between a feature and a trigger represents a different relationship than association between a feature and a target or a transparent segment. These conclusions are made explicit in eight steps, which constitute individual chapters of this dissertation.

Chapter 2 presents the data indicating that assimilation consists of three fundamental elements: a spreading feature, a targeted structure, and a domain. Assimilation can be characterized as spreading a feature to targeted structures within a domain. The most neutral way of capturing the interaction of these three elements is by incorporating them into a single markedness constraint. I take on a proposal by Hyde (2001, 2002, 2008) and formalize alignment constraints specific to features. Alignment constraints penalize triplets of a spreading feature, a targeted structure and a domain, when certain conditions are met. One advantage of the

new alignment constraints is that they are formally categorical, while maintaining the effect of standard gradient alignment constraints.

The predictive power of alignment constraints becomes more apparent in chapter 3. The targeted structure has the sole role of selecting the targets within the domain of an alignment constraint. For example, if a root node is the targeted structure, then all segments are targeted. If a vowel is the targeted structure, then only vowels are targeted. In a broader context, the targeted structure replaces rule-based and other representational accounts of locality in assimilation. As a case study, I present RTR harmony, with root nodes, vowels and open vowels as targeted structures. The approach can be extended to other spreading features. This way alignment constraint typologies can rule out many unattested patterns, such as spreading of a place feature to consonants across vowels. Alignment constraints turn out to be even more powerful, since they can also deal with dissimilation, derived environment effects, and metaphony.

In chapter 4, I move on to the distinction between two types of targets. Regular targets are affected by the spreading feature, but have no effect on its further propagation. Icy targets are also subject to assimilation, but at the same time block further spreading. The principal evidence for icy targets comes from Icelandic u-umlaut, which involves an independent process that changes icy targets into regular targets, which no longer display the blocking behavior. Many other languages exhibit icy targets in various assimilation patterns and have been analyzed at various parts of the dissertation. They include vowel harmony (Kachin Khakass), consonant harmony (Sanskrit), and nasal harmony (Ikwere, Mòbà). The very existence of icy targets has a strong theoretical consequence for feature spreading. A model that has only one type of association treats all targets equally. The simplest way to distinguish targets among themselves is by restricting branching to be maximally binary. Spreading to more than one target creates recursive feature nodes which are maximally binary branching themselves.

At first, such a modification seems rather radical. However, binary branching in feature spreading is not radical and at the same time necessary to account for the data. First, binary branching has been an alternative approach to feature spreading from the very beginnings of Autosegmental Phonology. Because icy targets were not brought to light at the time, the simplest model with unrestricted branching eventually prevailed. Second, binary branching is well established in Metrical Theory and syntax. Having a single concept of association for all parts of phonology and linguistics is more parsimonious than the alternative. Third, binary branching predicts icy targets. This is because binarity is complemented by another modification of classical association—headedness. Of the two association lines linked to the same feature node one expresses more prominence than the other. The prominent constituent root node is a head of a feature. Icy targets can

be associated with a feature, but cannot be its heads, which is why they terminate further spreading. Headedness is found throughout phonology and linguistic theory in general. Thus, it is not surprising that there is evidence for headedness in feature spreading, too.

Binary and headed domains can be extended from the distinction between non-final and final (or icy) targets to other types of segments. In chapter 5 I review evidence that transparent segments are also associated with a feature. Phonetic studies show that transparent segments are affected by the spreading feature. As regards phonology, transparency is a marked configuration. One way to see that directly is by looking at processes that have multiple available targets but will target a single target (because of other restrictions). By default, the target closest to the trigger is chosen, avoiding any unnecessary transparent segments. In response, I propose that all spreading is strictly local, but that spreading is more prominently realized on some segments compared to others. This situation can be represented in a hierarchical model of feature spreading. Association between a feature and a target differs from the association between a feature and a transparent segment. This representational difference is mirrored by constraints. Transparent segments do not satisfy alignment constraints and do not violate faithfulness constraints. Conversely, targets satisfy alignment constraints and violate faithfulness constraints. There are at least two advantages of this approach compared to the predecessors. First, there is a formal relationship between alignment constraints, targets and transparent segments. Second, not all transparent segments are equally marked. This is because some transparent segments violate more alignment constraints than others. In vowel harmony, for example, transparent consonants are less marked than transparent vowels. In other words, a transparent vowel implies transparent consonants, but not vice versa.

Chapter 6 contrasts transparency from blocking. I follow the classic proposals in that blocking is attributed to a high ranked feature co-occurrence constraint. Such a constraint is satisfied only by a segment that is not associated with a spreading feature. Since no skipping is allowed, spreading is terminated instead. Blockers do not violate a feature co-occurrence constraint, while transparent segments and targets do. The advantage of this approach is that blocking is entirely divorced from transparency. This is a welcome prediction that is supported by a number of case studies. In nasal harmony, for instance, sonorants are often blockers, but are never transparent.

Chapter 7 further extends the hierarchy of feature spreading to triggers. Some languages display segments that fail to trigger spreading, but undergo and propagate spreading initiated by a different trigger. This second behavior is surprising, because we would expect blocking, as if these failed triggers were icy targets. However, this is not the case. The solution lies in constraints that refer exclu-

sively to triggers. Representationally, triggers have a unique representation that distinguishes them from all targets.

The remaining two chapters look at two other variables that can interact with assimilation. Chapter 8 focuses on parasitic assimilation. In parasitic assimilation, spreading of one feature depends on another feature, which must be identical on both the trigger and the target. This pattern provides evidence for another markedness constraint. Agreement constraints are frequently used in the literature. I provide an update so that they can be used in combination with alignment constraints. The advantage of this approach is that the new agreement constraints require no reference to adjacency or neighborhood, which is a problematic part of the classic definition. As a consequence, agreement constraints can trigger spreading over segments that are normally targets of alignment constraints. Such long-distance effects are confirmed by rounding and consonant harmony. This solution suggests that the two patterns are more alike than previously assumed.

The other phenomenon that can interact with alignment-based spreading are positional effects, analyzed in chapter 9. In some languages, only certain positions are immune to effects of alignment. Prominent positions may be protected by the effects of high ranked positional faithfulness constraints (Beckman 1997, 1998; Rubach 2008). The current analysis diverges in two ways from the previous proposals. First, I make use of a positional variant of MAXLINK[f]. One advantage of this approach is a direct connection between pure assimilation, positional effects in assimilation, and dissimilation. Second, I propose an extension of positional faithfulness to the rightmost segment within a domain. The support comes from languages with voicing assimilation, consonant, and vowel harmony.

To conclude, the current approach takes many elements of previous theories both in terms of representations and constraints, but uses them in a fundamentally different way. This way it is possible to fill the gaps in the theory and provide a unified analysis. In addition, the present approach also makes stronger connections with prosody, phonetics, and other fields of linguistic theory.

## 10.2 Contributions

This dissertation builds on the classic OT approaches to assimilation. A careful review of previously underreported data, however, led to a theory of assimilation that significantly diverges from the established approaches. The contributions are both empirical and theoretical. In what follows, I give a short overview of the principal results.



### **Some targets are blockers.**

Most previous approaches to assimilation assume that the sets of blockers and targets are disjunctive: a segment can be either a target or a blocker, but never both at the same time. This is related to the compatibility between the assimilatory and other features. When a segment contains an incompatible feature, it will act as a blocker. If the opposite is true and a segment contains only compatible features, it will be a target. Chapter 4 identifies a new class of segments that are both targets and blockers—*icy targets*.

### **Assimilation and prosody are more alike than previously assumed.**

The very existence of icy targets is surprising and appears to be inconsistent with the standard assumptions about assimilation. In particular, what appears to be insufficient is the fact that features can be either compatible (as in targets) or entirely incompatible (as in blockers). What is required for an analysis of icy targets is a *partial* incompatibility with the assimilatory feature. One way to capture this situation is to say that there are at least two different kinds of relationships between a feature and a segment. I make use of an early autosegmental model that distinguishes headed and non-headed segments. The main prediction is that some segments cannot be heads, but can be dependents of the assimilatory feature.

This model suggests that assimilation is organized in a way that is similar to prosodic hierarchy. Both assimilation and prosody show binary domains and headedness. The remaining differences have to do with the fact that the prosodic organization generally increases contrast between adjacent units, whereas assimilation neutralizes contrast within a domain. The best way to increase contrast between adjacent units is to have a sequence of peaks and troughs, which can be formalized in terms of alternating heads and dependents. On the other hand, the best way to neutralize contrast is to say (i) that heads are stronger neutralizers than dependents and (ii) that heads are adjacent. Adjacent heads are possible in a model with recursive (or overlapping) binary domains. In short, prosody and assimilation exhibit the same structures, even though their distributions differ.

### **Assimilation and dissimilation are related.**

In this dissertation, assimilation is driven by a single class of markedness constraints, which interact with other constraints. Depending on the ranking of faithfulness constraints, some rankings prefer assimilation whereas others prefer dissimilation. This allows for a unified analysis of assimilation and dissimilation. This idea has been previously advocated by some phonetically oriented literature (e.g. Ohala 1981). The current approach allows for a formal implementation within Autosegmental Phonology and OT.

**All assimilation patterns can be analyzed using a single representational model and a small set of OT constraints.**

Assimilation is a cross-linguistically frequent and varied phonological pattern. This dissertation uses a simple representational model and a very small set of constraints to capture very different types of assimilation. The current representational model resembles the early versions of feature spreading in Autosegmental Phonology. The main idea boils down to a single restriction: all branching is maximally binary. Binary constituents are ubiquitous elsewhere in phonology and linguistics.

As regards the constraints, assimilation is driven by a single class of markedness constraints. I make use of the revised alignment constraints (Hyde 2001, 2002, 2008) and adapt them to segmental features. Assimilation surfaces when the alignment constraints are ranked above the faithfulness constraints against adding association lines, but below the faithfulness constraint against removing association lines. Spreading can be terminated by a domain edge or a segmental blocker. Blockers come in two varieties: some of them are targets themselves, whereas other are not. The former are enforced by constraints on feature heads, whereas the latter are enforced by feature co-occurrence constraints.

The two remaining constraint families limit assimilation to specific pairs of triggers and targets or to specific positions. I redefine agreement constraints such that they inhibit spreading when the target is dissimilar to the trigger. When an agreement constraint outranks an alignment constraint, the resulting pattern is parasitic assimilation. Positional faithfulness is another class of constraints that have been used extensively in the literature (Beckman 1997, 1998). I use a new, non-disjunctive variety of these constraints, and propose a new position that they can refer to.

In short, by using a small set of constraints and a simple representational model it is possible to capture all assimilation types. This dissertation looks at nasal, vowel, consonant harmony, local consonant assimilation, vowel-consonant and consonant-tone interactions.

**Transparency and blocking are fundamentally different.**

One central claim of this dissertation is that transparency and blocking have fundamentally incompatible mechanisms. This argument stems from a careful examination of the data. For any given feature, the attested combinations of transparent segments are very different from the attested combinations of blockers. For example, no case of nasal harmony (triggered by a nasal vowel) shows transparent sonorants, whereas there are some languages that show blocking sonorants. Another example comes from RTR spreading, which shows an implicational pattern: transparent vowels imply transparent consonants, and transparent non-high vow-

els imply transparent high vowels. Blocking, on the other hand, shows a markedly different pattern. Some cases of RTR vowel harmony show blocking by high vowels, whereas consonants are not blockers. What these data suggest is that blocking and transparency cannot be attributed to the same class of constraints.

I follow the traditional approach in that blocking is due to feature co-occurrence constraints. The treatment of transparency, however, is related to alignment constraints. More specifically, alignment constraints with a particular feature come with a set of possible targeted structures. Transparent segments are those segments that lack the relevant targeted structures. The advantage of this approach is two-fold. First, transparency is entirely divorced from blocking, which gets a better empirical coverage. Second, transparency is not a marked configuration per se, but is tied to a particular assimilatory feature. For example, alignment constraints with [RTR] as the assimilatory feature, have root nodes and vowels as the targeted structures, but not consonants. This excludes a pattern in which vowels, but not consonants, are transparent. Put differently, some transparent segments are more marked than others.

### **Parasitic vowel harmony and consonant harmony are related.**

The idea that parasitic vowel harmony and consonant harmony can be seen as two sides of the same coin has been first noted by Wayment (2009). When assimilation is parasitic, a trigger and its target must agree in some other feature. The novelty of the current approach is the connection between parasitic assimilation and non-parasitic assimilation. Both types are driven by alignment constraints. However, alignment constraints have no say in what segment triggers assimilation. Parasitic assimilation is enforced by modified agreement constraints that refer to two features. Another contribution is the idea that agreement and alignment constraints can interact with other constraints, which means that parasitism may be partially obscured. For example, constraints on heads may additionally inhibit assimilation from some triggers but not from others.



# References

- Abondolo, Daniel Mario (1988). *Hungarian Inflectional Morphology*. Budapest: Akadémiai Kiadó.
- Ajíbóyè, Oládíipò & Douglas Pulleyblank (2008). Mòbà nasal harmony. Ms., University of Lagos and University of British Columbia.
- Akinlabi, Akinbiyi (1996). Featural affixation. *Journal of Linguistics* **32**. 239–289.
- Alderete, John (1997). Dissimilation as local conjunction. In Kiyomi Kusumoto (ed.) *Proceedings of NELS 27*, Amherst, MA: GLSA. 17–31. Available on Rutgers Optimality Archive, ROA 175, <http://roa.rutgers.edu>.
- Alderete, John (2001). Dominance effects as trans-derivational anti-faithfulness. *Phonology* **18**. 201–253.
- Allen, W. S. (1951). Aspects of retroflexion and aspiration in Sanskrit. *Bulletin of the School of Oriental and African Studies, University of London* **13**. 939–946.
- Anderson, Gregory D. S. (1998). Historical aspects of Yakut (Saxa) phonology. *Turkic Languages* **2**. 1–32.
- Anderson, John Mathieson & Colin J. Ewen (1987). *Principles of Dependency Phonology*. Cambridge: Cambridge University Press.
- Anderson, Lloyd B. (1975). *Phonetic and Psychological Explanations for Vowel Harmony, Especially in Finnish*. Ph.D. dissertation, University of Chicago, Chicago.
- Anderson, Lloyd B. (1980a). Using asymmetrical and gradient data in the study of vowel harmony. In Robert Vago (ed.) *Issues in vowel harmony*, Amsterdam: John Benjamins. 271–340.
- Anderson, Stephen R. (1972). Icelandic u-umlaut and breaking in a generative grammar. In Evelyn Scherabon Firchow, Kaaren Grimstad, Nils Hasselmo &

- Wayne A. O'Neil (eds.) *Studies for Einar Paugen: Presented by friends and colleagues*, The Hague, Paris: Mouton de Gruyter. 13–30.
- Anderson, Stephen R. (1974). *The Organization of Phonology*. New York, San Francisco, London: Academic Press.
- Anderson, Stephen R. (1976a). Nasal consonants and the internal structure of segments. *Language* **52**. 326–344.
- Anderson, Stephen R. (1976b). On the conditioning the Icelandic u-umlaut. *Language Sciences* **40**. 26–27.
- Anderson, Stephen R. (1980b). Problems and perspectives in the description of vowel harmony. In Robert Vago (ed.) *Issues in vowel harmony*, Amsterdam: John Benjamins. 1–48.
- Anderson, Stephen R. & Gregory K. Iverson (1976). Icelandic u-umlaut: An exchange of views. *Language Sciences* **42**. 28–34.
- Andrzejewski, B. W. (1955). The problem of vowel representation in the Isaaq dialect of Somali. *Bulletin of the School of Oriental and African Studies, University of London* **17**. 567–580.
- Anttila, Arto (2002). Morphologically conditioned phonological alternations. *Natural Language and Linguistic Theory* **20**. 1–42.
- Applegate, Richard Brian (1972). *Inseño Chumash Grammar*. Ph.D. dissertation, University of California, Berkley, Berkeley, CA.
- Archangeli, Diana (1984). *Underspecification in Yawelmani Phonology and Morphology*. Ph.D. dissertation, Massachusetts Institute of Technology, Cambridge.
- Archangeli, Diana (1985). Evidence for coplanar representation in nonlinear phonology. *Linguistic Inquiry* **16**. 335–372.
- Archangeli, Diana (1988). *Underspecification in Yawelmani Phonology and Morphology*. New York: Garland.
- Archangeli, Diana & Douglas Pulleyblank (1987). Minimal and maximal rules: Effects of tier scansion. In *Proceedings of NELS 17*, Amherst: GLSA, University of Massachusetts. 16–35.
- Archangeli, Diana & Douglas Pulleyblank (1989). Yoruba vowel harmony. *Linguistic Inquiry* **20**. 173–217.

- Archangeli, Diana & Douglas Pulleyblank (1994). *Grounded Phonology*. Cambridge, MA: MIT Press.
- Archangeli, Diana & Douglas Pulleyblank (2002). Kinande vowel harmony: domains, grounded conditions and one-sided alignment. *Phonology* **19**. 139–188.
- Archangeli, Diana & Douglas Pulleyblank (2007). Harmony. In Paul de Lacy (ed.) *The Cambridge Handbook of Phonology*, Cambridge: Cambridge University Press. 353–378.
- Archangeli, Diana & Keiichiro Suzuki (1997a). Menomini vowel harmony: O(pacity) and T(ransparency) in OT. In Keiichiro Suzuki & Dirk Elzinga (eds.) *Proceedings of the 1995 Southwestern Workshop on Optimality Theory*, Tucson, AZ: Coyote Working Papers, University of Arizona. 1–17.
- Archangeli, Diana & Keiichiro Suzuki (1997b). The Yokuts challenge. In Iggy Roca (ed.) *Derivations and constraints in phonology*, Oxford: Oxford University Press. 197–226.
- Árnason, Kristján (1992). Problems in the lexical phonology of Icelandic. In Wolfgang U. Dressler, Hans C. Luschützky, Oskar E. Pfeiffer & John R. Rennison (eds.) *Phonologica 1988*, Cambridge: Cambridge University Press. 5–14.
- Arsenault, Paul & Alexei Kochetov (to appear). Retroflex harmony in Kalasha: Agreement or spreading? In *Proceedings of NELS 39*, Amherst: GLSA, University of Massachusetts. Available on Rutgers Optimality Archive, ROA 1023, <http://roa.rutgers.edu>.
- Awobuluyi, A. Oladele (1967). Vowel and consonant harmony in Yoruba. *Journal of African Languages* **6**. 1–8.
- Awobuluyi, A. Oladele & Ayo Bamgboṣe (1967). Two views of vowel harmony in Yoruba. *Journal of African Languages* **6**. 274–277.
- Baković, Eric (2000). *Harmony, Dominance, and Control*. Ph.D. dissertation, Rutgers University. Available on Rutgers Optimality Archive, ROA 360, <http://roa.rutgers.edu>.
- Baković, Eric (2002). Vowel harmony and cyclicity in Eastern Nilotic. In *Proceedings of BLS 27*, Berkeley, CA: Berkeley Linguistics Society. 1–27.
- Baković, Eric (2007). Local assimilation and constraint interaction. In Paul de Lacy (ed.) *The Cambridge Handbook of Phonology*, Cambridge: Cambridge University Press. 335–352.

- Bamgboṣe, Ayo (1966). *A Grammar of Yoruba*. Cambridge: Cambridge University Press.
- Bamgboṣe, Ayo (1967). Vowel harmony in Yoruba. *Journal of African Languages* **6**. 268–273.
- Barnes, Janet (1996). Autosegments with three-way contrasts in Tuyuca. *International Journal of American Linguistics* **62**. 31–58.
- Bashir, Elena (2003). Dardic. In George Cardona & Dhanesh Jain (eds.) *The Indo-Iranian Languages*, London: Routledge. 818–894.
- Battistella, Ed (1982). More on Hungarian vowel harmony. *Linguistic Analysis* **9**. 95–118.
- Bavin Woock, Edith & Michael Noonan (1979). Vowel harmony in Lango. *Canadian Journal of Linguistics* **15**. 20–29.
- Becker, Michael (2007). Tone licensing and categorical alignment in Serbo-Croatian. In Leah Bateman, Michael O’Keefe, Ehren Reilly & Adam Werle (eds.) *University of Massachusetts Occasional Papers in Linguistics 32: Papers in Optimality Theory III*, Amherst: GLSA, University of Massachusetts. 1–19.
- Beckman, Jill N. (1997). Positional faithfulness, positional neutralization and Shona vowel harmony. *Phonology* **14**. 1–46.
- Beckman, Jill N. (1998). *Positional Faithfulness*. Ph.D. dissertation, University of Massachusetts Amherst, Amherst. Available on Rutgers Optimality Archive, ROA 234, <http://roa.rutgers.edu>.
- Beckman, Jill N., Laura Walsh & Suzanne Urbanczyk (eds.) (1995). *Papers in Optimality Theory*. University of Massachusetts Occasional Papers 18, University of Massachusetts, Amherst: GLSA.
- Beddor, Patrice Speeter, James D. Harnsberger & Stephanie Lindemann (2002). Language-specific patterns of vowel-to-vowel coarticulation: acoustic structures and their perceptual correlates. *Journal of Phonetics* **30**. 591–627.
- Beeler, M. S. (1970). Sibilant harmony in Chumash. *International Journal of American Linguistics* **36**. 14–17.
- Benua, Laura (1997). *Transderivational Identity: Phonological Relations between Words*. Ph.D. dissertation, University of Massachusetts Amherst, Amherst.



- Benus, Stefan (2005). *Dynamics and Transparency in Vowel Harmony*. Ph.D. dissertation, New York University, New York.
- Benus, Stefan & Adamantios I. Gafos (2007). Articulatory characteristics of Hungarian ‘transparent’ vowels. *Journal of Phonetics* **35**. 271–300.
- Berry, J. (1957). Vowel harmony in Twi. *Bulletin of the School of Oriental and African Studies, University of London* **19**. 124–130.
- Bessell, Nicola J. (1998). Local and non-local consonant-vowel interaction in Interior Salish. *Phonology* **15**. 1–40.
- Bickmore, Lee (1997). Problems in constraining high tone spread in Ekegusii. *Lingua* **102**. 265–290.
- Bickmore, Lee (2007). *Cilungu Phonology*. Stanford, CA: CSLI Publications.
- Binnick, Robert I. (1969). Non-high neutral vowels in modern Mongolian. In *Chicago Linguistic Society (CLS) 5*, Chicago: Chicago Linguistic Society. 295–301.
- Binnick, Robert I. (1980). The underlying representation of harmonizing vowels: evidence from modern Mongolian. In Robert Vago (ed.) *Issues in vowel harmony*, Amsterdam: John Benjamins. 113–134.
- Blaho, Sylvia (2002). /j/, /v/ and /h/ in Hungarian voice assimilation – an OT account. In Marjo van Koppen, Joanna Sio & Mark de Vos (eds.) *Proceedings of ConSOLE X*. Leiden: Leiden University, 17–31.
- Blaho, Sylvia (2008). *The syntax of phonology: A radically substance-free approach*. Ph.D. dissertation, University of Tromsø, Tromsø.
- Bloomfield, Leonard (1962). *The Menomini Language*. New Haven, CT: Yale University Press.
- Bloomfield, Leonard (1975). *The Menomini Lexicon*. New Haven, CT: Milwaukee Public Museum Press.
- Blumenfeld, Lev A. (2006). *Constraints on phonological interactions*. Ph.D. dissertation, Stanford University, Palo Alto, CA. Available on Rutgers Optimality Archive, ROA 877, <http://roa.rutgers.edu>.
- Bodomo, Adams (1997). *The Structure of Dagaare*. Stanford, CA: CSLI Publications.

- Booij, Geert E. (1984). Neutral vowels and the autosegmental analysis of Hungarian vowel harmony. *Linguistics* **22**. 629–641.
- Boyce, Suzanne E. (1990). Coarticulatory organization for lip rounding in Turkish and English. *Journal of the Acoustical Society of America* **88**. 2584–2595.
- Bradshaw, Mary M. (1997). A phonology-phonetics mismatch: [voice] in consonant-tone interaction. *Studies in Linguistic Sciences* **27**. 17–31.
- Bradshaw, Mary M. (1999). *A Crosslinguistic Study of Consonant-Tone Interaction*. Ph.D. dissertation, Ohio State University, Columbus, OH.
- Broselow, Ellen, Su-I Chen & Marie Huffman (1997). Syllable weight: Convergence of phonology and phonetics. *Phonology* **14**. 47–82.
- Browman, Catherine P. & Louis M. Goldstein (1986). Towards an articulatory phonology. *Phonology Yearbook* **3**. 219–252.
- Browman, Catherine P. & Louis M. Goldstein (1989). Articulatory gestures as phonological units. *Phonology* **6**. 201–251.
- Burzio, Luigi (1994). *Principles of English stress*. Cambridge: Cambridge University Press.
- Burzio, Luigi (2005). Sources of paradigm uniformity. In Laura J. Downing, Tracy Alan Hall & Renate Raffelsiefen (eds.) *Paradigms in Phonological Theory*, Oxford: Oxford University Press. 65–106.
- Bybee, Joan, William Pagliuca & Revere D. Perkins (1990). On the asymmetries in the affixation of grammatical material. In William Croft (ed.) *Studies in Typology and Diachrony*, Amsterdam: Benjamins. 1–42.
- Bye, Patrik (2002). *Virtual Phonology: Rule-Sandwiching and Multiple Opacity in North Saami*. Ph.D. dissertation, University of Tromsø, Tromsø.
- Campbell, Lyle (1980). The psychological and sociological reality of Finnish vowel harmony. In Robert Vago (ed.) *Issues in vowel harmony*, Amsterdam: John Benjamins. 245–270.
- Campbell, Lyle (1981). Generative phonology vs. Finnish phonology: Retrospect and prospect. In D. L. Goyvaerts (ed.) *Phonology in the 1980's*, Ghent: E. Story-Scientia. 147–182.
- Casali, Roderic F. (1995). Labial opacity and roundness harmony in Nawuri. *Natural Language and Linguistic Theory* **13**. 649–663.

- Casali, Roderic F. (2008). ATR harmony in African languages. *Language and Linguistics Compass* **2**. 496–549.
- Cassimjee, Farida & Charles Kisseberth (1989). Shingazidja nominal accent. *Studies in the Linguistic Sciences* **19**. 33–61.
- Cassimjee, Farida & Charles Kisseberth (1998). Optimal Domains Theory and Bantu tonology: A case study from Isixhosa and Shingazidja. In Larry Hyman & Charles Kisseberth (eds.) *Theoretical Aspects of Bantu Tone*, Stanford, CA: CSLI Publications. 33–132. Available on Rutgers Optimality Archive, ROA 176, <http://roa.rutgers.edu>.
- Childers, D. G. & Ke Wu (1991). Gender recognition from speech. Part II: Fine analysis. *The Journal of the Acoustical society of America* **90**. 1841–1856.
- Cho, Young-mee Yu (1991). On the universality of the coronal articulator. In Carole Paradis & Jean-François Prunet (eds.) *Phonetics and Phonology 2: Volume 2. The Special status of Coronals, Internal and External Evidence*, San Diego, CA: Academic Press. 159–179.
- Chomsky, Noam & Morris Halle (1968). *The Sound Pattern of English*. New York, Evanston, London: Harper & Row.
- Chung, Sandra (1983). Transderivational relationships in Chamorro phonology. *Language* **59**. 35–66.
- Clements, George N. (1976/1980). *Vowel Harmony in Nonlinear Generative Phonology*. Bloomington: Indiana University Linguistics Club.
- Clements, George N. (1977). Neutral vowels in Hungarian vowel harmony: an autosegmental interpretation. In Judy Anne Kegl, David Nash & Annie Zaenen (eds.) *Proceedings of NELS 7*, Amherst: GLSA, University of Massachusetts. 49–64.
- Clements, George N. (1984). Principles of tone assignment in Kikuyu. In George N. Clements & John A. Goldsmith (eds.) *Autosegmental Studies in Bantu Tone*, Foris. 281–339.
- Clements, George N. (1985a). Akan vowel harmony: a nonlinear analysis. In D. L. Goyvaerts (ed.) *African Linguistics: Essays in Honor of W. M. K. Semikenke*, Amsterdam: John Benjamins. 55–98.
- Clements, George N. (1985b). The geometry of phonological features. *Phonology* **2**. 225–252.

- Clements, George N. (1991). Place of articulation in consonants and vowels: a unified theory. In *Working Papers of the Cornell Phonetics Laboratory*, Ithaca: Cornell University, vol. 5. 77–123.
- Clements, George N. & Kevin C. Ford (1979). Kikuyu tone shift and its synchronic consequences. *Linguistic Inquiry* **10**. 179–210.
- Clements, George N. & Elizabeth V. Hume (1995). The internal organization of speech sounds. In John A. Goldsmith (ed.) *The Handbook of Phonological Theory*, Blackwell. 245–306.
- Clements, George N. & Sylvester Osu (2002). Explosives, implosives, and non-explosives: the linguistic function of air pressure differences in stops. In Carlos Gussenhoven & Natasha Warner (eds.) *Laboratory Phonology 7*, Berlin: Mouton de Gruyter. 299–350.
- Clements, George N. & Sylvester Osu (2003). Ikwere nasal harmony in typological perspective. In Patrick Sauzet & Anne Zribi-Hertz (eds.) *Typologie des langues d'Afrique et universaux de la grammaire, Vol. II*, Paris: L'Harmattan. 70–95.
- Clements, George N. & Sylvester Osu (2005). Nasal harmony in Ikwere, a language with no phonemic nasal consonants. *Journal of African Languages and Linguistics* **26**. 165–200.
- Clements, George N. & Engin Sezer (1982). Vowel and consonant disharmony in Turkish. In Harry van der Hulst & Norval Smith (eds.) *The Structure of Phonological Representations (Part II)*, Dordrecht: Foris. 213–255.
- Cohen, David A. (1981). Mongolian vowel harmony. In Robert Bley-Vroman & Susan F. Schmerling (eds.) *Texas Linguistic Forum*, Austin, TX: University of Texas, vol. 17. 29–43.
- Cohn, Abigail C. (1990). *Phonetic and Phonological Rules of Nasalization*. Ph.D. dissertation, University of California, Los Angeles, Los Angeles.
- Cohn, Abigail C. (1993a). The status of nasalized continuants. In Marie K. Huffman & Rena A. Krakow (eds.) *Phonetics and Phonology 2: Nasals, Nasalization, and the Velum*, San Diego, CA: Academic Press. 329–367.
- Cohn, Abigail C. (1993b). A survey of the phonology of the feature  $[\pm\text{nasal}]$ . *Working Papers of the Cornell Phonetics Laboratory* **8**. 141–203.
- Cole, Jennifer (1987). *Planar Phonology and Morphology*. Ph.D. dissertation, Massachusetts Institute of Technology, Cambridge.

- Cole, Jennifer & Charles Kisseberth (1995a). Nasal harmony in Optimal Domains Theory. In *Proceedings of the Western Conference on Linguistics*, Fresno, CA: California State University Department of Linguistics, vol. 7. 44–58. Available on Rutgers Optimality Archive, ROA 49, <http://roa.rutgers.edu>.
- Cole, Jennifer & Charles Kisseberth (1995b). An Optimal Domains Theory of vowel harmony. *Studies in Linguistic Sciences* **24**. 101–114. Available on Rutgers Optimality Archive, ROA 22, <http://roa.rutgers.edu>.
- Cole, Jennifer & Loren Trigo (1988). Parasitic harmony. In Harry van der Hulst & Norval Smith (eds.) *Features, Segmental Structure and Harmony Processes (Part II)*, Dordrecht: Foris. 19–38.
- Comrie, Bernard (1981). *The Languages of the Soviet Union*. Cambridge: Cambridge University Press.
- Cook, Eung-Do (1976). Flattening and rounding in Chilcotin velars. In Barbara S. Efrat (ed.) *Victoria Conference on Northwestern Languages*, Victoria: British Columbia Provincial Museum. 15–32.
- Cook, Eung-Do (1983). Chilcotin flattening. *Canadian Journal of Linguistics* **28**. 123–132.
- Cook, Eung-Do (1987). An autosegmental analysis of Chilcotin flattening. In *Chicago Linguistic Society (CLS) 23-2: Parasession on Autosegmental and Metrical Phonology*, Chicago: Chicago Linguistic Society. 51–65.
- Cook, Eung-Do (1993). Chilcotin flattening and autosegmental phonology. *Lingua* **91**. 149–174.
- Crosswhite, Katherine (2001). *Vowel Reduction in Optimality Theory*. New York, London: Routledge.
- Crothers, John & Masayoshi Shibatani (1980). Issues in the description of Turkish vowel harmony. In Robert Vago (ed.) *Issues in vowel harmony*, Amsterdam: John Benjamins. 63–88.
- Davis, Stuart (1995). Emphasis spreading in Arabic and Grounded Phonology. *Linguistic Inquiry* **26**. 465–498.
- de Lacy, Paul (2001). Markedness in prominent positions. In Ora Matushansky, Albert Costa, Javier Martin-Gonzales, Lance Nathan & Adam Szczegielniak (eds.) *MIT Working Papers in Linguistics 40: HUMIT 2000*, Cambridge, MA: MITWPL, vol. 40. 53–66. Available on Rutgers Optimality Archive, ROA 432, <http://roa.rutgers.edu>.

- de Lacy, Paul (2002). The interaction of tone and stress in Optimality Theory. *Phonology* **19**. 1–32.
- de Lacy, Paul (2004). Markedness conflation in Optimality Theory. *Phonology* **21**. 1–55.
- de Lacy, Paul (2006). *Markedness: Reduction and Preservation in Phonology*. Cambridge: Cambridge University Press.
- de Lacy, Paul (2007). The interaction of tone, sonority, and prosodic structure. In Paul de Lacy (ed.) *The Cambridge Handbook of Phonology*, Cambridge: Cambridge University Press. 281–307.
- Demirdache, Hamida (1988). Transparent vowels. In Harry van der Hulst & Norval Smith (eds.) *Features, Segmental Structure and Harmony Processes (Part II)*, Dordrecht: Foris. 39–76.
- Dettweiler, Stephen H. (2000). Vowel harmony and neutral vowels in c’Lela. *Journal of West African Languages* **18**. 3–18.
- Dimmendaal, Gerrit J. (1983). *The Turkana Language*. Dordrecht: Foris.
- Dresher, B. Elan (2009). *The Contrastive Hierarchy in Phonology*. Cambridge: Cambridge University Press.
- Dresher, B. Elan & Harry van der Hulst (1998). Head-dependent asymmetries in phonology: complexity and visibility. *Phonology* **15**. 317–352.
- Dressler, Wolfgang U. (1977). *Grundfragen der Morphologie*. Vienna: Verlag der Österreichischen Akademie der Wissenschaften.
- Dressler, Wolfgang U. (1985). *Morphology: The Dynamics of Derivation*. Ann Arbor, MI: Karoma Publishers.
- Durvasula, Karthik (2009). *Understanding nasality*. Ph.D. dissertation, University of Delaware, Newark, DE.
- Ebbinghaus, Hermann (1913). *On memory: A contribution to experimental psychology*. New York: Teachers College.
- El Medlaoui, Mohamed (1995). *Aspects des représentations phonologiques dans certaines langues Chamito-Sémitiques*. Rabat: Université Mohammed V.
- Engstrand, Olle (1988). Articulatory correlates of stress and speaking rate in Swedish VCV utterances. *The Journal of the Acoustical Society of America* **83**. 1863–1975.

- Erickson, Donna (2002). Articulation of extreme formant patterns for emphasized vowels. *Phonetica* **49**. 134–149.
- Fanti, Renata (1938). Note fonetiche e morfologiche sul dialetto di Ascrea (Rieti). *L'Italia dialettale* **14**. 201–218.
- Fanti, Renata (1939). Note fonetiche e morfologiche sul dialetto di Ascrea (Rieti). *L'Italia dialettale* **15**. 101–135.
- Fanti, Renata (1940). Note fonetiche e morfologiche sul dialetto di Ascrea (Rieti). *L'Italia dialettale* **16**. 77–140.
- Farkas, Donka F. & Patrice S. Beddor (1987). Privative and equipollent backness in Hungarian. In Anna Bosch, Barbara Need & Eric Shiller (eds.) *Chicago Linguistic Society (CLS) 23-2: Parasession on Autosegmental and Metrical Phonology*, Chicago: Chicago Linguistic Society. 91–105.
- Finley, Sara (2008). *Formal and Cognitive Restrictions on Vowel Harmony*. Ph.D. dissertation, Johns Hopkins University, Baltimore, MD. Available on Rutgers Optimality Archive, ROA 489, <http://roa.rutgers.edu>.
- Finley, Sara (2009). Directionality in vowel harmony. *University of Rochester Working Papers in the Language Sciences* **5**. 17–48.
- Flack, Kathryn (2007). Templatic morphology and indexed markedness constraints. *Linguistic Inquiry* **38**. 737–748.
- Flemming, Edward (2001). *Auditory representations in phonology*. New York: Garland.
- Flemming, Edward (2004). Contrast and perceptual distinctiveness. In Bruce Hayes, Robert Kirchner & Donca Steriade (eds.) *Phonetically Based Phonology*, Cambridge: Cambridge University Press. 232–276.
- Fourakis, Marios (1991). Tempo, stress, and vowel reduction in American English. *The Journal of the Acoustical society of America* **90**. 1816–1827.
- Fowler, Carol A. (1981). Production and perception of coarticulation among stressed and unstressed vowels. *Journal of Speech and Hearing Research* **24**. 127–139.
- Fox, Anthony (2000). *Prosodic Features and Prosodic Structures: The Phonology of Suprasegmentals*. Oxford: Oxford University Press.

- Fukazawa, Haruka (1999). *Theoretical Implications of OCP Effects on Features in Optimality Theory*. Ph.D. dissertation, University of Maryland, College Park, College Park, MD. Available on Rutgers Optimality Archive, ROA 307, <http://roa.rutgers.edu>.
- Fukazawa, Haruka, Mafuyu Kitahara & Mitsuhiro Ota (1998). Lexical stratification and ranking invariance in constraint-based grammars. In Catherine Gruber, Derrick Higgins, Kenneth S. Olson & Tamra Wysocki (eds.) *Chicago Linguistic Society (CLS) 34-2: Papers from the Panels: The Status of Constraints, The Acquisition of Spoken Language and Acquisition and the Lexicon*, Chicago: Chicago Linguistic Society. 47–62. Available on Rutgers Optimality Archive, ROA 267, <http://roa.rutgers.edu>.
- Gafos, Adamantios I. (1996). *The articulatory basis of locality in phonology*. Ph.D. dissertation, Johns Hopkins University, Baltimore, MD.
- Gafos, Adamantios I. (1996/1999). *The articulatory basis of locality in phonology*. New York: Garland.
- Gallagher, Gillian (2010a). *The perceptual basis of long-distance laryngeal restrictions*. Ph.D. dissertation, Massachusetts Institute of Technology, Cambridge.
- Gallagher, Gillian (2010b). Perceptual distinctness and long-distance laryngeal restrictions. *Phonology* **27**. 435–480.
- Gallagher, Gillian & Jessica Coon (2009). Distinguishing total and partial identity: evidence from Chol. *Natural Language and Linguistic Theory* **27**. 545–582.
- Gamble, Geoffrey (1978). *Wikchamni grammar*. Berkeley: University of California Press.
- Gay, Thomas (1978). Effect of speaking rate on vowel formant movements. *The Journal of the Acoustical society of America* **63**. 223–230.
- Ghini, Mirco (1993).  $\phi$ -formation in Italian: A new proposal. *Toronto Working Papers in Linguistics* **12**. 41–78.
- Gibson, Courtenay St. John & Catherine Ringen (2000). Icelandic umlaut in Optimality Theory. *Nordic Journal of Linguistics* **23**. 49–64.
- Glenberg, Arthur M. & Naomi G. Swanson (1986). A temporal distinctiveness theory of recency and modality effects. *Journal of Experimental Psychology: Learning, Memory, and Cognition* **12**. 3–15.



- Goldrick, Matthew (2000). Turbid output representations and the unity of opacity. In Masako Hirotsu, Andries Coetzee, Nancy Hall & Ji-Yung Kim (eds.) *Proceedings of NELS 30*, GLSA, University of Massachusetts. 231–245.
- Goldsmith, John A. (1976). *Autosegmental Phonology*. Ph.D. dissertation, Massachusetts Institute of Technology, Cambridge.
- Goldsmith, John A. (1985). Vowel harmony in Khalkha Mongolian, Yaka, Finnish and Hungarian. *Phonology Yearbook* **2**. 253–275.
- Goldsmith, John A. (1990). *Autosegmental and Metrical Phonology*. Oxford: Blackwell.
- Goldsmith, John A. (1993). Harmonic phonology. In John A. Goldsmith (ed.) *The Last Phonological Rule: Reflections on Constraints and Derivations*, Chicago: University of Chicago Press. 21–60.
- Golston, Chris (1996). Direct Optimality Theory: Representation as pure markedness. *Language* **72**. 713–748.
- Gomez-Imbert, Elsa (1997). *Morphologie et phonologie Barasana: approche non-linéaire*. Ph.D. dissertation, Université de Paris 8, Paris.
- Gouskova, Maria (2004). Relational hierarchies in OT: the case of syllable contact. *Phonology* **21**. 201–250.
- Gouskova, Maria (2007). The reduplicative template in Tonkawa. *Phonology* **24**. 367–396.
- Gouskova, Maria (2010). The phonology of boundaries and secondary stress in Russian compounds. *The Linguistic Review* **27**. 387–448.
- Greenberg, Joseph H. (1966). Some universals of grammar with particular reference to the order of meaningful elements. In Joseph H. Greenberg (ed.) *Universals of Language*, Cambridge, MA: MIT Press. 73–113.
- Gregores, Emma & Jorge A. Suarez (1967). *A description of colloquial Guaraní*. The Hague: Mouton de Gruyter.
- Grijzenhout, Janet (1990). Modern Icelandic foot formation. In Reineke Bok-Bennema & Peter Coopmans (eds.) *Linguistics in the Netherlands*, Dordrecht: Foris. 53–62.
- Gurevich, Naomi (2004). *Lenition and Contrast: The Functional Consequences of Certain Phonetically Conditioned Sound Changes*. New York: Garland.

- Hale, Mark, Madelyn Kissock & Charles Reiss (2007). Microvariation, variation, and the features of universal grammar. *Lingua* **117**. 645–665.
- Hale, Mark & Charles Reiss (2000). “Substance abuse” and “dysfunctionalism”: Current trends in phonology. *Linguistic Inquiry* **31**. 157–169.
- Hale, Mark & Charles Reiss (2003). The Subset Principle in phonology: why the tabula can’t be rasa. *Journal of Linguistics* **39**. 219–244.
- Hale, Mark & Charles Reiss (2008). *The Phonological Enterprise*. Oxford: Oxford University Press.
- Hall, Beatrice L., R. M. R. Hall, Martin D. Pam, Amy Myers, Stephen A. Antell & Godfrey K. Cheron (1974). African vowel harmony systems from the vantage point of Kalenjin. *Afrika und Übersee* **57**. 241–267.
- Hall, Tracy Alan (1997). *The Phonology of Coronals*. Amsterdam and Philadelphia, PA: John Benjamins.
- Hall, Tracy Alan & Silke Hamann (2010). On the cross-linguistic avoidance of rhotic plus high front vocoid sequences. *Lingua* **120**. 1821–1844.
- Halle, Morris (1995). Feature geometry and feature spreading. *Linguistic Inquiry* **16**. 1–46.
- Halle, Morris, Bert Vaux & Andrew Wolfe (2000). On feature spreading and the representation of place of articulation. *Linguistic Inquiry* **31**. 387–444.
- Halle, Morris & Jean-Roger Vergnaud (1980). Three dimensional phonology. *Journal of Linguistic Research* **1**. 83–105.
- Halle, Morris & Jean-Roger Vergnaud (1981). Harmony processes. In Wolfgang Klein & Williem Levelt (eds.) *Crossing the boundaries in linguistics: Studies presented to Manfred Bierwisch*, Dordrecht: Reidel. 1–22.
- Halle, Morris & Jean-Roger Vergnaud (1987). *An essay on stress*. Cambridge, MA: MIT Press.
- Hamann, Silke (2003). *The Phonetics and Phonology of Retroflexes*. Utrecht: LOT.
- Hammond, Michael (1988). On deriving the well-formedness condition. *Linguistic Inquiry* **19**. 319–325.
- Hamp, Eric P. (1958). Vowel harmony in Classical Mongolian. *Word* **14**. 291–294.

- Hamp, Eric P. (1980). Mongolian vocalic features and the problem of harmony. In Robert Vago (ed.) *Issues in vowel harmony*, Amsterdam: John Benjamins. 101–111.
- Hansson, Gunnar Ólafur (2001). *Theoretical and typological issues in consonant harmony*. Ph.D. dissertation, University of California, Berkley, Berkeley.
- Hansson, Gunnar Ólafur (2004). Tone and voicing agreement in Yabem. In Vineeta Chand, Ann Kelleher, Angelo J. Rodríguez & Benjamin Schmeister (eds.) *Proceedings of the 23<sup>rd</sup> West Coast Conference on Formal Linguistics*, Somerville, MA: Cascadilla Press. 318–331.
- Hansson, Gunnar Ólafur (2007a). Blocking effects in Agreement by Correspondence. *Linguistic Inquiry* **38**. 395–409.
- Hansson, Gunnar Ólafur (2007b). On the evolution of consonant harmony: the case of secondary articulation agreement. *Phonology* **24**. 77–120.
- Harms, Phillip Lee (1985). Epena Pedee (Saija) nasalization. In Ruth Brend (ed.) *From Phonology to Discourse: Studies in Six Columbian Languages*, Dallas, TX: Summer Institute of Linguistics. 13–18.
- Harms, Phillip Lee (1994). *Epena Pedee Syntax*. Arlington, TX: The Summer Institute of Linguistics and The University of Texas at Arlington.
- Harrington, M. (1974). Sibilants in Ventureño. *International Journal of American Linguistics* **40**. 1–9.
- Harris, John & Geoff Lindsey (1995). The elements of phonological representation. In Jacques Durand & Francis Katamba (eds.) *Frontiers of Phonology: Atoms, Structures, Derivations*, London, New York: Longman. 34–79.
- Hayes, Bruce (1980). *A metrical theory of stress rules*. Ph.D. dissertation, Massachusetts Institute of Technology, Cambridge.
- Hayes, Bruce (1984a). The phonetics and phonology of Russian voicing assimilation. In Mark Aronoff, Richard Oehrle, Frances Kelley & Bonnie Wilker Stephens (eds.) *Language Sound and Structure*, Cambridge, MA: MIT Press. 318–328.
- Hayes, Bruce (1984b). The phonology of rhythm in English. *Linguistic Inquiry* **15**. 33–74.
- Hayes, Bruce (1995). *Metrical Stress Theory: Principles and Case Studies*. Chicago: University of Chicago Press.

- Hayward, Richard J. (1982). Notes on the Koyra language. *Afrika und Übersee* **65**. 211–268.
- Hayward, Richard J. (1988). Remarks on the Omotic sibilants. In Marianne Bechhaus-Gerst & Serzisko Fritz (eds.) *Cushitic-Omotic: Papers from the International Symposium on Cushitic and Omotic Languages*, Hamburg: Helmut Buske Verlag. 263–299.
- Hayward, Richard J. (1990). Notes on the Aari language. In Richard Hayward (ed.) *Omotic language studies*, London: School of Oriental and African Studies, University of London. 425–493.
- Heegård, Jan & Ida Elisabeth Mørch (2004). Retroflex vowels and other paruliarities in the Kalasha sound system. In Anju Saxena (ed.) *Himalayan Languages: Past and Present*, Berlin: Mouton de Gruyter. 57–76.
- Herbert, Raymond J. & Nicholas N. Poppe (1963). *Kirghiz Manual*. The Hague: Indiana University, Bloomington.
- Hertzon, Robert & Habte Mariam Marcos (1966). Des traits pertinents superposés en ennemor. *Journal of Ethiopian Studies* **4**. 17–30.
- Hombert, Jean-Marie (1978). Consonant types, vowel quality and tone. In Victoria A. Fromkin (ed.) *Tone: A Linguistic Survey*, New York: Academic Press. 77–112.
- Hombert, Jean-Marie, John J. Ohala & William G. Ewan (1979). Phonetic explanations for the development of tones. *Language* **55**. 37–58.
- Hooper, Joan (1972). The syllable in phonological theory. *Language* **48**. 525–540.
- Hooper, Joan (1976). *An Introduction to Natural Generative Phonology*. New York: Academic Press.
- Howard, Irwin (1972). *A Directional Theory of Rule Application in Phonology*. Ph.D. dissertation, Massachusetts Institute of Technology, Cambridge.
- Hyde, Brett (2001). *Metrical and Prosodic Structure in Optimality Theory*. Ph.D. dissertation, Rutgers University, New Brunswick, NJ.
- Hyde, Brett (2002). A restrictive theory of metrical stress. *Phonology* **19**. 313–339.
- Hyde, Brett (2007). Issues in Banawá prosody: Onset sensitivity, minimal words, and syllable integrity. *Linguistic Inquiry* **38**. 239–285.

- Hyde, Brett (2008). Alignment continued: Distance-sensitivity, order-sensitivity, and the midpoint pathology. Ms. Available on Rutgers Optimality Archive, ROA 998, <http://roa.rutgers.edu>.
- Hyman, Larry (1995). Nasal consonant harmony at a distance: The case of Yaka. *Studies in African Linguistics* **24**. 5–30.
- Hyman, Larry (1998). Positional prominence and the ‘prosodic trough’ in Yaka. *Phonology* **15**. 41–75.
- Hyman, Larry (2002). ‘Abstract’ vowel harmony in Kàlòŋ: A system-driven account. In Patrick Sauzet & Anne Zribi-Hertz (eds.) *Typologie des langues d’Afrique et universaux de la grammaire, Vol. II*, Paris: L’Harmattan.
- Hyman, Larry (2002/to appear). Is there a right-to-left bias in vowel harmony? In John R. Rennison, Friedrich Neubarth & Markus A. Pochträger (eds.) *Phonologica 2002*, Berlin: Mouton de Gruyter.
- Hyman, Larry (2008). Directional asymmetries in the morphology and phonology of words, with special reference to Bantu. *Linguistics* **46**. 309–350.
- Hyman, Larry & Russell G. Schuh (1974). Universals of tone rules: evidence from West Africa. *Linguistic Inquiry* **5**. 81–115.
- Inkelas, Sharon (2000). Phonotactic blocking through structural immunity. In Barbara Stiebels & Dieter Wunderlich (eds.) *Lexicon in Focus*, Berlin: Akademie Verlag. 7–40.
- Inkelas, Sharon, Orhan Orgun & Cheryl Zoll (1996). Exceptions and static phonological patterns: cophonologies vs. prespecification. Ms., University of California Berkeley and MIT. Available on Rutgers Optimality Archive, ROA 124, <http://roa.rutgers.edu>.
- Inkelas, Sharon, Orhan C. Orgun & Cheryl Zoll (1997). The implications of lexical exceptions for the nature of grammar. In Iggy Roca (ed.) *Derivations and constraints in phonology*, Oxford: Clarendon Press. 393–418.
- Inkelas, Sharon & Draga Zec (1988). Serbo-Croatian pitch accent: the interaction of tone, stress, and intonation. *Language* **64**. 227–248.
- Inkelas, Sharon & Draga Zec (1995). Syntax-phonology interface. In John A. Goldsmith (ed.) *The Handbook of Phonological Theory*, Cambridge, MA: Blackwell. 535–549.

- Inkelas, Sharon & Cheryl Zoll (2005). *Reduplication: Doubling in Morphology*, vol. 106 of *Cambridge Studies in Linguistics*. Cambridge: Cambridge University Press.
- Inkelas, Sharon & Cheryl Zoll (2007). Is grammar dependence real? A comparison between cophological and indexed constraint approaches to morphologically conditioned phonology. *Linguistics* **45**. 133–172. Available on Rutgers Optimality Archive, ROA 587, <http://roa.rutgers.edu>.
- Itô, Junko (1984). Melodic dissimilation in Ainu. *Linguistic Inquiry* **15**. 505–513.
- Itô, Junko (1986/1988). *Syllable Theory in Prosodic Phonology*. New York: Garland.
- Itô, Junko & Armin Mester (1992). Weak layering and word binarity. Ms. Linguistic Research Center Working Paper LRC-92-09. University of California, Santa Cruz.
- Itô, Junko & Armin Mester (1995a). The core-periphery structure of the lexicon and constraints on reranking. In Jill Beckman, Suzanne Urbanczyk & Laura Walsh (eds.) *University of Massachusetts Occasional Papers in Linguistics 18*, Amherst: GLSA, University of Massachusetts. 181–209.
- Itô, Junko & Armin Mester (1995b). Japanese phonology. In John A. Goldsmith (ed.) *The Handbook of Phonological Theory*, Cambridge, MA and Oxford: Blackwell. 817–838.
- Itô, Junko & Armin Mester (1999). The phonological lexicon. In Natsuko Tsujimura (ed.) *The Handbook of Japanese Linguistics*, Oxford: Blackwell. 62–100.
- Itô, Junko & Armin Mester (2001). Covert generalizations in Optimality Theory: the role of stratal faithfulness constraints. *Studies in Phonetics, Phonology, and Morphology* **7**. 273–299.
- Itô, Junko & Armin Mester (2003). *Japanese Morphophonemics: Markedness and Word Structure*. Linguistic Inquiry Monographs, MIT Press.
- Itô, Junko & Armin Mester (2008a). Lexical classes in phonology. In Shigeru Miyagawa & Mamoru Saito (eds.) *The Handbook of Japanese Linguistics*, Oxford: Oxford University Press. 84–106.
- Itô, Junko & Armin Mester (2008b). Prosodic adjunction in Japanese compounds. In *MIT Working Papers in Linguistics 55: Proceedings of FAJL 4*, Cambridge, MA: MITWPL. 97–112.

- Itô, Junko & Armin Mester (2009). The extended prosodic word. In Janet Grijzenhout & Barış Kabak (eds.) *Phonological Domains: Universals and Deviations*, Berlin: Mouton de Gruyter. 105–194.
- Itô, Junko, Armin Mester & Jaye Padgett (1995). Licensing and underspecification in Optimality Theory. *Linguistic Inquiry* **26**. 571–631.
- Jacobs, Haike & Jeroen van de Weijer (1992). On the formal description of palatalisation. In Reineke Bok-Bennema & Roeland van Hout (eds.) *Linguistics in the Netherlands*, Amsterdam: John Benjamins. 125–135.
- Jakobson, Roman, Gunnar Fant & Morris Halle (1951). *Preliminaries to Speech Analysis*. Cambridge, MA: MIT Press.
- Jensen, John T. (1974). A constraint on variables in phonology. *Language* **50**. 675–686.
- Jensen, John T. (1978). Reply to “theoretical implications of Hungarian vowel harmony”. *Linguistic Inquiry* **9**. 89–97.
- Jensen, John T. (1984). A lexical phonology treatment of Hungarian vowel harmony. *Linguistic Analysis* **14**. 231–253.
- Jensen, John T. & Margaret Stong-Jensen (1979). The Relevancy Condition and variables in phonology. *Linguistic Analysis* **5**. 125–160.
- Johnson, Douglas C. (1972). *Formal aspects of phonological description*. The Hague and Paris: Mouton de Gruyter.
- Johnson, Douglas C. (1980). Regular disharmony in Kirgiz. In Robert Vago (ed.) *Issues in vowel harmony*, Amsterdam: John Benjamins. 89–99.
- Jurģec, Peter (2009). Autosegmental spreading is a binary relation. Paper presented at the 7th GLOW in Asia. Hyderabad, February 26.
- Jurģec, Peter (2010a). Disjunctive lexical stratification. *Linguistic Inquiry* **41**. 149–161.
- Jurģec, Peter (2010b). Icy targets. Paper presented at the 7th Old World Conference in Phonology. Nice, January 29.
- Jurģec, Peter (2010c). Long-distance derived environment effects. Ms. University of Tromsø.
- Ka, Omar (1988/1994). *Wolof Phonology and Morphology*. Lanham, MD: University Press of America.

- Kabak, Baris (2007). Hiatus resolution in Turkish: an underspecification account. *Lingua* **117**. 1378–1411.
- Kabak, Baris & Anthi Revithiadou (2009). An interface account to prosodic word recursion. In Janet Grijzenhout & Baris Kabak (eds.) *Phonological Domains: Universals and Deviations*, Berlin: Mouton de Gruyter. 105–132.
- Kahn, Daniel (1976). *Syllable-based generalizations in English phonology*. Ph.D. dissertation, Massachusetts Institute of Technology, Cambridge.
- Kaplan, Aaron (2008a). Licensing and noniterative harmony in Lango. In Emily J. Elfner & Martin Walkow (eds.) *Proceedings of NELS 37*, Amherst: GLSA, University of Massachusetts.
- Kaplan, Aaron (2008b). *Noniterativity is an Emergent Property of Grammar*. Ph.D. dissertation, University of California, Santa Cruz. Available on Rutgers Optimality Archive, ROA 977, <http://roa.rutgers.edu>.
- Kaplan, Abby (2010). *Phonology shaped by phonetics: The case of intervocalic lenition*. Ph.D. dissertation, University of California, Santa Cruz, Santa Cruz. Available on Rutgers Optimality Archive, ROA 1077, <http://roa.rutgers.edu>.
- Kardestuncer, Aino Berris (1982). *Theoretical implications of Turkish vowel harmony*. Ph.D. dissertation, University of Connecticut, Storrs.
- Karvonen, Daniel (2005). *Word prosody in Finnish*. Ph.D. dissertation, University of California, Santa Cruz, Santa Cruz, CA.
- Karvonen, Daniel & Adam Sherman (1997). Sympathy, opacity, and u-umlaut in Icelandic. *Phonology at Santa Cruz* **5**. 37–48.
- Karvonen, Daniel & Adam Sherman (1998). Opacity in Icelandic: A Sympathy account. In Tamanji Pius N. & Kiyomi Kusumoto (eds.) *Proceedings of NELS 28*, Amherst: GLSA, University of Massachusetts. 189–201.
- Kaun, Abigail R. (1995). *The Typology of Rounding Harmony: An Optimality Theoretic Approach*. Ph.D. dissertation, University of California, Los Angeles, Los Angeles. Available on Rutgers Optimality Archive, ROA 227, <http://roa.rutgers.edu>.
- Kaun, Abigail R. (2004). The typology of rounding harmony. In Bruce Hayes, Robert Kirchner & Donca Steriade (eds.) *Phonetically Based Phonology*, Cambridge: Cambridge University Press. 87–116.



- Kaye, Jonathan (1982). Harmony processes in Vata. In Harry van der Hulst & Norval Smith (eds.) *The Structure of Phonological Representations (Part II)*, Dordrecht: Foris. 385–452.
- Kaye, Jonathan, Jean Lowenstamm & Jean-Roger Vergnaud (1985). The internal structure of phonological elements: a theory of charm and government. *Phonology Yearbook* **2**. 305–328.
- Kaye, Jonathan, Jean Lowenstamm & Jean-Roger Vergnaud (1990). Constituent structure and government in phonology. *Phonology* **7**. 193–232.
- Kehrein, Wolfgang & Chris Golston (2004). A prosodic theory of laryngeal contrasts. *Phonology* **21**. 325–357.
- Kelly, John (1969). Urhobo. In Elizabeth Dunstan (ed.) *Twelve Nigerian languages*, New York: Africana Publishing Corporation. 153–161.
- Kenstowicz, Michael (1994). *Phonology in Generative Grammar*. Malden, MA: Blackwell.
- Kenstowicz, Michael (1997). Quality-sensitive stress. *Rivista di Linguistica* **9**. 157–187.
- Key, Michael (2007). Headed Spans and Bantu tonology. In Leah Bateman, Michael O’Keefe, Ehren Reilly & Adam Werle (eds.) *University of Massachusetts Occasional Papers in Linguistics 32: Papers in Optimality Theory III*, Amherst: GLSA, University of Massachusetts. 187–207. Available on Rutgers Optimality Archive, ROA 809, <http://roa.rutgers.edu>.
- Kiparsky, Paul (1971). Historical linguistics. In William Orr Dingwall (ed.) *A Survey of Linguistic Science*, College Park: University of Maryland. 576–649.
- Kiparsky, Paul (1973). Phonological representations. In Osamu Fujimura (ed.) *Three Dimensions of Linguistic Theory*, Tokyo: TEC. 1–136.
- Kiparsky, Paul (1979). Metrical structure assignment is cyclic. *Linguistic Inquiry* **10**. 421–441.
- Kiparsky, Paul (1981). Vowel harmony. Ms. Massachusetts Institute of Technology.
- Kiparsky, Paul (1984). On the lexical phonology of Icelandic. In C. Elert, I. Johansson & E. Strangert (eds.) *Nordic prosody*, Stockholm: Almqvist & Wiksell, vol. III. 135–164.

- Kiparsky, Paul (1985). Some consequences of Lexical Phonology. *Phonology* **2**. 85–138.
- Kiparsky, Paul (1993). Blocking in non-derived environments. In Sharon Hargus & Ellen M. Kaisse (eds.) *Phonetics and Phonology 4: Studies in Lexical Phonology*, San Diego, CA: Academic Press. 277–313.
- Kirchner, Robert (1993). Turkish vowel harmony and disharmony: An Optimality Theoretic account. Ms. University of Alberta. Available on Rutgers Optimality Archive, ROA 4, <http://roa.rutgers.edu>.
- Kirchner, Robert (2001). *An effort based approach to consonant lenition*. New York: Routledge.
- Kisseberth, Charles (1969). *Theoretical implications of Yawelmani phonology*. Ph.D. dissertation, University of Illinois, Urbana, IL.
- Kisseberth, Charles (1994). On domains. In Jennifer Cole & Charles Kisseberth (eds.) *Perspectives in Phonology*, Stanford, CA: CSLI Publications. 133–166.
- Kisseberth, Charles & David Odden (2003). Tone. In Derek Nurse & Gérard Philippson (eds.) *The Bantu Languages*, London: Routledge, chap. 5. 59–70.
- Klein, Thomas B. (1995/2000). *Umlaut in Optimality Theory: A Comparative Analysis of German and Chamorro*. Tübingen: Niemeyer.
- Kochetov, Alexei & Milica Radišić (2009). Latent consonant harmony in Russian. In Maria Babyonyshev, Daria Kavitskaya & Jodi Reich (eds.) *Formal Approaches to Slavic Linguistics 17: The Yale Meeting 2008*, Ann Arbor, MI: Michigan Slavic Publications. 111–130.
- Kontra, Miklós & Catherine Ringen (1987). Stress and harmony in Hungarian loanwords. In Károly Rédei (ed.) *Studien zur Phonologie und Morphologie der uralischen Sprachen*, Vienna: Verband der wissenschaftlichen Gesellschaften Österreichs. 81–96.
- Korkina, E. I., E. I. Ubrjatova, G. N. Haritonov & N. E. Petrov (eds.) (1982). *Grammatika sovremennogo jakutskogo literaturnogo jazyka: fonetika i morfologija*. Moskva: Izdatel'stvo Nauka.
- Korn, David (1969). Types of labial vowel harmony in the Turkic languages. *Anthropological Linguistics* **11**. 98–106.
- Kornfilt, Jaklin (1997). *Turkish*. London: Routledge.

- Kowalski, Tadeusz (1929). *Karaimische texte im dialekt von Troki*. Cracow: Nakładem Polskiej Akademji Umiejętności.
- Krämer, Martin (2001). Yucatec Maya vowel alternations – harmony as syntagmatic identity. *Zeitschrift für Sprachwissenschaft* **20**. 175–217.
- Krämer, Martin (2002). Local constraint conjunction and neutral vowels in Finnish harmony. In Brunger Karen (ed.) *Belfast Working Papers in Language and Linguistics, vol. 15*, Belfast: University of Ulster. 38–64.
- Krämer, Martin (2003). *Vowel Harmony and Correspondence Theory*. Berlin and New York: Mouton de Gruyter.
- Krueger, John R. (1962). *Yakut Manual*. The Hague: Indiana University, Bloomington.
- Krueger, John R. (1977). *Tuvan Manual*. The Hague: Indiana University, Bloomington.
- Kuroda, S.-Y. (1967). *Yawelmani Phonology*. Cambridge, MA: MIT Press.
- Ladd, Robert & William N. Campbell (1991). Theories of prosodic structure: Evidence from syllable duration. In *Proceedings of the XIIth International Congress of Phonetic Sciences 2*, Aix-en-Provence. 290–293.
- Lahiri, Aditi & Vincent Evers (1991). Palatalization and coronality. In Carole Paradis & Jean-François Prunet (eds.) *Phonetics and Phonology 2: Volume 2. The Special status of Coronals, Internal and External Evidence*, San Diego, CA: Academic Press. 79–100.
- Lahrouchi, Mohamed (2010). On the internal structure of Tashlhiyt Berber tri-consonantal roots. *Linguistic Inquiry* **41**. 255–285.
- Langendoen, Terrence D. (1968). *The London School of Linguistics*. Cambridge, MA: MIT Press.
- Leben, William (1973). *Suprasegmental Phonology*. New York: Garland.
- Leben, William (1982). Metrical of autosegmental. In Harry van der Hulst & Norval Smith (eds.) *The Structure of Phonological Representations (Part I)*, Dordrecht: Foris. 177–190.
- Lee, Seunghun Julio (2008). *Consonant-tone interaction in Optimality Theory*. Ph.D. dissertation, Rutgers University, New Brunswick, NJ. Available on Rutgers Optimality Archive, ROA 1027, <http://roa.rutgers.edu>.

- Lehiste, Ilse (1972). The timing of utterances and linguistic boundaries. *The Journal of the Acoustical Society of America* **51**. 2018–2024.
- Levergood, Barbara (1984). Rule-governed vowel harmony and the Strict Cycle. In *Proceedings of NELS 14*, Amherst, MA: GLSA. 275–93.
- Lewis, G. L. (1967). *Turkish Grammar*. Oxford: Oxford University Press.
- Li, Bing (1996). *Tungusic Vowel Harmony: Description and analysis*. The Hague: Holland Academic Graphics.
- Liberman, Mark & Alan Prince (1977). On stress and linguistic rhythm. *Linguistic Inquiry* **8**. 249–336.
- Lieber, Rochelle (1987). *An Integrated Theory of Autosegmental Processes*. Albany, NY: State University of New York Press.
- Lindblom, Björn (1963). Spectrographic study of vowel reduction. *The Journal of the Acoustical society of America* **35**. 1773–1781.
- Local, John & Ken Lodge (1996). Another travesty of representation: Phonological representation and phonetic interpretation and phonetic interpretation of ATR harmony in Kalenjin. *York Papers in Linguistics* **17**. 77–117.
- Lodge, Ken (1995). Kalenjin phonology and morphology: A further exemplification of underspecification and non-destructive phonology. *Lingua* **96**. 29–43.
- Lombardi, Linda (1995a). Dahl's Law and privative [voice]. *Linguistic Inquiry* **26**. 365–372.
- Lombardi, Linda (1995b). Laryngeal features and privativity. *The Linguistic Review* **12**. 35–59.
- Lombardi, Linda (1998). Evidence for Max Feature constraints from Japanese. In Haruka Fukazawa, Frida Morelli, Caro Struijke & Yi-Ching Su (eds.) *University of Maryland Working Papers in Linguistics 7*, University of Maryland. 41–62. Available on Rutgers Optimality Archive, ROA 247, <http://roa.rutgers.edu>.
- Lombardi, Linda (1999). Positional Faithfulness and voicing assimilation in Optimality Theory. *Natural Language and Linguistic Theory* **17**. 267–302.
- Loos, Eugene Emil (1969). *The phonology of Capanahua and its grammatical basis*. Summer Institute of Linguistics of the University of Oklahoma.

- Lubowicz, Anna (2002a). *Contrast Preservation in Phonological Mappings*. Ph.D. dissertation, University of Massachusetts Amherst, Amherst. Available on Rutgers Optimality Archive, ROA 554, <http://roa.rutgers.edu>.
- Lubowicz, Anna (2002b). Derived environment effects in Optimality Theory. *Lingua* **112**. 243–280.
- Lubowicz, Anna (2005). Locality of conjunction. In John Alderete, Chung-hye Han & Alexei Kochetov (eds.) *Proceedings of the 24<sup>th</sup> West Coast Conference on Formal Linguistics*, Somerville, MA: Cascadilla Press. 254–262.
- Mackenzie, Sara (2009). *Contrast and Similarity in Consonant Harmony Processes*. Ph.D. dissertation, University of Toronto, Toronto.
- Magen, Harriet S. (1997). The extent of vowel-to-vowel coarticulation in English. *Journal of Phonetics* **25**. 187–205.
- Mahanta, Shakuntala (2007). *Directionality and locality in vowel harmony: with special reference to vowel harmony in Assamese*. Utrecht: LOT.
- Maiden, Martin (1991). *Interactive Morphology: Metaphony in Italian*. New York: Routledge.
- Markó, Alexandra, Tekla Etelka Gráczki & Judit Bóna (2010). The realisation of voicing assimilation rules in Hungarian spontaneous and read speech: case studies. *Acta Linguistica Hungarica* **57**. 210–238.
- Mascaró, Joan (1978). *Catalan phonology and the phonological cycle*. Bloomington, IN: Indiana University Linguistics Club.
- Mascaró, Joan (2003). Comparative markedness and derived environments. *Theoretical Linguistics* **29**. 113–122.
- Mascaró, Joan (to appear). La distribució de les vocals mitjanes tò niques en català central. *Caplletra* **46**.
- McCarthy, John J. (1979). *Formal problems in Semitic phonology and morphology*. Ph.D. dissertation, Massachusetts Institute of Technology, Cambridge.
- McCarthy, John J. (1982). Prosodic structure and expletive infixation. *Language* **58**. 574–590.
- McCarthy, John J. (1986). OCP effects: gemination and antigemination. *Linguistic Inquiry* **17**. 207–264.

- McCarthy, John J. (1988). Feature geometry and dependency. *Phonetica* **43**. 84–108.
- McCarthy, John J. (1997). Process specific constraints in Optimality Theory. *Linguistic Inquiry* **28**. 231–251.
- McCarthy, John J. (1999). Sympathy and phonological opacity. *Phonology* **16**. 331–399.
- McCarthy, John J. (2003a). OT constraints are categorical. *Phonology* **20**. 75–138.
- McCarthy, John J. (2003b). What does comparative markedness explain, what should it explain, and how? *Theoretical Linguistics* **29**. 141–155.
- McCarthy, John J. (2004). Headed spans and autosegmental spreading. Ms., University of Massachusetts Amherst. Available on Rutgers Optimality Archive, ROA 685, <http://roa.rutgers.edu>.
- McCarthy, John J. (2007a). Consonant harmony via correspondence: Evidence from Chumash. In Leah Bateman, Michael O’Keefe, Ehren Reilly & Adam Werle (eds.) *University of Massachusetts Occasional Papers in Linguistics 32: Papers in Optimality Theory III*, Amherst: GLSA, University of Massachusetts. 223–238. Available on Rutgers Optimality Archive, ROA 879, <http://roa.rutgers.edu>.
- McCarthy, John J. (2007b). *Hidden Generalizations: Phonological Opacity in Optimality Theory*. London: Equinox Publishing Company.
- McCarthy, John J. (2009). Harmony in Harmonic Serialism. Ms., University of Massachusetts, Amherst. Available on Rutgers Optimality Archive, ROA 1009, <http://roa.rutgers.edu>.
- McCarthy, John J. & Alan Prince (1986). Prosodic Morphology 1986. Ms.
- McCarthy, John J. & Alan Prince (1993a). Generalized Alignment. In Geert Booij & Jaap van Marle (eds.) *Yearbook in Morphology 1993*, Dordrecht: Kluwer. 79–153.
- McCarthy, John J. & Alan Prince (1993b). Prosodic Morphology I. Ms., University of Massachusetts and Rutgers University, Amherst, and New Brunswick, NJ. Available on Rutgers Optimality Archive, ROA 482, <http://roa.rutgers.edu>.
- McCarthy, John J. & Alan Prince (1995). Faithfulness and reduplicative identity. In Jill N. Beckman, Laura Walsh & Suzanne Urbanczyk (eds.) *University of Massachusetts Occasional Papers in Linguistics 18: Papers in Optimality Theory*, Amherst: GLSA, University of Massachusetts. 249–384. Available on Rutgers Optimality Archive, ROA 60, <http://roa.rutgers.edu>.

- McCarthy, John J. & Alan Prince (1999). Faithfulness and identity in prosodic morphology. In René Kager & Harry van der Hulst (eds.) *The Prosody–Morphology Interface*, Cambridge: Cambridge University Press. 218–309.
- McCawley, James D. (1968). *The phonological component of a grammar of Japanese*. Monographs on Linguistic Analysis, The Hague and Paris: Mouton de Gruyter.
- Michel, Dan (to appear). Positional transparency in c’Lela. In *Chicago Linguistic Society (CLS) 45*, Chicago: Chicago Linguistic Society.
- Milligan, Marianne (2000). A new look at Menominee vowel harmony. In John D. Nichols (ed.) *Papers of the 31st Annual Algonquian Conference*, Winnipeg: University of Manitoba. 237–254.
- Mmusi, Sheila Onkaetse (1992). *Obligatory Contour Principle effects and violations: the case of Setswana verbal tone (Botswana, South Africa)*. Ph.D. dissertation, University of Illinois, Urbana-Champaign.
- Modarresi, Golnaz, Harvey Sussman, Björn Lindblom & Elizabeth Burlingame (2004). An acoustic analysis of the bidirectionality of coarticulation in VCV utterances. *Journal of Phonetics* **32**. 291–312.
- Moon, Seung-Jae & Björn Lindblom (1994). Interaction between duration, context, and speaking style in English stressed vowels. *The Journal of the Acoustical society of America* **96**. 40–55.
- Mørch, Ida Elisabeth & Jan Heegård (1997). *Retroflekse vokalers oprindelse i kalashamon i historisk og areal lingvistisk perspektiv og Variation i sprogbeskrivelsen: vokallængde i kalashamon: En analyse af to emner i kalashamon-fonologien*. Master’s thesis, University of Copenhagen, Copenhagen.
- Morén, Bruce (1999/2001). *Distinctiveness, Coercion and Sonority: A Unified Theory of Weight*. New York, London: Routledge. Available on Rutgers Optimality Archive, ROA 349, <http://roa.rutgers.edu>.
- Morén, Bruce (2000). The puzzle of Kashmiri stress: implications for weight theory. *Phonology* **17**. 365–396.
- Morén, Bruce (2003). The parallel structures model of feature geometry. In J. Brugman & A. Rhiel (eds.) *Working Papers of the Cornell Phonetics Laboratory*, Cornell University, vol. 15. 194–270.

- Morén, Bruce (2006a). “ATR” harmony in Kàlòng and Nez Perce without [ $\pm$ ATR]: Abstraction, economy and primitives. Paper presented at the 3rd Old World Conference in Phonology, Budapest, Hungary.
- Morén, Bruce (2006b). Consonant-vowel interactions in Serbian: Features, representations and constraint interactions. *Lingua* **116**. 1198–1244.
- Morén, Bruce (2006c). How far can we go toward substance-free phonological features and why? Paper presented at the Phonological Bases of Phonological Features Workshop (Tromsø, September 28–29).
- Morén, Bruce (2006d). Looking beyond harmony: a more complete picture of Hungarian vowels. Paper presented at the 14th Manchester Phonology Meeting. Manchester, May 26.
- Morén, Bruce (2007a). Building universal prosodic structure without innate prosodic structure. Ms. University of Tromsø.
- Morén, Bruce (2007b). The division of labor between segment-internal structure and violable constraints. In Sylvia Blaho, Patrik Bye & Martin Krämer (eds.) *Freedom of Analysis?*, Berlin: Mouton de Gruyter. 215–235.
- Morén, Bruce (2007c). Minimalist/substance-free feature theory: Case studies and implications. Ms./Handout at the Eastern European Generative Grammar Summer School (Brno, August 6–10).
- Morén, Bruce (2007d). Minimalist/substance-free feature theory: Why and how. Ms./Handout at the Eastern European Generative Grammar Summer School (Brno, July 30–August 3).
- Morén, Bruce (2008). Using the prosodic hierarchy to account for North Germanic tones. Paper presented at the Workshop on the Prosodic Hierarchy (Tromsø, September 5).
- Morén-Duolljá, Bruce (2010). Saami languages – why data sharing in Scandinavia is vital. Paper presented at the 6th Grand Meeting for Scandinavian Dialect Syntax, Sommarøya, Tromsø, June 7.
- Morgenstierne, Georg (1973). *Indo-Iranian frontier languages: Volume 4: The Kalasha Language*. Oslo: Universitetsforlaget.
- Murry, Thomas & Sadanand Singh (1980). Multidimensional analysis of male and female voices. *The Journal of the Acoustical society of America* **68**. 1294–1300.



- Myers, Scott (1987). *Tone and the structure of words in Shona*. Ph.D. dissertation, University of Massachusetts Amherst, Amherst.
- Myers, Scott (1997). OCP effects in Optimality Theory. *Natural Language and Linguistic Theory* **15**. 847–892.
- Myers, Scott (1999). Tone association and F<sub>0</sub> timing in Chichewa. *Studies in African Linguistics* **28**. 215–239.
- Myers, Scott (2003). F<sub>0</sub> timing in Kinyarwanda. *Phonetica* **60**. 71–97.
- Nespor, Marina & Irene Vogel (1986). *Prosodic Phonology*. Dordrecht: Foris.
- Nevins, Andrew (2010). *Locality in Vowel Harmony*. Cambridge, MA: MIT Press.
- Nevins, Andrew & Bert Vaux (2004). Consonant harmony in Karaim. In Anikó Csirmaz, Youngjoo Lee & MaryAnn Walker (eds.) *MIT Working Papers in Linguistics 46: The Proceedings of the Workshop on Altaic in Formal Linguistics*, Cambridge, MA: MITWPL. 175–194.
- Newman, Stanley S. (1944). *The Yokuts Language of California*. New York: The Viking Fund Publications in Anthropology.
- Ní Chiosáin, Máire (1994). Irish palatalisation and the representation of place features. *Phonology* **11**. 89–106.
- Ní Chiosáin, Máire & Jaye Padgett (1997). Markedness, segment realization, and locality of spreading. In *Report no. LRC-97-01, Linguistics Research Center*, Santa Cruz: University of California, Santa Cruz. Available on Rutgers Optimality Archive, ROA 188, <http://roa.rutgers.edu>.
- Ní Chiosáin, Máire & Jaye Padgett (2001). Markedness, segment realization, and locality of spreading. In Linda Lombardi (ed.) *Segmental Phonology in Optimality Theory: Constraints and Representations*, Santa Cruz: Cambridge University Press. 118–156.
- Nitta, Tetsuo (2001). The accent system in the Kanazawa dialect: The relationship between pitch and sound segments. In Shigeki Kaji (ed.) *Proceedings of the Symposium Cross-Linguistic Studies of Tonal Phenomena: Tonogenesis, Japanese Accentology, and Other Topics*, Tokyo: Tokyo University of Foreign Studies. 153–185.
- Noonan, Michael (1992). *A Grammar of Lango*. Berlin: Mouton de Gruyter.

- Noske, Manuela (1990). Vowel harmony in Turkana. *Studies in the Linguistic Sciences* **20**. 123–134.
- Noske, Manuela (1996). [ATR] harmony in Turkana. *Studies in African Linguistics* **25**. 61–99.
- Noske, Manuela (2000). [ATR] harmony in Turkana: A case of Faith suffix  $\gg$  Faith root. *Natural Language and Linguistic Theory* **18**. 771–812.
- Noske, Roland (1985). Syllabification and syllable changing processes in Yawelmani. In Harry van der Hulst & Norval Smith (eds.) *Advances in Nonlinear Phonology*, Dordrecht: Foris. 335–361.
- Noske, Roland (1993). *A Theory of Syllabification and Segmental Alternation: With studies on the phonology of French, German, Tonkawa and Yawelmani*. Tübingen: Niemeyer.
- Odden, David (1977). Overspecification and variables in phonology. *Linguistic Analysis* **3**. 177–196.
- Odden, David (1980). The Relevancy Condition. *Linguistic Analysis* **6**. 261–304.
- Odden, David (1981). *Problems of Tone Assignment in Shona*. Ph.D. dissertation, University of Illinois, Urbana-Champaign.
- Odden, David (1988). Anti antigemination and the OCP. *Linguistic Inquiry* **19**. 451–476.
- Odden, David (1991). Vowel geometry. *Phonology* **8**. 261–289.
- Odden, David (1994). Adjacency paramaters in phonology. *Language* **70**. 289–330.
- Odden, David (2001). Comments on “the accent system in the Kanazawa dialect: The relationship between pitch and sound segments”. In Shigeki Kaji (ed.) *Proceedings of the Symposium Cross-Linguistic Studies of Tonal Phenomena: Tonogenesis, Japanese Accentology, and Other Topics*, Tokyo University of Foreign Studies. 187–193.
- Ohala, John J. (1981). The listener as a source of sound change. In Carrie S. Masek, Roberta A. Hendrick & Mary Frances Miller (eds.) *Papers from the Parasession on Language and Behavior*, Chicago: Chicago Linguistic Society. 178–203.
- Ohala, John J. (1994a). Hierarchies of environments for sound variation; plus implications for “neutral” vowels in vowel harmony. *Acta Linguistica Hafniensia* **27**. 371–382.

- Ohala, John J. (1994b). Towards a universal, phonetically-based, theory of vowel harmony. In *Proceedings of the 3rd International Conference on Spoken Languages Processing*, Yokohama. 491–494.
- Öhman, S. E. G. (1966). Coarticulation in VCV utterances: Spectrographic measurements. *Journal of the Acoustical Society of America* **39**. 151–168.
- Okello, Jenny (1975). *Some phonological and morphological processes in Lango*. Ph.D. dissertation, Indiana University, Bloomington.
- Oller, D. Kimbrough (1973). The effect of position in utterance on speech segment duration in English. *Journal of the Acoustical Society of America* **54**. 1235–1247.
- Olsson, Magnus (1992). *Hungarian Phonology and Morphology*. Lund: Lund University.
- Onn, Farid M. (1980). *Aspects of Malay Phonology and Morphology: A Generative Approach*. Ph.D. dissertation, Universiti Kebangsaan Malaysia, Bangi.
- Orešnik, Janez (1975). The modern Icelandic u-umlaut rule. In Karl-Hampus Dahlstedt (ed.) *The Nordic Languages and Modern Linguistics 2: Proceedings of the Second International Conference of Nordic and General Linguistics, 2*, Stockholm: Almqvist & Wiksell. 621–633.
- Orešnik, Janez (1977). Modern Icelandic U-Umlaut from the descriptive point of view. *Gripla* **2**. 151–182.
- Orgun, Orhan & Ronald Sprouse (2007). A freer input: Yowlumne opacity and the Enriched Input Model. In Sylvia Blaho, Patrik Bye & Martin Krämer (eds.) *Freedom of Analysis?*, Berlin: Mouton de Gruyter. 93–121.
- Padgett, Jaye (1991). *Stricture in Feature Geometry*. Ph.D. dissertation, University of Massachusetts, Amherst.
- Padgett, Jaye (1991/1995). *Stricture in Feature Geometry*. Stanford, CA: CSLI Publications.
- Padgett, Jaye (1995). Partial class behavior and nasal place assimilation. In Kei-ichiro Suzuki & Dirk Elzinga (eds.) *Proceedings of the Southwestern Workshop in Optimality Theory*, Tucson, AZ: The University of Coyoute Papers. 145–183.
- Padgett, Jaye (2002a). Feature classes in phonology. *Language* **78**. 81–110.
- Padgett, Jaye (2002b). Russian voicing assimilation, final devoicing, and the problem of [v]. Ms. University of California Santa Cruz. Available on Rutgers Optimality Archive, ROA 528, <http://roa.rutgers.edu>.

- Painter, Colin (1973). Cineradiographic data on the feature ‘covered’ in Twi vowel harmony. *Phonetica* **28**. 97–120.
- Paradis, Carole (1992). *Lexical Phonology and Morphology: The Nominal Classes in Fula*. New York: Garland.
- Paster, Mary (2004). Vowel height harmony and blocking in Buchan Scots. *Phonology* **21**. 359–407.
- Pater, Joe (1999). Austronesian nasal substitution and other NC effects. In René Kager, Harry van der Hulst & Wim Zonneveld (eds.) *The Prosody Morphology Interface*, Cambridge, MA: Cambridge University Press. 310–343. Available on Rutgers Optimality Archive, ROA 160, <http://roa.rutgers.edu>.
- Pater, Joe (2000). Non-uniformity in English secondary stress: the role of ranked and lexically specific constraints. *Phonology* **17**. 237–274.
- Pater, Joe (2007). The locus of exceptionality: Morpheme-specific phonology as constraint indexation. In Leah Bateman, Michael O’Keefe, Ehren Reilly & Adam Werle (eds.) *University of Massachusetts Occasional Papers in Linguistics 32: Papers in Optimality Theory III*, Amherst: GLSA, University of Massachusetts. 259–296. Available on Rutgers Optimality Archive, ROA 866, <http://roa.rutgers.edu>.
- Pater, Joe (2009). Morpheme-specific phonology: Constraint indexation and inconsistency resolution. In Steve Parker (ed.) *Phonological Argumentation: Essays on Evidence and Motivation*, London: Equinox. 123–154. Available on Rutgers Optimality Archive, ROA 906, <http://roa.rutgers.edu>.
- Pearce, Mary (2006). Evidence against voicing spread in Kera. In Richard Breheny & Mary Pearce (eds.) *UCL Working Papers in Linguistics*, London: University College London, Department of Phonetics and Linguistics, vol. 18. 345–355.
- Pearce, Mary (2007). *The interaction of tone with voicing and foot structure: evidence from Kera phonetics and phonology*. Ph.D. dissertation, University of London, London.
- Pearce, Mary (2009). Kera tone and voicing interactions. *Lingua* **119**. 846–864.
- Peperkamp, Sharon (1997). *Prosodic Words*. The Hague: Holland Academic Graphics.
- Petrova, Olga, Rosemary Plapp, Catherine Ringen & Szilárd Szentgyörgyi (2006). Voice and assimilation: Evidence from Russian, Hungarian, German, Swedish, and Turkish. *The Linguistic Review* **23**. 1–35.

- Petrova, Olga & Szilárd Szentgyörgyi (2004). /v/ and voice assimilation in Hungarian and Russian. *Folia Linguistica* **38**. 87–116.
- Phelps, Elaine (1978). Exceptions and vowel harmony in Hungarian. *Linguistic Inquiry* **9**. 98–105.
- Pierrehumbert, Janet M. (1993). Dissimilarity in the Arabic verbal roots. In *Proceedings of NELS 23*, GLSA. 367–381.
- Piggott, Glyne (1987). On the autonomy of the feature Nasal. In Anna Bosch, Barbara Need & Eric Shiller (eds.) *Chicago Linguistic Society (CLS) 23-2: Parasession on Autosegmental and Metrical Phonology*, Chicago: Chicago Linguistic Society. 223–238.
- Piggott, Glyne (1992). Variability in feature dependency: The case of nasality. *Natural Language and Linguistic Theory* **10**. 33–77.
- Piggott, Glyne (2000). Against featural alignment. *Journal of Linguistics* **36**. 85–129.
- Piggott, Glyne (2003). Theoretical implications of segment neutrality in nasal harmony. *Phonology* **20**. 375–424.
- Piggott, Glyne & Harry van der Hulst (1997). Locality and the nature of nasal harmony. *Lingua* **103**. 85–112.
- Piternann, Michel (2000). Effect of speaking rate and contrastive stress on formant dynamics and vowel perception. *The Journal of the Acoustical society of America* **107**. 3425–3437.
- Polgárdi, Krisztina (1998/2006). *Vowel Harmony: An Account in Terms of Government and Optimality*. Leiden: LOT.
- Polgárdi, Krisztina (1999). Vowel harmony and disharmony in Turkish. *The Linguistic Review* **16**. 187–204.
- Poppe, Nicholas N. (1951). *Khalkha-Mongolische Grammatik*. Wiesbaden: Otto Harrassowitz.
- Poppe, Nicholas N. (1959). Das Yakutische. In Jean Deny (ed.) *Philologiae Turcicae Fundamenta*, Wiesbaden: Steiner, vol. 1. 671–684.
- Poppe, Nicholas N. (1960). *Buriat Grammar*. Bloomington: Indiana University.
- Poppe, Nicholas N. (1962). *Bashkir Manual*. The Hague: Indiana University, Bloomington.

- Poser, William J. (1982). Phonological representation and action-at-a-distance. In Harry van der Hulst & Norval Smith (eds.) *The Structure of Phonological Representations (Part II)*, Dordrecht: Foris. 121–158.
- Poser, William J. (1993). Are strict cycle effects derivable? In Sharon Hargus & Ellen M. Kaisse (eds.) *Studies in Lexical Phonology*, New York: Academic Press. 315–321.
- Poser, William J. (2004). On the status of Chumash sibilant harmony. Ms., University of Pennsylvania, Philadelphia.
- Potts, Christopher, Joe Pater, Karen Jesney, Rajesh Bhatt & Michael Becker (2010). Harmonic Grammar with linear programming: from linear systems to linguistic typology. *Phonology* **27**. 77–117.
- Prince, Alan (1983). Relating to grid. *Linguistic Inquiry* **14**. 19–100.
- Prince, Alan (2000/2002). Arguing optimality. In Andries Coetzee, Angela Carpenter & Paul de Lacy (eds.) *Papers in Optimality Theory II*, Amherst: GLSA, University of Massachusetts. 1–33. Available on Rutgers Optimality Archive, ROA 562, <http://roa.rutgers.edu>.
- Prince, Alan & Paul Smolensky (1993/2004). *Optimality Theory: Constraint Interaction in Generative Grammar*. Malden, MA: Blackwell. Available on Rutgers Optimality Archive, ROA 537, <http://roa.rutgers.edu>.
- Pulleyblank, Douglas (1989). Patterns of feature cooccurrence: The case of nasality. In S. Lee Fulmer, Masahide Ishihara & Wendy Wiswall (eds.) *Proceedings of the Arizona Phonology Conference*, Tucson, AZ: Coyote Working Papers, University of Arizona, vol. 9. 98–115.
- Pulleyblank, Douglas (1996). Neutral vowels in Optimality Theory: A comparison of Yoruba and Wolof. *Canadian Journal of Linguistics* **41**. 295–347.
- Pulleyblank, Douglas (2002). Harmony drivers: No disagreement allowed. In *Proceedings of the 28th Annual meeting of the Berkeley Linguistics Society*. 249–267.
- Recasens, Daniel (1987). An acoustic analysis of V-to-C and V-to-V coarticulatory effects in Catalan and Spanish VCV sequence. *Journal of Phonetics* **15**. 299–312.
- Ribeiro, Eduardo Rivail (2002). Directionality in vowel harmony: The case of Karajá (Macro-Jê). In *Proceedings of BLS 28*, Berkeley, CA: Berkeley Linguistics Society. 475–785. Ms.

- Rice, Curt (2011). Ternary rhythm. In Marc van Oostendorp, Colin J. Ewen, Elizabeth Hume & Keren D. Rice (eds.) *The Blackwell Companion to Phonology*, Malden, MA: Blackwell, vol. 5. 1228–1244.
- Rice, Keren D. (1992). On deriving sonority: A structural account of sonority relationships. *Phonology* **9**. 61–99.
- Rice, Keren D. (1993). A reexamination of the feature [sonorant]: The status of ‘sonorant obstruents’. *Language* **69**. 308–344.
- Richter, Gregory Charles (1982). *A Generative Phonology of Modern Icelandic*. Ph.D. dissertation, University of California, San Diego, San Diego.
- Ringen, Catherine (1975/1988). *Vowel harmony: Theoretical Implications*. New York: Garland.
- Ringen, Catherine (1980). A concrete analysis of Hungarian vowel harmony. In Robert Vago (ed.) *Issues in vowel harmony*, Amsterdam: John Benjamins. 135–154.
- Ringen, Catherine (1982). Abstractness and the theory of exceptions. *Linguistic Analysis* **10**. 191–202.
- Ringen, Catherine (1988a). Transparency in Hungarian vowel harmony. *Phonology* **5**. 327–342.
- Ringen, Catherine (1988b). Underspecification theory and binary features. In Harry van der Hulst & Norval Smith (eds.) *Features, Segmental Structure and Harmony Processes (Part II)*, Dordrecht: Foris. 145–160.
- Ringen, Catherine & Orvokki Heinämäki (1999). Variation in Finnish vowel harmony: An OT account. *Natural Language and Linguistic Theory* **17**. 303–337.
- Ringen, Catherine & Miklós Kontra (1989). Hungarian neutral vowels. *Lingua* **78**. 181–191.
- Ringen, Catherine & Robert Vago (1998). Hungarian vowel harmony in Optimality Theory. *Phonology* **15**. 393–416.
- Robins, R. H. (1957). Vowel nasality in Sundanese, a phonological and grammatical study. In *Studies in linguistic analysis*, Oxford: Blackwell. 87–103.
- Rose, Sharon (2004). Long-distance vowel-consonant agreement in Harari. *Journal of African Languages and Linguistics* **25**. 41–87.

- Rose, Sharon & Rachel Walker (2004). A typology of consonant agreement as correspondence. *Language* **80**. 475–531.
- Rubach, Jerzy (2007). Feature geometry from the perspective of Polish, Russian, and Ukrainian. *Linguistic Inquiry* **38**. 85–138.
- Rubach, Jerzy (2008). Prevocalic faithfulness. *Phonology* **25**. 433–468.
- Saeed, John (1999). *Somali*. Amsterdam: John Benjamins.
- Saeed, John Ibrahim (1993). *Somali Reference Grammar*. Kensington, MD: Dunwoody Press.
- Safir, Ken (1982). Nasal spreading in Capanahua. *Linguistic Inquiry* **13**. 689–694.
- Sagey, Elizabeth (1988). On the ill-formedness of crossing association lines. *Linguistic Inquiry* **19**. 109–118.
- Sagey, Elizabeth (1990). *The Representation of Features in Non-Linear Phonology: The Articulator Node Hierarchy*. New York and London: Garland.
- Sakel, Jeanette (2004). *A Grammar of Mosetén*. Berlin and New York: Walter de Gruyter.
- Samek-Ludovici, Vieri & Alan Prince (1999). Optima. Rutgers Center for Cognitive Science, RuCCS-TR-57. Available on Rutgers Optimality Archive, ROA 363, <http://roa.rutgers.edu>.
- Samek-Ludovici, Vieri & Alan Prince (2002). Fundamental properties of harmonic bounding. Rutgers Center for Cognitive Science, RuCCS-TR-71. Available on Rutgers Optimality Archive, ROA 785, <http://roa.rutgers.edu>.
- Samuels, Bridget (2009). *The Structure of Phonological Theory*. Ph.D. dissertation, Harvard University, Cambridge, MA. Available on Lingbuzz, 863, <http://ling.auf.net>.
- Sapir, Edward (1921). *Language: An Introduction to the Study of Speech*. New York: Harcourt, Brace & Co.
- Sapir, J. David (1965). *A Grammar of Diola-Fogny: A language spoken in the Basse-Casamance region of Senegal*. Cambridge: Cambridge University Press.
- Schein, Barry & Donca Steriade (1986). On geminates. *Linguistic Inquiry* **17**. 691–744.



- Schourup, Lawrence (1973). A cross-linguistic study of vowel nasalization. In *Working Papers in Linguistics*, Columbus, OH: Ohio State University, vol. 15. 190–221.
- Schuh, Russell G. (1978). Tone rules. In Victoria A. Fromkin (ed.) *Tone: A Linguistic Survey*, New York: Academic Press. 221–256.
- Sebeok, Thomas A. & Frances J. Ingemann (1961). *An Eastern Cheremis Manual: Phonology, Grammar, Texts and Glossary*. The Hague: Indiana University, Bloomington.
- Selkirk, Elisabeth (1980a). Prosodic domains in phonology: Sanskrit revisited. In Mark Aronoff & Mary-Louise Kean (eds.) *Juncture: A Collection of Original Papers*, Saratoga, CA: Anma Libri. 107–129.
- Selkirk, Elisabeth (1980b). The role of prosodic categories in English word stress. *Linguistic Inquiry* **11**. 563–606.
- Selkirk, Elisabeth (1984). *Phonology and syntax: the relation between sound and structure*. Cambridge, MA: MIT Press.
- Selkirk, Elisabeth (2000). The interaction of constraints on prosodic phrasing. In Merle Horne (ed.) *Prosody: Theory and Experiment*, Dordrecht: Kluwer. 231–262.
- Shaw, Patricia A. (1991). Consonant harmony systems: The special status of coronal harmony. In Carole Paradis & Jean-François Prunet (eds.) *The special status of coronals: Internal and external evidence*, San Diego, CA: Academic Press. 125–158.
- Simonović, Marko (2009). *Immigrants Start on the Periphery: A Unified Approach to Loanword Phonology*. Master's thesis, Utrecht University, Utrecht.
- Simpson, Adrian P. (2001). Dynamic consequences of differences in male and female vocal tract dimensions. *The Journal of the Acoustical society of America* **109**. 2153–2164.
- Siptár, Péter (1996). A Janus-faced Hungarian consonant. *The Even Yearbook* **2**. 83–96.
- Siptár, Péter & Miklós Törkenczy (2000). *The Phonology of Hungarian*. Oxford: Oxford University Press.

- Skousen, Royal (1972). Finnish vowel harmony: rules and conditions. In Michael Kenstowicz & Charles Kisseberth (eds.) *Issues in phonological theory*, The Hague: Mouton de Gruyter. 118–129.
- Sluijter, Agaath M. C. & Vincent J. van Heuven (1996). Spectral balance as a acoustic correlate of linguistic stress. *The Journal of the Acoustical society of America* **100**. 2471–2485.
- Smith, Jennifer L. (2005). *Phonological Argumentation in Prominent Positions*. New York, London: Routledge.
- Smith, Norval (1999). A preliminary account of some aspects of Leuerbost Gaelic syllable structure. In Harry van der Hulst & Nancy A. Ritter (eds.) *The syllable: Views and Facts*, Berlin: Mouton de Gruyter. 577–630.
- Smolensky, Paul (1993). Harmony, markedness, and phonological activity. Paper presented at Rutgers Optimality Workshop 1, Rutgers University. Available on Rutgers Optimality Archive, ROA 87, <http://roa.rutgers.edu>.
- Smolensky, Paul (1995). On the structure of the constraint component CON of UG. Paper presented at University of California, Los Angeles. Available on Rutgers Optimality Archive, ROA 86, <http://roa.rutgers.edu>.
- Smolensky, Paul (1997). Constraint interaction in generative grammar II: Local conjunction, or random rules in Universal Grammar. Paper presented at Hopkins Optimality Theory Workshop/Maryland Mayfest, Baltimore, MD.
- Smolensky, Paul (2006). Optionality in phonology II: harmonic completeness, local constraint conjunction, and feature domain markedness. In *The Harmonic Mind: From Neural Computation to Optimality-Theoretic Grammar*, Cambridge, MA: MIT Press. 27–160.
- Sprouse, Ronald (1997). A case for Enriched Inputs. Ms., University of California Berkeley. Available on Rutgers Optimality Archive, ROA 193, <http://roa.rutgers.edu>.
- Srebot Rejec, Tatjana (1981). On the allophones of /v/ in Standard Slovene. *Scando-Slavica* **27**. 233–241.
- Stanley, Richard (43). Redundancy rules in phonology. *Language* **2**. 393–436.
- Steriade, Donca (1979). Vowel harmony in Khalkha Mongolian. In Ken Safir (ed.) *MIT Working Papers in Linguistics 1: Papers on Syllable Structure, Metrical Structure and Harmony Processes*, Cambridge, MA: MITWPL. 25–50.

- Steriade, Donca (1981). Parameters of metrical vowel harmony rules. Ms. Massachusetts Institute of Technology.
- Steriade, Donca (1982). *Greek Prosodies and the Nature of Syllabification*. Ph.D. dissertation, Massachusetts Institute of Technology, Cambridge.
- Steriade, Donca (1986). Yokuts and the vowel place. *Linguistic Inquiry* 17. 129–146.
- Steriade, Donca (1987a). Locality conditions and feature geometry. In *Proceedings of NELS 17*, Amherst: GLSA, University of Massachusetts. 595–618.
- Steriade, Donca (1987b). Redundant values. In Anna Bosch, Barbara Need & Eric Schiller (eds.) *Chicago Linguistic Society (CLS) 23-2: Parasession on Autosegmental and Metrical Phonology*, Chicago: Chicago Linguistic Society. 339–362.
- Steriade, Donca (1995). Underspecification and markedness. In John A. Goldsmith (ed.) *The Handbook of Phonological Theory*, Oxford: Blackwell. 114–174.
- Steriade, Donca (2001). Directional asymmetries in place assimilation: A perceptual account. In Elizabeth V. Hume & Keith Johnson (eds.) *The role of speech perception in phonology*, New York: Academic Press. 219–250.
- Steriade, Donca (2001/2008). The phonology of perceptibility effects: The P-map and its consequences for constraint organization. In Kristin Hanson & Sharon Inkelas (eds.) *The Nature of the Word: Essays in Honor of Paul Kiparsky*, Cambridge, MA: MIT Press. 151–180.
- Suzuki, Keiichiro (1998). *Phonological Investigation of Dissimilation*. Ph.D. dissertation, University of Arizona, Tucson, AZ.
- Svantesson, Jan-Olof (1985). Vowel harmony shift in Mongolian. *Lingua* 67. 283–327.
- Svantesson, Jan-Olof, Anna Tsendina, Anastasia Karlsson & Vivian Franzén (2005). *The Phonology of Mongolian*. Oxford: Oxford University Press.
- Tang, Katrina (2008). *The Phonology and Phonetics of Consonant-Tone Interaction*. Ph.D. dissertation, University of California, Los Angeles. Available on Rutgers Optimality Archive, ROA 974, <http://roa.rutgers.edu>.
- Ternes, Elmar (1973). *The Phonemic Analysis of Scottish Gaelic: Based on the Dialect of Applecross, Ross-shire*. Hamburg: Helmut Buske Verlag.

- Tesar, Bruce (1995). *Computational Optimality Theory*. Ph.D. dissertation, University of Colorado, Boulder. Available on Rutgers Optimality Archive, ROA 90, <http://roa.rutgers.edu>.
- Tesar, Bruce & Paul Smolensky (1998). Learnability in Optimality Theory. *Linguistic Inquiry* **2**.
- Tesar, Bruce & Paul Smolensky (2000). *Learnability in Optimality Theory*. Cambridge, MA: MIT Press.
- Thráinsson, Höskuldur (1994). Icelandic. In Ekkegard König & Johan van der Auwera (eds.) *The Germanic Languages*, London, New York: Routledge. 142–189.
- Tivadar, Hotimir (1999). Fonem /v/ v slovenskem govorjenem knjižnem jeziku. *Slavistična revija* **47**. 341–361.
- Topintzi, Nina & Marc van Oostendorp (2009). Resolving some paradoxes through binary feature spans. Paper presented at the 6th Old World Conference in Phonology (Edinburgh, January 23, 2009).
- Toporišič, Jože (1976/2000). *Slovenska slovnica*. Maribor: Obzorja.
- Topping, Donald M. (1968). Chamorro vowel harmony. *Oceanic Linguistics* **7**. 67–79.
- Trail, Robert L. (nd). *Kalasha-English Dictionary*. Islamabad: NIPS-SIL.
- Trubetzkoy, N. S. (1939). *Grundzüge der Phonologie*, vol. 7. Prague: Travaux de Cercle Linguistique de Prague.
- Truckenbrodt, Hubert (2007). The syntax-phonology interface. In Paul de Lacy (ed.) *The Cambridge Handbook of Phonology*, Cambridge: Cambridge University Press. 435–456.
- Truckenbrodt, Hubert & Filomena Sandalo (2002). Some notes on phonological phrasing in Brazilian Portuguese. In Anikó Csirmaz, Zhiqiang Li, Andrew Nevins, Olga Vaysman & Michael Wagner (eds.) *MIT Working Papers in Linguistics: Phonological Answers (and their Corresponding Questions)*, Cambridge, MA: MITWPL, vol. 42. 285–310.
- Tsuchida, Ayako (2001). Japanese vowel devoicing: Cases of consecutive devoicing environments. *Natural Language and Linguistic Theory* **10**. 225–245.

- Tucker, Archibald N. (1964). Kalenjin phonetics. In David Abercrombie, D. B. Fry, N. C. MacCarthy, N. C. Scott & J. L. M. Trim (eds.) *In Honour of Daniel Jones*, London: Longmans. 445–470.
- Tuller, Betty, Katherine S. Harris & J. A. Scott Kelso (1982). Stress and rate: Differential transformations of articulation. *The Journal of the Acoustical Society of America* **71**. 1534–1543.
- Uffmann, Christian (2005). Optimal geometries. In Marc van Oostendorp & Jeroen van de Weijer (eds.) *The internal structure of phonological segments*, Mouton de Gruyter. 27–62.
- Uffmann, Christian (2006). Epenthetic vowel quality in loanwords: Empirical and formal issues. *Lingua* **116**. 1079–1111.
- Underhill, Robert (1976). *Turkish Grammar*. Cambridge, MA: MIT Press.
- Urbanczyk, Suzanne (2006). Reduplicative form and the root-affix asymmetry. *Natural Language and Linguistic Theory* **24**. 179–240.
- Ussishkin, Adam (2000). *The emergence of fixed prosody*. Ph.D. dissertation, University of California, Santa Cruz, Santa Cruz, CA.
- Vago, Robert (1976). Theoretical implications of Hungarian vowel harmony. *Linguistic Inquiry* **7**. 243–263.
- Vago, Robert (1978). Some controversial questions concerning the description of vowel harmony. *Linguistic Inquiry* **9**. 116–125.
- Vago, Robert (1980a). A critique of suprasegmental theories of vowel harmony. In Robert Vago (ed.) *Issues in vowel harmony*, Amsterdam: John Benjamins. 155–181.
- Vago, Robert (1980b). *The Sound Pattern of Hungarian*. Washington, DC: Georgetown University Press.
- Vago, Robert (1988). Vowel harmony in Finnish word games. In Harry van der Hulst & Norval Smith (eds.) *Features, Segmental Structure and Harmony Processes (Part II)*, Dordrecht: Foris. 185–205.
- Vago, Robert & Harry Leder (1987). On the autosegmental analysis of vowel harmony in Turkana. In David Odden (ed.) *Current Approaches to African Linguistics: Volume 4*, Dordrecht: Foris. 383–395.

- Välilmaa-Blum, Ritta (1987). Finnish vowel harmony as a prescriptive and descriptive rule: An autosegmental account. In Fred Marshall, Ann Miller & Zhen-Sheng Zhang (eds.) *Eastern States Conference on Linguistics (ESCOL '86)*, Columbus, OH: Ohio State University. 511–522.
- Välilmaa-Blum, Ritta (1999). A feature-geometric description of Finnish vowel harmony covering both loans and native words. *Lingua* **108**. 247–268.
- van der Hulst, Harry (1985). Vowel harmony in Hungarian: a comparison of segmental and autosegmental analyses. In Harry van der Hulst & Norval Smith (eds.) *Advances in Nonlinear Phonology*, Dordrecht: Foris. 267–303.
- van der Hulst, Harry (1989). Atoms of segmental structure: Components, gestures and dependency. *Phonology* **6**. 253–284.
- van der Hulst, Harry (2010). A note on recursion in phonology. In Harry van der Hulst (ed.) *Recursion in Human Language*, Berlin: Mouton de Gruyter. 301–342.
- van der Hulst, Harry & Norval Smith (1982). Prosodic domains and opaque segments in Autosegmental Theory. In Harry van der Hulst & Norval Smith (eds.) *The Structure of Phonological Representations (Part II)*, Dordrecht: Foris. 311–336.
- van der Hulst, Harry & Norval Smith (1986). On neutral vowels. In Koen Bogers, Harry van der Hulst & Maarten Mous (eds.) *The Phonological Representation of Suprasegmentals*, Dordrecht: Foris. 233–279.
- van der Hulst, Harry & Norval Smith (1987). Vowel harmony in Khalkha and Buriat (East Mongolian). In *Linguistics in the Netherlands*, Dordrecht: Foris. 81–89.
- van der Hulst, Harry & Jeroen van de Weijer (1991). Topics in Turkish phonology. In Hendrik Boeschoten & Ludo Verhoeven (eds.) *Turkish Linguistics Today*, Leiden: Brill. 11–59.
- van der Hulst, Harry & Jeroen van de Weijer (1995). Vowel harmony. In John A. Goldsmith (ed.) *The Handbook of Phonological Theory*, Cambridge, MA: Blackwell. 495–534.
- van Oostendorp, Marc (2005). The theory of faithfulness. Ms. Meertens Institute.
- van Oostendorp, Marc (2007). Derived Environment Effects and Consistency of Exponence. In Sylvia Blaho, Patrik Bye & Martin Krämer (eds.) *Freedom of*

- Analysis?*, Berlin and New York: Mouton de Gruyter. 123–148. Available on Rutgers Optimality Archive, ROA 851, <http://roa.rutgers.edu>.
- Van Son, R. J. J. H. & Louis C. W. Pols (1992). Formant movements of Dutch vowels in text, read at normal and fast rate. *The Journal of the Acoustical society of America* **92**. 121–127.
- Vaysman, Olga (2008). *Segmental Alternations in Metrical Theory*. Ph.D. dissertation, Massachusetts Institute of Technology, Cambridge. Available on Rutgers Optimality Archive, ROA 1011, <http://roa.rutgers.edu>.
- Vergnaud, Jean-Roger (1979). A formal theory of vowel harmony. In *University of Massachusetts Occasional Papers in Linguistics 5*, Amherst: GLSA, University of Massachusetts. 135–143.
- Walker, Rachel (1993). A feature hierarchy for contrastive specification. *Toronto Working Papers in Linguistics* **12**. 179–197.
- Walker, Rachel (1995). Hierarchical opacity effects in nasal harmony. In Janet Fuller, Ho Han & David Parkinson (eds.) *Proceedings of the Eleventh Eastern States Conference on Linguistics*, Ithaca, NY: DMLL Publications. 318–329.
- Walker, Rachel (1998). *Nasalization, Neutral Segments, and Opacity Effects*. Ph.D. dissertation, University of California, Santa Cruz. Available on Rutgers Optimality Archive, ROA 405, <http://roa.rutgers.edu>.
- Walker, Rachel (1998/2000). *Nasalization, Neutral Segments, and Opacity Effects*. New York: Garland.
- Walker, Rachel (1999). Guaraní voiceless stops in oral versus nasal contexts: an acoustical study. *Journal of the International Phonetic Association* **29**. 63–94.
- Walker, Rachel (2001). Round licensing, harmony, and bisyllabic triggers in Altaic. *Natural Language and Linguistic Theory* **19**. 827–878.
- Walker, Rachel (2003). Reinterpreting transparency in nasal harmony. In Jeroen van de Weijer, Vincent J. van Heuven & Harry van der Hulst (eds.) *The Phonological Spectrum 1: Segmental Structure*, Amsterdam: John Benjamins. 34–72.
- Walker, Rachel (2004). Vowel feature licensing at a distance: Evidence from northern Spanish language varieties. In Benjamin Schmeister, Vineeta Chand, Ann Kelleher & Angelo J. Rodríguez (eds.) *Proceedings of the 23<sup>rd</sup> West Coast Conference on Formal Linguistics*, Somerville, MA: Cascadilla Press. 787–800.

- Walker, Rachel (2005). Weak triggers in vowel harmony. *Natural Language and Linguistic Theory* **23**. 917–989.
- Walker, Rachel (2009). (Non-)adjacency in harmony systems. Paper presented at the 45th meeting of the Chicago Linguistic Society.
- Walker, Rachel, Dani Byrd & Fidèle Mpiranya (2008). An articulatory view of Kinyarwanda coronal harmony. *Phonology* **25**. 499–535.
- Walker, Rachel & Geoffrey Pullum (1999). Possible and impossible segments. *Language* **75**. 764–780.
- Watson, Janet C. E. (1999). The directionality of emphasis spread in Arabic. *Linguistic Inquiry* **30**. 289–300.
- Watson, Janet C. E. (2002). *The Phonology and Morphology of Arabic*. Oxford: Oxford University Press.
- Wayment, Adam (2009). *Assimilation as Attraction: Computing Distance, Similarity, and Locality in Phonology*. Ph.D. dissertation, Johns Hopkins University, Baltimore, MD.
- Wetzels, Leo & Joan Mascaró (2001). The typology of voicing and devoicing. *Language* **77**. 207–244.
- Wheeler, Max W. (1979). *Phonology of Catalan*. Oxford: Blackwell.
- Wheeler, Max W. (2005). *The Phonology of Catalan*. Oxford: Oxford University Press.
- Whitney, William Dwight (1889). *Sanskrit Grammar: Including both the Classical Language, and the older Dialects, or Veda and Brahmana*. Cambridge, MA: Harvard University Press.
- Wightman, Colin W., Stefanie Shattuck-Hufnagel, Mari Ostendorf & Patti J. Price (1992). Segmental durations in the vicinity of prosodic phrase boundaries. *Journal of the Acoustical Society of America* **91**. 1707–1717.
- Wilson, Colin (2000). *Targeted Constraints: An Approach to Contextual Neutralization in Optimality Theory*. Ph.D. dissertation, Johns Hopkins University, Baltimore, MD.
- Wilson, Colin (2001). Consonant cluster neutralization and targeted constraints. *Phonology* **18**. 147–197.



- Wolf, Matthew Adam (2008). *Optimal Interleaving: Serial Phonology-Morphology Interaction in a Constraint-Based Model*. Ph.D. dissertation, University of Massachusetts, Amherst. Available on Rutgers Optimality Archive, ROA 996, <http://roa.rutgers.edu>.
- Wu, Ke & D. G. Childers (1991). Gender recognition from speech. Part I: Coarse analysis. *The Journal of the Acoustical society of America* **90**. 1828–1840.
- Wurm, Stefan (1949). The (Kare-)Kirghiz language. *Bulletin of the School of Oriental and African Studies, University of London* **13**. 97–120.
- Yamada, Norio (1983). A constraint on phonological variables. *Linguistic Analysis* **12**. 29–84.
- Yip, Moira (1988). The Obligatory Contour Principle and phonological rules: A loss of identity. *Linguistic Inquiry* **19**. 65–100.
- Yip, Moira (1989). Cantonese morpheme structure and linear ordering. In Jane E. Fee & Katherine Hunt (eds.) *Proceedings of the 8th West Coast Conference on Formal Linguistics*, Stanford, CA: Stanford Linguistics Association. 445–456.
- Yip, Moira (2002). *Tone*. Cambridge: Cambridge University Press.
- Youssef, Islam (2010). Against underlying mid vowels in Cairene Arabic. *Zeitschrift für Arabische Linguistik* **52**. 5–38.
- Youssef, Islam (to appear). Laryngeal assimilation in Buchan Scots. *Journal of English Language and Linguistics* **14**.
- Zawaydeh, Bushra (1999). *The phonetics and phonology of gutturals in Arabic*. Ph.D. dissertation, Indiana University, Bloomington.
- Zec, Draga (1988/1994). *Sonority Constraints on Prosodic Structure*. New York: Garland.
- Zec, Draga (1995). Sonority constraints on prosodic structure. *Phonology* **12**. 85–129.
- Zec, Draga (1999). Footed tones and tonal feet: rhythmic consistency in a pitch-accent language. *Phonology* **16**. 225–264.
- Zoll, Cheryl (1993). Directionless syllabification and ghosts in Yawelmani. Ms., University of California Berkeley. Available on Rutgers Optimality Archive, ROA 143, <http://roa.rutgers.edu>.

- Zoll, Cheryl (1998a). *Parsing Below the Segment in a Constraint-based Framework*. Stanford, CA: CSLI Publications.
- Zoll, Cheryl (1998b). Positional asymmetries and licensing. Ms., Massachusetts Institute of Technology. Available on Rutgers Optimality Archive, ROA 282, <http://roa.rutgers.edu>.
- Zonneveld, Wim (1980). Hungarian vowel harmony and the theory of exceptions in generative phonology. *Linguistic Analysis* **6**. 21–39.
- Zubizarreta, Maria Luisa (1979). Vowel harmony in Andalusian Spanish. In Ken Safir (ed.) *MIT Working Papers in Linguistics 1: Papers on Syllable Structure, Metrical Structure and Harmony Processes*, Cambridge, MA: MITWPL. 1–11.
- Zubizarreta, Maria Luisa (1982). The formal interaction of harmony and accent: The tone pattern in Japanese. In Harry van der Hulst & Norval Smith (eds.) *The Structure of Phonological Representations (Part II)*, Dordrecht: Foris. 159–212.





ISBN xxx-xx-xxxx-xxx-x