



UNIVERSITY OF TROMSØ  
FACULTY OF HEALTH SCIENCE  
DEPARTMENT OF PHARMACY

# **Molecular targets and biological effects of PAX6 in lung cancer**

---

**Charles Johannessen**

A master thesis in  
Medical laboratory science  
May 2013

## Contents

Summary .....	4
Abbreviations.....	5
Introduction .....	6
Lung cancer .....	6
Non-small cell lung cancer .....	7
Molecular mechanisms in NSCLC .....	8
The Paired box genes.....	10
The transcription factor PAX6 .....	10
Function .....	11
Transcription factors and cancer.....	12
Known targets of PAX6.....	13
PAX6 and cancer.....	14
PAX6 and lung cancer .....	15
Aim of study .....	16
Materials and Methods .....	17
Materials .....	17
Methods .....	21
Cell Culture techniques .....	21
Transfecting siRNA .....	22
Total RNA isolation.....	23
NanoDrop .....	23
cDNA synthesis.....	24
Quantitative real-time PCR (qPCR).....	25
Primer design .....	27
SDS-PAGE .....	27

Western Blot .....	27
Real-time monitoring of cells - xCELLigence® .....	28
Real-time monitoring of cells – IncuCyte® .....	29
In-Cell Western™ (ICW) .....	31
Results .....	32
Transfection of PAX6 siRNA and SCR siRNA .....	32
Real-Time PCR (qPCR) .....	34
Western blot .....	37
Real-time monitoring of cells - xCELLigence® .....	39
Proliferation study .....	39
Migration study .....	40
Real-time monitoring of cells – IncuCyte® .....	41
Proliferation study .....	41
Migration study .....	42
Apoptosis study .....	43
Discussion .....	44
Comparative qPCR .....	45
Western blot .....	46
Real-time monitoring of cells .....	47
Relevance of findings .....	49
Future perspective .....	51
References .....	52

## **Acknowledgements**

This work was done at the Research Group of Molecular Pharmacology, Dept of Pharmacy, University of Tromsø, and I am grateful to all the staff and in particular Prof. Ole Morten Seternes for his generous permission to use the lab equipment and premises.

I would like to thank my supervisor Dr. Yury Kiselev for his support, impressive knowledge and excellent supervision. I also would like to thank my co-supervisor Dr. Ingvild Mikkola for welcoming me in her lab, for her outstanding knowledge and critical yet kind review of my work.

I would like to thank all the members of the research group for the positive atmosphere and the good scientific and social environment in the laboratory. A special thanks goes to Rune Hogseth for all his technical support and help.

Finally I would like to thank my family and friends for their support.

Tromsø, 15.05.2013

Charles Johannessen

## **Summary**

Lung cancer is by far the leading cause of cancer-related mortality worldwide regardless of sex, and has a dismal overall 5-year survival rate of approximately 15%. More than 85% of all lung cancers are non-small cell lung cancer (NSCLC), and about 50% of these are adenocarcinomas. Targeted treatment has shown promising results in treating certain types of NSCLC, but the overall survival is still frustratingly low. PAX6 is a transcription factor that has very recently been shown to have positive effect on survival when expressed in lung cancer. We want to identify potential target genes for PAX6 that can explain this observation, and possibly provide a greater understanding of the molecular mechanisms involved in the pathogenesis of non-small cell lung cancer. PAX6 expression was knocked-down in lung cancer cell lines, and expression of some cancer-associated genes in PAX6-knockdown samples was compared with expression in control samples. Expression was studied on gene level, using comparative qPCR and on protein-level, using western blot. Cell behaviour after PAX6 knockdown was studied in real-time using two different systems designed for this purpose. Our results show that PAX6 does regulate a number of cancer associated genes, and that PAX6 has influence on cell proliferation, migration and apoptosis of lung cancer cell lines.

## Abbreviations

NSCLC	Non-small cell lung cancer
PAX	Paired box
DNA	Deoxyribonucleic acid
cDNA	Comparative DNA
RNA	Ribonucleic acid
mRNA	Messenger RNA
PD	Paired domain
HD	Homeodomain
TAD	Transcriptional activation domain
TF	Transcription factor
ICW	In-Cell western
GFP	Green fluorescent protein
siRNA	Small interfering RNA
SCR	Scrambled
SDS-PAGE	Sodium dodecyl sulfate polyacrylamide gel electrophoresis
WB	Western blot
bp	Base pair
Ct	Cycle threshold
Q-PCR	Quantitative polymerase chain reaction

## **Introduction**

### **Lung cancer**

Cancer is a general term for a large group of diseases that can affect any part of the body, and the main hallmark of cancer is loss of growth control. Other terms used are malignant tumours and neoplasms. One defining feature of cancer is the rapid creation of abnormal cells that grow beyond their usual boundaries, and which can then invade adjoining parts of the body and spread to other organs, a process referred to as metastasis [1]. Metastases are the major cause of death from cancer. Cancer typically arises from one single cell, and the transformation from a normal cell into a tumour cell is a multistage process, typically from a pre-cancerous lesion to malignant tumours [2].

Lung cancer is a cancer that is characterized by uncontrolled malignant cell growth in lung tissue (lungs and bronchia). Lung cancer is by far the leading cause of cancer-related mortality worldwide regardless of sex, and has a dismal overall 5-year survival rate of approximately 15% [3]. Earlier, lung cancer in men was more frequent than in woman, but in the past years this difference has been evened out – probably as a consequence of the increase in women smokers, and lung cancer now kills more woman than does breast cancer, ovarian cancer and uterine cancer put together [4]. Traditional treatment of lung cancer includes surgery, radiation, chemotherapy, palliative care, alone or in combination in an attempt to cure or lessen the adverse impact of malignant neoplasm originating in lung tissue [5]. In the last decade there has been achieved significant progress in research in the molecular mechanisms involved in lung cancer, and new drugs are currently in use, tested and developed. Disappointingly, not much improvement in survival has been achieved even with the most recent expensive molecular therapies, such as anti-angiogenic drugs. The poor survival rate of patients with lung cancer makes specialized/individualized medicine a potential revolution in the treatment of lung cancer.

Lung cancers are classified according to histological type. This classification has important implications for clinical management and prognosis of the disease. The vast majority of lung cancers are carcinomas—malignancies that arise from epithelial cells. The two most prevalent histological types of lung carcinoma, categorized by the size and appearance of the malignant cells, are non-small cell lung carcinoma (NSCLC) and small-cell lung carcinoma (SCLC) [6]. Small-cell lung carcinoma (SCLC) is less common than non-small cell lung cancer, and most cases arise in the larger airways (primary and secondary bronchi), grow rapidly and become relatively large [3].

## **Non-small cell lung cancer**

About 85% to 90% of lung cancers are non-small cell lung cancer. There are three main subtypes of NSCLC, and the cells in these subtypes differ in size, shape, and chemical makeup when looked at under a microscope. But they are grouped together because the approaches to treatment and prognosis are very similar [7]. The most common types of NSCLC are adenocarcinoma, squamous cell carcinoma and large cell carcinoma, but there are several other types that occur less frequently, and all types can occur in unusual histologic variants and as mixed cell-type combinations [7].

Adenocarcinoma of the lung is the most frequent histological form of lung cancer, and it contains several distinct malignant tissue architectural, cytological, or molecular features, including gland and/or duct formation and/or production of significant amounts of mucus [3].

Squamous cell lung carcinoma is a cancer of a type of epithelial cell, the squamous cell. Squamous cell carcinoma lesions are thought to originate from uncontrolled division of cancer stem cells of epithelial lineage or characteristics [3]. Accumulation of these cancer cells cause a microscopic focus of abnormal cells that are, at least initially, locally confined within the specific tissue in which the progenitor cell resided. This condition is called squamous cell carcinoma in situ, and it is diagnosed when the tumor has not yet penetrated the basement membrane [3].

Large-cell lung carcinoma is a heterogeneous group of undifferentiated malignant neoplasms originating from transformed epithelial cells in the lung. Large-cell lung carcinoma is a diagnosis of exclusion made after ruling out the presence of components of squamous cell lung carcinoma, adenocarcinoma of the lung and small cell lung carcinoma [3].



## Molecular mechanisms in NSCLC

The fact that lung cancer is a highly heterogeneous form of malignancy has become more apparent over the last decade. This group of malignant tumours are in general associated with high degree of aggressiveness, and a poor prognosis. However, the molecular modifications driving lung cancer progression have over the last few years become clearer, and the discovery of these mechanisms has resulted in specialized targeted therapies with tyrosine-kinase inhibitors (TKIs), especially for the

epidermal growth factor receptor (EGFR), which is mutated in a significant numbers of non-small cell lung cancers [8]. The current approach is to divide different type of cancers in to molecular subtypes, which is defined as tumours harbouring the same set of molecular defects and their associated pathways [9].

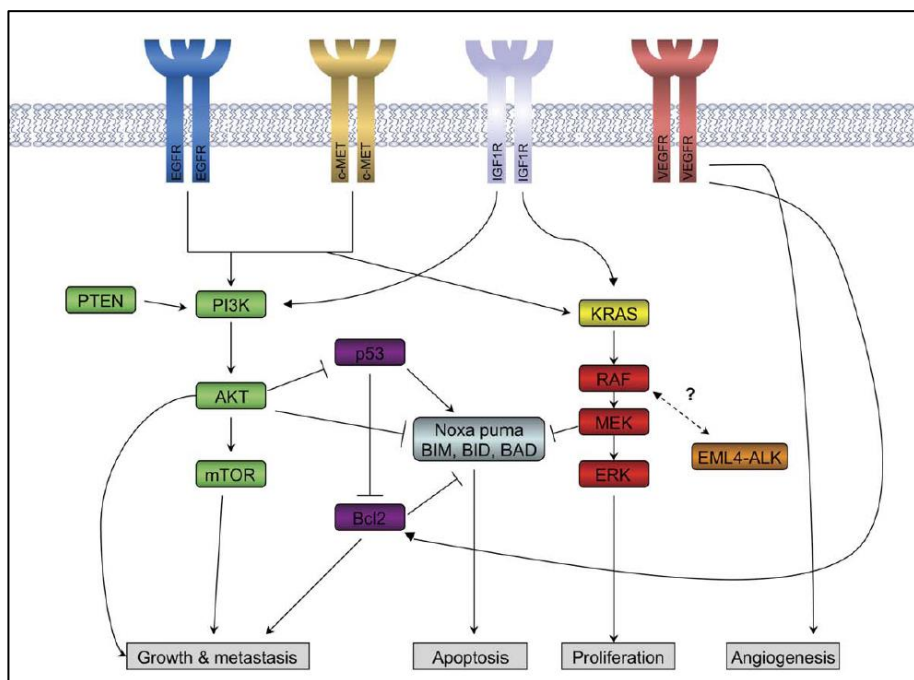


Figure 1: The most common molecular pathways in lung cancer (modified from West L, et al. 2011)

The epidermal growth factor receptor (EGFR) is a transmembrane protein in the ErbB family of tyrosine kinases, and it binds to epidermal growth factor (EGF) and other growth factors to activate [8]. Activation of the receptor triggers the tyrosine kinase activity, which in turn activates downstream pathways, including the Akt/PI3K and the Ras/MAPK pathways, leading to DNA synthesis and cell proliferation [9]. The EGFR has indeed been shown to be dysregulated by various molecular mechanisms in NSCLC, including overexpression, amplification or by mutations [10]. The most common mutations of the EGFR is the in-frame deletion of exon 19 (44% of EGFR mutations) and the single amino acid change L858R (41% of EGFR mutations) [10]. However, in the case of squamous cell carcinoma, mutations in the EGFR is relatively rare (<3.6%) [9].

Mutations in the K-ras gene are another powerful driver in lung cancer progress. The K-ras protein possesses essential GTPase activity, and belongs to a family of GTPases that are involved in regulation of cellular behaviour in response to extracellular stimuli [9]. The K-ras pathway regulates several processes, such as proliferation, differentiation, adhesion, apoptosis and migration [11]. The oncogenic effect of K-ras is due to point mutations leading to constitutive activation of K-ras protein via alterations in the GTP-binding domain, preventing the conversion of GTP to GDP [11].

Alterations in the c-MET pathway also have oncogenic effects in NSCLC. Mutations in the c-MET pathway is characterized by dysregulation of mesenchymal-epithelial transition factor receptor tyrosine kinase (c-MET), which is a proto-oncogene encoding the tyrosine kinase membrane receptor hepatocyte growth factor receptor (HGFR) [12]. Dysregulation of this pathway leads to increased cell proliferation, cell survival, angiogenesis, invasion and metastasis. This dysregulation may occur via a variety of mechanisms, including c-MET overexpression, activation, overexpression of the hepatocyte growth factor ligand (HGF) and gene amplification. [13].

Aberrations in the AKT/PI3K pathway also constitute effects in cancer progression. PI3K acts as an antagonist on the lipid phosphatase PTEN to balance the amount of the two signalling molecules PIP2 and PIP3 [9]. Upon growth factor stimulation, PI3KCA is triggered, leading to increasing PIP3 levels which in turn drives phosphorylation of AKT and its downstream processes [9]. In lung cancer, the amplification of the PI3KCA gene occurs at a much higher rate than does activating mutations.

Dysregulation in the vascular endothelial growth factor (VEGF) pathway is another important driver in lung cancer progression. The VEGF pathway regulates vascular angiogenesis, and tumours exploit this pathway to promote self-survival and proliferation [9]. An important downstream effect of the VEGF pathway is the activation of B-cell lymphoma 2 (Bcl-2), which is an anti-apoptotic regulator protein that has been associated with a number of cancers, including lung cancer [14]. The VEGF is the ligand for the vascular endothelial growth factor receptor (VEGFR), which is an important signalling protein involved in vasculogenesis (the formation of new blood vessels occurring by a de novo production of endothelial cells) and angiogenesis (the formation of new blood vessels from pre-existing vessels).

Another subtype which has been observed, predominantly, in adenocarcinomas, includes the EML4-ALK oncogene. EML4-ALK is a fusion oncogene, consisting of echinoderm microtubule-

associated protein-like 4 (EML4) and anaplastic lymphoma kinase (ALK) [15]. This fusion oncogene creates a transforming tyrosine kinase, with nine unique variants currently identified, of which several have been found to play roles in lung cancer progression [16].

## The Paired box genes

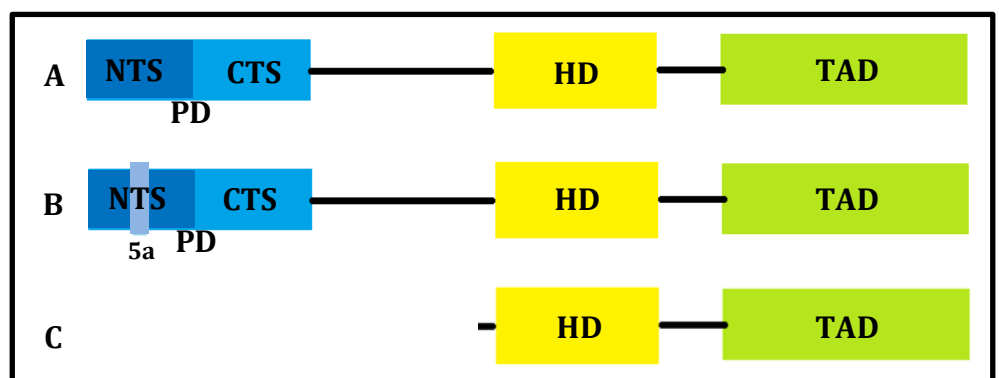
The Paired box genes (PAX-genes) comprise a family of key transcription factors that play essential roles during development as tissue specific trans-activating regulators. The PAX-genes are defined with a 128 amino acid long paired domain, encoding a unique DNA-binding motif [17]. The paired box was first identified in three segmentation and two tissue-specific genes in *Drosophila*, and homologs have been found in a variety of vertebrates and invertebrates [18]. PAX expression is observed primarily in conjunction with embryo development, where they promote cell proliferation, cell differentiation, cell migration and survival [19]. In most tissues, PAX expression is reduced/terminated as the embryo development is complete, but some tissue continue to express PAX genes also after embryogenesis [19]. The PAX genes function often by binding to enhancer sequences on the DNA, and subsequently modify transcriptional activity of downstream genes [20].

## The transcription factor PAX6

PAX6 is a highly conserved transcription factor comprised of two DNA binding domains; a paired domain (PD) and a homeodomain (HD), which can bind DNA independently or they can act together to mediate transcription [21]. The paired domain is a bipartite binding domain and is composed of a N-terminal and a C-terminal subdomain (NTS and CTS) which bind two distinct

half-sites in adjacent minor grooves of the DNA helix [22]. The paired domain appears to be more important for specific DNA binding and its biological consequences than the homeodomain [22]. The C-terminal part of PAX6

functions as a transcriptional activation domain (TAD). The PAX6 transcription factor has two isoforms - the PAX6(5a) and the PAX6 $\Delta$ PD. The PAX6(5a) isoform is a splice variant of PAX6



**Figure 2: Schematic presentation of PAX6 and its isoforms.** A) The PAX6 gene. B) The PAX6(5a) gene. C) The PAX6  $\Delta$ PD gene.

containing a 14 amino acid insertion in the N-terminal part of the PD (Figure 1B), resulting in a different DNA binding specificity [23], and the PAX6  $\Delta$ PD isoform lacks the PD domain, and consists only of the HD domain and the TAD domain. Tissue-specific transcription and alternative splicing of PAX6 mRNA is controlled by a complex regulatory mechanism, and PAX6 has an ability to participate in multiple molecular interactions [24].

## **Function**

PAX6 plays a central role in the organogenesis of the central nervous system, visual and other sensory organs, as well as endocrine part of the pancreas. Several studies have shown that PAX6 is essential for morphogenesis of the eye, from its earliest stages and subsequent formation of all major ocular tissues [25]. It also plays a key role for endocrine cell differentiation and function, as it has been shown that PAX6 mutations are associated with a diabetic phenotype, showing a significant decrease in insulin-positive cell number [26]. From the very discovery of PAX6, its function in development has been studied by examining the phenotype and gene expression profiles of several mutant lines of mice and rats, and by promoter binding studies.

## **Transcription factors and cancer**

In short, transcription factors are DNA-binding proteins that control the transcription of genetic information from DNA to mRNA, yet these proteins do not have enzymatic activity. Transcription factors utilize this function unaided or as part of a larger protein complex. The main feature of TFs is their DNA-binding domains which bind to specific target sequences in proximity, or directly within, the gene(s) they regulate, and they are able to promote or inhibit transcription, mainly by initializing or blocking recruitment of RNA polymerase to the site of transcription [27].

There are three most studied and known groups of transcription factors which are of importance in cancer. The first group of transcription factors are the steroid receptors, which include the oestrogen receptor (important in breast cancer) and the androgen receptor (important in prostate cancer) [28]. The second group of cancer associated transcription factors are resident nuclear proteins, which are activated by serine kinase cascades. An example is the AP-1 transcription factor, which is activated through the JNK pathway, and has importance in cell proliferation and apoptosis [29]. The third group is the dormant cytoplasmic transcription factors, whose activation is normally initiated through receptor-ligand binding on the cell surface, and despite the divergence in detail in this group, they are similar in that a protein-protein interaction on the cell surface is triggering the cytoplasmic event, which in turn results in the transportation of proteins to the cell nucleus causing increased transcription in association with other proteins that effect the initiation of gene transcription [30]. Overexpression and/or uncontrolled activity of one or more transcription factors from within these groups is showed to have influence on survival, uncontrolled growth and migration/invasion behaviour in close to all human cancers [30].

## Known targets of PAX6

The role of PAX6 in the development of brain, eyes, nose and pancreas during embryogenesis is well known, but it also has a poorly understood role in cancer initiation and/or tumor progression. The expression of PAX6 is observed in many human cancer cell lines and has been detected in clinical samples of at least three different types of cancer. It appears to participate in control of cell proliferation, invasion, apoptosis and also other functions. However, relatively little is known about which genes the PAX6 transcription factor regulates in regard to cancer. One has to remember that a particular TF might regulate a given gene in one tissue and have no effect in another tissue. The first and earliest group of PAX6 target genes include a group belonging to the anatomical locations where PAX6 is expressed during embryogenesis. Table 1 shows a list of target genes, and where they are expressed.

**Table 1: List of some PAX6-regulated genes**

Location	Gene	Reference
<b>Brain</b>	LICAM	Chalepakis et al., 1994
	NCAM	Holst et al., 1997
	Aldolase C	Skala-Rubinson et al., 2002
	Optimedin A	Grinchuk et al., 2005
	R-cadherin	Andrews et al., 2003
	Delta-catenin	Duparc et al., 2006
	Neurogenin 2	Scardigli et al., 2003
<b>Eye</b>	Crystallines	Cvekl et al., 2004
	Six3	Goudreau et al., 2002
	L-maf	Reza et al., 2002
	$\alpha 1 + \alpha 2$ integrins	Duncan et al., 2000
<b>Pancreas</b>	Insulin, glucagon and somatostatin	Sander et al., 1997
<b>Lens</b>	Cspg2, Mab2112, Olfm3, Spag5 and Tgfb2	Wolf et al., 2009
<b>Hindbrain</b>	Unc5h1 and Cyp26b1	Numayama-Tsuruta et al., 2010
<b>Forebrain</b>	Delta-catenin, Satb2, Nfia, AP-2y, NeuroD6, Ngn2, Tbr2, Bhlhb5	Duparc et al., 2006

In addition to the important role of PAX6 in embryogenesis, it is also expressed in some tissues in

adult organism, and has been associated with stem cells in the eye and brain. Furthermore, it is also expressed in several tumours in the brain, pancreas and eye [31-33].

## **PAX6 and cancer**

PAX6 and other members of the PAX family are often expressed in mammalian cancer tissue where PAX6 normally is not endogenous expressed [34]. In normal tissue, the function of PAX6 is associated with regulation of the cell cycle, cell differentiation and cell proliferation [35]. The presence of PAX6 in glioblastomas has been shown to be positive for the clinical outcome, where PAX6 has been shown to repress the expression of MMP2 (a proteinase involved in the breakdown of extracellular matrix), and to make the cells more sensitive to reactive oxygen species (ROS) [32, 36]. Tumour suppressor function was proposed for PAX6 by Robson et al., 2006, though only in a limited number of tissues this function is showed to be fulfilled through inhibition of cell proliferation, invasion and angiogenesis [37]. In contrast, PAX6 knockdown induces apoptosis in pancreatic cancer cells, and expression in pancreatic cancer is thought to prevent cell differentiation, and thus promote tumor growth [38]. Even though PAX6 is expressed in several human malignant tumours, and the effects on proliferation, invasion, apoptosis and other functions related to cancer have been studied, little is known about which cancer associated genes are regulated by PAX6.

In a recent study of malignant glioma cells, PAX6 was found to up regulate the expression of the FABP7 gene, which encodes an intracellular lipid binding protein expressed in radial glial cells during brain development [39]. The expression of this gene in malignant cells that normally don't express it results in increased cell migration, while suppression of FABP7 in malignant cells that normally express this gene, results in decreased cell migration [40]. In grade IV astrocytoma tumours, expression of FABP7 correlates negatively with patient survival [41], rendering PAX6 a driver in the progression in this type of cancer. Unpublished results from Kiselev, Mikkola et al., have also verified several cancer associated genes regulated by PAX6. Table 2 shows a list of these genes and a short description their function.

**Table 2: Cancer-associated genes regulated by PAX6**

<b>Gene</b>	<b>Function</b>
<b>BRCA2</b>	Tumor suppressor gene.
<b>RALB</b>	GTP-binding protein that belongs to the small GTPase superfamily and Ras family of proteins.
<b>SPHK1</b>	Lipid messenger with both intracellular and extracellular functions. Intracellularly it regulates proliferation and survival, and extracellularly it is a ligand for EDG1.
<b>DKK3</b>	Has function as an antagonist in the Wnt signalling pathway
<b>TGFBI</b>	A protein is induced by transforming growth factor-beta and acts to inhibit cell adhesion.
<b>VEGFA</b>	A glycoprotein that plays a significant role in neurons and is considered to be the main, dominant inducer to the growth of blood vessels.

### **PAX6 and lung cancer**

According to unpublished novel results by Kiselev and Busund, immunohistochemical staining detects PAX6 expression in at least 25% of formalin-fixed paraffin-embedded tissue samples of human NSCLC. No previous reports of PAX6 in lung cancer are known in the literature. Expression was found to be restricted to the periphery of the tumour, mainly near the area of contact between malignant and normal tissue. Survival analysis showed that PAX6-positive patients had higher chances for survival than PAX6-negative counterparts. This effect was more prominent for squamous cell tumours. Expression of PAX6 has been also detected in an adenocarcinoma-derived cell line NCI-H460 and squamous-cell carcinoma derived cell line NCI-H661.



## **Aim of study**

The aim of this study was to get a better understating of which molecular mechanisms are regulated by the transcription factor PAX6 in non-small cell lung cancer (NSCLC). Unpublished results have confirmed the expression of PAX6 in some cases of NSCLC, and a better understating of which genes and functions that are regulated by this transcription factor in NSCLC could in future perspectives have value in designing new targeting anti-cancer drugs, or understanding failures of existing therapies. On the background of this, we sought to identify novel cancer-associated target genes for PAX6 in lung cancer by studying the effects on the knockdown of PAX6 in lung cancer cell lines. We also wanted to study the possible effects of PAX6 knockdown on proliferation, migration and apoptosis.

# Materials and Methods

## Materials

**Table 3: Buffers and solutions**

Material	Content	Manufacturer	Purpose
ddH <sub>2</sub> O	Double distilled water		Various
1X PBS	137 mM NaCl, 2.7mM KCl, 10mM Na <sub>2</sub> HPO <sub>4</sub> , 2mM KH <sub>2</sub> HPO <sub>4</sub> , pH 7.4.		Washing of cells, western blotting.
TBS	25 mM Tris, 150 mM NaCl, 2 mM KCl, pH 7.4.		Western Blotting
TBST	TBS + 0.1% Tween 20		Western Blotting
NuPage 20 × running buffer	Working dilution: 1:20	Invitrogen	SDS-PAGE
LDS sample buffer	40 µl 4× NuPAGE LDS buffer, 50 µl H <sub>2</sub> O, 10 µl reducing agent.	Invitrogen	SDS-PAGE
Blotting buffer	800 ml distilled H <sub>2</sub> O, 200 ml Methanol, 29 g Glycine, 5.8 g Tris-base.	Produced at university lab	Western Blotting
Blocking buffer	Not disclosed by manufacturer	Odyssey®	Blocking WB-membrane
3.7% formaldehyde	5 ml 37% formaldehyde, 45 ml 1X PBS.		In-Cell western
0.1% Triton washing solution	5 ml 10% Triton X-100, 495 ml 1X PBS		In-Cell western
70% ethanol	70 ml absolute alcohol + 30 ml ultra-pure water.		RNA isolation
Buffer RLT	Not disclosed by manufacturer.	QIAGEN®	RNA isolation
Buffer RW1	Not disclosed by manufacturer.	QIAGEN®	RNA isolation
Buffer RPE	Not disclosed by manufacturer.	QIAGEN®	RNA isolation
Sample reducing agent (10X)	500 mM DTT at a ready-to-use 10X concentration in a stabilized liquid form.	Invitrogen	SDS-PAGE, RNA-isolation
NuPAGE® Antioxidant reagent	Not disclosed by manufacturer	Invitrogen	SDS-PAGE

**Table 4: Cell line materials**

<b>Material</b>	<b>Content</b>	<b>Manufacturer</b>	<b>Purpose</b>
FBS	Fetal Bovine Serum	Gibco®	Serum-supplement for cell growth
Penicillin-Streptomycin	5000 units/ml of penicillin and 5000 µg/ml of streptomycin.	Gibco®	Prevent bacterial growth in cell cultures.
Growth medium: RPMI-1640	L-glutamine, sodium bicarbonate and phenol red.	SIGMA®	Cell growth
Growth medium: Complete RPMI-1640	RPMI-1640 with 10% FCS and 1× Penicillin/Streptomycin.	SIGMA®	Cell growth
Growth medium: Opti-MEM®	With L-glutamine.	SIGMA®	Cell growth and transfection
Growth medium: Complete Opti-MEM®	Opti-MEM® with 10% FCS and 1× Pen/Strep.	SIGMA®	Cell growth
Trypsin	0.25% Trypsin in PBS, 0.05% Na <sub>2</sub> -EDTA	SIGMA®	Splitting cells

**Table 5: Human cell lines used**

<b>Cell line</b>	<b>Organ</b>	<b>Disease</b>	<b>Reference</b>	<b>Purpose</b>	<b>Media</b>
NCI-H460	Lung	Non-small cell lung cancer (NSCLC) – Adenocarcinoma	ATCC® HTB-177™	Transfection study	RPMI-1640
NCI-H661	Lung	NSCLC – Squamous-cell carcinoma	ATCC® HTB-183™	Transfection study	RPMI-1640

**Table 6: Transfection reagents**

<b>Reagent</b>	<b>Manufacturer</b>	<b>Purpose</b>
Lipofectamine <sup>TM</sup> 2000	Invitrogen Cat. # 11668-019	siRNA-based gene knockdown experiments.
PAX6 siRNA	Ambion Cat. # 4392420	Knock down expression of PAX6.
Scramble (SCR) siRNA	Ambion Cat. # 4404021	siRNA negative control.

**Table 7: qRT-PCR reagents**

<b>Reagent</b>	<b>Manufacturer</b>	<b>Purpose</b>
SYBR green Brilliant II QPCR Master Mix	Agilent	PCR-reaction

**Table 8: qPCR primers**

<b>Gene</b>	<b>Forward primer (5' → 3')</b>	<b>Revers primer (5' → 3')</b>
PAX6	CAACTCCATCAGTTCCAACG	TGGATAATGGGTTCTCTCAAACCTCT
TGFBI	TGAAATCCTGGTTAGCGGAGGCAT	ACGCCATTTGTGGCCATGATGT
VEGFC	AGGCCAACCTCAACTCAAGGACA	CCCGTGGCATGCATTGAGTCTTT
VEGFA	GGTGCCCCAAGCAATACAAGCAT	CACACCTTGCTCCAATGTAGCCT
VEGFD	ATGCAGGCTGAGGCTCAAAAGTT	GGCTGCACTGAGTTCTTTGCCAT
VEGFR1	ACCGAATGCCACCTCCATGTTTG	ATCTTGAGCGAGGCCTTGGGTTT
VEGFR2	ATCTGCCCAGGCTCAGCATACAA	ACCCTTTGCTCACTGCCACTCT
VEGFR3	ACAAGAAAGCGGCTTCAGCTGTA	ACAGCTCCCCATACTCGCTGTT
PDGFA	CGCGACCACAAGCCTGAATCC	TGGTTGGCTGCTTTAGGTGGGT
AKT3-1	CACCTTCCGACATCCCAGACCA	AGCAGCAACAGCATGAGACCTT
AKT3-2	TCTGAGGACCGCACACGTTTCTAT	TGGCTGCATCTGTGATCCCTTCT
PTEN	TGTTCAAGTGGCGGAACCTTGCAAT	CACAGGTAACGGCTGAGGGAACT
WNT2b-1	ATGTTGGATGGCCTTGGAGTGGT	ACGCTGACTGTGTAGGTATGCCA
WNT2b-2	TGTCCGTTTTTGCCAAGGCCTTC	ACTCACGCCATGGCACTTACACT
v-MYC	GCAGCTGCTTAGACGCTGGATTT	AATACGGCTGCACCGAGTCGTAG
EIF4H	TGTGGACATTGCAGAAGGCAGAA	TTGAAGTCATCCCGGGAATCCCA
SFRP2	ACATGCTTGAGTGCGACCGTTT	GCAGGCTTCACATACCTTTGGAG
ANG1	ACACTGGGACAGCAGGAAAACAGA	TTTAGATTGGAGGGGGCCACAAGCA
BMP2	TGTATCGCAGGCACTCAGGTCA	CCGGGTTGTTTTCCCACTCGTTT
MXD1	TTCGCTTGTGCCTGGAGAAGTT	TGGTCGATTTGGTGAACGGCTTT
MAX-1	CGGGCCCAAATCCTAGACAAAGC	TTCTCCAGTGCACGGACTTGCT
MAX-2	ACGAAGAGCAACCGAGGTTTCAA	TGAGTCCCGCAAACCTGTGAAAGC
BTC	GGTGCCCCAAGCAATACAAGCAT	CACACCTTGCTCCAATGTAGCCT
TF1	GGCGCTTCAGGCACTACAA	TTGATTGACGGGTTTGGGTTC
TFPI1	TTGTGCATTCAAGGCGGATGA	TCTTCGCACTGTGAGTGAAA
TNFa	GAGGCCAAGCCCTGGTATG	CGGGCCGATTGATCTCAGC

**Table 9: Antibodies**

<b>Antibody</b>	<b>Dilution</b>	<b>Manufacturer</b>
Mouse anti-PAX6 (Cat# MAB5552)	1:1200	Millipore
Goat anti-DKK3 (Ref: ab2459)	1:3000	Abcam®
Rabbit anti-CTGF (Ref: ab6992)	1:3000	Abcam®
IRDye 800CW Donkey anti-Goat	1:10000	LI-COR®
IRDye 800CW Donkey anti-Mouse	1:1000	LI-COR®
IRDye 800CW Donkey anti-Rabbit	1:10000	LI-COR®

## **Methods**

### **Cell Culture techniques**

To avoid contamination by microorganisms it is very important to use proper aseptic techniques to minimize such contamination. For this reason all cell related work was performed inside a LAF cabinet, class II in a separate cell lab. Gloves and protective coats were always used in the cell lab. Before and after working in the LAF cabinet, the surfaces were cleaned with 70% ethanol. Equipment used in the cabinet was also cleaned with 70% ethanol before use.

### ***Thawing cells***

Complete medium was pre-warmed before selected cells were removed from the liquid nitrogen tank and placed in the incubator. After no more than 10 minutes the cell-suspension was transferred from the cryo-tube to a T-25 culture flask together with 5 ml of pre-warmed complete medium. The media was changed the next day to remove all traces of DMSO (a freezing agent), which can be toxic to the cells.

### ***Trypsination of cells***

When splitting cells for further cell work or sub-cultivation, they need to be trypsinised to detach from the flask surface. Media is removed and cells are washed with 10 ml (for T-75 flask) PBS to remove traces of serum, which contain inhibitors of trypsin. The PBS is removed, and 1 ml trypsin is added and distributed over the surface. The flask is placed in the incubator for optimal reaction temperature for the trypsin. After 5 minutes the flask was checked under a microscope to confirm cell-detachment. If all the cells had not detached, the flask was put back in incubator and checked every two minutes until all cells had detached. Despite various protocols suggesting pounding the flask against the palm of hand to accelerate detachment, we did not utilize this. In our experience this rough treatment of cells caused them to clump, and they hence became difficult to re-suspend. 9 ml of complete media was added to the flask, and distributed over the surface 3-4 times to ensure all cells had detached. The cell suspension was gently pipetted up and down until all clumps had broken up. Cells were typically sub-cultivated in a ratio of 1:10.

### **Transfecting siRNA**

Transfection is a method used to introduce nucleic acids into living cells. In this study Lipofectamine®2000 from Invitrogen was used to get siRNAs (small interfering RNAs) into cells. Lipofectamine is a cationic liposome formulation that binds to the negatively charged nucleic acids, and then fuses through the cell membrane transporting the nucleic acids into the cell[42]. Inside the cell, siRNAs targets and interferes with the expression of genes with complementary sequences. In this study, siRNA targeting PAX6, and its isoforms, was transfected into different cell lines. Scrambled (SCR) siRNA was transfected as negative control. Cells were grown to 50-70% confluence in 6-well dishes before media was removed and replaced with 1 ml of transfection mix per well. The transfection protocol has been thoroughly optimized and the efficiently carefully evaluated.

#### **Transfection mix (1 ml):**

50 µl Opti-MEM

2 µl Lipofectamine®2000

2 µl siRNA

→ Wait 15 minutes

→ Add 1 ml Opti-MEM

In a 6-well dish, 3 wells were transfected with PAX6 siRNA and 3 wells with SCR siRNA. Media was changed after 24 hours, and harvested for total RNA isolation and western blotting (2 wells for WB and 1 well for RNA) 48 hours after transfection start.

### ***Harvesting cells***

Cells were harvested for both RNA-isolation and Western blotting. Cells were typically harvested from a 6-well plate, where 3 wells contained cells transfected with scramble siRNA, and 3 wells contained cells transfected with PAX6 siRNA. For each transfection, 2 wells were harvested for SDS-PAGE and 1 well harvested for RNA-isolation. To wells harvested for SDS-PAGE, 100 µl of LDS sample buffer (see materials) per ~300.000 cells were added, scraped and transferred to a 1.5 ml eppendorf-tube, denatured at 85° C for 5 minutes and stored at -20° C. To cells harvested for RNA-isolation, 345 µl Buffer RLT+10 µl Sample Reducing Agent were mixed before added to each well. The cells were scraped, transferred to a 1.5 ml eppendorf-tube and stored at -70° C pending RNA-isolation.

### **Total RNA isolation**

Total RNA was isolated using the RNeasy Mini Kit® from Qiagen™. The method combines guanidine-isothiocyanate lysis and a RNA-binding silica membrane spin column. For detailed description see manufacturers protocol. In brief, the homogenized cell lysate (cells harvested for RNA-isolation) is transferred to a gDNA (genomic DNA) eliminator spin column and centrifuged for 30 seconds at 11000 rpm. 70% ethanol is added to the flow-through to enhance binding properties. The sample is then transferred to an RNeasy spin column and centrifuged for 15 seconds at 11000 rpm. The flow-through is discarded and the spin column washed 3 times in washing buffer according to the manufacturer's instruction manual. The total RNA is eluted in 30 µl RNase-free water. The total RNA concentration was measured on a NanoDrop® instrument from Saveen Werner™.

### **NanoDrop**

The total RNA concentration and purity was determined using the ND-1000® Spectrophotometer from Saveen Werner™. Before loading the sample, a reference was loaded to "blank" the instrument. The total RNA was eluted in water, so water was used as the reference in this study. 1 µl sample was applied for each measurement, and the concentration was reported in µg/ml. The ratio between wavelengths 260/280 and wavelengths 260/230 gave an indication on the quality of the total RNA.



## **cDNA synthesis**

The total RNA from the RNA isolation was reverse transcribed into its complementary DNA strand (cDNA) by using the SuperScript<sup>®</sup> III Reverse Transcriptase kit from Invitrogen<sup>™</sup>. The cDNA was reverse transcribed using random hexamer primers. The cDNA synthesis was performed in 2 steps:

### **cDNA synthesis – Step 1**

- 1 µg Total RNA
- 20 µM Random hexamer primers
- 1 µM dNTP mix
- Water up to 26 µl

The samples were incubated at 65° C for 5 minutes and then moved on ice for >5 minutes.

### **cDNA synthesis – Step 2**

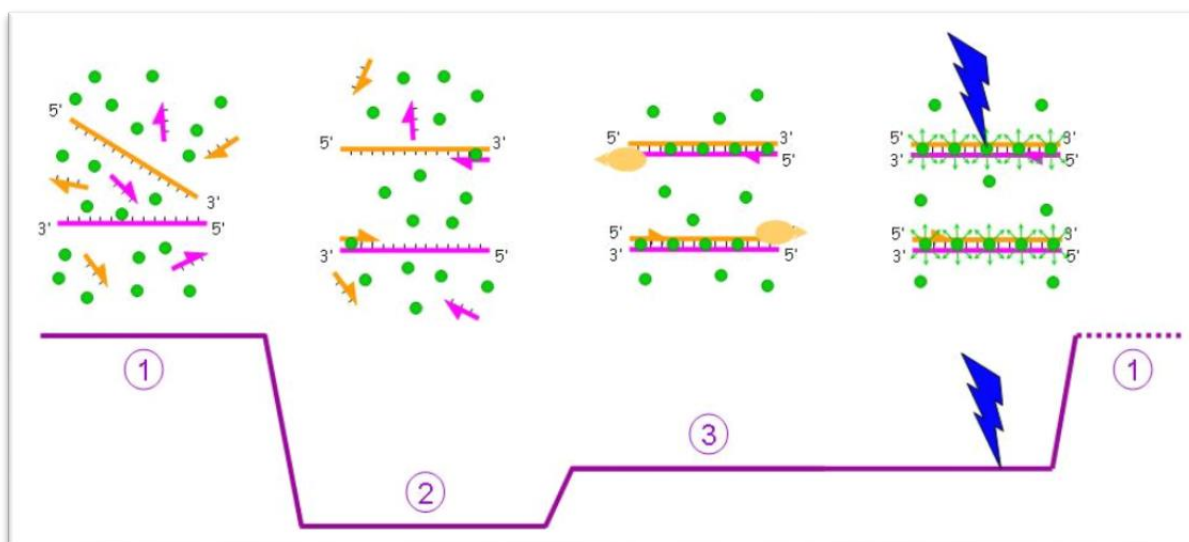
- 8 µl 5X First-Strand buffer
- 2 µl 0.1 M DTT
- 2 µl RNaseOUT<sup>®</sup>
- 2 µl SuperScript<sup>®</sup> III

The samples were incubated at 25° C for 5 minutes and then moved to 50° C for 1 hour. The reaction was inactivated by heating to 70° C for 15 minutes, moved on ice and finally the newly synthesised cDNA was diluted 1:6. The samples were stored at -20° C.

## Quantitative real-time PCR (qPCR)

The quantitative real-time PCR is, in contrast to traditional end-point PCR, both quantitative and qualitative. The principle of qPCR is the same as for traditional PCR, but the amplified sequence is detected in real-time, between each cycle, instead of analysing the product only at the end of the PCR-reaction.

In this study the Brilliant II SYBR<sup>®</sup>Green QPCR Master Mix from Agilent Technologies<sup>™</sup> was used in accordance with the manufacturer's instructions.



**Figure 3: The mechanism for the SYBRGreen dye. During denaturation (1) the dye is not bound to any double strand DNA, and hence the fluorescence is reduced. During annealing (2) and elongation (3), the dye binds to the newly synthesized double stranded DNA, and at this point the fluorescent signal is measured.**

(Source: [http://upload.wikimedia.org/wikipedia/commons/6/6b/PCR\\_with\\_SYBR\\_green.jpg](http://upload.wikimedia.org/wikipedia/commons/6/6b/PCR_with_SYBR_green.jpg))

For the qPCR reaction a 96-well plate was used, with a total of 25  $\mu$ l of reaction mix in each well. For each primer-pair, two technical replicates were made to evade variation. For each plate, a “no template control” (NTC) and a “no reverse transcriptase” (no RT) control were ran. The NTC was the qPCR reagents with template (cDNA) replaced with water, and the no RT control was a prepared product of RNA-to-cDNA reaction ran without reverse transcriptase. The NTC was added to ensure no contamination of the reagents with DNA, and the no RT control was to ensure absence of amplified genomic DNA.

**Table 10: qPCR reaction mix (1 sample)**

Component	Quantity
SYBR <sup>®</sup> Green master mix	12.5 $\mu$ l
Water	9.5 $\mu$ l
Forward primer (10 $\mu$ M)	1 $\mu$ l
Reverse primer (10 $\mu$ M)	1 $\mu$ l
Template (diluted cDNA)	2 $\mu$ l
<b>Total</b>	<b>25 <math>\mu</math>l</b>

The qPCR reaction was run on a Stratagene Mx3000P<sup>®</sup> QPCR System from Agilent Technologies<sup>™</sup>, and the raw data was analysed on the MxPro<sup>™</sup> QPCR software.

**Table 11: Thermal cycler profile**

Step	Temperature	Time	Cycles
Denaturation	95 ° C	10 min	1
Denaturation	95 ° C	15 sec	45
Annealing/elongation	60 ° C	60 sec	

The instrument was set to run 45 cycles, but all  $C_T$  (cycle threshold) values greater than 37 was considered as not detected due to the indicative of minimal amount of target sequences present in the sample. Technical replicates with a  $\Delta C_T$  of more than 1 were also rejected. The  $C_T$ -value for each reaction was automatically set by the software, and the amplification curve for each reaction was controlled to have reached log phase. Relative gene expression (fold change) was determined by using the  $2^{-\Delta\Delta C_T}$  calculation method [43]. To study the relative gene expression, and not do absolute quantification, is preferable in the sense that we wanted only to study the difference in gene expression between a control sample (SCR siRNA) and a PAX6 knock-down sample (PAX6 siRNA). SYBR green was used in the PCR chemistry. SYBR green is much more cost-efficient than TaqMan probes, and for comparative real-time PCR it provides acceptable results. Melting curves were studied to make sure only one product was amplified, and random PCR-product were also ran on gel.

## **Primer design**

Primers were designed using the free software AmpliF<sub>x</sub> 1.6.1. Primers were designed so that the amplicon would cross intron-exon boundaries. This was done to allow easy detection of amplification of genomic DNA if significant genomic contamination occurred. The primers were in addition designed so that the amplicon would be no longer than 150 pb. The purpose of this was to minimize potential effects of degradation of mRNA. For some genes where the genomic maps indicated existence of several transcripts, we designed two primer sets: one to detect exclusively the full length transcript, and one to detect most or all existing transcripts (when possible).

## **SDS-PAGE**

Sodium Dodecyl Sulfate PolyAcrylamide Gel Electrophoresis (SDS-PAGE) is method used to separate proteins based on their molecular mass. SDS is an anionic detergent that denatures the proteins, and gives the proteins a negative charge that is evenly distributed relative to the proteins' mass. This distribution of charge results in the size fractionation during the electrophoresis. In this study, the PowerEase® 500 Power Supply and the XCell SureLock™ Mini-Cell systems from Invitrogen™ were used. There are different types of gels on the market, and in this study the NuPAGE® Bis-Tris gels with a 4-12% gradient from Invitrogen™ was used for the SDS-PAGE. Harvested cell-lysates for SDS-PAGE were loaded (18-25 µl) to the gel, and the gel was run for 40 minutes with a constant current of 200 V. The gel was then immediately prepared for western blot.

## **Western Blot**

Western blotting is a method used to detect specific proteins/peptides in a complex mixture of proteins. The proteins that have been separated during the SDS-PAGE can be analysed with western blot. Proteins are transferred from the gel with an electric current to a nitrocellulose membrane where they are immobilized. The proteins can then be detected by using antibodies that target the proteins of interest, followed by secondary antibodies containing an infra red dye that targets the primary antibodies. In this study, the XCell II™ Blot Module from Invitrogen™ was used to perform the western blot. The membrane was developed in an Odyssey® SA instrument from LI-COR®. Western blots were performed to identify the presence and, relatively, the quantity of various proteins.

We used typically NuPAGE® Novex® 4-12% Bis-Tris Gels with thickness of 1.0 mm - 12 wells each. Before loading into the gel, protein samples were sonicated on ice until viscosity dropped to acceptable levels. The samples were briefly vortexed and briefly spun down. Electrophoresis was

run according to the manufacturer's instructions, usually for 50 minutes. We were adding NuPAGE® Antioxidant reagent (500 ul) into the inner chamber of the electrophoresis system immediately before applying the electric current.

The gel was mounted with a nitrocellulose membrane in the Blot Module, and the module was filled with blotting buffer. The Blot Module was checked for leakage, and placed in the Mini-Cell. The Mini-Cell was then filled 2/3-full with blotting buffer. The blot ran for 2 hours with a constant current of 150 V. The membrane was then rinsed in deionized water and allowed to dry before placed in a 50 ml falcon tube containing 5 ml blocking buffer. The falcon tube was put on a rotator for 1 hour. Primary antibody was diluted to preferred concentration in blocking buffer, and 3 ml were added to the falcon tube after the initial blocking buffer had been thoroughly removed. The membrane was incubated with the primary antibody on a rotator for 2 hours (sometimes overnight at 4° C), before washed 5×5 minutes with 5 ml TBST. Secondary antibody was diluted 1:10000 in blocking buffer and added to the membrane. The membrane was protected from light and incubated with the secondary antibody on a rotator for 1 hour, and then washed 5×5 minutes with 5 ml TBST, followed by a final rinse with TBS. The falcon tube containing the membrane was then filled with TBS, protected from light and brought to the Odyssey® SA instrument for development. The membrane was stored in deionized water, protected from light at 4° C.

### **Real-time monitoring of cells - xCELLigence®**

To study the effects on PAX6 siRNA transfected cells in real-time, the xCELLigence® system from Roche® was used. The xCELLigence system allows for label-free and dynamic monitoring of cellular phenotypic changes in real time using impedance as readout. The system measures electrical impedance across coupled gold micro-electrodes integrated on the bottom of tissue culture plates. The impedance measurement, which is displayed as cell index (CI) value, provides quantitative information about the biological status of the cells, including cell number, viability and morphology. In this study we used E-plates and CIM-plates to study proliferation and migration, respectively.

#### ***E-Plate***

On the E-plate, each individual well incorporates a sensor electrode array that allows cells in the well to be monitored. Each plate contains 16 wells. In the presence of cells, cells attached to the

electrode sensor surfaces act as insulators and thereby alter the local ion environment at the electrode-solution interface, leading to increased impedance. The more cells that grow on the electrodes, the larger the value (CI) gets.

Before cells were seeded into the E-plate, 60  $\mu$ l of media was added to each well. The plate was then placed in the instrument, and the baseline impedance was registered. Then 100  $\mu$ l of cell suspension containing the desired amount of cells were seeded into each well. The plate was left 1 hour outside the instrument allowing cells to precipitate before measurements could start. The CI was recorded each 15 minute for the first 24 hours, and then each 30 minutes for the rest of the run.

### ***CIM-Plate***

In this study, the CIM-plate was used to study cell migration assays on the xCELLigence® RTCA DP instrument. The CIM-Plate contains 16 wells which comprises an upper chamber and a lower chamber. The upper chamber has 16 wells that are sealed at the bottom with a microporous polyethylene terephthalate (PET) membrane containing microfabricated gold electrode arrays on the bottom side of the membrane. The 16 wells of the lower chamber serve as a reservoir for media and any chemoattractant.

Prior to being transferred into CIM-plates, cells were serum-starved for 24 hours. Cells were seeded in desired amount in the upper chamber of the CIM-plate. The bottom chambers of the CIM-plates were filled with serum-containing media (to promote migration across membranes towards the serum gradient), or serum-free media. The CIM-plate was then transferred into the xCelligence for continuous read-outs. Impedance (Cell Index) was registered only from cells capable of migrating through the porous membrane.

### **Real-time monitoring of cells – IncuCyte®**

The IncuCyte® ZOOM instrument from Essen BioScience® allows for live content imaging. In short, this means the acquisition, analysis and quantification of images from live cells that remain unperturbed by the detection method, allowing for repeated measures over longer periods of time.

The instrument consists of an imaging module placed inside a standard 37° C 5% CO<sub>2</sub> incubator, and a powerful data processing unit. The instrument can hold both different types of plates and

different types and sizes of flasks. It can take images in HD phase-contrast, and detect green and red fluorescence.

For this thesis, proliferation studies, migration studies and apoptosis studies were performed on the IncuCyte® ZOOM. 96 well plates were used to study both proliferation and migration. For the proliferation study, 3000-5000 cells per well (depending on cell line), were seeded into a 96 well plate. The plate was placed in the IncuCyte, and the instrument was typically programmed to take two pictures per well with one hour intervals. The proliferation rate was calculated by the instrument software and presented as graphs. For the migration study, 30000-40000 cells per well (depending on cell line), were seeded into a 96 well plate, and placed in a 37° C 5% CO<sub>2</sub> incubator. When cells had attached, a scratch wound was made in each well by using a specialized device provided from the manufacturer. After the wounding, the wells were washed two times with PBS to remove cell debris derived from the wounding. The plate was placed in the IncuCyte, and the instrument was programmed to take two pictures per well with one hour intervals. The migration rate into the wound was calculated by the instrument software and presented as graphs. The apoptosis rate was analysed from the same cells as the proliferation study by adding the Essen CellPlayer™ Caspase-3/7 apoptosis reagent from BioScience®. Stimulation of either the extrinsic or intrinsic apoptotic pathways triggers a signalling cascade that results in the activation of caspases, which in turn cleave substrates following an Asp amino acid residue. When the Caspase-3/7 apoptosis reagent is added to the cell culture growth medium, this inert, non-fluorescent substrate freely crosses the cell membrane where it is cleaved by activated caspase-3/7 resulting in the release of the DNA dye and green fluorescent labelling of DNA, which can be measured by the IncuCyte instrument [48].

## **In-Cell Western™ (ICW)**

ICW is a technique for quantification of intracellular signalling in whole cells. Cells are seeded into 96 well plates and target-specific primary antibodies and infrared-labelled secondary antibodies are used to detect target proteins in fixed and cells. The 96 well plates were analysed on the Odyssey® SA instrument from LI-COR®.

Cells are grown close to confluence in a 96 well plate before media is removed and 150 µl fixation solution containing 3.7% formaldehyde in 1X PBS is added to each well. The plate is incubated for 20 minutes before fixation solution is removed. The cells were permeabilized by washing 5×5 minutes on a rotator in 200 µl Triton washing solution containing 0.1% Triton X-100 in 1X PBS. After the last wash, 150 µl blocking buffer is added, and the plate is incubated for 1.5 hours with moderate shaking. Blocking buffer is then removed and 50 µl of primary antibody diluted in blocking buffer is added to each well. Cells and primary antibody is incubated overnight at 4° C with gentle shaking. Primary antibody is removed and cells are washed in 200 µl 1X PBS containing 0.1% Tween-20 for 5×5 minutes on a rotator. After the last wash, 50 µl of secondary antibody diluted in blocking buffer is added to each well, and the plate is incubated protected from light for 1 hour on a rotator. Cells are then again washed in 200 µl 1X PBS containing 0.1% Tween-20 for 5×5 minutes on a rotator. After the last wash, the PBS is thoroughly removed and the plat is protected from light and brought to the Odyssey® SA instrument for imaging. The plate is stored protected from light at 4° C.

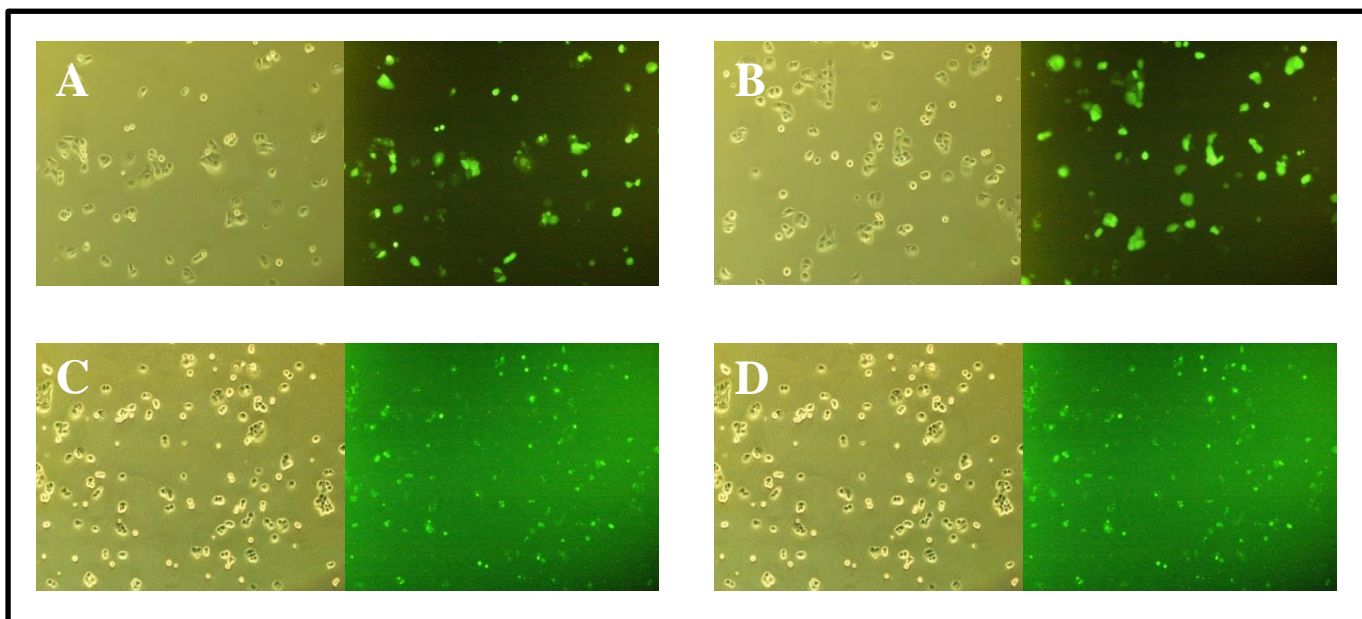


## Results

The main goal of this thesis was to study the molecular and phenotypic effects of the transcription factor PAX6 in lung cancer cell lines. Knock-down of PAX6 expression was achieved by transfecting PAX6 siRNA into cells. Genes and proteins of interest were studied using real-time qPCR and western blotting, respectively. The significance of PAX6 for cells' ability to proliferate, migrate and undergo/evade apoptosis was studied using two systems for real-time monitoring of cells in culture.

### Transfection of PAX6 siRNA and SCR siRNA

The lung cancer cell lines NCI-H460 and NCI-H661 were transfected with PAX6 siRNA and scrambled (SCR) siRNA in this study. To determine the efficiency of the transfection, a plasmid encoding Green Fluorescent Protein (GFP) was co-transfected in the initial transfections. Cells would emit green fluorescence if plasmids encoding the GFP had been successfully transfected and the protein was expressed. Amount cells expressing green fluorescence compared to the amount of non-expressing cells, gave an estimate of the overall transfection efficiency. Figure 4 show PAX6 siRNA and SCR siRNA transfected cells, co-transfected with GFP. The field of view is the same in the brightfield photo as for the fluorescence photo. This allows for direct comparison between the two pictures.



**Figure 4: Co-transfection of a plasmid encoding the GFP was used to determine the transfection efficiency.**  
A) H661 SCR siRNA+GFP. B) H661 PAX6 siRNA+GFP. C) H460 SCR siRNA+GFP. D) H460 PAX6 siRNA+GFP.

As figure 4 shows, most cells emit green signal. The fluorescence signal is somewhat weaker in the H460 cells compared with the H661 cells, which is probably due to the fact that these cells are smaller, and thus the transfected amount will be less. The transfection efficiency is >70% for both cell lines and for both siRNAs, which is considered acceptable.

## Real-Time PCR (qPCR)

To study potential regulation of putative and known target genes, qPCR was performed on a number of genes selected for their association with cancer. For each cell line, a minimum of three biological replicates were analysed. In accordance to the  $2^{-\Delta\Delta C_T}$  calculation method, a fold change of 1 (or -1) is equal to no regulation of the target gene [43]. An average fold change  $<1 \geq 0 \leq -1$  indicates significant variations between biological replicates, and is not considered valid data. The results from the qPCR are presented in table 9 and table 10 for the cell lines NCI-H661 and NCI-H460, respectively.

**Table 12: qPCR results for selected genes in H661 cells transfected with PAX6 siRNA.** Values for PAX6 indicate level of knock-down in cells transfected with PAX6 siRNA. Genes highlighted in green show similar regulation patterns between three to four biological replicates.

Gene	Fold change				Statistics				Regulation
	Exp.1	Exp.2	Exp.3	Exp.4	Average	SD	CV (%)	Range	
AKT3-1	1.1	-1.1	1.4	1.2	0.6	1.2	187.2	2.5	
AKT3-2	1.1	-1.1	1.4	1.4	0.7	1.2	165.2	2.5	
ANG1	-1.1	1.1	1.4	-1.1	0.1	1.4	1974.2	2.5	
CTGF-1	1.7	1.2	2.1	1.5	1.6	0.4	23.7	0.9	Downregulated by PAX6
CTGF-3	1.5	1.1	1.9	1.4	1.4	0.3	22.8	0.8	Downregulated by PAX6
DKK3	1.4	1.3	1.3	1.4	1.3	0.1	4.6	0.1	Downregulated by PAX6
P53	-2.1	-	-1.4	-1.0	-1.5	0.4	28.8	1.1	Upregulated by PAX6
<b>PAX6</b>	<b>-10.0</b>	<b>-15.1</b>	<b>-5.9</b>	<b>-4.6</b>					
PDGFB	-1.1	-1.0	1.2	1.5	0.2	1.4	896.6	2.5	
PTEN	-1.7	-1.8	-1.4	-1.4	-1.6	0.2	13.9	0.5	Upregulated by PAX6
TF1	-	1.1	1.9	1.8	1.6	0.4	26.7	0.8	Downregulated by PAX6
TFPI1	-1.2	-1.1	1.0	1.0	-0.1	1.3	2012.0	2.2	
TGFB1	1.5	1.1	1.4	1.3	1.3	0.2	12.5	0.4	Downregulated by PAX6
TGFBI	-1.2	1.1	-1.6	-1.2	-0.7	1.2	173.9	2.7	
VEGFA	-1.3	-1.1	1.5	1.0	0.0	1.4	4610.8	2.8	
VEGFC	-1.9	-1.0	-1.0	1.1	-0.7	1.3	178.5	3.0	
VEGFD	-3.2	-2.6	-1.9	-2.2	-2.4	0.6	23.1	1.3	Upregulated by PAX6
VEGFR1	-1.0	-1.3	-1.2	-1.6	-1.3	0.2	17.4	0.5	Upregulated by PAX6
VEGFR2	-1.2	-1.3	1.3	-1.2	-0.6	1.3	213.8	2.6	
VEGFR3	-	1.3	1.5	1.4	1.4	0.1	6.2	0.2	Downregulated by PAX6
BMP2	1.1	-1.0	1.2	-	0.4	1.3	294.0	2.2	
EIF4H-1	-1.7	-1.9	-2.4	-	-2.0	0.3	16.4	0.6	Upregulated by PAX6
EIF4H-2	-1.7	-1.0	-1.4	-	-1.4	0.3	22.9	0.6	Upregulated by PAX6
SFRP1	1.3	-1.2	-1.4	-	-0.4	1.5	339.3	2.7	
SFRP2	-1.9	-2.0	-2.2	-	-2.0	0.1	5.5	0.2	Upregulated by PAX6
v-MYC	1.6	1.5	1.4	-	1.5	0.1	8.8	0.3	Downregulated by PAX6
WNT2b-1	-2.2	-1.4	1.3	-	-0.8	1.8	237.3	3.5	
WNT2b-2	1.6	-1.2	1.5	-	0.7	1.6	242.9	2.8	

**Table 13: qPCR results for selected genes in H460 cells transfected with PAX6 siRNA.** Values for PAX6 indicate level of knock-down in cells transfected with PAX6 siRNA. Genes highlighted in green show similar regulation patterns between three to four biological replicates.

Gene	Fold change					Statistics				Regulation	
	Exp.1	Exp.2	Exp.3	Exp.4	Exp.5	Average	SD	CV (%)	Range		
AKT3-1	1.1	1.3	1.1	1.2	1.1	1.2	0.1	8.5	0.3	Downregulated by PAX6	
AKT3-2	1.2	1.3	1.3	1.0	1.1	1.2	0.1	11.6	0.3		
ANG1	1.3	1.4	1.5	-1.1	-1.5	0.3	1.5	455.1	3.0		
CAV1	1.6	1.6	-	1.3	1.0	1.4	0.3	19.2	0.6		
CTGF-1	1.0	1.0	-1.4	-1.3	1.5	0.2	1.4	787.1	2.9		
CTGF-3	1.0	1.0	1.1	-1.1	1.8	0.8	1.1	143.0	2.9		
DKK3	1.5	2.9	-	-1.0	-1.1	0.6	2.0	342.4	4.0		
P53	1.8	1.7	3.5	-1.6 <sup>1</sup>	1.3	1.4	1.9	137.5	5.1		Downregulated by PAX6
<b>PAX6</b>	<b>-1.9</b>	<b>-2.0</b>	<b>-5.1</b>	<b>-2.9</b>	<b>-6.4</b>						
PDGFB	-1.0	-1.2	-1.0	-	-	-1.1	0.1	10.6	0.0		Upregulated by PAX6
PTEN	-1.0	-1.4	-1.3	1.1	-1.0	-0.7	1.0	140.6	2.5		
TF1	1.6	1.3	-	1.1	-1.1	0.7	1.2	174.6	2.7		
TFPI1	1.1	1.1	-	-1.3	-1.2	-0.1	1.3	1502.5	2.4		
TGFB1	1.0	1.2	1.5	1.1	1.2	1.2	0.2	13.0	0.4		
TGFB1	1.2	1.1	-1.3	1.0	1.1	0.6	1.1	167.8	2.4		
TNFa	-1.5	-1.0	-	1.2	-	-0.4	1.5	330.9	2.8		
VEGFA	1.0	1.3	-1.4	1.1	1.3	0.7	1.2	175.8	2.7		
VEGFC	-1.3	1.1	-1.5	-1.0	1.4	-0.3	1.4	514.0	2.8		
VEGFD	1.3	1.2	-1.1	1.1	1.5	0.8	1.1	134.0	2.6		
VEGFR1	-1.0	-1.8	1.7	-	-	-0.4	1.9	478.4	3.6		
VEGFR2	-1.4	-1.1	-1.9	-1.1	-2.3	-1.6	0.5	33.7	1.2	Upregulated by PAX6	
VEGFR3	1.1	1.7	1.3	-	1.9	1.5	0.3	23.0	0.8	Downregulated by PAX6	
BMP2	-	-	-2.7	-1.1	1.1	-0.9	1.9	207.0	3.8	Upregulated by PAX6	
BTC	-	-	-1.4	1.4	1.1	0.4	1.6	421.8	2.8		
MAX-1	-	-	1.3	1.3	-1.2	0.5	1.4	301.0	2.5		
MAX-2	-	-	1.4	-1.0	-1.3	-0.3	1.5	477.0	2.7		
MXD-1	-	-	-2.0	-1.1	-1.5	-1.5	0.4	27.5	0.8		
v-MYC	-	-	-1.4	1.1	-1.2	-0.5	1.4	298.7	2.5		
WNT2b-1	-	-	1.7	1.6	2.0	1.8	0.2	13.1	0.5		Downregulated by PAX6
WNT2b-2	-	-	1.5	1.6	1.0	1.4	0.3	21.1	0.5		Downregulated by PAX6

<sup>1</sup> This value is not in accordance with the other biological replicates for P53, hence the large SD and CV compared with other genes of interest (marked in green). P53 is still, however, considered a possible target for regulation due to the fact that 4 out of 5 biological replicates indicate regulation in the same direction.

The results from the qPCR imply that several genes may be regulated, directly or indirectly, by the transcriptions factor PAX6. Table 11 and 12 lists these potential genes with a short description of their function/association.

**Table 14: Genes that show regulation by PAX6 in the cell line H661.**

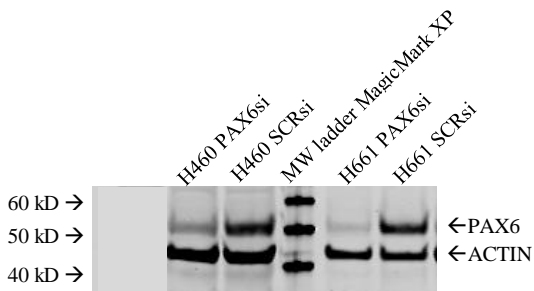
Gene	Fold change				Statistics				Regulation	Function
	Exp.1	Exp.2	Exp.3	Exp.4	Average	SD	CV (%)	Range		
CTGF	1.7	1.2	2.1	1.5	1.6	0.4	23.7	0.9	Downregulated by PAX6	Adhesion, migration, proliferation, angiogenesis,
DKK3	1.4	1.3	1.3	1.4	1.3	0.1	4.6	0.1	Downregulated by PAX6	Wnt signalling (-)
<b>PAX6</b>	<b>-10.0</b>	<b>-15.1</b>	<b>-5.9</b>	<b>-4.6</b>						
TGFB1	1.5	1.1	1.4	1.3	1.3	0.2	12.5	0.4	Downregulated by PAX6	Growth factor
VEGFD	-3.2	-2.6	-1.9	-2.2	-2.4	0.6	23.1	1.3	Upregulated by PAX6	Angiogenesis
PTEN	-1.7	-1.8	-1.4	-1.4	-1.6	0.2	13.9	0.5	Upregulated by PAX6	Tumor suppressor
VEGFR1	-1.0	-1.3	-1.2	-1.6	-1.3	0.2	17.4	0.5	Upregulated by PAX6	Angiogenesis
VEGFR3	-	1.3	1.5	1.4	1.4	0.1	6.2	0.2	Downregulated by PAX6	Angiogenesis
EIF4H-1	-1.7	-1.9	-2.4	-	-2.0	0.3	16.4	0.6	Upregulated by PAX6	Initiation factor
EIF4H-2	-1.7	-1.0	-1.4	-	-1.4	0.3	22.9	0.6	Upregulated by PAX6	Initiation factor
SFRP2	-1.9	-2.0	-2.2	-	-2.0	0.1	5.5	0.2	Upregulated by PAX6	Wnt signalling (-)
v-MYC	1.6	1.5	1.4	-	1.5	0.1	8.8	0.3	Downregulated by PAX6	TF/Oncogene

**Table 15: Genes that show regulation by PAX6 in the cell line H460.**

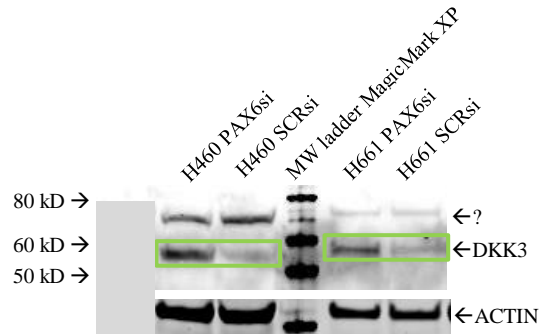
Gene	Fold change					Statistics				Regulation	Function
	Exp.1	Exp.2	Exp.3	Exp.4	Exp.5	Average	SD	CV (%)	Range		
CAV1	1.6	1.6	-	1.3	1.0	1.4	0.3	19.2	0.6	Downregulated by PAX6	Tumor suppressor
P53	1.8	1.7	3.5	-1.6	1.3	1.4	1.9	137.5	5.1	Downregulated by PAX6	Tumor suppressor
<b>PAX6</b>	<b>-1.9</b>	<b>-2.0</b>	<b>-5.1</b>	<b>-2.9</b>	<b>-6.4</b>						
VEGFR2	-1.4	-1.1	-1.9	-1.1	-2.3	-1.6	0.5	33.7	1.2	Upregulated by PAX6	Angiogenesis
VEGFR3	1.1	1.7	1.3	-	1.9	1.5	0.3	23.0	0.8	Downregulated by PAX6	Angiogenesis
WNT2b	-	-	1.7	1.6	2.0	1.8	0.2	13.1	0.5	Downregulated by PAX6	Wnt signalling (+)

## Western blot

Genes that showed potential regulation by use of qPCR were next analysed on western blots for visualisation of changes in protein level. For most of the target genes, however, antibodies against the corresponding proteins were not available or had bad quality, which left the following set of protein to be identified: Anti-PAX6, anti-DKK3, anti-ANG3, anti-CTGF and anti-actin.

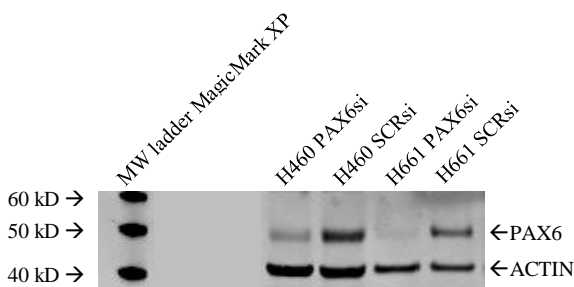


**Figure 5: PAX6 + ACTIN.** Both cell lines show knock-down of PAX6 on protein level.

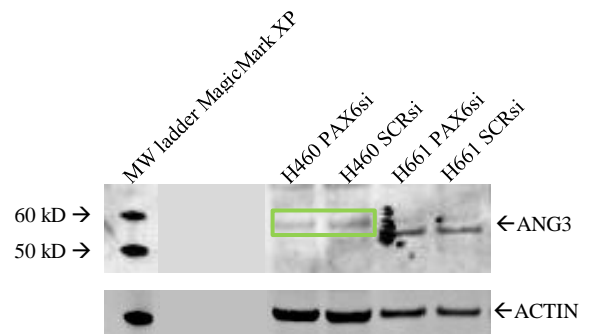


**Figure 6: DKK3.** The knock-down of PAX6 results in an up regulation of DKK3 in both H460 and H661. Around 70 kD there are some unspecific antibody-binding.

DKK3 appears to be upregulated in the PAX6 knock-down sample (figure 6). This correlates well with the data from the qPCR analysis for H661, which suggests that gene expression of DKK3 is downregulated by the presence of PAX6 (table 14).

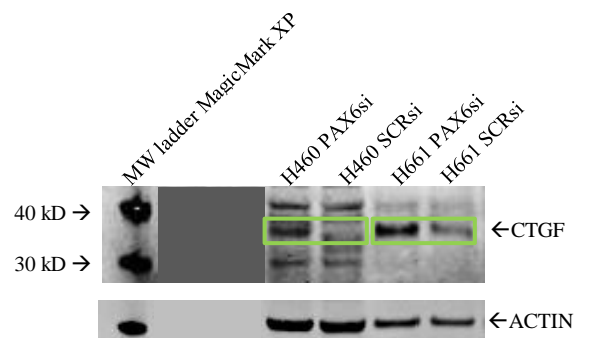


**Figure 7: 20120514A: PAX6 + ACTIN.** Knock-down of PAX6 is evident in both cell lines.



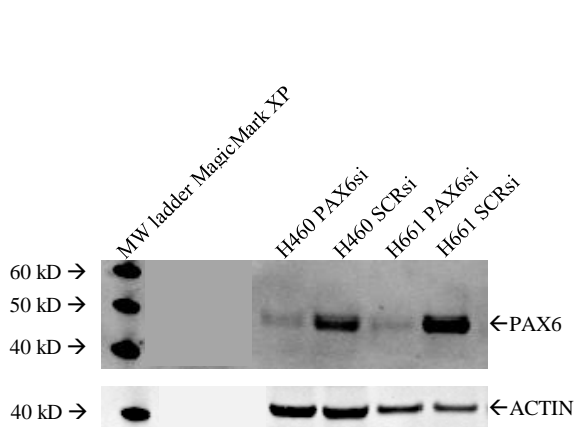
**Figure 8: 20120514A: ANG3.** The knock-down of PAX6 may seem to down regulate ANG3, but the difference is very subtle.

The knock-down of PAX6 seem, in a very subtle way, to down regulate the expression of ANG3 (figure 8). Because this difference is so miniscule, caution should be taken in interpreting these results. CTGF appears to be downregulated for both cell lines by the presence of

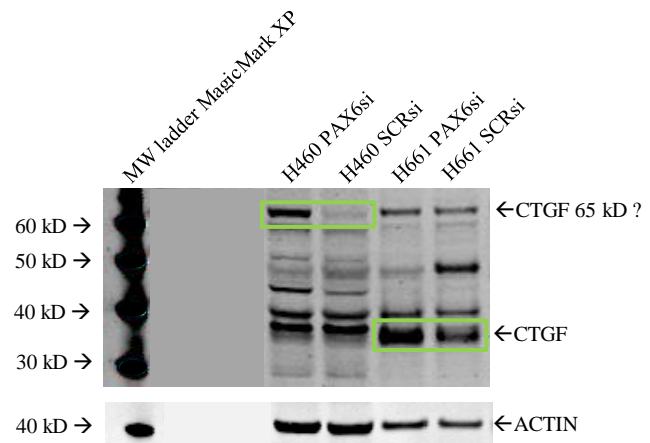


**Figure 9: 20120514B: CTGF.** The knock-down of PAX6 results in an up regulation of CTGF in both cell lines, most notably in H460.

PAX6 (figure 9). This is in accordance with the H661 data from the qPCR, which suggests that gene expression of CTGF is downregulated by PAX6 (table 14). The downregulation of CTGF by PAX6 is opposite of what is reported in a recent study (Kiselev et al., 2012).



**Figure 10: 20120529A: PAX6.** Both cell lines show knock-down of PAX6 on protein level.



**Figure 11: 20120529A: CTGF.** The knock-down of PAX6 results in an up regulation of CTGF in both cell lines. The CTGF protein in the H460 cell line is suspected to be heavily glycosylated, hence its increased molecular weight. Binding between 40kD and 50kD are leftovers from PAX6 antibody from figure 10.

The blot in figure 11 shows the same down regulation of CTGF by PAX6 as the blot in figure 9, again confirming the qPCR results for the H661 cell line. In the H460 cell line (figure 11), the CTGF protein is suspected of being subject for post-translational modification (glycosylation?), resulting in a protein with a molecular weight of 65 kD. This modification was not, however, observed in the experiment represented in figure 9. This will be discussed later.

## Real-time monitoring of cells - xCELLigence®

The lung cancer cell lines H460 and H661 ability to proliferate and migrate after the knock-down of PAX6, was assessed in real-time using the xCELLigence system from Roche. For the proliferation study, typically 3000-4000 cells were seeded in each well in an E-plate. For the migration study, 40000-50000 cells were seeded in each well in a CIM-plate. The plates were mounted in the instrument, and the impedance (cell index) was set to be measured every 15 minute for the first 3 hours, and then every 30 minute for the rest of the run, which varied between 30 hours and 150 hours. The results are presented as graphs showing cell index on the x-axis and time in hours on the y-axis.

### Proliferation study

The proliferation study was performed in a 16-well E-plate.

The graphs show the proliferation rate, with the time (in hours) on the x-axis and the cell index on the y-axis. One should be aware of that, to provide optimal visualisation, the four graphs (figure 12 and 13) do not have the same scaling on either axis. For the experiments presented in figure 15 and figure 17 the same trend is observed - that PAX6 seems to have a positive effect on proliferation. For the experiment in figure 20, media was changed after ~20 hours. This caused a disturbance in the cell index, and the graphs were normalized at ~24 hours to compensate for this.

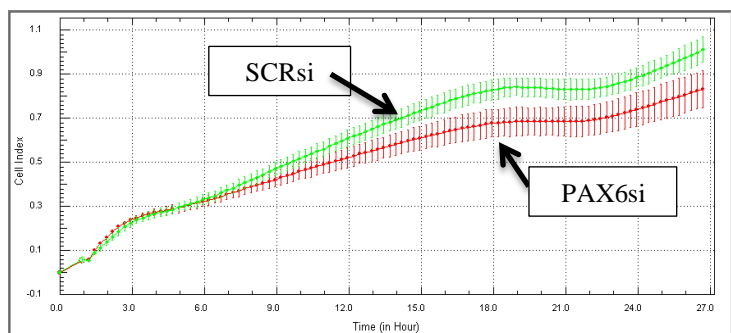


Figure 12: Proliferation study. PAX6 promotes proliferation in H460.

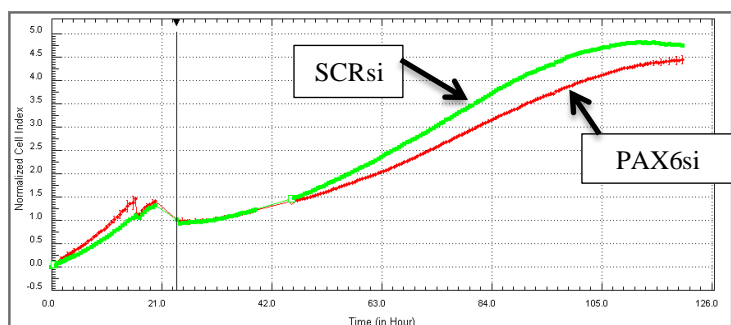
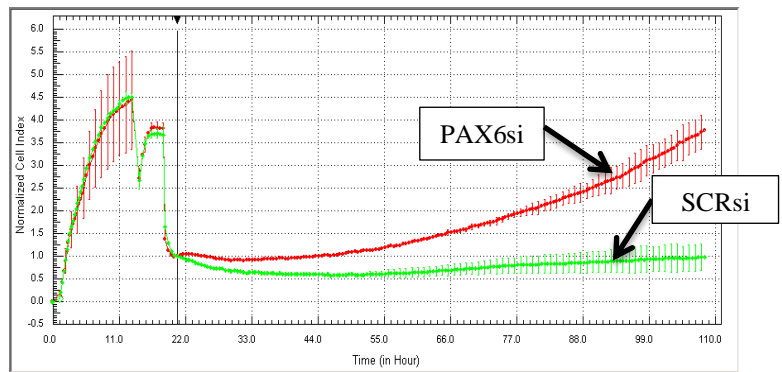


Figure 13: Proliferation study. PAX6 promotes proliferation in H460.



Figure 14 shows the proliferation rate for the only experiment with the H661 cell line that gave any plausible results. Media was changed after ~20 hours, which caused a major disturbance in cell index, and the graphs were normalized to try and compensate for this. The experiment suggests that

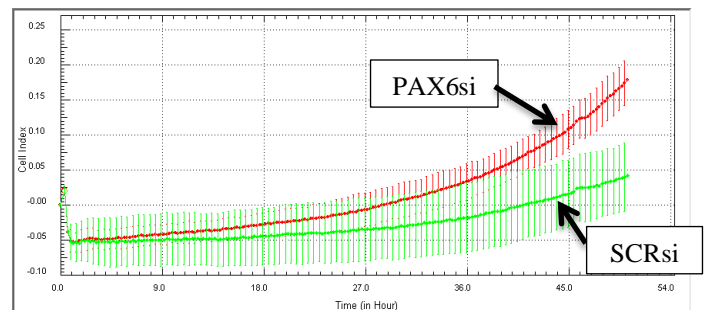


**Figure 14: Proliferation study. PAX6 inhibits proliferation in H661.**

PAX6 has a negative effect on proliferation in the H661 lung cancer cell line. The cells transfected with SCR siRNA show indication of cell death after media change, and only has a slight indication of regained proliferation after ~50 hours.

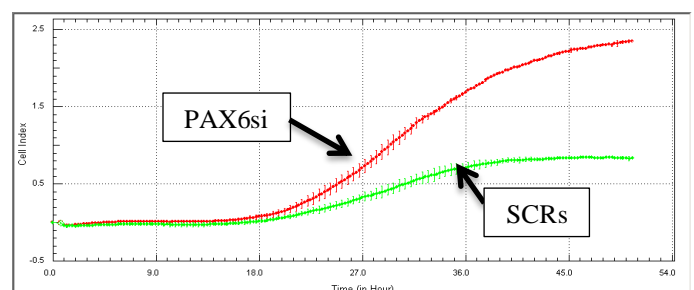
### Migration study

The migration study was performed in a 16-well CIM-plate as described in materials and methods. Cells were seeded in 6-well dishes, transfected for four hours, grown for 48 hours (including the serum starvation period), harvested and seeded in the CIM-plate.

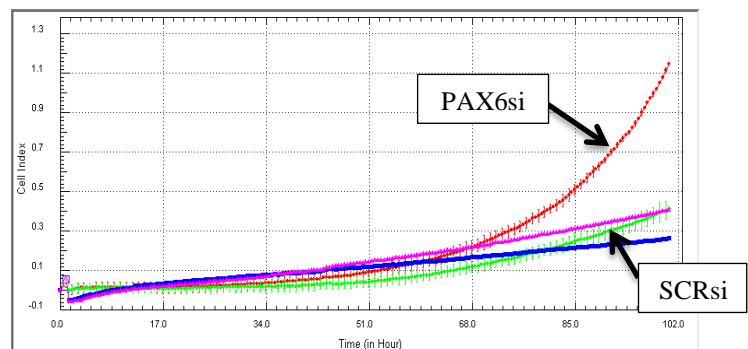


**Figure 15: Migration study. PAX6 inhibits migration in H661.**

The graphs show the migration rate, with the time (hours) on the x-axis and the cell index on the y-axis. One should be aware that the three graphs (figure 15-17) do not have the same scaling on either axis. Figure 15 and figure 16 show the results from experiments with the H661 cell line, and figure 17 the results from the H460 cell line. All three experiments suggest that PAX6 is inhibiting migration of these cell lines. For the H661 cell line the migration is apparent approximately 50 hours earlier then for the H460 cell line. The purple and blue graphs in figure 17 represents PAX6si and SCRsi transfected cells,



**Figure 16: Migration study. PAX6 inhibits migration in H661.**



**Figure 17: Migration study. PAX6 inhibits migration in H460. Purple and blue graphs show PAX6si and SCRsi transfected cells, respectively, with serum free media in lower chamber.**

respectively, with serum free media in the lower chambers. This indicates that neither PAX6si transfected nor SCRsi transfected cells will migrate without serum as an attractant in the lower chamber.

### Real-time monitoring of cells – IncuCyte®

The lung cancer cell lines H460 and H661 ability to proliferate and migrate was also studied in the IncuCyte® ZOOM instrument from Essen BioScience. Apoptosis was also monitored, using the Kinetic Caspase-3/7 Apoptosis Assay from Essen BioScience. Cells were seeded in 96-well plates. For the proliferation study and apoptosis study, typically 4000 cells were seeded in each well, and for the migration study, 30000 cells were seeded in each well. For all studies, the instrument was programmed to take two pictures from each well every hour.

### Proliferation study

Cells were seeded in the wells, allowed to attach to the well surface, transfected for four hours, and placed in the instrument for real-time monitoring.

For this method, proliferation results are only available for experiments done with the H460 cell line. Several other siRNAs were studied on the same plate, hence the many graphs, but these will not be addressed in this thesis. In both experiments (figure 18 and 19), PAX6 appears to have a positive effect on proliferation. This is the same trend as observed for the xCelligence experiments presented in figure 12 and 13.

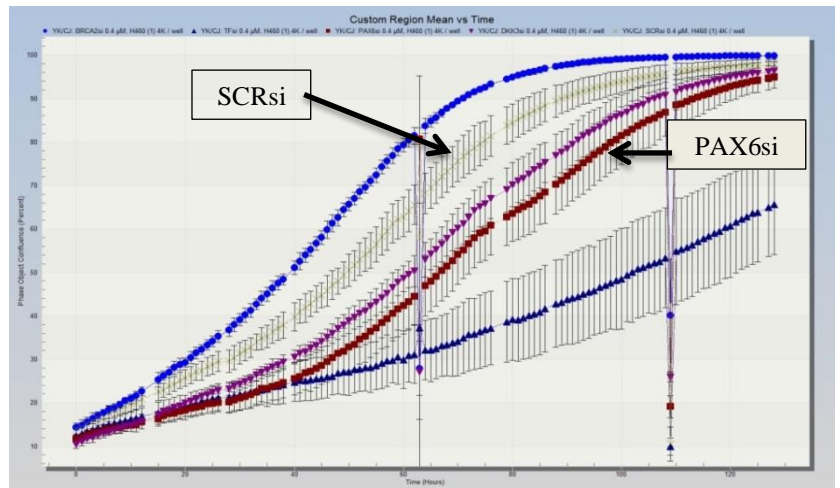


Figure 18: Proliferation study. PAX6 promotes proliferation of H460.

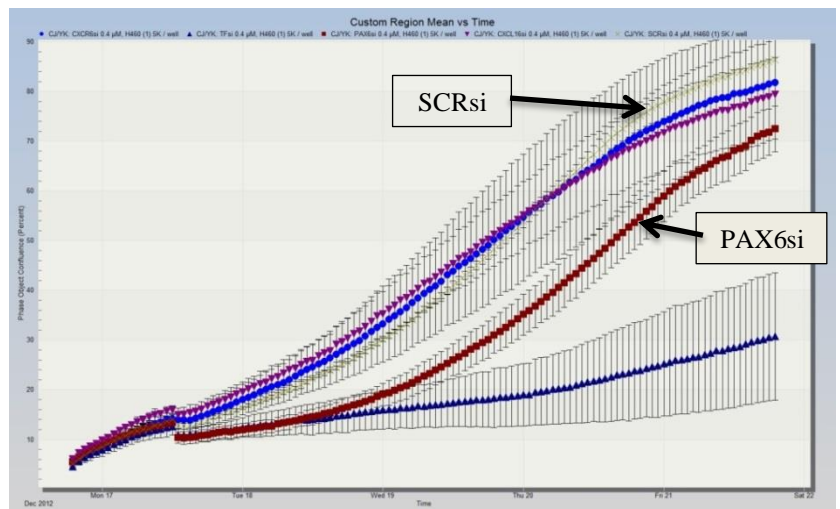


Figure 19: Proliferation study. PAX6 promotes proliferation of H460.

## Migration study

The migration study was performed in a 96-well plate. Cells were seeded in 96-well plates, transfected for four hours and placed in the instrument. Cells were allowed to grow close to confluent before a scratch wound was made as described in materials and methods.

For the migration study, only one result from NCI-H661 has been obtained due to very limited availability of the instrument. No results from the NCI-H460 cell line was obtained for this method. The results from the migration study (figure 20) indicate that PAX6 might have a negative effect on migration. This is the same trend as is observed for the real-time monitoring using the xCellingence system.

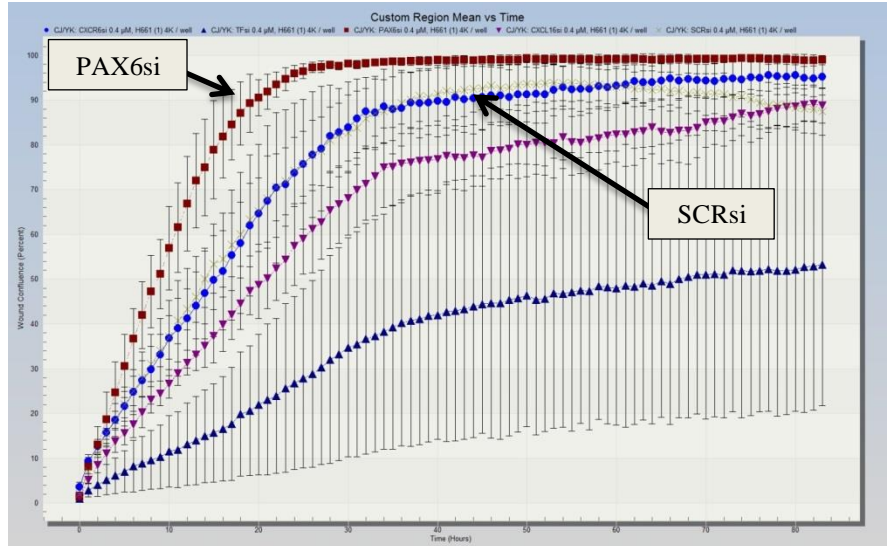


Figure 20: Migration study. PAX6 inhibits migration of H661.

## Apoptosis study

The apoptosis study was performed in a 96-well plate. Cells were seeded in 96-well plates, transfected for four hours before media was changed and the Caspase-3/7 reagent added. The plate was placed in the instrument and two fluorescence pictures per well was taken every hour.

For the apoptosis study (figure 21 and 22), one experiment for each cell line was performed. In the presence of apoptosis, caspase will react with the Caspase-3/7 reagent and emit green fluorescent signal which is detected by the instrument. The x-axis show green fluorescent signal-count and the y-axis shows time in hours. For both cell lines, PAX6 appears to protect the cells from entering apoptosis. For the NCI-H460 cell line, the effect is apparent after ~100 hours, when cells are close to confluent. For the NCI-H661 cell line the affect becomes significant after close to 30 hours, when cells are approximately 50% confluent.

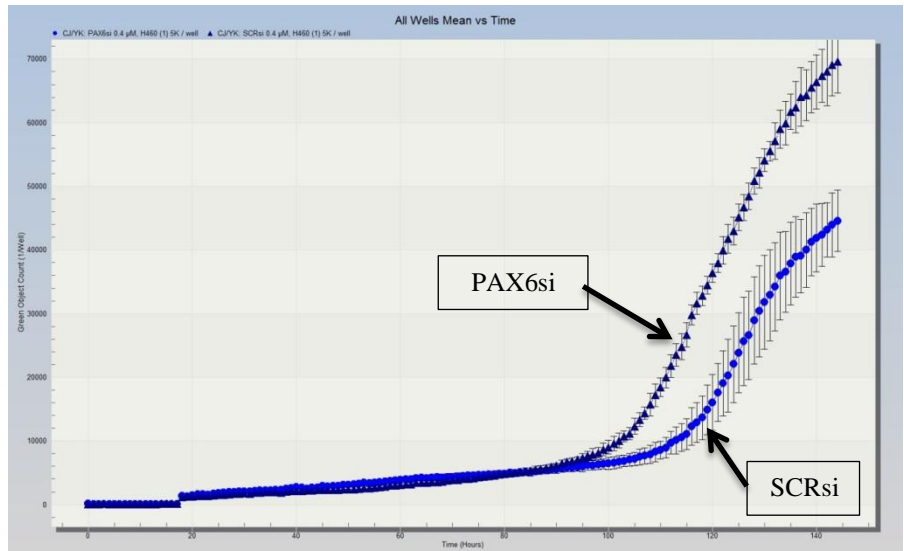


Figure 21: Apoptosis study. PAX6 protects against apoptosis in H460.

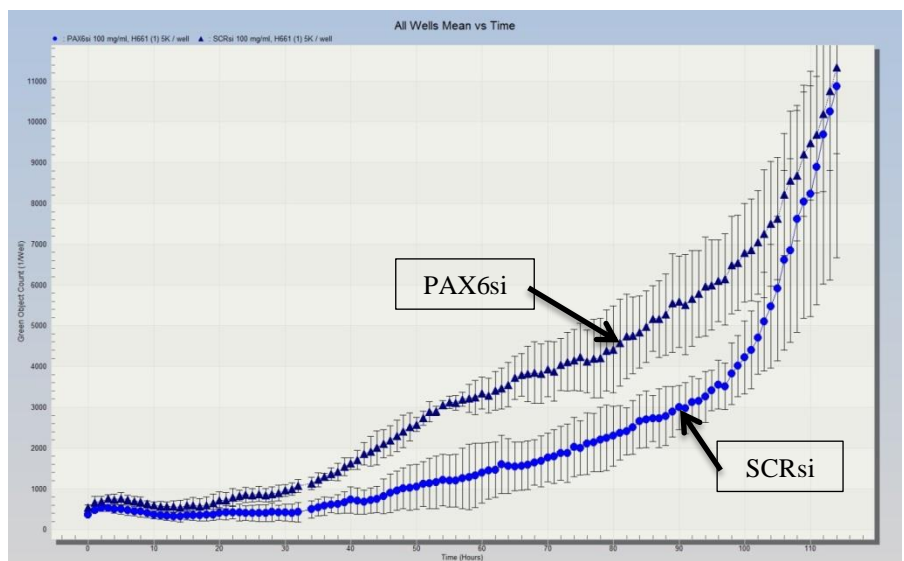


Figure 22: Apoptosis study. PAX6 protects against apoptosis in H661.

## Discussion

The aim of this thesis was to identify novel cancer-associated target genes for PAX6 by studying the effects of the knockdown of PAX6 expression lung cancer cell lines with endogenous PAX6 expression, as well as to study the possible effect this knockdown have on proliferation, migration and apoptosis. Methods used for this purpose were primarily comparative real-time PCR, western blotting, and two different methods for real-time monitoring of living cells.

The cell lines used for this thesis were the lung cancer cell lines NCI-H460 and NCI-H661. The NCI-H460 is an adenocarcinoma cell line that originates from the pleural effusion, while the NCI-H661 is a squamous-cell carcinoma cell line derived from a metastatic site (lymph node). Both cell lines are from the NSCLC family and both demonstrate endogenous expression of PAX6. These two cell lines were both transfected with PAX6 siRNA and SCR (control) siRNA for the purpose of studying the effect on PAX6 knockdown. The initially strategy was to also include cell lines not showing endogenous expression of PAX6, and to transfect these cells with a plasmids containing PAX6 and PAX6(5a). The cell lines intended for this were the non-small cell lung cancer cell lines NCI-H520 and NCI-A549, but the low transfection efficiency observed for both these cell lines rendered them not suitable. Both PAX6-negative cell lines have previously been successively used in transfection experiments, making the nature of the plasmid and/or the chosen transfection reagents a likely cause for the unsatisfactory results. It would have been interesting to compare endogenous PAX6 expression with exogenous PAX6 expression to obtain an even deeper understanding of the effects of PAX6 in lung cancer, and the optimization of PAX6-plasmid transfection into PAX6-negative lung cancer cell lines should be a priority in future studies.

Genes to be studied were selected prior to the initiation of this thesis, and they were pre-chosen on the background of previously described cancer associated target genes of PAX6, molecular/clinical data on NSCLC and available antibodies. In addition, a number of genes known to have effect on angiogenesis were chosen, due to the fact that many non-small cell lung cancers show both increased angiogenic activity and increased expression of angiogenic-associated genes. For each gene, a primer-pair was designed in a way that the amplicon would overlap exon-intron boundaries. This was done to prevent amplification of genomic DNA.

## Comparative qPCR

The results from the comparative qPCR suggest a number of genes as possible targets for PAX6, and these genes are listed in table 14 and 15. Interestingly, only one gene shows regulation in both cell lines on mRNA level. The reason for this lack of consistency in the expression signature between the two cell lines may be attributed to the fact that the regulatory properties of PAX6 are dose-dependent, and hence may not regulate the same set of genes or in the same direction in cell lines with different levels of endogenous PAX6 expression. As well, these two cell lines originate from very different types of NSCLC tumours, therefore the biomolecular context in them differs greatly, providing additional explanation for the observed differences in PAX6-regulated gene sets. In general, living cells are highly dynamic and biological system, and in this aspect one should bear in mind that PAX6 may not necessarily be the direct regulator of the implicated genes in this study, as it may also interact with many of the other pathways.

The one gene that shows regulation by PAX6 in both cell lines is VEGFR3, and in both cell lines this gene appears to be downregulated by PAX6. The VEGFR-proteins are tyrosine kinase receptors for the VEGFs, and they are important signalling molecules in angiogenesis. The VEGFD is associated with binding to the VEGFR3, and in the H661 cell line this gene appears to be upregulated by PAX6. The downregulation of a receptor together with the upregulation of its corresponding ligand, presents a paradox. It could be reasonable to speculate that VEGFD is in fact not regulated by PAX6, but instead is involved in a negative-feedback pathway, not affected by PAX6, to compensate for the loss of VEGFR3. In the H460 cell line, the VEGFR2 is indicated as upregulated. VEGFR2 appears to mediate almost all of the known cellular responses to [44], and one could also in this case make the speculation that a negative-feedback loop is involved. Assuming VEGFR3 is regulated by PAX6, on the basis of it showing regulation in both cell lines, VEGFR2 would in the H460 cell line be the gene regulated via negative-feedback. The DKK3 protein and the SFRP2 protein are both antagonists in the Wnt signalling pathway, and in the H661 cell line, these genes show opposite regulation patterns. Table 14 and 15 lists the rest of the genes with a short description of their cancer-associated function.

Table 12 and 13 shows there is a large variations in fold-change between biological replicates. Most of this variation is probably due to the difficulties presented in producing comparable replicates. The transfection efficiency, cell density, cell passage number and the fact that this is a biological system, are all factors that potentially contribute to variation. The quality of the isolated RNA is

another factor that could have influence on the qPCR results. All the primer-pairs designed for this study produced amplicons not bigger than 150 bp, and because of this the RNA Integrity Number (RIN) was not measured. In addition, for the cDNA synthesis, only random hexamer primers were used. To have used random hexamer primers together with anchored oligo-dT primers would have been optimal. Anchored oligo-dT primers are specifically designed for synthesising long cDNAs from mRNAs carrying poly-A tails. Since this primer only anneals to the poly-A tail junction of the mRNA template, it eliminates transcription through the poly-A tail, providing more effective cDNA synthesis. These two modifications to the method could have yielded better/more consistent results from the qPCR analyses, and in future experiments they should be implemented. An unfortunate coincidence for the majority of the studied genes was their low expression on mRNA level. This resulted in very late Ct-values, and therefor increasing between-sample variations.

## **Western blot**

The result from the western blots confirms knockdown of PAX6 on protein level for both cell lines. There are only a limited number of successful blots available due to several reasons. Ideally, one would like to show western blots for all the proteins that show regulation on gene-level, but unfortunately this was not achieved. Antibodies were not available for many corresponding proteins, and several of the antibodies applied yielded unacceptable results. Some antibodies did not show any protein affinity, whilst other antibodies showed very high levels of unspecific binding.

We were able to show regulation on protein level for CTGF and DKK3. As may be observed in figure 6, both cell lines show downregulation of DKK3 on protein-level. For the NCI-H661 cell line, this correlates with the results from the qPCR, that indicate the downregulation of DKK3 in the presence of PAX6. For the NCI-H460 cell line, this does not correlate with the mean fold change observed from the qPCR results. However, two out of four biological replicates do indeed show downregulation of DKK3 in this cell line, whilst the last two biological replicates show no regulation of DKK3. It is reasonable to assume that PAX6 has regulatory capacity over DKK3, directly or indirectly, in both cell lines, and that the inconsistent results from the qPCR for the NCI-NCI-H460 cell line is due to some of the challenges described earlier. Figure 9 show that also CTGF is downregulated by PAX6 on protein-level. Again, this correlates with the qPCR results for the NCI-H661 cell line, which show downregulation of CTGF on gene-level, but does not correlate with the qPCR results from the NCI-H460 cell line, which show no regulation. For this gene, only one out of five biological replicates suggests this gene to be downregulated in the NCI-H460 cell

line. However, there are additional regulation phenomena happening between transcription and translation, therefore qPCR folds can never be directly trusted as indications of protein regulation. The CTGF protein has an expected molecular weight of 36-42 kDa, but figure 11 indicate that the protein suspected to be CTGF has a molecular weight of 65 kDa in the NCI-H460 cell line. The assumption is that this is a highly glycosylated form of the protein, and maybe even a product of dimerization. If this is not a post-transcriptional modified form of CTGF, it is an unspecific antibody binding to something else that is regulated by PAX6, which is quite unlikely. Because of available antibodies, a single experiment was also performed using antibodies against ANG3 (figure 8). ANG3 was one of the genes that produced very high Ct-values on the qPCR, and therefor had to be excluded from the results. There are perhaps a slight indication of that PAX6 upregulates this gene, but the difference is miniscule.

The co-analysis of regulated genes detected by comparative qPCR with its corresponding protein is crucial for the validity of such experiments. But as this study has demonstrated, there are potential pit-falls which need to be avoided. Good correlation between gene regulation and protein regulation for several targets would have provided solid evidence of the true regulatory capacity of PAX6, either as a direct regulator or as a mediator in indirect regulation.

### **Real-time monitoring of cells**

For this thesis, two different systems where used for the real-time monitoring of cells; the xCelligence system and the IncuCyte system. These systems use different approaches in the monitoring of cell proliferation and migration, but only the IncuCyte is capable of monitoring cell death via apoptosis.

Both systems seem to indicate that PAX6 promotes proliferation for the NCI-H460 cell line (figure 12, 13, 23, 24). Only one proliferation experiment is available for the NCI-H661 cell line (figure 21). This experiment was performed on the xCelligence system, and it appears that PAX6 inhibits proliferation in this cell line. When studying the graph, however, it becomes apparent that this was not an optimal experiment. A massive drop in cell index after the adding of transfection mix, and later, media change, makes the normalization of this experiment unreliably. This, together with the fact that this is the only available experiment for this cell line, makes it unreasonable to make any conclusions as to the proliferative effects that PAX6 may have on the NCI-H661 cell line.



For the migration study, both systems indicate that PAX6 inhibits migration in both NCI-H460 and NCI-H661 (figure 15, 16, 17). For the NCI-H460 cell line, only one experiment with the xCelligence system is available for the migration study (figure 17), but the design of this experiment makes the result highly credible. There are two sets of PAX6 siRNA transfected and SCR siRNA transfected cells in this experiment. One set has media containing serum as a chemo attractant in the lower chamber, whilst the other set has serum-free media in the lower chamber. After approximately 70 hours, PAX6 knockdown cells start to migrate towards the chemo attractant (media with serum), whilst the SCR siRNA transfected cells does not migrate towards the media containing serum. Both the PAX6 siRNA transfected and the SCR siRNA transfected cells with serum-free media in the lower chamber did not migrate. This indicates that in order for the NCI-H460 cells to migrate, they are dependent on a chemo attractant and decreased levels of PAX6. This is not implying that PAX6 is the master regulator of migration for this cell line, but it shows that PAX6 is one factor that has clear effect on migration. For the NCI-H661 cell line, two migration experiments was analysed on the xCelligence system, and one migration experiment were analysed on the IncuCyte system. All three experiments suggest that PAX6 inhibits migration in NCI-H661 (figure 15, 16, 20). The two systems use a very different approach in the measurement of migration. The IncuCyte system measures the migration of cells into a scratch wound, whilst the xCelligence system measures chemotaxis-driven migration through a porous membrane. The NCI-H661 cells were shown to migrate regardless of PAX6-status in the IncuCyte system, but the presence of PAX6 slows down the migration rate. The NCI-H460 cells do not migrate when expressing PAX6, and only migrate along the serum gradient when PAX6 expressing is quenched. This could result in NCI-H460 cells not migrating under the conditions provided by the IncuCyte, regardless of PAX6-status, since there is no chemoattractive gradient present in this system. To summarise, we have shown that PAX6 regulates NSCLC cell migration, yet this effect varies depending on the cell lines biological properties.

The study of cell death by apoptosis is a feature only available for the IncuCyte system. One experiment for each cell line was performed, and for both cell lines the presence of PAX6 appears to inhibit apoptosis (figure 21 and 22). For the NCI-H661 cell line, the different rate of apoptosis between PAX6 siRNA transfected cells and SCR siRNA transfected cells becomes apparent after approximately 30 hours, when cultures are about 50% confluent. For the NCI-H460 cell line, the apoptosis has a sudden onset after approximately 100 hours, with cells expressing PAX6 displaying

a slower rate of apoptosis. For this cell line, the cell cultures were close to 100% confluent when apoptosis was initiated.

Both the xCelligence and the IncuCyte are powerful systems when it comes to monitoring the behaviour of cells in real-time, but personally I the IncuCyte system to be the best. Despite the somewhat limitation in regard to the migration study compared with the xCelligence, it is superior when it comes to capacity and the numerous possible different applications it possesses. In particular, the system allows use of various dishes and plates, does not require expensive custom-produced plates with electrodes, making it a flexible and cheap system. Very importantly, a researcher can always refer to the camera shots for each and every well, providing perfect control over what exactly happens with the cells (morphology changes, apoptosis, infections, etc). Such a tight control is impossible in the xCelligence system. Unfortunately, the IncuCyte system was only available for a very short period of time during this master degree study, so its potential was not fully exploited.

### **Relevance of findings**

This study successfully identifies some potential target genes of the transcription factor PAX6 relevant for non-small cell lung cancer. The experiments involved the lung cancer cell lines NCI-H460 and NCI-H661. It is clear that PAX6 has regulatory effects on the identified genes, but if these genes are regulated directly by PAX6 or via alternative pathways where PAX6 is involved, remains unclear. It is difficult to make a clear association between regulated genes and the cellular behaviour observed using the real-time monitor systems. In this study, PAX6 downregulates DKK3 in both cell lines (on protein level). Downregulation of DKK3 has been shown to induce apoptosis in lung adenocarcinoma [45], but in this study the effect seems to be the opposite, as cells expressing PAX6, and hence has downregulated DKK3 expression, shows a lower degree of apoptosis. High expression of CTGF is associated with suppression of cell proliferation and signalling transduction in NSCLC [46], and to inhibit metastasis and invasion of human lung adenocarcinoma [47]. Our study shows that PAX6 downregulates CTGF (on protein level) in both lung cancer cell lines. The results from the migration study imply that PAX6, and hence downregulated amount of CTGF, inhibits migration. The proliferation study associate PAX6, and hence downregulated amounts of CTGF, with increased proliferation. The latter observation supports the findings described in the literature [46].

Several genes associated with positive survival were also identified as targets for PAX6. These include upregulation of the well-known tumor suppressor PTEN, downregulation of one of the genes encoding a ligand associated with Wnt (WNT2b), downregulation of VEGFR3 (promotes angiogenesis) and also upregulation of the Wnt antagonist SFRP2. These discoveries support the unpublished results by Kiselev and Busund, which report a positive correlation between PAX6 and survival in non-small cell lung cancer patients.

Even though the fold-changes for many of the regulated genes are modest, it is important to be aware of that for many transcriptions factors such as PAX6, or the more famous MYC, rather moderate fold changes are usually seen adequate to propose existence of regulatory association.

There are of course a multitude of possible explanations and alternative regulated pathways that can account for the discrepancies observed when comparing results and studies. These are, as stated earlier, highly dynamic, biological systems with immense molecular interactions, and to present a statement on the basis of variations observed on single events, would be unwise. However, the sets of genes which were shown to be regulated by PAX6 in this project have plausible relevance for lung cancer biology and may in part provide mechanistical explanation of PAX6's biological effects in lung cancer.

## **Future perspective**

A lot more research on the transcription factor PAX6 role in non-small cell lung cancer progression is necessary to reveal its true role in this type of cancer. The identification of more cancer associated target genes is crucial in this aspect. The possibility presented by real-time monitoring of cells, is a very valuable tool in studying the biological effects that different genes have in different cell lines. The discovery of more target genes together with real-time monitoring of cellular response to manipulation of these genes, in several cell lines, should be a priority in future experiments. Another very valuable tool would have been the use of a laser micro-dissection method performed on formalin fixed paraffin embedded tissue sections. This would have allowed cell collection from the adjacent tumour regions exactly where cells with PAX6 and their very neighbours without PAX6 resided. These cells could have been processed into RNA-cDNA, and used for comparative qPCR. Such approach has been successfully used by other groups, but it is a technically demanding and time consuming method. Advantage of this method is that it allows studying the transcriptome of "real cancer cells" - meaning malignant cells in clinical samples. This is in contrast to the well-known weakness of studies based on cell lines, as they are to a certain extent artificial systems, potentially rich in artefacts.

As well, there is a clear need to confirm regulation of the candidate target genes on protein level by means of Western blot and/or in-cell Western (for higher throughput and lower costs) and/or confocal microscopy of immunostained cells, to look deeper into possible protein localisation changes. A pilot study was performed to investigate the usefulness of in-cell western, but due to the limited amount of time we were not able to test this method thoroughly. A figure showing the result from the pilot study is included in appendix 1. Data from ICW analysis might potentially be more meaningful than data derived from traditional western blot because proteins are detected in their cellular context, yet proper specificity controls are essential.

## References

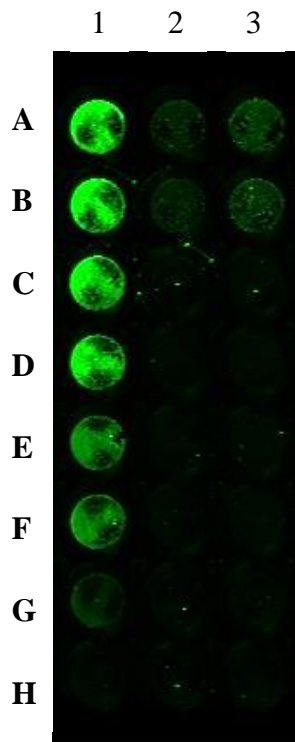
1. Weinberg RA: **The biology of cancer**. New York: Garland Science; 2007.
2. **Cancer** [<http://www.who.int/mediacentre/factsheets/fs297/en/>]
3. Travis WD, World Health Organization., International Agency for Research on Cancer., International Association for the Study of Lung Cancer., International Academy of Pathology.: **Pathology and genetics of tumours of the lung, pleura, thymus and heart**. Lyon  
Oxford: IARC Press  
Oxford University Press (distributor); 2004.
4. Molina JR, Yang P, Cassivi SD, Schild SE, Adjei AA: **Non-small cell lung cancer: epidemiology, risk factors, treatment, and survivorship**. *Mayo Clinic proceedings Mayo Clinic* 2008, **83**(5):584-594.
5. Temel JS, Greer JA, Muzikansky A, Gallagher ER, Admane S, Jackson VA, Dahlin CM, Blinderman CD, Jacobsen J, Pirl WF *et al*: **Early palliative care for patients with metastatic non-small-cell lung cancer**. *The New England journal of medicine* 2010, **363**(8):733-742.
6. Travis WD, Travis LB, Devesa SS: **Lung cancer**. *Cancer* 1995, **75**(1 Suppl):191-202.
7. **American Cancer Society - What is Non-Small Cell Lung Cancer** [<http://www.cancer.org/cancer/lungcancer-non-smallcell/detailedguide/non-small-cell-lung-cancer-what-is-non-small-cell-lung-cancer>]
8. Salgia R, Hensing T, Campbell N, Salama AK, Maitland M, Hoffman P, Villaflor V, Vokes EE: **Personalized treatment of lung cancer**. *Seminars in oncology* 2011, **38**(2):274-283.
9. West L, Vidwans SJ, Campbell NP, Shrager J, Simon GR, Bueno R, Dennis PA, Otterson GA, Salgia R: **A novel classification of lung cancer into molecular subtypes**. *PloS one* 2012, **7**(2):e31906.
10. Hirsch FR, Scagliotti GV, Langer CJ, Varella-Garcia M, Franklin WA: **Epidermal growth factor family of receptors in preneoplasia and lung cancer: perspectives for targeted therapies**. *Lung cancer* 2003, **41 Suppl 1**:S29-42.
11. Ludovini V, Bianconi F, Pistola L, Chiari R, Minotti V, Colella R, Giuffrida D, Tofanetti FR, Siggillino A, Flacco A *et al*: **Phosphoinositide-3-kinase catalytic alpha and KRAS mutations are important predictors of resistance to therapy with epidermal growth factor receptor tyrosine kinase inhibitors in patients with advanced non-small cell lung cancer**. *Journal of thoracic oncology : official publication of the International Association for the Study of Lung Cancer* 2011, **6**(4):707-715.
12. Sattler M, Reddy MM, Hasina R, Gangadhar T, Salgia R: **The role of the c-Met pathway in lung cancer and the potential for targeted therapy**. *Therapeutic advances in medical oncology* 2011, **3**(4):171-184.
13. Kim ES, Salgia R: **MET pathway as a therapeutic target**. *Journal of thoracic oncology : official publication of the International Association for the Study of Lung Cancer* 2009, **4**(4):444-447.
14. Pidgeon GP, Barr MP, Harmeij JH, Foley DA, Bouchier-Hayes DJ: **Vascular endothelial growth factor (VEGF) upregulates BCL-2 and inhibits apoptosis in human and murine mammary adenocarcinoma cells**. *British journal of cancer* 2001, **85**(2):273-278.
15. Kwak EL, Bang YJ, Camidge DR, Shaw AT, Solomon B, Maki RG, Ou SH, Dezube BJ, Janne PA, Costa DB *et al*: **Anaplastic lymphoma kinase inhibition in non-small-cell lung cancer**. *The New England journal of medicine* 2010, **363**(18):1693-1703.

16. Zhang X, Zhang S, Yang X, Yang J, Zhou Q, Yin L, An S, Lin J, Chen S, Xie Z *et al*: **Fusion of EML4 and ALK is associated with development of lung adenocarcinomas lacking EGFR and KRAS mutations and is correlated with ALK expression.** *Molecular cancer* 2010, **9**:188.
17. Treisman J, Harris E, Desplan C: **The paired box encodes a second DNA-binding domain in the paired homeo domain protein.** *Genes & development* 1991, **5**(4):594-604.
18. Balczarek KA, Lai ZC, Kumar S: **Evolution of functional diversification of the paired box (Pax) DNA-binding domains.** *Molecular biology and evolution* 1997, **14**(8):829-842.
19. Dahl E, Koseki H, Balling R: **Pax genes and organogenesis.** *BioEssays : news and reviews in molecular, cellular and developmental biology* 1997, **19**(9):755-765.
20. Kozmik Z: **Pax genes in eye development and evolution.** *Current opinion in genetics & development* 2005, **15**(4):430-438.
21. Czerny T, Busslinger M: **DNA-binding and transactivation properties of Pax-6: three amino acids in the paired domain are responsible for the different sequence recognition of Pax-6 and BSAP (Pax-5).** *Molecular and cellular biology* 1995, **15**(5):2858-2871.
22. Dames P, Puff R, Weise M, Parhofer KG, Goke B, Gotz M, Graw J, Favor J, Lechner A: **Relative roles of the different Pax6 domains for pancreatic alpha cell development.** *BMC developmental biology* 2010, **10**:39.
23. Epstein JA, Glaser T, Cai J, Jepeal L, Walton DS, Maas RL: **Two independent and interactive DNA-binding subdomains of the Pax6 paired domain are regulated by alternative splicing.** *Genes & development* 1994, **8**(17):2022-2034.
24. Chauhan BK, Zhang W, Cveklova K, Kantorow M, Cvekl A: **Identification of differentially expressed genes in mouse Pax6 heterozygous lenses.** *Investigative ophthalmology & visual science* 2002, **43**(6):1884-1890.
25. Chauhan BK, Yang Y, Cveklova K, Cvekl A: **Functional properties of natural human PAX6 and PAX6(5a) mutants.** *Investigative ophthalmology & visual science* 2004, **45**(2):385-392.
26. Gosmain Y, Katz LS, Masson MH, Cheyssac C, Poisson C, Philippe J: **Pax6 is crucial for beta-cell function, insulin biosynthesis, and glucose-induced insulin secretion.** *Molecular endocrinology* 2012, **26**(4):696-709.
27. Lee TI, Young RA: **Transcription of eukaryotic protein-coding genes.** *Annual review of genetics* 2000, **34**:77-137.
28. Darnell JE, Jr.: **Transcription factors as targets for cancer therapy.** *Nature reviews Cancer* 2002, **2**(10):740-749.
29. Wisdom R, Johnson RS, Moore C: **c-Jun regulates cell cycle progression and apoptosis by distinct mechanisms.** *The EMBO journal* 1999, **18**(1):188-197.
30. Brivanlou AH, Darnell JE, Jr.: **Signal transduction and the control of gene expression.** *Science* 2002, **295**(5556):813-818.
31. Lord-Grignon J, Abdouh M, Bernier G: **Identification of genes expressed in retinal progenitor/stem cell colonies isolated from the ocular ciliary body of adult mice.** *Gene expression patterns : GEP* 2006, **6**(8):992-999.
32. Mayes DA, Hu Y, Teng Y, Siegel E, Wu X, Panda K, Tan F, Yung WK, Zhou YH: **PAX6 suppresses the invasiveness of glioblastoma cells and the expression of the matrix metalloproteinase-2 gene.** *Cancer research* 2006, **66**(20):9809-9817.
33. Zhong X, Li Y, Peng F, Huang B, Lin J, Zhang W, Zheng J, Jiang R, Song G, Ge J: **Identification of tumorigenic retinal stem-like cells in human solid retinoblastomas.** *International journal of cancer Journal international du cancer* 2007, **121**(10):2125-2131.

34. Muratovska A, Zhou C, He S, Goodyer P, Eccles MR: **Paired-Box genes are frequently expressed in cancer and often required for cancer cell survival.** *Oncogene* 2003, **22**(39):7989-7997.
35. Osumi N, Shinohara H, Numayama-Tsuruta K, Maekawa M: **Concise review: Pax6 transcription factor contributes to both embryonic and adult neurogenesis as a multifunctional regulator.** *Stem cells* 2008, **26**(7):1663-1672.
36. Chang JY, Hu Y, Siegel E, Stanley L, Zhou YH: **PAX6 increases glioma cell susceptibility to detachment and oxidative stress.** *Journal of neuro-oncology* 2007, **84**(1):9-19.
37. Zhou YH, Hu Y, Mayes D, Siegel E, Kim JG, Mathews MS, Hsu N, Eskander D, Yu O, Tromberg BJ *et al*: **PAX6 suppression of glioma angiogenesis and the expression of vascular endothelial growth factor A.** *Journal of neuro-oncology* 2010, **96**(2):191-200.
38. Lang D, Mascarenhas JB, Powell SK, Haleboua J, Nelson M, Ruggeri BA: **PAX6 is expressed in pancreatic adenocarcinoma and is downregulated during induction of terminal differentiation.** *Molecular carcinogenesis* 2008, **47**(2):148-156.
39. Liu RZ, Monckton EA, Godbout R: **Regulation of the FABP7 gene by PAX6 in malignant glioma cells.** *Biochemical and biophysical research communications* 2012, **422**(3):482-487.
40. Mita R, Coles JE, Glubrecht DD, Sung R, Sun X, Godbout R: **B-FABP-expressing radial glial cells: the malignant glioma cell of origin?** *Neoplasia* 2007, **9**(9):734-744.
41. Kaloshi G, Mokhtari K, Carpentier C, Taillibert S, Lejeune J, Marie Y, Delattre JY, Godbout R, Sanson M: **FABP7 expression in glioblastomas: relation to prognosis, invasion and EGFR status.** *Journal of neuro-oncology* 2007, **84**(3):245-248.
42. Dalby B, Cates S, Harris A, Ohki EC, Tilkins ML, Price PJ, Ciccarone VC: **Advanced transfection with Lipofectamine 2000 reagent: primary neurons, siRNA, and high-throughput applications.** *Methods* 2004, **33**(2):95-103.
43. Livak KJ, Schmittgen TD: **Analysis of relative gene expression data using real-time quantitative PCR and the 2(-Delta Delta C(T)) Method.** *Methods* 2001, **25**(4):402-408.
44. Holmes K, Roberts OL, Thomas AM, Cross MJ: **Vascular endothelial growth factor receptor-2: structure, function, intracellular signalling and therapeutic inhibition.** *Cellular signalling* 2007, **19**(10):2003-2012.
45. Jung IL, Kang HJ, Kim KC, Kim IG: **Knockdown of the Dickkopf 3 gene induces apoptosis in a lung adenocarcinoma.** *International journal of molecular medicine* 2010, **26**(1):33-38.
46. Chien W, Yin D, Gui D, Mori A, Frank JM, Said J, Kusuanco D, Marchevsky A, McKenna R, Koeffler HP: **Suppression of cell proliferation and signaling transduction by connective tissue growth factor in non-small cell lung cancer cells.** *Molecular cancer research : MCR* 2006, **4**(8):591-598.
47. Chang CC, Shih JY, Jeng YM, Su JL, Lin BZ, Chen ST, Chau YP, Yang PC, Kuo ML: **Connective tissue growth factor and its role in lung adenocarcinoma invasion and metastasis.** *Journal of the National Cancer Institute* 2004, **96**(5):364-375.
48. Cen H, Mao F, Aronchik I, Fuentes RJ, Firestone GL: **Devd-Nucview488: A Novel Class of Enzyme Substrates for Real-Time Detection of Caspase-3 Activity in Live Cells.** *FASEB J* 2008, **22**(7):2243-2252.

## APPENDIX 1

### In-Cell western experiment



**Figure 23: In Cell Western – H460 cells.** Anti-TF in A1-A3 and B1-B3. Anti-VEGFA in C1-C3 and D1-D3. Anti-P53 in E1-E3 and F1-F3. Anti-VEGFC in G1-G3 and H1-H3. Primary antibody dilution in A1-A3, C1-C3, E1-E3 and G1-G3: 1:300. Primary antibody dilution in B1-B3, D1-D3, F1-F3 and H1-H3: 1:600. Secondary antibody dilution in A1-H1: 1:500, A2-H2: 1:1000 and A3-H3: 1:2000.